

27 YEARS OF RADIO RELIABILITY

CONCORD



1948 - Catalog No. 9-47

TELEVISION • RADIOS • RADIO PARTS • AMPLIFIERS • TESTERS • ELECTRONIC EQUIPMENT



CONCORD RADIO

C O R P O R A T I O N

CHICAGO 7, ILL. ☆ ATLANTA 3, GA.
901 W. JACKSON BLVD. 265 PEACHTREE STREET

Formerly LAFAYETTE RADIO CORP.



*Distinctive
Styling
by
Concord*

**New Chairside Phonograph-Radio
with Precision Automatic Record Changer**

Its inspired styling—its exciting performance—PLUS its amazingly low price—all combine to make this new Automatic Phono-Radio Combination the year's most thrilling value. The luxurious mahogany chairside cabinet blends perfectly into both modern and traditional surroundings. The convenience of its unusual slide-top cabinet adds all the more to your complete enjoyment of the best in recorded and radio entertainment. Here is truly the whole world of music, news, sports and drama at your fingertips. Yes—for beauty, performance and convenience—here is the ultimate in a moderately priced Radio-Phonograph Combination. For untold hours of listening pleasure, enjoy this outstanding set in your own home.

THE RADIO: Six tubes (including rectifier) AC Superheterodyne. Four watts of undistorted output for radio reception or record playing. Tunes Broadcast Band and

Short Wave 9 to 15.5 Megacycles. Large slide rule dial. Bass Boost circuit. Large PM Dynamic speaker with Alnico magnet assures fidelity of reproduction. Variable tone control for records and radio.

THE RECORD CHANGER: Completely Automatic, plays ten 12" or twelve 10" records at one loading—gently, safely—handling records with cushioned ease. Lightweight tone arm and the latest in crystal pick-ups, with new "Floating Point" Needle, reduces surface noise and record wear. Allows for manual playing.

Available in Regular Mahogany, and Blond Mahogany. Specify finish when ordering. Shpg. wt. 63 lbs. Entire cabinet measures 27x26³/₄x15¹/₄". For operation on 105-125 volts, 60 cycle AC only.

Model I-602—Mahogany..... \$109.50
Model I-603—Blond Mahogany..... 119.50

Copyright 1947 Concord Radio Corp., Chicago, Ill. Printed in U.S.A.

Console Tone!

- AC-DC
VERSATILITY
- UNBELIEVABLE
LOW PRICE



Concord FM-AM TABLE MODEL

AC or DC Superhet!

Now—for the first time—you get all the exciting advantages of radio's newest miracle development, FM (Frequency Modulation), plus regular AM broadcasts in one compact table model radio for only \$29.95. As you read the amazing new engineering features packed into this set, you'll see in an instant why it is astounding the entire radio world. Here is the FM radio set you have been waiting for! You get all the rich, glorious high fidelity musical beauty of FM—with sensitivity and selectivity you've come to expect only in the most expensive receivers. Here is a table model radio with the newest discoveries of radio engineers. Only Concord engineering genius could bring you all these radio features at such a low, value-giving price.

New Miniature Tubes are employed in a powerful, amazingly efficient circuit. Provide high sensitivity with razor sharp selectivity. Tubes used are: 12BE6 Converter, 12BA6 I.F. Amplifier, 12AT6 2nd detector and 1st audio, 12AT7 Super-regeneration converter and oscillator, 35B5 Output tube and 35W4 Rectifier. Top quality transformers and coils assure peak efficiency with virtually no drift on FM band.

Large Slide Rule Dial with smooth reduction gear drive. Tunes broadcast band—530 to 1650 kilocycles. FM band—88 to 108 megacycles.

Built-In Loop Antenna. Extra large for maximum AM signal strength. Provision for FM antenna also.

Wide Range Reproduction. New full size Electro-Dynamic Speaker. Full, rich quality. Full range tone control. R.C.A. and HAZELTINE licensed.

Model 1-606. Operates on 105-125 volts, 50-60 cycle, AC or DC. Shipping weight 15 pounds. **\$29.95**
Your Cost, in lots of 3
Your Cost, each, \$32.50

Adapter for operating set from 220 volts AC or DC. C5243 \$1.41

Full Size

Table Model Superhet

- ★ Powerful Superhet Circuit
- ★ Top Quality 6-inch Speaker
- ★ Three Watts Audio Output
- ★ Mahogany Finished Cabinet

Here's perfection of tone usually possible only in large console sets. Outstanding engineering and design, an extra large speaker and plenty of cabinet baffle space does the trick. Radio experts—dealers, engineers, servicemen—will spot this radio in a hurry for its sensational performance and superb value. More tubes, efficient speaker, advanced design features, thorough testing—all these "extras" add up to a grand thrill in listening satisfaction.

High Undistorted Output: Three watts. Comparable to pre-war consoles. More than TWICE that of most comparable AC-DC sets.

Continuously Variable Tone Control: Deep throated bass to clear toned treble—the kind of tone you would normally expect only from an expensive console radio.

Superheterodyne Circuit: Advanced design, licensed by RCA laboratories with 6 tuned circuits. Uses: 6SA7, 6SF7, 6SL7, two 25L6 and two 25Z6 tubes.

540-1700 KC Standard American Broadcast and Police Calls.

High Quality 6-inch Speaker: With large Alnico V Magnet for sparkling clarity and resonance of tone.

Built-In Antenna: No outside wires. Plug in and play. Connections for outside antenna if desired.

Automatic Volume Control. Inverse Feedback: Eliminates overloading, reduces distortion and hum.

Artistic Cabinet: Exquisitely styled, beautifully proportioned with simple elegance. Rust-proof metal mesh grille adds a distinctive touch. Cabinet finished in a hand rubbed high gloss mahogany. Size 14 inches by 10 inches by 8 inches.

Model 1-700. Operates on 105-125 volts, 50-60 cycle AC or DC. Shpg. wgt. 13 lbs. List price \$44.95

Your Cost, each, in lots of 3 **\$22.95**

Your Cost, each, in single lots \$24.95

Adapter for operating set from 220 volts AC or DC. C5243 \$1.41

NOISELESS STATICLESS FREQUENCY MODULATION





YOUR

27 *Years* of Radio Reliability

Radio is a highly technical field where the knowledge and experience of your supplier is your best guarantee of quality and value. Consequently it pays to deal with an old established supplier . . . one who has **EARNED** the loyalty of customers through years of delivering the best equipment and service at lowest prices. Back of every item listed in this catalog stands a mighty institution founded on 27 years of experi-

ence and success in serving the complete needs of more than 500,000 customers in every branch of Radio and Electronics. Today . . . as for more than a quarter century . . . the Concord organization is geared to serve you best in **ALL** your radio needs. We invite you to join the half-million radio equipment buyers who **KNOW** they can always depend on Concord for topmost quality at lowest prices.

THE CONCORD GUARANTEE

Every item listed in this catalog is guaranteed to conform with the standards of the Radio Manufacturers' Association, and to perform in the manner intended

for such apparatus. You must be satisfied completely with what you buy. Otherwise you can return it for exchange, repair or refund.

CHICAGO 7, ILL.

901 W. Jackson Blvd. • Phone Haymarket 0422
229 W. Madison St. • Phone Central 5971

You Enjoy Special Advantages When



FAST SERVICE

Same day shipment of every available item is a "must" in the huge, completely-stocked Concord warehouses—centrally located in **CHICAGO** and in **ATLANTA**. Here huge and varied stocks—thousands and thousands of essential radio and electronic needs—await the arrival of your order, to be selected, inspected, packed and shipped—whenever possible—within 24 hours. To avoid delay—order today from **CONCORD**.

Radio

and Electronic Headquarters

Concord's three huge warehouses . . . centrally located in Chicago and Atlanta . . . stock thousands upon thousands of items of Radio and Electronic equipment . . . everything necessary to serve you completely. Central location of our warehouses assures fastest possible delivery to you. Check this catalog carefully. In it you will find such famous radio names as Hallicrafters, Mallory, Amphenol, RCA, General Electric, Hammerlund, Jensen, Burgess, Weston, Ohmite, IRC, Thordarson, Reliance and many others . . . PLUS CONCORD'S own specially-built parts and equipment. Here you'll find your every need in radio and electronics . . . at the lowest possible prices.

Consult Concord's Technical Advisory Service

No matter what your interest in radio and electronics—whether it be for profit or pleasure—Concord is your prime source of top-quality Radio and Electronic equipment.

LABORATORIES: Men experienced in your problems and with the equipment you use will give you expert advice on what Concord equipment will solve your needs.

SOUND DEPARTMENT: Concord Sound Engineers are equipped to offer latest information and advice about PA Systems, Inter-Communication Systems, etc.

EXPERIMENTERS: Concord's own full-time experimenters can help you solve your problems . . . can give you the latest dope on new techniques, new equipment.

INSTITUTIONS: Years of catering to the needs of institutions has made our Institutional Department the last word in the field. Try us on your intricate problems.

AMATEUR DEPARTMENT: Concord employs scores of hams, serves thousands. The best of them are at your service to answer questions, advise on equipment, etc.

INDUSTRIAL DEPARTMENT: Concord specializes in the needs of industrial users of radio parts and electronic

equipment. Our trained men stand ready to advise and assist in the selection and installation of radio systems, electronic labor-saving devices, etc.

SCHOOLS: Come to Concord for up-to-the-minute information and advice on the selection and use of training kits, etc. Our School Department knows its field!

BROADCASTING: Concord specialists have saved broadcasters many dollars and many hours by expert recommendation of equipment, supplies and installation techniques.

Each and every one of these specialized Concord departments stands ready to serve you. The advisory service is FREE . . . you are under no obligation to buy when you use it. Simply mail your questions care of the department . . . you will have a courteous, helpful answer as soon as possible. If you have a query which does not fall into any of the above categories, direct your letter to Chief Technical Advisor, Concord Technical Advisory Service. You will receive a prompt and authoritative reply.

Buy Any Home Receiver on 30-DAY FREE TRIAL!

You must be satisfied with the performance of the Concord home radio receiver you buy from Concord. That is why we say: "Buy and try the receiver of your choice in your own home. Give it every test of performance. Then, at any point during the 30 day period, unless you are completely satisfied, return the set to Concord for full refund or credit less transportation charges. No company can make a fairer offer.

Time Payment Plan Available

Those interested in purchasing equipment on convenient monthly installments should write for additional details of our time payment plan. Learn how you NOW can have Communication Receivers, Amplifiers, Test Equipment, Radios, Phono-Radios, etc., with a small down payment. SERVICE-MEN! Find out how your limited capital can bring you bigger profits with CONCORD'S easy time payment plan.

ATLANTA 3, GA. 265 Peachtree St. • Phone Walnut 5140

You Order from CONCORD by Mail!

FINEST QUALITY

LOWEST PRICES

BUY BY MAIL



STANCOR
hallicrafters
COMMUNICATIONS-EQUIPMENT



**HIGHEST
QUALITY**



It's Concord for quality—because every item in our vast stock is backed by famous, dependable brand names! Whether your order is large or small, we ship no item until it has passed the rigid inspection of our own or the manufacturers' skilled technicians. Yes, every item Concord accepts for sale must meet the highest standards of performance and reliability, you are sure of receiving the finest quality.

Depend on Concord—for lowest prices consistent with quality that can be relied on for top performance and lasting service. Concord's policy of buying for cash and selling for cash is reflected in the money-saving prices you will see on the pages of this catalog. Whatever your needs in radio and electronic parts and equipment—check Concord prices—order from Concord and SAVE.

The BETTER WAY to save time, money and avoid inconvenience. Order all your radio and electronic needs from this complete Concord catalog—it offers everything you need in Radio and Electronics equipment. You buy what you want—no more, no less. You select from complete assortments—low catalog prices save you money—every item is fully and unconditionally guaranteed—and—you get fast service.



For a New Conception of Listening Pleasure— The Concord CHIPPENDALE—A Custom-

Beyond Compare—Here is the set that is beyond comparison with any other . . . because it is the only complete home instrument made to the commercial studio standards of acoustic laboratories and the reception standards of commercial trans-world communications stations.

Flawless Cabinetry—The distinguished cabinet, of choicest hand-rubbed mahogany veneers, has the rare warmth and charm of really fine furniture. Its lines are simple without being severe, achieving the true elegance of good taste so sought after in interior decoration.

Versatility—Brings the whole magic world of music and drama to your home. Standard broadcast . . . the new static-free high-fidelity FM . . . the entire world of international short wave and amateur stations . . . and superb record reproduction free from needle noise.

Advanced Engineering—New standards of fidelity go far beyond full-range frequency response . . . also provide perfect steep-wave-front transient response and freedom from intermodulation and harmonic distortion . . . right through the receiver . . . amplifier . . . and on out the giant 15-in. Jensen Co-Axial dual speaker, the same principle of sound reproduction used in broadcast studios and the better motion-picture theatres where nothing short of perfect sound reproduction can be tolerated.

Classical or Popular Music—A violin and a trumpet should sound like a violin and a trumpet whether they are being played in a ballroom or a concert hall . . . in both cases you want to hear them realistically . . . and that is exactly what this instrument brings you: room-prosence realism. Music with all the fine shades of tone and the full dynamic range of volume . . . the rich deep basses, the delicate vibrancy of singing strings, the sudden impact of percussions, the clear trills of reeds . . . music that thrills, whether Popular or Classical. In the voice ranges, you hear your favorite radio dramatists as though they were speaking to you from the cabinet . . . you hear every subtle nuance of intonation and the catch in the throat, the sigh that is no more than a slowly released breath, the lilt of laughter. That is what electronic and acoustic engineers have been working to achieve. In this instrument you get the results of their efforts to date.

Automatic Record Playing—The advanced electro-acoustical engineering is matched by the mechanical perfection of the record changer. Slides out for instant loading, or in for concealed playing, at the slightest pressure of your finger tips. The gentle handling accorded your records by this superb changer adds hundreds of playings to the life of each record. Load it with ten 12-inch records or twelve 10-inch records and relax for a long period of uninterrupted listening pleasure. Change your mind about one of your selections if you wish . . . any record may be

rejected at will; or use the changer as a single record player . . . you have complete control at all times.

Smooth Perfection—The changer mechanism is the culmination of all the experience in the art to date. Smooth, sure action. Quiet, powerful constant-speed motor holds its speed to within 3/10 of 1 RPM change whether it is loaded with 1 record or 12. Minimum friction and rumble . . . a ball-thrust bearing carries all the load of both records and turntable itself.

Record-Saving Pickup—Extremely high lateral compliance in the advanced crystal cartridge increases record life enormously and gives true tonal response because the needle follows every bend and turn in the recorded groove, with negligible pressure on the side of the groove. Needle point pressure is only 1/4 ounce . . . your records last indefinitely. The permanent jewel-point needle is radius-rounded and shadow-ramped for perfection. The unique arm suspension insures a smooth gliding action so that the needle follows groove modulation, and enough inertia so the arm does not. Sub-audible arm resonance . . . mechanical vibrations are lost in the arm instead of being amplified by audible mechanical resonance. Wide range . . . electrical output of the pickup reproduces the highest frequencies used in modern recording techniques.

Record Storage—Spacious record storage shelves in the cabinet accommodate large record libraries . . . no need for separate record cabinet unless your collection is unusually extensive.

The Receiver

The CONCORD Name—Here is your assurance of the best in radio reception. Concord is a name known throughout the radio and electronic industry as providing the best in communications engineering for many years. In this model, all the known "bests" in radio circuitry, components, and construction are combined into a home receiver. Concord, too, is a "name brand" . . . to professionals who know and appreciate the highest developments in the communications art.

Simplicity of Operation—Here is a set which any professional would be proud to own . . . and which any teen-ager can operate with greater ease than any other instrument with an FM band!

Push-Button Tuning—There is nothing new about push-button tuning in the AM band, and this set has five buttons for AM station selection . . . and it also has . . . which is new . . . five push buttons for FM tuning! You don't have to tune up to . . . then beyond . . . then come back to center . . . for FM tuning. Select any of five channels, which is more than ample for even the largest metropolitan FM area, merely by pushing a button. This remarkable innovation is made possible by an advanced type of Automatic Frequency Control circuit which electronically tunes to the exact center of any FM channel if the mechanical tuning comes anywhere within the channel.

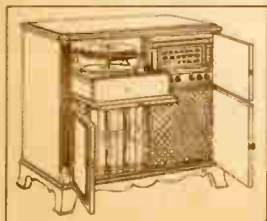



The 15-Tube FM-AM Radio Chassis

Built with all the precision and circuit wizardry of years spent strictly in communications engineering. A brand new kind of receiving instrument designed to fill a long felt need. AM and FM with an overall frequency range of 535 kc to 108 mc in three main bands plus two electrical band-spread dial calibration strips to spread the tuning on the foreign-broadcast 31, 19, and 16-meter bands.

A new development is the addition of 5 push-button tuning controls for FM, made possible by an advanced Automatic Frequency Control circuit incorporated in the separate FM tuner. Five push buttons on the other end of the dial simplify AM tuning as well, and an AM selectivity switch provides choice of high fidelity AM or high adjacent-channel selectivity.

This high quality receiver has numerous applications in homes or wherever a good specialized radio installation is desirable. Styled for beauty, the chassis lends itself perfectly to custom installations of your own choosing, in bookcases, special cabinets, or built-in sound systems for fine homes.

Here is a radio that is all radio, simple to operate, with wide, easily-read dial, separate bass and treble tone controls, and 12 watts of undistorted audio output from an AF channel which is flat from 30 to 15,000 cps.



The Record Changer

Completely automatic or can be operated manually as single record player. Takes up to 10 twelve-inch or 12 ten-inch records at one loading, handles records with utmost gentleness.

Mounted in balanced slide-away drawer, slides in or out with fingertip pressure. Beautifully finished to harmonize with the cabinet. Pickup arm of most advanced design gives you every tone which the recording artists impressed into your record.



The Dual Speaker

Jensen 15" Co-Axial Dual Speaker System with frequency network which passes only the "highs" to the "tweeter" speaker, designed especially to reproduce "highs" with astonishing clarity. The large "woofer" is designed especially for "lows." Together, the two speakers reproduce the entire audible range with a magnificent realism that gives the listener every glorious tone and overtone.

The Ultimate in Luxurious Cabinet Styling

Built 15 Tube FM-AM Phono Radio

Automatic Frequency Control

The AFC circuit in the FM band solves the problem of stability at very high frequencies. At these frequencies, FM tuning requires skill and attention because slight variations in temperature and humidity cause "drift" which ordinarily requires constant re-tuning. FM receivers without AFC require ten minutes, at least, for warm up before the circuits stabilize themselves to some extent. In this advanced receiver, however, the AFC circuit not only finds the exact center of each FM channel, but also holds this center during and after the tube warm-up period.

Band-Spread Tuning

Here is a feature of the best communications receivers . . . electrical band spread . . . brought to you in this unusual home receiver. The three most important foreign-broadcast channels are spread over the length of the large edge-lighted glass slide-rule dial. Record the position of your favorite foreign programs and tune to them easily and quickly without using the hair-line delicacy usually associated with foreign tuning.

Frequency Range

Five separate accurately calibrated dial strips and five band-switch positions give the following frequency coverage:

- Band 1—Broadcast Band. 535 to 1720 kilocycles (kc).
- Band 2—Short Wave and Amateur. Complete coverage between 5.9 and 18.2 megacycles (mc).
- Band 2a—Spread band. 9.0 to 12.0 mc (33½ to 25 meters), the so-called 31-meter foreign broadcast band.
- Band 2b—Spread band. 15.0 to 18.0 mc (20 to 16½ meters), the so-called 19-meter and 16-meter foreign broadcast bands.
- Band 3 —New FM Band. 88 to 108 mc. Uses a completely separate internal tuner and separate tuning knob.

Variable Selectivity

As in the better communications receivers, a switch provides choice of selectivity in the AM bands . . . sharp for adjacent channel separation . . . broad for high fidelity.

Separate Bass and Treble Controls

The human ear is less efficient at low and high frequencies when general volume is reduced to room-level listening. In addition to a treble boost circuit in the audio system which automatically raises the treble level at low general volume levels to compensate for this characteristic of the ear, individual bass and treble controls are provided to make personalized adjustments not only for the listener's ear but also for the acoustic effects peculiar to each room, caused by size, shape, carpeting, drapes, etc.

Receiver Details

Audio output: 12 watts at 500 ohms. AM response: flat 30 to 7500 cps. FM response: flat 30 to 15,000 cps. Oscillator: temperature compensated. IF: dual, 455 kc for AM, 10.7 mc for FM. Tubes: 1—6BA6 RF, 1—6J6 oscillator and AFC, 1—6BE6 mixer, 3—6SQ7 IF's, 1—6SH7 IF amplifier and AM detector, 1—6AL5 FM detector, 1—6J5 AF, 1—6J5 bass amplifier, 1—6SQ7 AF, 1—6SQ7 phase inverter, 2—6V6GT push-pull beam-power amplifiers, 1—5U4G rectifier.

Two Built-In Antennas

Built-in rotatable loop antenna provides adequate normal reception of both standard broadcast and short-wave stations. An FM dipole antenna is attached to the rear of the cabinet. Terminals are provided for external aeriels and grounds for both AM and FM.

Complete Assembly in One Cabinet

There is no other way to get all the advantages of this instrument assembled for you in one cabinet. If you were to purchase all the components separately . . . and have a cabinet of comparative quality built for you . . . the cost would be far greater than the complete, ready-to-operate instrument offered you here. While understandably not in the low price class, this set is surprisingly reasonable considering the quality components it offers the discriminating purchaser. The quality cannot be duplicated at anywhere near this price.

For Custom Installations

This fine receiver chassis and speaker are also available for replacement purposes in your old console . . . or for custom installations in built-in cabinets or in specially built period or modern furniture. The receiver chassis and the Jensen Co-Axial speaker may be purchased as a separate unit. Performance of the receiver in custom surroundings is equal in every respect to the console set pictured above if proper baffle space is given the Co-Axial speaker, according to the instructions furnished.

Cabinet Dimensions—34 inches high, 40 inches wide, 17½ inches deep. **Power Input**—Designed for operation on 105 to 125 volts, 50 to 60 cycle AC. Power drain 100 watts. Chassis size: 15½" long, 15" deep, 9" high. Model 1-1501. 15-tube FM-AM chassis, record changer and Jensen Co-Axial speaker as described above, all mounted in the beautiful Period cabinet shown on the opposite page. Shpg. wgt. 120 lbs. **\$475.00**

Your Cost

Model 1-1500. 15-tube FM-AM chassis and Jensen Co-Axial speaker as described above. Shipping weight 55 pounds. **\$229.50**

Your Cost

Custom Installations

When the need arises for a cabinet other than those pictured here, for custom installations in modern or period pieces . . . in a fireplace cabinet . . . or to replace an obsolete chassis in a favorite cabinet . . . Concord engineers recommend as the finest equipment available, the components of the instruments described below, now available as individual units. For the music lover or connoisseur who desires the ultimate in acoustic-electronic design—or the interior decorator who wants the absolute "tops" for a discriminating client, these are the individual units that will fulfill the expectations of those who are satisfied only with the finest.

The Radio-Phonograph Combi-

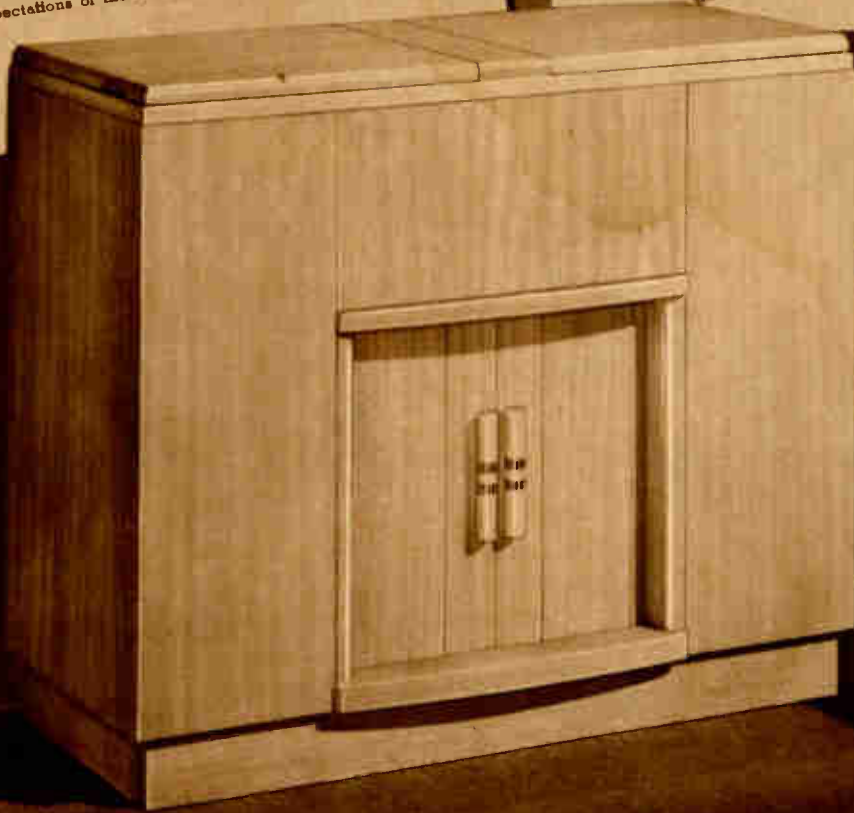

Performance and Tone To Modern and Period Styling

If you are a perfectionist—if you are satisfied only when there is no compromise with quality or performance—this is your radio-phonograph! Offered in either traditional period or modern cabinet styling, this is truly the finest custom assembled radio-phonograph ever created. Each component unit was chosen by Concord engineers only when exhaustive tests had proved it the finest of its kind—the nearest perfect in quality, engineering design and operating superiority. The result is a flawless instrument to delight the eye, the ear and the heart of the most discriminating music lover.

At your command is radio enjoyment such as you have never experienced before. Both standard AM broadcasts and the exciting new high fidelity FM (Frequency Modulation) stations! This is FM reception at its best—clear, strong, static free signals with full wide range tone fidelity. For reproduction of recordings the precision-made imported Garrard automatic unit changes and plays your records with speed, ease and gentleness that is a marvel to observe. And the combination of the famous Concord 15-watt amplifier and matched Jensen Co-Axial speaker recreates both radio and recorded music as faithfully as though the artists were performing in your living room.

This outstanding radio-phonograph combination is ideal for home, club or hotel. Wherever surroundings are distinctive and luxurious, this custom built set will find a warm welcome. Both the modern and period cabinets are illustrated above—but pictures alone can only begin to describe their magnificent styling and careful construction. Only when the console of your choice is installed in your own surroundings can you truly appreciate its dignity and beauty.

In this exceptional instrument for your home—remember, you receive all the benefits of custom construction. Concord engineers were not limited by "assembly line" techniques. Thus, you have a radio-phonograph that contains *all* that is outstanding in the radio art.

On these pages we present important details of each component unit built into this remarkable custom combination set. This equipment is the

product of famous radio manufacturers whose reputation and experience extend back to the very beginning of radio. This is equipment of complete dependability—precision engineered to give you top performance and maximum enjoyment for the years ahead.

If you have promised yourself the *finest obtainable* in a radio-phonograph—here is your answer. By every standard, by applying the most rigid of tests—there is no other instrument which can ever begin to match the Concord "Custom" for quality, performance or value. Here is the one set created for the music lover and the fine radio enthusiast—to satisfy completely his most exacting standards.

THE MODERN CABINET—Here is functional beauty, with full sweeping lines, to mark this striking console as an outstanding example of effective modern styling. The smart natural wood finish is hand rubbed to a lustrous sheen. Craftsmanship is superb—featuring ingenious cabinet design that provides ample room for the equipment, with generous record storage space. A divided lid assures easy access to both radio and automatic record changer. The slide-away doors in front move easily at fingertip pressure. This exceptional console is the supreme touch to your comfortable functional furniture. This cabinet is available as a separate unit. See price on following page. Size: 17½ inches deep, 34 inches high and 40 inches long.

THE PERIOD CABINET—A distinguished console, created for the conventional living room. Truly a beautiful piece of furniture—and a grand achievement of the cabinet-maker's art. Built from the finest hardwoods, the matched mahogany veneers are rich and exquisite. The two spacious doors below open to the large record storage compartment and the loud speaker unit. Burnished brass door pulls add an emphasizing note of beauty. If your home is in the traditional mode, you will cherish this console for many years to come. This cabinet is available as a separate unit. See price on next page. Size: 17½ inches deep, 34 inches high, and 40 inches long.

nation Supreme—Featuring The Finest Of Quality Components



Delight The Music Lover... For The Distinctive Setting

THE BROWNING TUNER AND POWER SUPPLY. Designed for high fidelity and extreme sensitivity on new FM band (87 to 109 MC) and AM standard broadcast band (540 to 1650 KC). Two entirely different tuners are incorporated on one chassis to assure greatest efficiency and quality output. FM section consists of RF stage, mixer with separate oscillator to eliminate image interference, two stages of IF, two stage cascade-tuner, and discriminator stage. AM section is powerful superheterodyne with added TRF stage for image rejection. Automatic volume control. Large full vision slide rule dial. Separate power supply for hum-free reception.

THE CONCORD 15 WATT AMPLIFIER.—Actually 15 watts represent many times the audio power you will require for ordinary room volume. But this tremendous reserve power gives you flexibility and tonal fidelity impossible with an ordinary audio system. You may vary tone to emphasize bass or treble at will. You may reinforce weak recorded passages. Even at full 15 watt output distortion is held to a negligible 2%. Hum is imperceptible. Inverse feedback circuit design assures amazing fidelity. Amplifier cabinet shown in picture above is not included. For a complete description turn to page 22.

THE JENSEN CO-AXIAL SPEAKER.—A remarkable new development in loud speaker construction. Ideally suited for FM and fine AM receivers, such as the Concord "Custom". Actually two speakers in one—a cone "tweeter" mounted in the cone assembly of the large 15-inch "woofer", each doing a specialized job to assure overall fidelity impossible to obtain with one speaker only or with two speakers of the same type. The assembly includes a built-in electrical network which passes only the high audio frequencies to the "tweeter"—designed especially to reproduce "highs" with truly astonishing clarity. The "woofer"—designed especially for the low audio frequencies—reproduces "lows" so realistically that a drum roll, for example, seems to come from an actual drum in the room. Together, the two speakers reproduce the entire audible range, from 50 to 15,000 cycles per second, with a response so true that many audiences, in actual listening tests, could not distinguish between a concealed live orchestra and its electronic reproduction.

THE GARRARD AUTOMATIC CHANGER.—This is one of the finest, most versatile record changers ever made. It's the new Deluxe "mixer" unit that plays 10-inch and 12-inch records interleaved in any assortment and any combination. The Garrard changer is world famous, imported from England—a fool-proof mechanism of the highest quality. Record changing is performed simply, efficiently and silently. Features a one-ounce high fidelity pickup with frequency response flat from 30 to 8500 c.p.s. The permanent jewel stylus will last for years of normal playing. The motor is silent, powerful, governor controlled. Special spring mounting eliminates vibration.

ORDER YOUR CONCORD CUSTOM COMBINATION FROM THE LISTINGS BELOW

- | | |
|-----------------------------------------------------------------------------------------------------------------------------------------------------------------------------------------------|-----------------|
| Model 1-100. Traditional Period Cabinet Combination complete with Jensen Speaker, Garrard Changer, Browning Tuner and Concord Deluxe 15 Watt Amplifier as described above. Shpg. wt. 150 lbs. | \$525.00 |
| Your Cost | |
| Model 3-100. Traditional Period Cabinet only. Shpg. wt. 65 lbs. | \$195.00 |
| Your Cost | |
| Model 1-101. Modern Cabinet Combination complete with Jensen Speaker, Garrard Changer, Browning Tuner and Concord Deluxe 15 Watt Amplifier as described above. Shipping weight 160 pounds. | \$575.00 |
| Your Cost | |
| Model 3-101. Modern Cabinet only. Shipping weight 90 pounds. | \$225.00 |
| Your Cost | |

SPECIAL DESIGN STUDIO

The services of Concord's Special Design Studio are available for those who desire distinctive cabinets of special design, modern or period, radio installations of an individual character, with remote speakers in more than one room, etc. Write to our Special Design Studio.

**Concord FM-AM
or AM Chassis**

FOR CUSTOM INSTALLATIONS

Concord
FM-AM CHASSIS

For True to Life Tone

It's here at last! The amazing new Concord Chassis that brings you BOTH AM and FM (Frequency Modulation) reception. Designed and built to the most exacting standards, this superb chassis is perfectly suited to the custom installation demanding the ultimate in radio performance. Newest FM ratio detector circuit development gives greater ease of tuning, low noise level, tremendous gain and complete interference elimination. Tuning range covers Broadcast and Police Calls (540 to 1700 kc.) and new FM band (88 to 102 mc.). Superb 11-tube (including rectifier) superheterodyne circuit employs dual and triple purpose tubes to give 15-tube sensitivity and selectivity. Outstanding features include Automatic volume control, 8-inch slide rule dial, Full range Bass and Treble tone control and new permeability tuned IF transformers. Has phono input for record player or automatic changer. 13 watts of high fidelity audio output with large 10-inch PM speaker employing Alnico V magnet combine to assure glorious tone quality and tremendous volume. Has built-in antenna and folded Di-Pole for FM reception. No outside wires needed.

USES NEWEST TUBES including efficient miniature types: 1—6BA6 FM, RF amplifier, 1—7Q7 AM oscillator, Mixer, 1—7AH7 IF amplifier, 1—7AG7 FM detector driver, 1—7A6 FM detector, audio amplifier, inverter, 2—7CS Push-pull amplifiers, 1—5Y3 rectifier.

This excellent chassis may be used in a variety of custom installations—either near the speaker or at a distance. On this page, we illustrate several typical custom applications. In the home, club, office or hotel—anywhere the finest radio reception is desired. Use it in either of the cabinets on the preceding page and you will have a radio with beauty beyond belief in tone and styling.

Combined with any of the record changers listed in this book the 13 watt high fidelity audio output will give you a radio-phonograph that will match the finest anywhere for top quality performance.

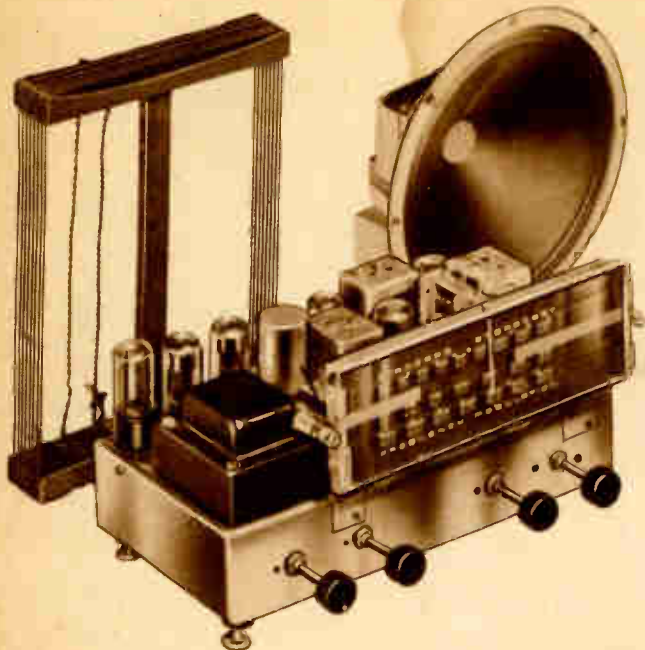

Model 1-1100.—Operates on 105-125 volts AC, 50/60 cycles. Shipping weight 20 pounds. Chassis size: 13 $\frac{3}{4}$ " long, 9" deep, 8 $\frac{7}{8}$ " high. **\$89.50**
Your Cost

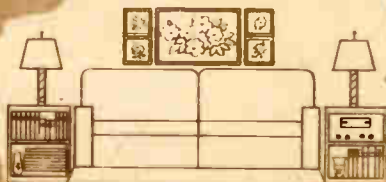

Concord

6 TUBE CHASSIS

You simply won't believe it's possible—a powerful 6-tube, 2-band AC receiver chassis at this unusually low price. But here it is! Another supreme Concord value. This is a set you must play to know truly how much enjoyment is in store for you and your family from the moment you mount it in your favorite cabinet or your new custom installation.

Its sensitive, wonderfully selective circuit covers the domestic broadcast band as well as the popular 19, 25 and 31 meter shortwave bands. So perfect is reception of these stations, you will soon get the "shortwave listening habit." Great volume and full rich tone are yours through this powerful AC chassis with its 4 watts audio output and compensated base response. A phonograph input jack is provided so that a record player or record changer may easily be connected for those music lovers who prefer recorded entertainment. It can also be used to feed output of an FM converter to audio of radio.

The chassis comes complete with built-in antenna and large 6-inch PM speaker with Alnico magnet. The large, easily tuned slide rule dial is as modern as tomorrow—its conservative styling matches any fine custom installation. Improved superheterodyne circuit use 6SA7 mixer, 6SK7 first IF, 6SF7 second IF and second detector, 6SJ7 first AF, 6XSGT rectifier and 6V6GT output. Chassis size: 13" long, 7" deep, 7 $\frac{1}{2}$ " high. This chassis may be used with either the beautiful modern or period console cabinets, illustrated on the preceding pages.

Model 1-601. AC two-band chassis. For operation on 105-125 volts, 50/60 cycle AC. Complete with tubes, speaker, plastic dial escutcheon, antenna, knobs and mounting hardware. Shipping weight 14 pounds.

Your Cost, each, lots of three **\$37.95**
Your Cost, singly **\$39.95**
C1976. Step-down transformer for 220v. AC **\$4.41**

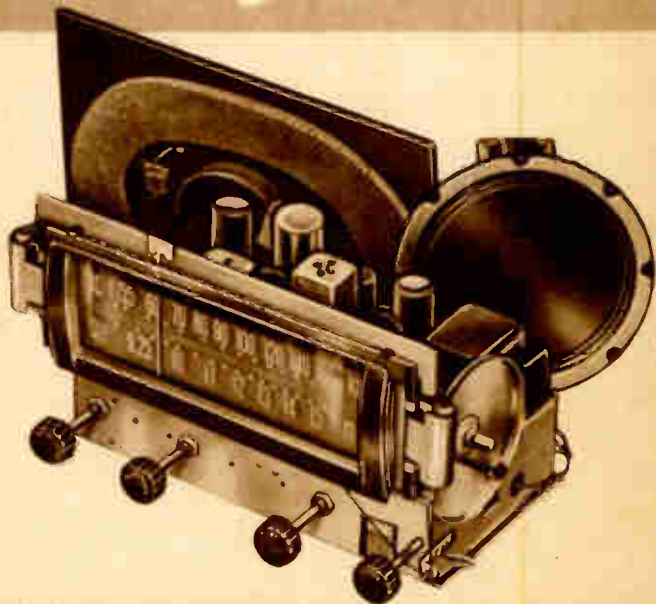

Use this chassis with any of the record players or automatic changers listed in this book for a radio-phonograph combination that is tops in quality and performance and worthy of custom installation anywhere.

Modern As Tomorrow— AUTOMATIC PHONO-RADIO With Reversible Phono Drawer

Here is a Chairside Combination Triumph! An entirely new concept of gracious apartment or small home living—bringing convenience and perfect concert-quality radio and phonograph enjoyment to the arm of your favorite chair. Just look at the smart, functional cabinet lines—the large slide rule dial for complete ease of tuning—and the new reversible Phono Drawer that pulls out of either side of the cabinet. Here is powerful, supersensitive superheterodyne radio reception combined with the most convenient, readily accessible record player of the day. The acoustically correct tone chamber with exclusive Di-Fuse-Tone assures maximum volume and tonal range to all parts of the room. No lid to lift when playing either radio or phonograph. Use the spacious top for books, a lamp or vase of flowers. Thousands of enthusiastic music lovers have been clamoring for a truly modern, superb performing **LOW PRICED** radio-phonograph combination. Now it's here—a beautiful mahogany veneer, hand rubbed functional cabinet with radio and phonograph tonal reproduction rivaled only by the largest, most expensive sets.

AUTOMATIC RECORD CHANGER—Simple and foolproof for quick and smooth operation. Plays ten 12-inch records or twelve 10-inch records with the drawer closed. Crystal pickup, self-starting extra heavy motor, featherweight pressure tone arm. Complete with floating point needle.

AUTOMATIC VOLUME CONTROL—Eliminates fading and blasting. Continuously variable tone control provides deep throated bass to clear-toned treble.

THREE WATTS UNDISTORTED OUTPUT—Push-pull audio circuit brings glorious realism to recorded music and radio reception. Large 8-inch speaker with Alnico V magnet provide true clarity and full resonance of tone.

BUILT-IN ANTENNA—No outside wires. Just plug in and play. Connections for outside aerial provided if one is desired.

POWERFUL SUPERHETERODYNE CIRCUIT—Employs six tuned circuits. Uses 6SA7, 6SF7, 6SL7, two 25L6, and two 25Z6 tubes.

ADDITIONAL FEATURES—Power line filter. Completely shielded chassis, Shock Mounted variable condenser, Hi-Cap filter condensers, Smooth Drive Tuning. Operates on 105-120 volts, 60 cycle AC only. Size: 18 inches and 28 inches by 25 3/4 inches. Shipping weight 78 pounds.

Model 1-702—List Price \$199.50 **\$139.50**
Your Cost

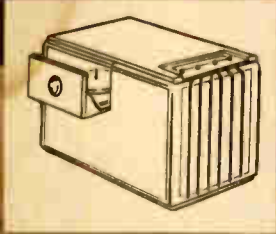

3 Band AC-DC Superheterodyne

- * 2 Short Wave Bands Plus Broadcast Band
- * Built-in Loop Antenna
- * Automatic Volume Control
- * Dual Purpose Tubes

A great thrill awaits you in this new Concord Superheterodyne—for here is a radio designed for your listening pleasure—a radio with features usually found only in high-priced sets—a radio skillfully engineered and made from the finest materials.

The 2 Short-Wave Bands cover 13 to 22 meters and 20 to 50 meters. This gives you full coverage of all of the world's major short wave stations. The regular broadcast band of 540 to 1600 KC makes it easy to get any of your favorite domestic stations.

The Superheterodyne Circuit, employing all of the newest radio discoveries, plus the super-efficient built-in loop antenna, bring you fine reception from stations thousands of miles away. There is a connection for an extra outside aerial, if desired.

The Automatic Volume Control eliminates fading and blasting. The PM Alnico speaker with V magnet gives every program a true-to-life tone.

Uses 5 Tubes including rectifier. Two of these tubes are dual purpose tubes to give you 7-tube performance. Tubes used: 12SK7, 12SA7, 12SQ7, 50L6 and 35Z5 rectifier.

Beautiful Plastic Ivory or Brown Cabinet is 9 1/4 inches long, 6 inches high and 5 1/2 inches deep. The large illuminated dial makes tuning easy, even on closely spaced foreign short wave stations.

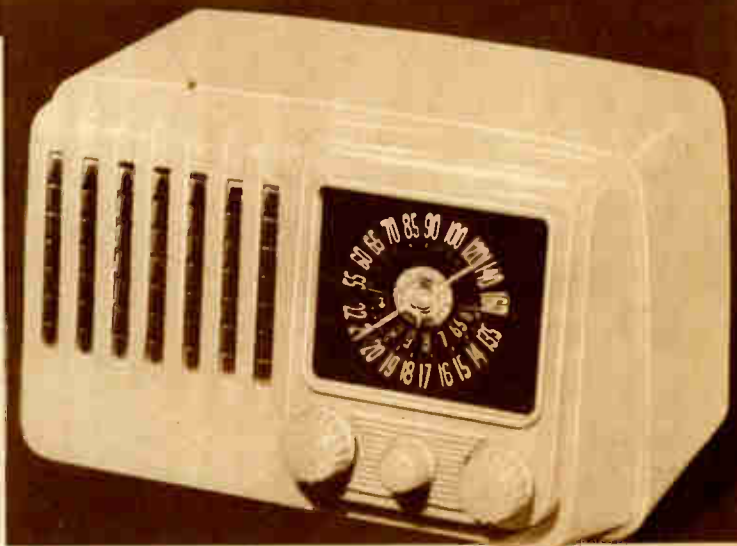

Model 1-508. Brown Plastic. Operates on 105-125 volts, 50-60 cycle, AC-DC. Shipping weight 6 pounds. **\$26.95**
Your Cost, each, in lots of 3 \$28.95
Your Cost, in single lots **\$27.95**
Model 1-507. Ivory Plastic. Same as above. Shpg. wgt. 6 pounds. **\$29.95**
Your Cost, each, in lots of 3 \$29.95
Your Cost, in single lots \$1.41
C5243. Adapter for operating set from 220 volts AC or DC

Concord

AC-DC Superhet A Real Value!

Here's more value for your radio dollars than you ever dreamed possible. Outside, the ultra modern cabinet is an inspiration in gleaming Ivory or Brown plastic. Inside, a host of outstanding new circuit features—employing finest quality components bring in favorite programs with tonal quality and clarity of reception to delight the most critical ear. Here is supreme value in an AC-DC table model superhet set. For here is a radio that will give years of pleasure as the main set in your home or as the "extra radio" for kitchen, bedroom or office.

SUPERHETERODYNE CIRCUIT—An improved superhet circuit, condenser-tuned assures maximum sensitivity and selectivity—features you need for clear, interference free reception in any location.

LARGE PM SPEAKER—A 5-inch Alnico V magnet PM dynamic speaker (not the usual 4-inch speaker used in many small sets) provides excellent tone and plenty of volume. You get the well rounded tonal quality which assures long hours of listening pleasure.

TUNING RANGE—Covers entire broadcast band from 535 kc to 1700 kc. Large Airplane type dial makes it easy to find your favorite station.

TUBES USED: 12SA7GT IF amplifier, Converter; 12SQ7GT Detector and First Audio; 50L6GT Output and 35Z5 Rectifier. Operates on 115 volts, AC or DC.

LICENSED BY R.C.A. and HAZELTINE to bring you the newest developments in radio from these famous laboratories.

Model 1-402. Brown Plastic cabinet is 10 $\frac{1}{2}$ inches wide and 5 $\frac{1}{2}$ inches deep. Shipping weight 10 pounds.

Your Cost, lots of 3, each **\$9.95**
Your Cost, singly **\$10.95**

Model 1-403. Ivory Finish Plastic. Same as above.
Your Cost, lots of 3, each **\$10.95**
Your Cost, singly **\$11.95**

Adapter for operating set from 220 volts AC or DC.
C5243 **\$1.41**



Concord

For Full-Toned Reception

Look at this sensational set. It's really a beauty—a leader in smart appearance and top performance. The beautiful plastic cabinet fits in anywhere—in the living room, in the bedroom, at the office. The amazing power and sensitivity are really worth shouting about. And what tones! An extra large baffle area brings out deep bass and high treble notes like a giant organ. This is your set. It has everything you had hoped to find in a table model radio.

SEMI-CONCEALED HANDLE—Makes this little Concord set the ideal receiver for traveling or moving around the house. When not in use its convenient carrying handle drops down into the cabinet.

SUPERHETERODYNE CIRCUIT—A highly perfected 5-tube (including rectifier) superheterodyne circuit, using multi-purpose tubes. Automatic volume control, usually found only on large console models, reduces fading to a minimum. Condenser tuning permits sharp separation of stations and PLUS performance in the most "out-of-way" locations.

BUILT-IN LOOP ANTENNA—Just plug-in and play almost anywhere. Provision for outside antenna, however, if required in very remote spots. High gain characteristics of loop assure astounding sensitivity.

ALNICO V PM SPEAKER—This Concord Set has a skillfully designed audio system, and a 5-inch PM speaker using the new Alnico V magnet that is many times more sensitive to every impulse than the pre-war type.

SLIDE RULE DIAL—Large, easy to read, easy to tune, slide rule dial makes selecting your programs quick and accurate. Edge lighted, with bold, clear markings.

TUBES USED—Multi-purpose tubes permit greater efficiency from the superhet circuit employed. They are 12SA7GT converter, 12SK7GT IF, 12SQ7GT Detector and 1st audio, 35L6GT output and 35Z5GT rectifier. Operates on 115 volts 60 cycle AC or DC.

Model 1-501. Walnut Plastic. Size: 10 inches wide by 6 $\frac{3}{4}$ inches high by 6 inches deep.
Your Cost, in lots of 3, each **\$15.95**
Your Cost, singly **\$16.95**

Adapter for operating set from 220 volts AC or DC.
C5243 **\$1.41**



Concord

AC-DC Table Model

From its wide, full vision airplane type dial to its gleaming ivory plastic cabinet—here's the perfect receiver for any room in your home. It's packed with exciting new design features, utilizing many new engineering developments. If you want a set that's light and easy to carry from room to room—a set that gives you top performance and glorious tone where ever you use it—then here's your set and no mistake. Buy it on Concord's 30 Day Money Back Guarantee of Satisfaction.

IMPROVED SUPERHETERODYNE CIRCUIT—Different . . . better . . . with many brand-new improvements that help deliver top-quality reception.

ANTENNA—You don't need an outside antenna to bring in nearby and remote stations clear and strong. Provision for outside antenna is included for those who prefer it.

5-INCH ELECTRODYNAMIC SPEAKER—A speaker that gives you plenty of tone . . . a whisper, a high violin note, a low bass, or a whole orchestra, with large console set tone quality.

STREAMLINED AIRPLANE DIAL—Tune in your stations faster, get them clearer with illuminated Dial. No crowding of stations at high frequency end of broadcast band . . . all stations indicated with large numerals, evenly spaced.

WIDE TUNING RANGE. Complete band from 535 KC to 1620 KC.

TUBES USED: 12SK7 IF, 12SA7 Converter, 12SQ7 Det. and 1st Audio, 50L6GT Output and 3Z5GT Rectifier.

Model 1-500—Ivory Plastic with Brown Trim. For 110 volt, AC-DC operation. 12 inches wide, 6 1/4 inches deep, 6 3/4 inches high. Shipping weight 10 pounds.

Your Cost **\$18.95**

C5243—Line Cord Resistor for 220 volt operation.
Additional **\$1.41**



THRILLING FEATURES FOR VALUE-WISE BUYERS

- ★ Modern Plastic Cabinet
- ★ Full Vision Dial
- ★ Glorious Tone
- ★ Powerful Superhet Circuit
- ★ Dual Purpose Tubes
- ★ Amazing Sensitivity

An Outstanding Buy!

AC-DC Superheterodyne

In a Beautiful Wood Cabinet

Only a manufacturing miracle makes it possible for us to give you this sensationally performing table model for so little money. It is possible only because of Concord's tremendous buying power and leadership in the radio field. With its rich, soft finished Walnut veneer cabinet to delight the eye, this amazing set brings you near and distant stations with amazing fidelity and power. It has plenty of big set features, using the newest super-efficient miniature tubes. Truly a once-in-a-life-time value.

535-1720 KC Standard American broadcast and police band.

BUILT-IN ANTENNA: No outside wires. Plug in and play. Connections for outside antenna if desired.

SUPERIOR SENSITIVITY AND SELECTIVITY: New miniature tubes and postwar circuit design bring in weak stations two to four times stronger than formerly.

UNDISTORTED POWER OUTPUT: 1 Watt. Approximately twice that of most comparable tone quality and clarity.

TUBES USED: 12BE6, 12BA6, 12AT6, 50B5 and 35W4. These are all newest miniature type tubes.

ADDITIONAL FEATURES: Automatic Volume Control, Superheterodyne Licensed by RCA laboratories with 6 tuned circuits, Litz wound I.F. Transformers and Oscillator Coil, Power line filter, completely shielded chassis, shock mounted variable condenser. Wide vision slide rule dial for easy station selection.

Model 1-502. Operates on 105-125 volts, 50-60 cycle AC, or 105-125 volts DC. Size 12 1/4 inches by 6 inches by 8 inches. Shipping weight 9 pounds.

List price **\$34.95**

Your Cost each in lots of 3 **\$18.95**

Your Cost each in single lots **\$19.95**

C5243—Adapter for operating set from 220 Volts AC or DC **\$1.41**



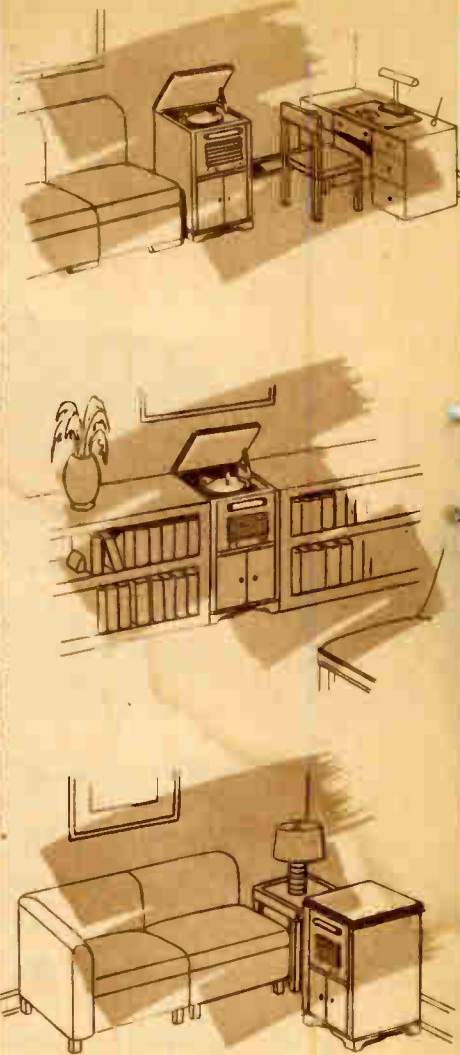

CONCORD *Consolette!*

A Radio—Automatic Phonograph Combination Designed For Modern Living

Perfect for the small home or apartment! Here is complete home enjoyment—Radio and Automatic Phonograph combined—in half the space usually required by a standard Console model. Although it's truly compact in size, this set gives you all the operating convenience and quality construction you've come to expect in radio-phonograph combinations selling at far higher prices. It recreates the artist's original performance in all its concert hall perfection of tone—whether received by radio or reproduced from favorite recordings. The radio is sensitive and amazingly powerful; embodying thrilling new design features to bring you near and distant stations with exciting clarity and volume. Under the handy hinged top is the ruggedly built automatic record player. It changes your records with unbelievable speed—yet it's kind and gentle in action. Just load it up and settle back to listen to a half hour or more of enjoyable recorded music. Plays ten 12-inch or twelve 10-inch records, automatically at one sitting, chosen to delight your mood of the moment.

And look at the cabinet! It's really a beauty—with smart modern styling to add new attractiveness and distinction to your living room or den. Just the right height to blend into sectional furniture or bookcases. In the lower section is a spacious record storage space to hold a large record library—a most desirable convenience feature for small living rooms. Beautifully finished in walnut, heavy rugged construction, built acoustically to eliminate cabinet resonance.

If you're living in crowded quarters—but long for the magnificent tone and wonderful convenience of a large console radio-phonograph—here's your set. A perfect result of the combination of the skill of the cabinet maker and the radio engineer. And here's your set, too, if you're furnishing a den or recreation room where you wish to make the most of every inch of space. It's perfectly designed for modern living.

Sensational Radio Features

- ★ New improved superheterodyne, longer tube life, longer set life.
- ★ Iso-Tron coils—protected from air and moisture. Highly selective IF transformers for top efficiency, sure separation of adjacent stations.
- ★ Automatic Volume Control completely eliminates atmospheric fading and volume rises, maintains listening level set by the manual control.
- ★ Manual volume control separate from On-Off switch.
- ★ High audio output for greater fidelity. Separate tone control.
- ★ New full-vision slide-rule dial. Tuning ratio 4% to 1. Tuning range 540 to 1712 kilocycles (556 to 175 meters).
- ★ Large 6-inch high flux density PM speaker of new acoustic design. Features new Alnico V Permanent Magnet.
- ★ Tubes: 12SA7GT Local Oscillator and Mixer; 12SK7GT IF Amplifier; 12SQ7GT Detector—AVC—First Audio Amplifier; 50L6GT Beam Power Output; new cool, efficient Selenium Disc Rectifier.

Improved Phonograph Features

- ★ Lightning fast record changer. Precision made. Fast, amazingly easy to reload. Smooth, quiet operation.
- ★ Acoustically treated cabinet for improved tone.
- ★ Zephyr weight Crystal pickup. Advanced new type with extended frequency range, assuring remarkable faithful tone fidelity. Equipped with long life floating point needle.

Model No. 1-407 Walnut Finish. Cabinet size is 33½ inches high 20¼ inches wide and 17½ inches deep. Operates on 110 volt, 60 cycle AC only. Shipping weight 67 pounds.

Your Cost \$89.95

Concord

3 Band AC Superhet

Here's a whole world of radio thrills and enjoyment for you! Bring the far away places that you've dreamed about into your home. Paris—London—Shanghai—Moscow—Rio de Janeiro become your next door neighbors with this powerful 3-band AC Superhet circuit. You'll find it has better domestic reception too. This elegant modern plastic cabinet covers a radio that has all the latest discoveries of Concord's radio engineers.

DISTINCTIVE CABINET: Exceptionally large, providing plenty of baffling for superior tone. Styled in smart plastic—in a soft grained Walnut finish.

POWERFUL SUPERHETERODYNE CIRCUIT for clear, perfect reception of most distant stations. Five tubes give seven-tube circuit performance.

5-INCH PERMANENT MAGNET SPEAKER with large Alnico V magnet for superb tonal fidelity. Full 2 watts output.

BROADCAST TUNING from 535 to 1720 kilocycles.

SHORT WAVE BANDS from 2.2 to 7.2 Megacycles and 6.9 to 23.5 Megacycles. Get everything! Domestic, Police, Foreign!

SLIDE RULE DIAL for easy, quick, accurate tuning. No jamming of stations—no double reception at low frequency end of band.

TUBES: 6BE6—Converter, Oscillator; 6BA6—I.F. Amplifier; 6AT6—Det., A.V.C., and Audio Amplifier; 6AQ5—Beam Power output; 6X4—Rectifier. Seven tube efficiency!

FULL RANGE VOLUME CONTROL and Automatic volume control.

Operates on 50-60 cycle 110-230 volt AC only.

Model 1-504. Size: 20 inches wide, 9 $\frac{3}{4}$ inches deep and 15 $\frac{1}{2}$ inches high. Shipping weight 12 lbs.

Your Cost in lots of 3, each **\$32.50**
Your Cost in single lot, each **\$34.95**



Broadcast or Shortwave Reception

Concord

2 Band AC-DC Superhet

Why be satisfied with domestic stations alone—reach out and pull in the principal short wave stations of the world. Hear the news of the world direct from the place it happens, as it happens! It's fun—it's exciting—it keeps you abreast of the times. It's guaranteed to perform to perfection—delivering reception to satisfy the most critical radio expert—bringing in stations with power, clarity, selectivity and fidelity to delight your heart. This superbly built set gives you complete radio entertainment from all over the world.

BEAUTIFUL PLASTIC CABINET. The graceful plastic cabinet has been carefully styled to harmonize with any type of furniture. It is available in Brown or Ivory. The large slide rule type dial assures accurate tuning.

SUPERHET CIRCUIT. Employs dual purpose tubes. Uses 12SQ7GT Detector and First IF; 12SK7GT RF Amplifier and 12SK7GT IF Amplifier; 12SA7GT Oscillator and Mixer, 35L6GT Audio Amplifier and 35Z5 Rectifier.

5-INCH PM DYNAMIC SPEAKER. Has 1.5 watts maximum audio output.

BAND COVERAGE. Broadcast from 540 to 1750 Kilocycles. Short Wave from 6 to 21 Megacycles. Gives band spread tuning ease on short wave band.

BUILT-IN LOOP ANTENNA. High gain type. Operates on 105-125 volts—AC or DC.

Model 1-604. Walnut Plastic. Same as below.
Your Cost each, lots of 3 **\$19.95**
Your Cost each **\$21.50**

Model 1-605—Ivory Plastic. 6 $\frac{1}{2}$ inches wide, 12 inches long and 7 $\frac{3}{4}$ inches high. Shpg. wt. 10 lbs.
Your Cost each, lots of 3 **\$20.95**
Your Cost each **\$22.50**

Adaptor for operating set from 220 volts AC or DC.
C5243 **\$1.41**



TAKE RADIO PLEASURE WITH YOU

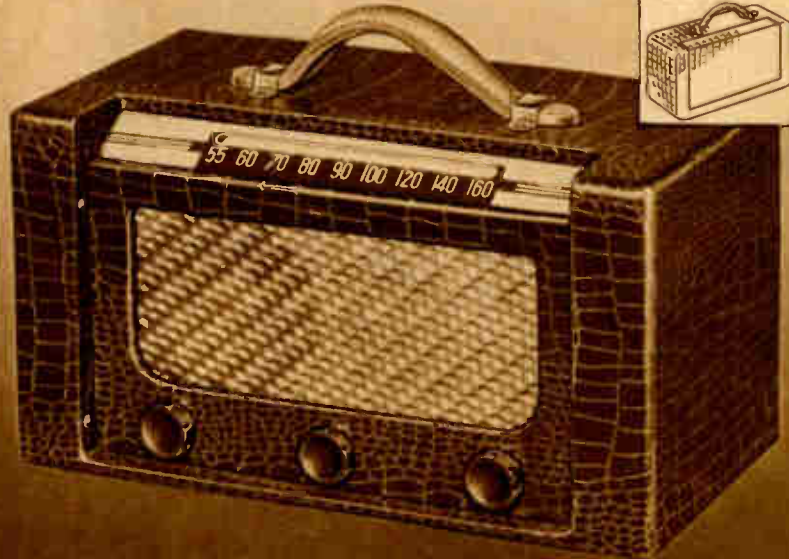
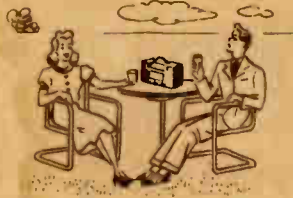

Concord

3 WAY PERSONAL PORTABLE

- ★ Operates on AC or DC or Self-Contained Batteries
- ★ Large Set Tone and Volume
- ★ Economical—Low Battery Drain
- ★ Built-In Loop Antenna

It's small . . . it's light and handy to carry . . . and it's packed with "big set" features and performance you've always wanted in a portable. And look at the price . . . here is truly the most sensational "buy" in a portable we've ever been privileged to offer our customers. Take this compact set anywhere . . . wherever 105 to 120 volts AC or DC house current is available . . . or play it far out in the country from self-contained, long-life batteries. You always get the same super sensitive reception, the same glorious tone quality that makes radio listening truly enjoyable. At your finger tips is a full broadcast band tuning range from 535 to 1720 kilocycles. Hear domestic stations as well as most police calls.

No fuss—no bother. Just open the hinged cover . . . and start listening! No outside aerial to bother with, no batteries to connect . . . just 100% pleasure. The amazing RCA and Hazeltine licensed improved superhet circuit uses the following tubes: 1R5, 1TR, 1S5, 3Q4, and a Selenium Rectifier. 3 of these tubes serve a dual function . . . which means you get extra power, extra efficiency from fewer tubes. This feature cuts battery current drain and gives you real economy of operation. Superhetrodyne circuit and the built-in antenna assure fine reception everywhere. A 3-inch dynamic speaker has an Alnico V magnet. This value-pack portable is housed in a smartly styled, unbreakable plastic case. It requires two 1½ volt "A" cells and one 67½ volt "B" battery. Size: 8½ inches long, 4¾ inches wide and 3¾ inches deep. Shpg. wgt. 7 pounds with batteries.

Model 1-408. Radio without batteries.

Your Cost

\$24.95

Battery Kit for above radio.

Your Cost

\$1.84

Concord

DE LUXE 3-IN-1 RADIO

- ★ Plays Anywhere . . . From Batteries or AC or DC
- ★ Separate Power Tube for Operation on House Current
- ★ Thrilling Performance—Amazing Volume
- ★ 6 Miniature Tubes—Plus Rectifier
- ★ 5-inch PM Dynamic Speaker

What more could you ask in a smart looking, top performing radio . . . at a price that makes it the biggest value of the year! Use it as your main or "extra" set at home . . . take it with you on picnics, to the cabin, on trips! Indoors or outdoors, whether electric current is available or not, here is superb, clear, perfect radio reception equal to that of the finest table models.

From aerial to speaker, it's constructed to an entirely new engineering design to play from either AC or DC or self-enclosed batteries. It's the most complete, most flexible radio you have seen. Although no bigger and no heavier than an ordinary 5-tube portable, this set packs a powerhouse of 6 new type miniature tubes PLUS rectifier in amazing new circuit that delivers exciting performance under any conditions. Here's another "plus" value: A separate power output tube for AC or DC operation. Ordinary sets use the same output tube for both house and battery current. This sensational feature gives you two to four times better weak station reception and five times the speaker volume over conventional portables when run on house current!

Quality features: Three gang condenser, RF stage, power line filter, Litt wound IF coils and powerful 5-inch Alnico V PM speaker. Tubes used: 11726, 3LF4, 1LC6, 1LD5 and two 1LN5. Operates on 105-120 volts DC or 60 cycles AC. Requires 2-4½ volt "A" and 2.45 volt "B" batteries. Sturdy wood cabinet covered with attractive, durable simulated leatherette. Removable hinged cover snaps onto the back out of the way. Strong leather handle makes carrying easy. Here is a portable you'll want to take with you everywhere.

Model 1-607. Radio without batteries.

Your Cost, each, in lots of 3

\$22.95

Your Cost, each, in single lots

\$23.95

Battery Kit for radio above.

Your Cost

\$3.9

EVERYWHERE



Concord MIGHTY MITE Use It Anywhere!

- ★ Weighs Only 8 Pounds
- ★ Full Vision Slide Rule Dial
- ★ Smart Leatherette Covered Case
- ★ Fits on the Palm of Your Hand
- ★ Self-Contained Batteries

Meet the friendliest little radio ever made. It goes along with you wherever you travel . . . to the beach, to parties, to your favorite hide-away . . . or it will stay right at home and entertain you. It's small enough to fit into the palm of your hand . . . but it's really a giant in performance. Its voice is big, with plenty of volume. And it's really smart looking too, in its trim, durable leatherette covered case with contrasting plastic carrying handle.

Maybe you never thought much about the "insides" of your radio. But it's good to know this powerful Mighty Mite is ruggedly constructed to give you long, satisfying performance. It's made of the finest components, including the newest miniature tubes that proved so sensational during the war for walkie-talkies and other battle equipment. The skillful design by expert engineers assures you top performance from every part and tube.

Operates from self-contained batteries. Equipped with a built-in antenna and two midget IF stages. Uses the following miniature tubes: 1S5, 3Q4, 1T4 and 1R5. Has a 3 1/2-inch speaker. Easily fits on the palm of your hand for it's only 7 inches long, 6 1/4 inches high and 3 3/4 inches wide. Here is a portable radio with advanced design at an economical price!

Model 1-400. Portable Radio less batteries. Shipping weight 8 pounds.
Your Cost, each, in lots of 3 **\$15.95**
Your Cost, each, in single lots \$16.50
 Battery Kit for Portable Radio above.
Your Cost **\$1.85**

CONCORD FARM RADIO



Designed for the Country Home BATTERY OPERATED TABLE MODEL RADIO

- ★ Low Cost Battery Operation
- ★ Improved Superhet Circuit for Brilliant Tone
- ★ Built-In Loop Antenna for Long Range Reception
- ★ Low Current Drain Battery Tubes for Economy
- ★ Full Vision Airplane Dial for Easy Tuning
- ★ 5-Inch PM Dynamic Speaker for Wide Range Clarity

At last . . . a powerful battery operated superhetrodyne receiver, designed expressly for the Farm or Country Home. It has all the clarity and volume, all the smart appearance of the city AC or DC operated cousin. Everything is self contained—no external batteries or outside aerial to worry about. And what reception! Even if you're located many miles from the nearest broadcast station, signals roll in like magic. This amazing performance is possible only because Concord Farm Radio uses the newest, most efficient dual and triple purpose tubes in an improved, super-sensitive superhet circuit. You'll be thrilled and delighted with the full, rich tone quality. This set features a large 5-inch PM dynamic speaker with efficient Alnico No. 5 magnet. It handles tremendous volume with true wide range tone.

A large, full vision airplane dial tunes the entire broadcast band—from 535 to 1720 kilocycles. Covers all domestic stations and many police calls. Automatic volume control and full range manual volume control eliminate blasting and fading . . . always keeps your station at a constant volume level.

Here's a battery operated radio that promises—and delivers—real economy of operation. Low drain battery tubes, combined with top circuit efficiency, assure you long battery life. Operates on any battery pack supplying 1 1/2 volts "A" and 90 volts "B." Uses 1H5 Diode, Audio and AVC, 3Q5 Power amplifier; 1A7 First Detector and Converter; 1N55 IF amplifier.

Model 1-405. Brown Cabinet. Size: 10 1/2" x 4 3/8" x 6 1/8" Shpg. wgt. 7 lbs. **\$19.95**
Your Cost, each, in lots of 3 \$20.95
Your Cost, in single lots \$22.50
Model 1-404. Same as above except Ivory Cabinet. **\$20.95**
Your Cost, each, in lots of 3 \$22.50
Your Cost, in single lots \$23.35
 Battery Pack for above.
Your Cost \$3.35

Concord

Radio-Phonograph Combination

With Automatic Changer

Enjoy complete home entertainment. From records! From radio! And all at a price you can really afford. This beautifully styled Concord Radio-Phonograph Combination plays records automatically—and at the flip of a switch brings you the finest in radio enjoyment with supreme clarity and tone quality. Its thrifty price will appeal to the budget minded—it's distinctive cabinet and glorious performance will appeal to those who could pay much more.

THE CABINET: Attractively styled to harmonize with any surroundings. Beautifully fashioned of fine Walnut veneers. The top has been hand rubbed to bring out the beauty of the gorgeous grain. The heavy, warp-proof lid conceals the changer and eliminates needle noise. The radio tuning dial and controls are easily accessible without raising the lid. This sturdily constructed cabinet will fit the top of any standard record storage cabinet.

THE RADIO: A powerful superheterodyne with fine quality audio system for superb reproduction of both radio and records. Large 5-inch PM dynamic speaker. Has built-in loop antenna and full range tone control. Uses two dual purpose tubes for top seven tube efficiency; 12SQ7GT Detector and first IF, 12SK7GT IF, 12SA7GT Oscillator and mixer, 50L6GT output and 35Z5 Rectifier.

THE PHONOGRAPH: So easy to operate that even a child can use it. Separate "Off"—"On"—"Reject" buttons make it completely fool-proof. The automatic changer holds 12 ten-inch or 10 twelve-inch records. You can hear your favorite symphony or enjoy piece after piece by your favorite artist without changing a record. The lightweight crystal pickup has the new "Floating Point" needle. You'll find this fine phonograph is the perfect companion to the top quality radio.

Model 1-505. Operates on 105-125 volts, 60 cycle, AC only. Cabinet size is 20 inches wide, 15 inches deep, and 9 inches high. Shipping weight 35 pounds

Your Cost, each, in lots of 3 **\$47.50**
Each in single lots **\$49.50**



An Exceptional Value!

Portable Phono-Radio

With Automatic Changer

What an opportunity to SAVE! Thousands of satisfied users paid the nationally advertised price of \$94.50 for this superb Phono-Combination. Now it's yours for only \$47.50! Hear it! Enjoy its full, rich tone and record breaking performance. Then you'll be convinced it simply can't be surpassed for quality construction, sensational radio reception and record reproduction PLUS really good looks.

THE RADIO: 5 tubes plus Selenium Rectifier, gives 6-tube performance on 540-1700 KC Standard American Broadcast and Police Bands. Illuminated slide-rule dial. Higher undistorted output due to Selenium Rectifier, over 1½ watts—approximately twice that of most other comparable sets. Continuously variable tone control gives deep throated to clear toned treble reception. Inverse feedback reduces distortion and hum. Fine speaker with Alnico V Permanent Magnet. Built-in antenna—no outside wires, connections for outside aerial if desired. Automatic Volume Control. Power line filter, completely shielded chassis, shock mounted variable condenser, Hi-Cap Filter Condensers. Uses 12SA7, two 12SK7, 12SQ7, 50L6 and Selenium Rectifier.

THE PHONOGRAPH: Simple and foolproof, quick and smooth record changer of latest design to play ten 12-inch records or twelve 10-inch records automatically with lid closed. Lightweight crystal pickup with new Floating Point needle. Quiet self-starting motor. Featherweight pressure tone arm. Tone arm firmly anchored when not in use.

THE CABINET: A wonder for beauty and downright convenience, this phono-radio will grace the finest living room, den or playroom. Its ruggedness and light weight make it ideal as a portable for school, college, parties or picnics. All exposed surfaces finished in waterproof plastic treated leatherette.

Model 1-506. Size 20¾ inches by 15½ inches by 8¾ inches. Shipping weight 36 pounds. Operates on 105-125 volts, 60 cycle AC. List Price \$94.50

Your Cost, each, in lots of 3 **\$47.50**
Each in single lots **\$49.50**



PORTABLE RECORD PLAYER

- ★ 3-Tube Amplifier
- ★ Special Tone Control

This portable electric phonograph will surprise and delight you with its excellent construction and superior performance. It plays your favorite recordings with amazing power and fidelity. You can play it in any room in the house or take it over to your friends. All you have to do is plug it into a wall socket and it's ready to go. Plays any standard 10-inch and 12-inch shellac, acetate or paper base recording or transcription—and with a tone quality and volume comparable to much higher priced portables.

High fidelity three-tube amplifier provides ample volume for even crowded rooms and loud parties. There's no need to readjust the volume for every record as a separate "On"-"Off" switch allows you to change the records without changing the volume. Individual tone control makes it easy to adjust treble or bass to just the right pitch. The cover can be closed while playing to eliminate needle noise. The sturdily constructed cabinet is covered with pebble finished leatherette and has a strong plastic handle for easy carrying. Self-locking hinges hold lid open when changing records. Light-weight crystal pickup reduces record wear and improves tone. Improved PM speaker with efficient Alnico V magnet handles maximum volume without distortion. Operates on 110 volts, 60 cycle, AC only. Size: 15 inches by 15 inches by 8½ inches. Model C22653. Shipping weight 15 pounds.

Your Cost, lots of 3, each..... **\$22.95**
Your Cost, singly..... **\$23.95**



PORTABLE RECORD PLAYER

With Automatic Changer

- ★ Gentle on Records
- ★ Play Ten 12" or Twelve 10" Records

Here's what you've been waiting for! A new portable phonograph equipped with an automatic record changer. It's complete all by itself. All you have to do is plug it into a socket and listen to it play one record after another. For real listening pleasure—or for parties and dancing—this portable record player gives you music wherever you want it. The new design amplifier has full, rich tone with plenty of bass. Shaped like a suitcase, it's easy to carry too. It's modernly designed to make the best possible use of every inch of its 19-inch length, 14-inch width and 7½-inch height. Plays and changes AUTOMATICALLY 10 twelve-inch or 12 ten-inch records at one sitting.

Changer is ruggedly built and trouble-free. It's noiseless and it's fast... only 5 seconds between records! Gentle action increases record life, decreases breakage. Easy to load it lets you enjoy almost three quarters of an hour of uninterrupted entertainment. Lightweight crystal pickup with replaceable needle. Boasting many fine features usually found only in much costlier players, this portable phonograph delivers the maximum in convenience and pleasure. Uses 12SL7CT, 35L6 and 35Z5 tubes. Sturdy case covered in attractive pebble finished leatherette. Self-locking hinges hold lid open when changing records. Operates on 110 volts, 60 cycle, AC only. Shipping weight 20 pounds.

C22652. Your Cost, lots of 3, each..... **\$33.95**
Your Cost, singly..... **\$34.95**



WIRELESS RECORD PLAYER

With Automatic Changer

- ★ Play Through Any Radio
- ★ No Connecting Wires Required

No connecting wires... yet you reproduce automatically through any radio within 75 feet! You can put a stack of 10 twelve-inch records or 12 ten-inch records on the turntable and hear them reproduced through any radio in the house—even your car radio if it is within range. Volume and quality of reproduction is controlled by your home radio you have tuned to the wireless player. Uses quiet trouble-proof automatic record changer with lightweight crystal pickup. Quickly adjusted for 10-inch or 12-inch records with on-off reject switch conveniently located. Size 12½ inches by 11 inches by 8½ inches. Shipping weight 18 pounds.

C22651. Wireless record changer for 105-125 volt, 60 cycle, AC only. **\$28.95**

Your Cost.....
C22656. Same as above except is a wired model. Plugs into standard phonograph jack. Operates on 105-125 volt, 60 cycle, AC only. Shipping weight 16 pounds. **\$23.95**
Your Cost.....



PORTABLE ACOUSTIC PHONOGRAPHS

Hand Wound—Does Not Need Electric Current

Here is the portable phonograph you've always wished for—one you can play anywhere. Spring wound, it's perfect for picnics, summer homes, play rooms, etc. This new acoustic phonograph plays both 10-inch and 12-inch records with remarkable tone quality. The sturdily built wood case is lightweight, easy to carry or pack with luggage. It is covered with extra heavy duty leatherette and has a leather carrying handle. Strong hinge holds top open when records are being played. Lid has special compartment for carrying records. Needle holder has spring type cover. A special control allows you to regulate the speed of the turntable. Winding handle of spring wound model is detachable and fits in a special carrying slot inside when not in use. Motor is precision made with "On"-"Off" switch for turntable. Strong snap type locks hold lid securely closed when not in use. Your choice of either spring wound or electric model.

C22657. Spring wound motor. Shipping weight 14 pounds. **\$16.95**

Your Cost.....
C22658. Electric motor. Operates on 110 volts; 60 cycle, AC only. Shpg. wt. 14 lbs **\$16.95**
Your Cost.....



Wire Recorders • THRIFTY-PORTABLE • EASY TO USE •



RCA Wire Recorder

Anyone, without previous recording experience, can make accurate, fine quality recordings. Merely plug cartridge in, turn on power and record or play! Cartridge contains simple mechanism driving two recording wires. No threading is required and it is not necessary to handle the wire. Recordings may be erased at your discretion and cartridge used for new recordings an indefinite number of times. Absolutely fool-proof! Timing dial built into cartridge is calibrated in minutes running time for both wires. Notations of recording sequence can be made for future reference.

LIGHTWEIGHT-PORTABLE—Carry it from room to room, office to office, or take it with you on your business trips. Weighs but 24 1/2 pounds. A built-in retracting handle permits carrying the instrument with ease.

SIMPLE PLUG IN CONNECTIONS—Microphone and Power cord connections are simple plug-in type, instantly attached or removed from terminal board at the rear of recorder. Terminals provided for connecting an external speaker. Records the speaking or singing voice, or instrumental music. Ideally suited for:

SCHOOLS—Educational institutions of all types will find numerous uses in music departments, speech groups and foreign language classes.

BUSINESS MEN—Executives will find this instrument a "third hand" in the recording of timely notes, interviews and conferences.

PUBLIC SPEAKERS—Public speakers, actors, clergymen and dramatists can not find anywhere a more useful assistant in their daily work. Improvement of diction, enunciation, and delivery is assured through self-study.

MUSICIANS—For artists in all phases of musical endeavor, the wire recorder is invaluable for perfecting technique, studying performance, and rendition. Black Plastic and Chrome Case measures 9 3/4 inches wide, 12 1/2 inches deep, and 9 3/4 inches high. Complete with one 30-minute wire cartridge, dynamic microphone on 6-inch desk stand, microphone cable, power cord and plug.

Cat. No. C22539. Shipping weight 28 pounds. **\$130.00**

Your Cost
Cat. No. 16309. Wire Cartridges—30-minute recording time. Each . . . \$14.70



WEBSTER Wire Recorder

Webster Model 80. Completely portable all-purpose recorder and playback unit using "Magnetic Wire Recording" principle. No needles to change, no blanks to watch—just flip a switch and start recording. So simple a child can record with perfect results. Grownups appreciate absence of complicated switches and involved operating procedures.

For dictation in business offices, machine will do work of several cylinder-type recorders because of ease of erasing. Automatic erase operates at touch of switch. Its lightweight and ability to record continuously for one hour makes unit ideal for on-the-spot news coverage, interviews, wherever a portable recorder or long continuous recordings are required.

Magnetic wire recordings are permanent and can be replayed thousands of times. A single word or a whole program can be easily erased. Wide range volume and tone controls for recording and playback. Built-in 6-inch speaker and 3-tube amplifier for quality, self-contained playback. External speaker can be plugged into front panel. To amplify output for public address or other purposes an external amplifier and speaker can be connected.

Housed in attractive case, which when closed resembles an expensive leather covered overnight bag. Complete, ready to record, includes: Recording Mechanism Microphone, Amplifier, Speaker and Three Spools of Recording Wire (two 15 min. and one 30 min.). Measures: 17 1/2" x 11 1/2" x 7 1/2" with case closed.

Cat. No. C22508. Shipping weight 32 pounds. **\$149.50**

Your Cost
C22507. Wire Recording Mechanism only, for building your own portable recorder or for permanent installations . . . \$52.92
C16300. Extra 15-min. spool . . . 2.35
C16301. Extra 30 min. spool . . . 3.53
C16302. Extra 60 min. spool . . . 6.32
C16303. 10-ft. input cord assembly for connecting to radio . . . 1.75
C16304. 10-ft. output cord assembly for external speaker or amplifier . . . 1.75

MEISSNER Recorder-Phono-Radio and Amplifier System



It's easy to make fine recordings with this high quality unit! A high fidelity crystal cutting head assures faithful recording of program material and an excellent crystal microphone is furnished for natural sounding, lifelike recording. Normal and overload indicators simplify control of input levels and permit anyone to cut perfect discs. Easy to follow directions are given in the instruction manual.

Radio broadcasts recorded by simply switching radio to one of the recording channels. Separate volume controls for the microphone and radio input channels to the recorder allow programs to be mixed and blended with recording studio technique. Two turntable speeds, 78 and 33 1/3 rpm, provide for up to 10-inch disc recording and 12-inch playback, with full control of tone and volume. Superheterodyne receiver designed for reception over the entire broadcast band with excellent sensitivity and selectivity. Amplifier serves as announcer or public address system. With the microphone provided, the set is always ready for use before small gatherings. Provision made for connecting extra speaker where greater volume is required.

Everything you need is furnished with Radio-Phono-Recorder. Built-in radio and amplifier are equipped with full set of seven tubes; crystal "hand or stand" microphone and its cable are in storage compartment ready for connection. Complete unit, with cover is only 19 1/2 inches square, 9 1/4 inches high. Sturdy wooden case, with heavy airplane luggage finish is durable and attractively modern. Storage compartment for records in removable lid. Take the Radio-Phono-Recorder-Amplifier System with you wherever you go. Just plug into any 115-volt, 60-cycle source.

Cat. No. C22580. Shipping weight 52 pounds. **\$111.28**

Your Cost

REASONS WHY YOUR BEST BET FOR AMPLIFIERS IS CONCORD

A Complete Line to Choose From

Your best bet for amplifiers is CONCORD because you have a complete line to choose from. Whether you need high power or low power, a portable or permanent system, a single record player or automatic changer you will find the one to fill your needs. And all at prices far below what you would expect to pay for top quality equipment.

You Get Everything You Need — Ready to Operate

Your best bet for amplifiers is CONCORD because all Concord amplifiers and systems come complete and ready to operate. You get everything you need including cables, connectors and plugs. All you have to do is set it up and plug into the electric outlet.

Free Technical Service to Help You

Your best bet for amplifiers is CONCORD because at Concord an expert staff of engineers skilled by years of experience in all phases of radio, electronics and public address systems stand ready to assist you free of charge. No problem is too big or too small. All you have to do is write and ask, it's absolutely FREE!

27 Years of Dependable Service

Your best bet for amplifiers is CONCORD because you are dealing with a company that has been in the radio and sound business for over 27 years. You can buy with utmost confidence of receiving dependable service, fine performance and true reproduction. For you are buying a product of proven quality—proven by years of use.

You Can Pay for It While You Use It

Your best bet for amplifiers is CONCORD because it's thrifty and easy to buy them on Concord's Time Payment Plan that lets you pay for the amplifier while you are using it. Yes, your credit is good at Concord. It's simple, it's easy—you can buy all of the wonderful new equipment you want with only a small down payment and take a year to pay the balance.

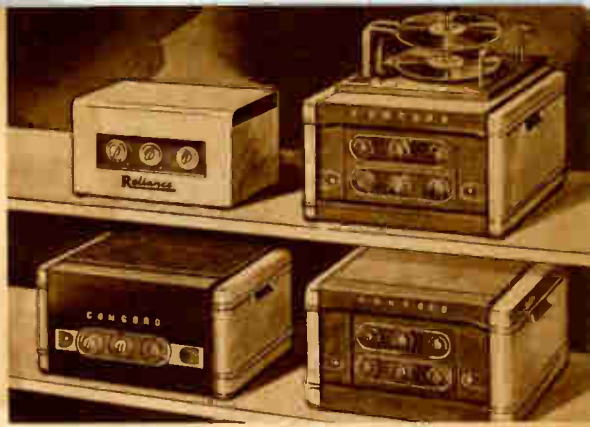

A Complete Line of Amplifiers
To Choose From



Complete—Ready To Operate—
Just Set It Up



Free Technical Advisory
Service To Help You



Time Payment Plan Lets You
Use It While You Pay



Backed By 27 Years Of
Experience

HOW TO SELECT THE CORRECT SOUND EQUIPMENT



WHAT POWER? 15 WATT? 30 WATT?
 MICROPHONE LOCATION?
 PORTABLE OR PERMANENT SYSTEM?
 PHONOGRAPH OR AUTOMATIC CHANGER?
 SPEAKER LOCATION?
 WHAT SPECIAL PROBLEMS?

15? 30? 45?
WATTS
 60? 75? 90?

Have Enough Power To Do The Job

The following information will serve as a guide in choosing the size (wattage) of amplifier required for various installations. Determine the seating capacity or room volume in cubic feet for indoor systems or the area in square feet for outdoor systems, refer to the chart below and the last section will indicate the recommended wattage of the amplifier to use. The first column of the last section is the required wattage for installations with low noise levels, such as funeral homes, hospitals, quiet offices and warehouses. The second wattage column, where normal room noise is encountered, as in small restaurants, large offices, residential areas, light or medium manufacturing. The last column is for locations with very high noise levels such as heavy manufacturing, including boiler factories, pneumatic riveters, steel mills, large stadiums and outdoor street advertising or announcing.

Seating Capacity	Area Coverage		Required Watts		
	Indoors	Outdoors	Quiet	Normal	Noisy
750	280,000 cu.ft.	15,000 sq.ft.	7.5	11.25	15
1500	600,000 cu.ft.	30,000 sq.ft.	15	22.5	30
3000	1,200,000 cu.ft.	60,000 sq.ft.	30	45	60
4500	1,800,000 cu.ft.	90,000 sq.ft.	45	67.5	90
6000	2,400,000 cu.ft.	120,000 sq.ft.	60	90	120
7500	3,000,000 cu.ft.	150,000 sq.ft.	75	112.5	150
9000	3,600,000 cu.ft.	180,000 sq.ft.	90	135	180



Use The Right Microphone In The Right Place

Fidelity is the accuracy with which a microphone reproduces sound. The wider the range, the more normal will be the sound from the speakers. In general, where conditions of feedback are likely to be encountered, a uni-directional type of microphone is best. Bi-directional, or velocity, types are recommended for studio and recording purposes but not for outdoor work, as serious distortion is introduced by the effects of wind. Crystal microphones are considered good all around instruments except where temperatures of 120 degrees or more are encountered. Dynamic types are more rugged and can be used indoors or outdoors, but are generally more expensive than crystal microphones. For complete information on uni-directional, bi-directional and semi-directional microphones see the microphone section in the following pages.

It is always advisable to locate the microphone of a sound system in such a position that the least amount of sound from the loud speakers will re-enter the mike. Wherever possible, operate the microphone as close as possible to the amplifier or try to keep the length of the microphone cable as short as possible.

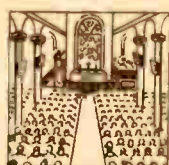

Select And Locate Speakers Carefully

When selecting a speaker or speakers, it is advisable to have the total wattage ratings of the speakers equal to or greater than the wattage output of the amplifier you have selected. If intended to use a 30-watt amplifier, a 10-watt speaker can be used by itself, but it would not be capable of handling the full output of the amplifier. Therefore more 10-watt speakers would be recommended, or if one speaker only is to be used, we would recommend one with a 30-watt rating. All speakers shown on our speaker pages have a power handling rating indicated in watts. All speakers should operate in some kind of enclosure, to protect the speaker and act as a sounding board. Several types of enclosures or baffles are available and fully described on the page listing baffles. Speakers should be mounted in such a manner that they will reproduce the sound to the desired location only. Remember sound can be distributed by wire more easily than by air. Consequently an announcement or call made into a microphone at a location such as a telephone switchboard can be conveyed to various selected locations in a large building by merely placing the speaker in the proper area. It is recommended to use more speakers in order to distribute sound properly and tend to saturate the area with sound rather than have it blast from one speaker and create unnatural effects. For instance, in a large church with a high dome and ceiling and hard walls, one or two speakers would cause the sound to reflect from the walls in all directions and possibly create an echo effect as well as distortion. By using two or more speakers on each side of the church walls and not too high from the floor, a soft mellow effect would result with the sound properly distributed only where it is required, that is, in the seating area and not at the dome or ceiling.

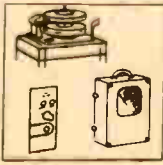

Choose Accessories To Fill All Your Needs

After selecting an amplifier with the proper wattage and determining the number and location of speakers and microphones, decide whether a phonograph will be required and if an output indicator is necessary. The Concord Multiamp Amplifier is available with a built-in output level indicator and can also be equipped with a single record phono top or an automatic record changer, giving you all the features you need in one unit! Regardless of whether you need a portable or permanent system, a large or small unit, you can find the correct sound equipment to fill your needs in the following pages. If you have a special P.A. problem consult Concord's free Technical Advisory Service for the help of expert sound engineers.

PORTABLE SYSTEM

- ★ Ideal for pitchmen, store demonstrations and lecturers
- ★ Compactly designed, lightweight—it's really portable
- ★ Conservatively rated at 7 watts output
- ★ Covers audiences up to 700 people

Here is an amplifying system that has been especially designed to fill the needs of store demonstrators, pitchmen and others who want small audience coverage. Here is a low power amplifier with the dependability and fine performance of a large unit.

Separate Inputs For Microphone and Phonograph. Fader control for microphone—phonograph controls volume and lets you change from one to the other smoothly, easily, as you desire. Almost any external type phonograph can be used.

Compact Design Makes Carrying Easy. Lightweight with everything in one case it's really portable. The 8-inch PM speaker is mounted in a strong, leatherette covered, wooden case. This case also holds the amplifier and the microphone. Four strong snap locks hold the lid securely closed when being carried.

The 7 Watt Amplifier has a recessed, indirectly illuminated front panel and is mounted in an attractively styled cabinet. Output transformer is mounted in the amplifier so that a second speaker can easily be added. Tubes consist of 1-6SL7, 1-6L6 and 1-5Y3. Extremely low hum level—60 db below rated output, 102 db gain on microphone channel, 70 db gain on phono channel, output impedance taps at 4 and 8 ohms. Has one fader volume control, one tone control and rotary "On"."Off" switch. Steel cabinet has a burgundy wrinkle finish and is open at the back for easy access to chassis.

Cat. No. 2-100. 7 watt Reliance Amplifier complete with tubes, instructions and all necessary connecting plugs. Sh. wt. 18 lbs. **\$21.75**
Your Cost

Cat. No. 2-101. 7 watt Reliance Portable Amplifier System shown at the right. You get everything you need ready to operate. All you have to do is set it up. System consists of 7 watt Reliance Amplifier complete with tubes, all necessary connecting plugs, Shure model 718A Versatex microphone with cable, 8-inch P.M. speaker with 35-feet of cable mounted in a portable case that also holds the amplifier. Shipping weight 42 pounds. **\$38.75**
Your Cost

PERMANENT SYSTEM

- ★ Ideal for clubs, recitals, and small groups
- ★ Output transformer is mounted in the amplifier
- ★ Separate inputs for microphone and phonograph
- ★ You get everything you need—a complete system

For all around dependability and superb performance here is a truly remarkable value in a low power amplifier. Its 7 watts output covers audiences up to 700 people making it an ideal system for clubs, restaurants, small halls, music recitals, call systems, schools, offices or anywhere that a limited area is to be served. Compactly designed, it is built of the finest materials and components and expertly engineered to the highest standards of performance.

A Complete System. You get everything you need including amplifier, speaker, wall baffle and microphone, speaker cable and microphone cable. All you have to do is set it up.

The Amplifier. The 7 watt amplifier is the same fine quality Reliance amplifier described in the portable system above. The tone control has broad variation to suit your preference or the acoustics of the place where the amplifier is to be used. With the output transformer mounted in the amplifier a second speaker can easily be added. Overall frequency response is from 70 to 10,000 c.p.s.

The Speaker. The speaker is a Concord PM 8-inch with extremely fine frequency response. It has 35 feet of speaker cable.

The Wall Baffle. The fabricoid wall baffle is designed to accommodate the 8-inch speaker. It is sturdily built and correctly angled to provide coverage over a wide area.

The Microphone. Shure Model 718A Versatex complete with 7 feet of cable. Has an RF filter.

Cat. No. 2-102. 7 watt Reliance Deluxe Permanent System shown at the right. All you have to do is set it up. You get everything you need ready to operate. System consists of 7 watt Reliance Amplifier complete with tubes and all necessary connecting plugs, Shure model 718A Versatex microphone with cable, fabricoid covered wall baffle and 8-inch P.M. dynamic speaker with 35 feet of cable. Shpg. wgt. 32 lbs. **\$32.80**
Your Cost

Cat. No. 2-103. Same as 2-102 above except with 2 8-inch speakers, 70 feet of cable and 2 wall baffles. Sh. wt. 42 lbs. **\$38.95**
Your Cost

Cat. No. 22047. Microphone Floor Stand. (Shown on page 22.) A top quality, chrome-plated, telescopic stand for use with either of the systems above. Height is adjustable from 35 inches to 68 inches. Shipping weight 19 pounds. **\$4.69**
Your Cost

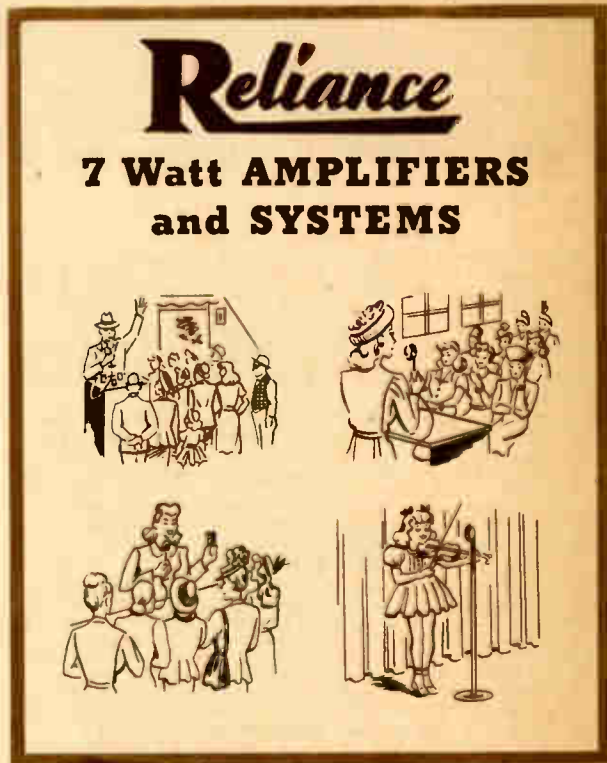
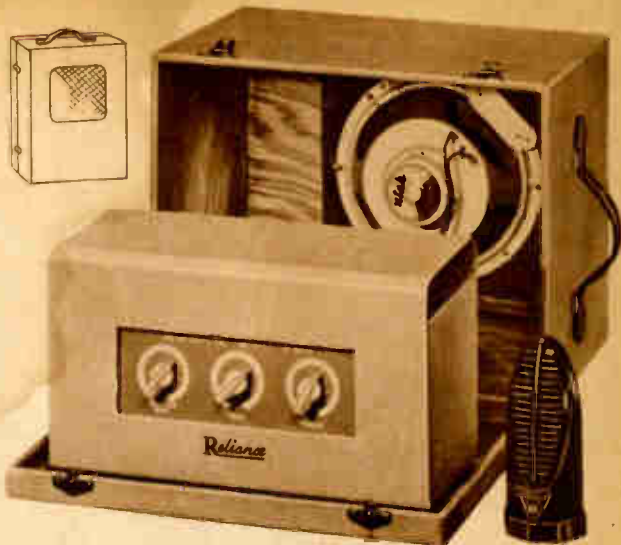

15 AND 30 WATT CONCORD DELUXE

Compare
These Features
With Any Other
**15 Watt
Amplifier**

- ★ 7 Tubes
- ★ 15 Output Impedances
- ★ 2% Distortion
- ★ 2 Dual Purpose Inputs



Flexibility of Input and Output

Two dual purpose input channels are provided, each of which has two input jacks, one for microphone and another for phono player inputs. Thus the amplifier can operate with 2 mikes or 2 phono inputs simultaneously, or 1 phono and 1 microphone. Microphone and phono inputs may be mixed with the smoothness of broadcast studio equipment. The microphone input gain of 110 db. is more than enough to match any high quality microphone or other input device. Power output is conservatively rated at 15 watts output. It has only 2% distortion at normal rated output and at peak power.

Fifteen output impedances are provided in order than an exact impedance match may be effected with any output device or line; thereby affording greater efficiency and consequently requiring less power to cover a given area. An imprinted chart is permanently screened on the bottom cover plate listing impedances (see "SPECIFICATIONS"). Bass-Treble type tone control is provided, affording a tonal range from a deep mellow bass to a crisp high treble. This well tapered tone control will make possible the compensation of acoustical differences.

Advanced Circuit Design

High gain tubes and parts are mounted on shock absorbing mounts to prevent microphonic noises that frequently occur with amplifiers when rubber shock mounting is not used. Input stages are coupled to the output stage by the transformer method which provides better overload performance. The 15 watt output stage employs the patented beam focusing circuit which affords great efficiency of power conversion. The resulting high quality output of this amplifier is truly remarkable and is to be equalled only in higher power amplifiers at far greater cost.

Streamline Design Cabinet

Cabinets are constructed of sheet steel and cast aluminum for lighter weight and better heat dissipation. Handles are cast into the cast aluminum sides, thereby eliminating the old style protruding handles which are ugly and add to the overall size. Cabinets are finished in two-toned burgundy enamel and wrinkle with polished aluminum borders for decorative effects. Knobs are of a contrasting ivory tone. Amplifier top is arranged to allow for maximum ventilation.

Phonograph Top Available. The top panel of both the 15 and 30 watt models can be removed and replaced by a new panel housing the phono motor. This panel is drilled beneath the phono turntable in order to provide adequate ventilation for the motor and the amplifier. All connections come from a panel on the back for protection against damage.

Available in Permanent and Portable Systems. You can buy either the 15 or 30 watt amplifier only, or, you can get either one in a complete portable or permanent system that's ready to operate.

30 Watt Concord Deluxe Amplifier

Designed to cover indoor audiences up to 3000 people and outdoor areas up to 60,000 sq. ft. it's an ideal unit for ballrooms, railroad terminals, churches and theatres. It has the same universal type inputs, focused beam circuit, modern cabinet and other features of the 15 Watt Concord Deluxe described at the left except for power, impedance taps and some other specifications shown below.

Specifications of 30 Watt Concord Deluxe Amplifier

30 watts, 70 volts Normal Power Output. 5% Distortion. 40 watts Peak Power Output. 2 Microphone Inputs. 2 Phono Inputs 60 db Phono Gain. 105 db Microphone Gain. -55 db Hum Level. 50-10000 c.p.s. Frequency Response. Bass-Treble Tone Control. Two gain controls with phono and microphone input on each. 4, 8, 166 ohms output impedances. Operates on 110 watts at 117 volts, AC, 60 cycle. Tubes: 2—7B4, 1—7F7, 4—6V6 and 2—6X5. Size: 15" by 10" by 8 1/4". With phono: 15" x 10" x 10 1/4".

Accessories for Concord Deluxe Amplifiers

Cat. No. 2-107. Accessory Phonograph Top for Concord Deluxe Amplifiers (see D on opposite page). Shipping weight 9 pounds. **Your Cost, \$11.50**

Cat. No. 20077. Deluxe All-Steel Projector (see B on opposite page) for 12-inch speaker. Can be used with any Permanent System. Shipping weight 13 pounds. **Your Cost, each, \$10.53**

Cat. No. 20056. 12-inch Leatherette Covered Wood Wall Baffles (see C on opposite page). Can be used with any of Permanent Systems. Shipping weight 6 pounds each. **Your Cost, each, \$4.10**

SPECIFICATIONS

15 Watt Concord Deluxe Amplifier

Normal Power Output 15 watts; Peak Power 30 watts

Distortion 2% at 15 watts

Microphone Channels—2 each at 110 db.

Phono Channels—2 each at 70 db.

Bass-Treble Tone Control.

Hum Level 55 db. below full signal

Frequency Response 50 to 10000 c.p.s.

15 Output Impedances: 1.3 2.7, 4, 5.3, 8, 16,

125, 167, 180, 200, 250, 415, 460, 500, and

600 ohms.

A.C. Line Power Requirements: 117 volts, 60

cycles, 70 watts; with phono 84 watts.

Tube Line up: 4—6SJ7, 2—6V6 GT, 1—6X5.

Dimensions: 15" by 10" by 8 1/4".

With Phono: 15" by 10" by 10 1/4".

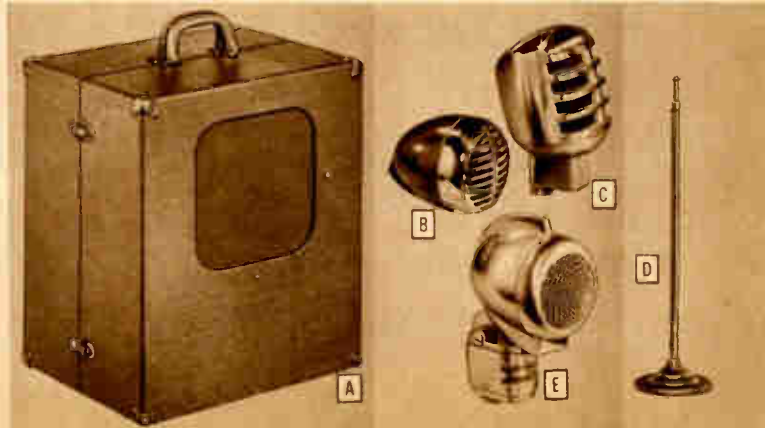

AMPLIFIERS AND SYSTEMS

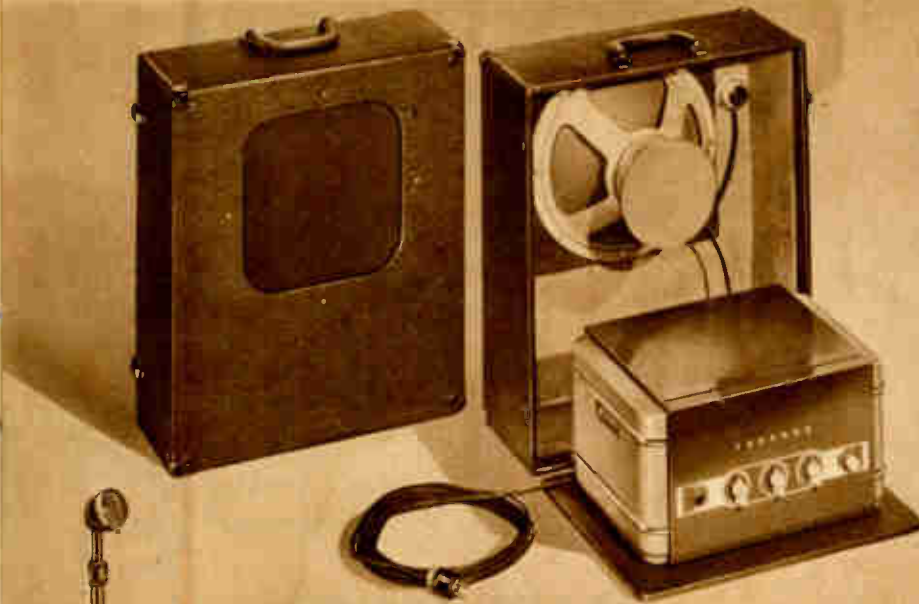

You Get A
Complete System
 Ready to Operate

- ★ Amplifier
- ★ Speakers and Cables
- ★ Microphone and Cable
- ★ Floor Stand
- ★ Carrying Case

15 Watt Concord Deluxe Amplifiers and Systems

Cat. No. 2-105. 15 Watt Concord Deluxe Amplifier (shown on page at left) with tubes, instructions and necessary connecting plugs. Shipping weight 22 pounds. **Your Cost \$37.50**

Cat. No. 2-108. 15 Watt Concord Deluxe Portable System (shown above). You get everything you need ready to operate! All you have to do is set it up. System consists of 15 Watt Concord Deluxe Amplifier, two 12-inch Alnico V G.E. PM speakers with 70 feet of cable and mounted in carrying cases that also hold the amplifiers. Shure model 707A20 microphone (see B on opposite page) with 20 feet of cable and a floor stand. Shipping weight 70 lbs. **Your Cost \$78.50**

Cat. No. 2-109. Same as 2-108 above except with a Turner model 22X microphone (see E on opposite page) with 20 feet of cable instead of the Shure model 707A20. Sh. wt. 70 lbs. **Your Cost \$81.65**

Cat. No. 2-110. Same as 2-108 above except with a Electrovoice model 610-20 microphone (see C on opposite page) with 20 feet of cable, instead of the Shure model 707A20. Sh. wt. 70 lbs. **Your Cost \$84.65**

with 20 feet of cable, instead of the Shure model 707A20. Sh. wt. 70 lbs. **Your Cost \$84.65**

Cat. No. 2-115. 15 Watt Concord Deluxe Permanent System. Complete, ready to operate. All you have to do is set it up! System consists of 15 Watt Concord Deluxe Amplifier, two 12-inch G.E. PM speakers (see A below) each with 35 feet of cable. Shure model 707A20 microphone (see B on opposite page) with 20 feet of cable and a floor stand. Shipping weight 63 pounds. **Your Cost \$64.80**

Cat. No. 2-116. Same as 2-115 above except with a Turner model 22X microphone (see E on opposite page) and 20 feet of cable instead of the Shure model 707A20. Shipping weight 63 pounds. **Your Cost \$67.95**

Cat. No. 2-117. Same as 2-115 above except with a Electrovoice model 610-20 microphone (see C on opposite page) with 20 feet of cable instead of the Shure model 707A20. Shipping weight 63 pounds. **Your Cost \$70.95**

30 Watt Concord Deluxe Amplifiers and Systems

Cat. No. 2-106. 30 Watt Concord Deluxe Amplifier (shown on page at left) with tubes, instructions and necessary connecting plugs. Shipping weight 25 pounds. **Your Cost \$54.95**

Cat. No. 2-111. 30 Watt Concord Deluxe Portable System (shown above). You get everything you need ready to operate! All you have to do is set it up. System consists of 30 Watt Concord Deluxe Amplifier, two 12-inch G.E. Alnico V PM speakers with 70 feet of cable and mounted in carrying cases that also hold the amplifier, Shure model 707A20 microphone (see B on opposite page) with 20 feet of cable and a floor stand. Shipping weight 73 pounds. **Your Cost \$95.95**

Cat. No. 2-112. Same as 2-111 above except with a Turner model 22X microphone (see E on opposite page) with 20 feet of cable instead of the Shure model 707A20. Shipping weight 73 pounds. **Your Cost \$99.10**

Cat. No. 2-113. Same as 2-111 above except with a Electrovoice model 610-20 microphone (see C on opposite page) with 20 feet of cable, instead of the Shure model 707A20. Shipping weight 73 pounds. **Your Cost \$102.10**

Cat. No. 2-118. 30 Watt Concord Deluxe Permanent System. Complete, ready to operate. All you have to do is set it up! System consists of 30 Watt Concord Deluxe Amplifier, two 12-inch G.E. PM speakers (see A below) each with 35 feet of cable. Shure model 707A20 microphone (see B on opposite page) with 20 feet of cable and floor stand. Shipping weight 66 pounds. **Your Cost \$82.25**

Cat. No. 2-119. Same as 2-118 above except with a Turner model 22X microphone (see E on opposite page) and 20 feet of cable instead of the Shure model 707A20. Shipping weight 66 pounds. **Your Cost \$85.90**

Cat. No. 2-120. Same as 2-118 above except with a Electrovoice model 610-20 microphone (see C on opposite page) with 20 feet of cable instead of the Shure model 707A20. Shipping weight 66 pounds. **Your Cost \$88.90**





MOBILE AMPLIFIER SYSTEMS



32 Watt Amplifier and System

For the finest mobile installations—here are deluxe systems that have everything. 32 watts of power is provided at less than 5% distortion. 35 watts of power is available when needed.

Three separate input channels: two for high impedance microphones; one for high impedance phonograph. All can be mixed and faded. The Triple Range Electronic Tone Corrector provides the widest possible control of frequency response to compensate for the varying conditions encountered in mobile sound work. This exclusive feature permits individual boosting or attenuation of the bass and treble registers.

Completely self-contained. The constant speed phono-motor is protected by a hinged cover. A six-volt DC and 115-volt AC power supply is built in. Changeover is automatic and foolproof. A standby switch on the illuminated sloping control panel disconnects B supply, but keeps filaments heated. Battery consumption is reduced, component life is increased and the system is ready at all times for instant use. Provision is made for standby operation from a remote point. Nothing has been spared in making these systems the very finest in universal mobile sound systems. Used indoors or out, on 6-volt DC or 110-volt AC, they will provide rugged, faultless, high quality performance.

Cat. No. 2-122. 32 Watt Mobile Amplifier with phono for operation on 6-volt DC and 115-volt AC, 60 cycle. Complete with tubes and 6-volt and 115-volt power cables. Shipping weight 60 pounds. **\$147.00**

Cat. No. 2-126. 32 Watt Mobile Amplifier System. (Shown above.) Consists of 32 Watt Mobile Amplifier, 2 University Projectors each with a 25-watt driver unit and 35 feet of cable and a Turner model 9D Han-D-Dynamic microphone with 20 feet of cable. (See A below.) Shipping weight 93 pounds. **\$233.90**

Cat. No. 2-127. Same as 2-126 above except with a Electrovoice model 950 Cardax (see C below) and 20 feet of cable instead of the Turner model 9D Han-D-Dynamic microphone. Shipping weight 95 pounds. **Your Cost \$237.30**

Cat. No. 2-128. Same as 2-126 above except with a Shure model 55 Unidyne (see B below) and 20 feet of cable instead of the Turner model 9D Han-D-Dynamic microphone. Shipping weight 97 pounds. **Your Cost \$247.50**

SPECIFICATIONS — MODEL 2-122

POWER OUTPUT: 32 watts at less than 5%.
Peak power: 40 watts.

FREQUENCY RESPONSE: 30-12,000 cycles plus or minus 2 db.

GAIN: Microphone: 120 db. Phono: 70 db.

HUM: AC: —70 db; 6-volt DC: —60 db.

INPUT IMPEDANCE: Microphone channels (2), 500,000. Phono channel (1), 500,000 ohms.

OUTPUT IMPEDANCE: 4-8-15-250-500 ohms. Available at terminal strip and two built-in speaker sockets.

POWER CONSUMPTION: 120 watts, 117 V AC; 28 amps, 6 V DC.

TUBES: Total 8: 3—6SF5, 2—6SL7GT, 2—6L6G, 1—5U4G.

DIMENSIONS: 16 inches long, 16 inches wide, 10¼ inches high.

19-23 Watt Amplifier and System

Can be operated on either a 6-volt storage battery or on 115 volts AC. Conversion from one power supply to the other is automatic and fool-proof. Rated as a 20-watt amplifier, actually produces 23 watts on AC current and 19 watts on DC current at less than 5% distortion.

Two input channels are provided: one for high impedance microphone; one for the built-in constant speed phonograph. The 2 channels have gain controls and can be mixed and faded. The tone compensator effects individual control of treble and bass frequencies.

Two power switches, mounted on the four-color control panel, permit separate control of amplifier and phono-motor supply.

Inside and Out—here is a thoroughly engineered amplifier. Two-tube rectifier circuit, push-pull output, easily accessible controls and connectors, and terminal board mounted components.

Indoors and Out—These mobile systems are perfect for rallies, fairs, parades and straightforward indoor or outdoor PA work.

Cat. No. 2-121. 19-23 Watt Mobile Amplifier with phono for operation on 6-volt DC and 115-volt AC, 60 cycle. Complete with tubes and 6-volt and 115-volt power cables. Shipping weight 46 pounds. **\$98.49**

Cat. No. 2-123. 19-23 Watt Mobile Amplifier System. (Shown above.) Consists of 19-23 Watt Mobile Amplifier, 2 heavy duty GE 12-inch PM speakers each with 35 feet of cable, 2 spun steel sound projectors and a Turner model 9D Han-D-Dynamic microphone. (See A below.) Shipping weight 93 pounds. **\$148.40**

Cat. No. 2-124. Same as 2-123 above except with a Electrovoice model 950 Cardax (see C below) and 20 feet of cable instead of the Turner model 9D Han-D-Dynamic microphone. Shipping weight 95 pounds. **Your Cost \$151.65**

Cat. No. 2-125. Same as 2-123 above except with a Shure model 55 Unidyne (see B below) and 20 feet of cable instead of the Turner model 9D Han-D-Dynamic microphone. Shipping weight 97 pounds. **Your Cost \$161.75**

Cat. No. 22047. Adjustable Floor Stand. (See D below.) Adjustable from 35 inches to 68 inches. For use with any mobile system. Shipping weight 19 pounds. **Your Cost \$4.69**

SPECIFICATIONS — MODEL 2-121

POWER OUTPUT: AC: 23 watts at 5%; DC: 19 watts at 5%. Peak power: AC: 39 watts; DC: 30 watts.

FREQUENCY RESPONSE: 30-14,000 cycles plus or minus 2.5 db.

GAIN: Microphone channel: 109 db. Phono channel: 67 db.

HUM: AC: Fund.: —66 db; Mic.: —55 db. DC: Fund.: —69 db; Mic.: —58 db.

INPUT IMPEDANCE: Microphone channel (1): 500,000 ohms. Phono channel (1): 500,000 ohms.

OUTPUT IMPEDANCE: 4-8-15-250-500 ohms, available at both terminal strip and two speaker sockets.

POWER CONSUMPTION: 90 watts, 117 V AC; 17.5 amps, 6 V DC.

TUBES: Total 6: 1—6SJ7, 1—6SL7GT, 2—6L6G, 2—6X5GT.

DIMENSIONS: 15½ inches long, 10 inches deep, 12½ inches high.

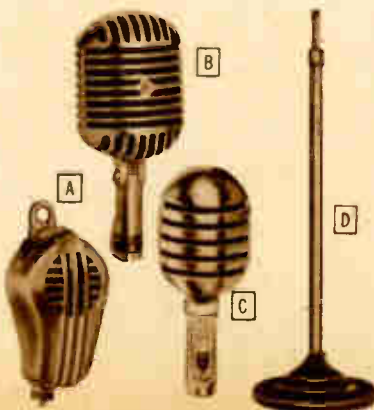

FOR **FLEXIBILITY, FIDELITY AND POWER**

MULTIAMP Add-A-Unit AMPLIFIERS

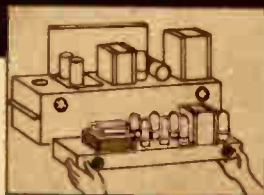

Plug-in power



15 output impedances



THIS-- NOT THIS

Only 2% harmonic distortion

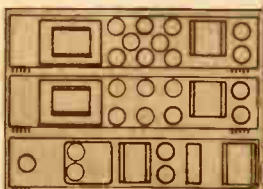

Add-A-Unit Chassis

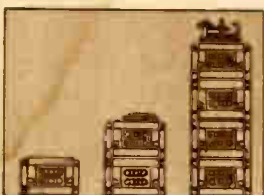

It expands with your needs

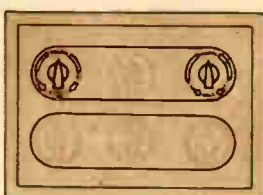

Dual tone control

*Engineered for Tomorrow—
Available Today*
IT'S EXCLUSIVE AT CONCORD

On the following pages Concord presents its Multiamp Amplifiers. An entirely modern line of amplifiers . . . modern in conception and design . . . modern in construction . . . modern in performance. These Multiamp Amplifiers are not prewar models in a new cabinet but are completely new inside and out. For all of the engineering "know how," the technical skill gained in over 15 years of work with sound systems has gone into Multiamp Amplifiers step by step to create an amplifier that is amazingly new and better in performance. The entire Multiamp line is an entirely new and original concept in amplifier design. Just compare the many features, and remember Multiamp Amplifiers are exclusive at Concord.

Plug-in Power For More Wattage At Less Cost

When you want more power you simply plug-in additional inexpensive power stages. Instead of requiring three different amplifiers to cover 30, 60 or 75 watt jobs you now need only one with inexpensive plug-in power stages. Yes, one Multiamp unit does the work of three for you can have 30, 60 or 75 watt power in one case.

Dual Tone Controls For Delicate Tone Shading

Every Multiamp Amplifier has separate bass and treble tone controls. You can accentuate or attenuate high or low frequencies without affecting the opposite frequency range. By attenuating both controls it is possible to limit the response of voice frequencies for maximum intelligibility. With this dual tone control you always have purity of tone even at full volume. You get faithful reproduction of even the most delicate tones.

15 Output Impedances For Greater Flexibility

You can match any combination of speakers indoors or outdoors. Whether your problem involves extra speakers, a special line, or some new piece of equipment such as a recorder you can easily and quickly solve it if your amplifier is a Concord Multiamp. The 15 output impedances are 1.3, 2.7, 4, 5.3, 8, 16, 125, 167, 180, 200, 250, 415, 460, 500 and 600 ohms. Inputs are provided to accommodate up to 2 microphones and 2 phono pickups.

Patented Focused Beam Circuit For Greater Efficiency

In conventional beam power circuits, under heavy load, during the portion of the cycle in which the plate potential drops considerably below the screen potential, electrons are diverted from their normal path and attracted to the screen resulting in excessive screen current (overload), distortion and shorter tube life. In Multiamp Amplifiers

this effect is greatly reduced by applying an initial plate potential appreciably higher than the screen potential and further supplying the screen voltage from a resistance network. This lowers the screen potential under heavy loads, resulting in fewer electrons being attracted to the screen, or diverted from the focused path thus avoiding screen overload, distortion and screen deterioration. This results in more than 50% additional undistorted output power and longer tube life, constant plate current, quality comparable to a class A triode, extreme stability, practically no driving power and only 2% harmonic distortion at the rated output. The cost is actually lower than a standard circuit giving less output.

EXPANDABLE—It Grows With Your Needs

Regardless of how small a Multiamp unit you start out with and regardless of how your needs change, your Multiamp Amplifier will never become obsolete. For the exclusive Add-A-Unit feature lets Multiamp grow with your needs. You can easily and quickly add an accessory phono player top, neon output indicator, automatic record changer, power stages or booster amplifier. You can increase a 30 watt Multiamp Amplifier to 60 or 75 watts and a 45 watt Multiamp Amplifier to 75 or 90 watts simply by plugging in a power stage. You don't have to buy a new amplifier!

Sturdily Constructed For Years and Years of Use

You can depend upon Multiamp Amplifiers for faithful service year after year because not even the smallest detail has been overlooked. All input and output jacks and connectors are recessed for protection. All high gain stages are shielded from the output and power stages insuring a low hum level. Carrying handles are recessed in the cast aluminum ends. The top is ventilated. The indirectly illuminated front panel has a smooth burgundy finish with ivory nomenclature. The rest of the cabinet has a two-tone wrinkle burgundy finish with aluminum trim. A matching chart for the 15 output impedances is printed on the bottom cover plate. The multiple chassis makes it easy to service unit by unit.

Multiamp's Value Has Been Proven By Use

Before a single Multiamp Amplifier was made, all of the designs and parts were tested and compared with other amplifiers by skilled sound engineers. Then, a little more than a year and a half ago, Multiamp Amplifiers were offered to Concord's customers. The acclaim of thousands of users during the first 18 months has proven what the laboratory technicians discovered—that Concord Multiamp is the best amplifier you can buy.

30 AND 45 WATT MULTIAMP

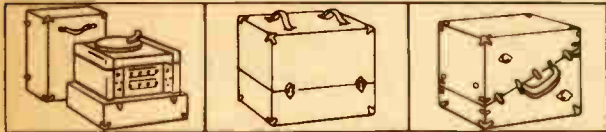

Amplifier in case Amplifier case closed Speaker case closed

It's Portable, It's

- ★ Plug-in power up to 90 watts
- ★ 15 separate output impedances
- ★ Individual bass and treble tone controls
- ★ Only 2% harmonic distortion at rated output
- ★ All accessory equipment fits into the base cabinet
- ★ Available in portable and permanent systems
- ★ 30 watt for audiences up to 3000; 45 watt up to 4500

Here is the flexible amplifier that you've always wanted—an amplifier that grows with your needs. For here is a 30 watt amplifier that can be increased to 60 or 75 watts and a 45 watt amplifier which can be increased to 75 or 90 watts just by plugging in an additional power unit. This "Add-A-Unit" feature of Concord's Multiamp Amplifiers makes the expense of a new amplifier unnecessary when a higher output is needed. You don't even need a new cabinet, for these power stages are built as integral plug-in units requiring only a screwdriver to change the overall output wattage of the amplifier.

Universal input and output. The inputs accommodate up to 2 microphones and 2 phono pickups. Input and output jacks and connectors are recessed to protect them from damage. Skillful designing of these units has shielded the high gain stages from the output and power stages to insure the lowest possible hum level. The 15 separate output impedances make it easy to match any combination of lines or speakers. The 15 output impedances are 1.3, 2.7, 4, 5.3, 8, 16, 125, 167, 180, 200, 250, 415, 460, 500 and 600 ohms.

Individual controls for bass and treble reproduction make possible delicate tone shading and full bodied volume as you can attenuate or accentuate either the high or low frequencies without affecting the opposite frequency range. By attenuating both of these controls it is possible to limit the response of voice frequencies for maximum intelligibility. This dual tone control and its resulting purity of tone is only one of the many features that make Concord Multiamp Amplifiers "tops" in the PA system field.

All accessory equipment fits into the same cabinet as the amplifier. You can add a phono top or an automatic record changer top and a visual type output meter and have one compact unit with all of the controls on the front panel within easy reach of the operator. The accurate visual type output meter enables even the inexperienced operator to monitor remote speakers and maintain proper output level. Essentially it consists of two neon indicators, one marked "Normal," and the other marked "Overload." A calibrated dial allows the operator to set the output at any predetermined value of the total amplifier output. When this pre-set level is reached, the first neon indicator lights. When the pre-set level is overloaded, the second neon indicator lights. Thus any operator can easily keep a close check on actual performance.

Portable system amplifiers are housed in a two piece carrying case attractively covered in handsome tan simulated rwhide leather. The pair of 12-inch PM dynamic speakers are housed in bass reflex enclosures for perfect bass response. These enclosures are so designed that they form a two-piece carrying case covered with the same material as the amplifier case. Each speaker has a 35-foot cable with male and female plugs.

Multiamp Amplifiers are the product of the finest engineering skill, nothing has been overlooked. The burgundy smooth tone front panel is illuminated by indirect lighting. Carrying handles are recessed in the cast aluminum ends. The top panel is ventilated. An output impedance chart is printed on the bottom cover plate. Cabinets have a two-tone burgundy wrinkle finish and polished aluminum trim. A line fuse is incorporated in each unit. They never become too small for your needs as they are expandable. Just Add-A-Unit as needed!

SPECIFICATIONS *

30 Watt Multiamp Amplifier

Output: 30 Watts, Normal, 60 Watts Peak Power.
Distortion: Total Harmonic, 2% or Less.
Channels:
 2 high gain microphone channels
 2 phono or program channels
Gain:
 Microphone Channels 116 db.
 Medium Gain Channels 80 db.
Tone Controls: 2—1 Bass, and 1 Treble, 25 db range.
Hum & Noise: Mike channels: 60 db below 30 watts.
Frequency Range: 30 to 10,000 cycles adjustable.
Impedance:
 1.3, 2.7, 4, 5.3, 8, 16, 125, 167, 180, 200, 250, 600 ohms.
Tube lineup: 2—6SQ7's, 1—7F7, 1—7A4, 4—6V6's & 2—7Z4
Line Drain: @ 117 volts, 60 cycle A.C. is 120 watts, with phono 140 watts.
Dimensions:
 18½" W x 14¼" D x 10¾" H, with phono 12¾" H, with changer 16" H.

45 Watt Multiamp Amplifier

All Specifications same as above except:
Output, Normal 45 watts, 90 watts Peak Power
Line current, 117 volts, 60 cycles, 165 watts, with phono 185 watts
Tube Lineup, 2—6SQ7's, 1—7F7, 1—7A4, 6—6V6's and 2—5Z4's

*All specifications shown on the Concord Amplifiers are based on using tubes having RMA average values, and line voltage set in the 120 volt tap position.

AMPLIFIERS AND SYSTEMS

Add + A + Unit 30-45 Watt Power Stage

Add + A + Unit Output Indicator

Add + A + Unit Phonograph Top

Add + A + Unit Record Changer

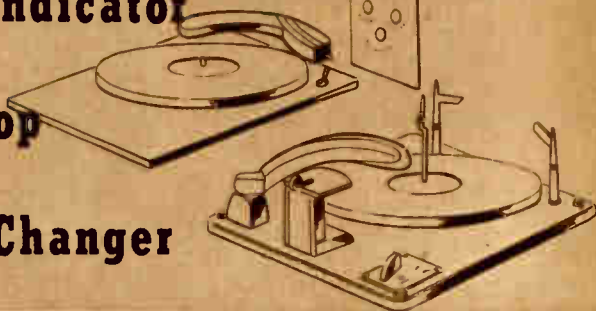
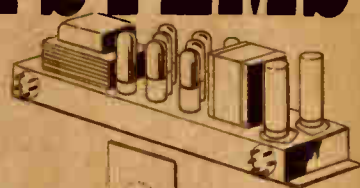

Permanent, It's Exclusive at Concord

30 Watt Multiamp Amplifiers and Systems

Cat. No. 2-200. 30 Watt Multiamp Amplifier. With tubes, instructions and connecting plugs. Shpg. wt. 38 lbs.

Your Cost **\$86.25**

Cat. No. 2-205. 30 Watt Multiamp Portable System. (Shown on page at left) You get everything you need ready to operate. All you have to do is set it up! System consists of 30 Watt Multiamp Amplifier in carrying case, two 12-inch G.E. PM speakers in carrying cases, Electrovoice Crystal microphone model 910-20 (see A below) with 20-feet of cable and a floor stand. Shpg. wt. 116 lbs.

Your Cost **\$142.60**

Cat. No. 2-206. Same as 2-205 above except with a Shure model 737A Monoplex Crystal microphone (see B below) and 20-feet cable, instead of Electrovoice 910-20 microphone. Shipping weight 116 lbs.

Your Cost **\$146.60**

Cat. No. 2-207. Same as 2-205 above but with a Electrovoice model 950 Cardax Crystal microphone (see C below) and 20-feet cable instead of Electrovoice 910-20 microphone. Shpg. wt. 116 lbs.

Your Cost **\$149.00**

Cat. No. 2-212. 30 Watt Multiamp Permanent System. You get everything you need including 30 Watt Multiamp Amplifier (shown on page at left), complete with tubes, connectors and, 70 ft. speaker cable two heavy duty 12-inch G.E. PM speakers (see G below), Electrovoice microphone model 910-20 (see A below) with 20-feet of cable and floor stand. Shipping weight 70 pounds.

Your Cost **\$114.95**

Cat. No. 2-213. Same as 2-212 above but with a Shure model 737A Monoplex Crystal microphone (see B below) and 20-feet of cable, instead of Electrovoice 910-20 microphone. Shpg. wt. 70 lbs.

Your Cost **\$118.95**

Cat. No. 2-214. Same as 2-212 above but with a Electrovoice model 950 Cardax Crystal microphone (see C below) and 20-feet of cable instead of Electrovoice 910-20 microphone. Shpg. wt. 70 lbs.

Your Cost **\$121.45**

45 Watt Multiamp Amplifiers and Systems

Cat. No. 2-201. 45 Watt Multiamp Amplifier. With tubes, instructions and connecting plugs. Shpg. wt. 47 lbs.

Your Cost **\$95.75**

Cat. No. 2-208. 45 Watt Multiamp Portable System. (Shown on page at left) You get everything you need ready to operate. All you have to do is set it up! System consists of 45 Watt Multiamp Amplifier in carrying case, two 12-inch GE P.M. speakers in carrying cases, Electrovoice Crystal microphone model 910-20 (see A below) with 20-feet of cable and a floor stand. Shpg. wt. 120 lbs.

Your Cost **\$152.10**

Cat. No. 2-209. Same as 2-208 above but with a Shure model 737A Monoplex Crystal microphone (see B below) and 20-feet of cable instead of Electrovoice 910-20 microphone. Shpg. wt. 120 lbs.

Your Cost **\$156.10**

Cat. No. 2-210. Same as 2-208 but with a Electrovoice model 950 Cardax Crystal microphone (see C below) and 20-feet of cable, instead of Electrovoice 910-20 microphone. Shpg. wt. 120 lbs.

Your Cost **\$158.50**

Cat. No. 2-215. 45 Watt Multiamp Permanent System. You get everything you need including 45 Watt Multiamp Amplifier (shown on page at left) complete with tubes, connectors and 70 ft. of speakers cable, two heavy duty G.E. 12-inch PM speakers (see G below), Electrovoice Crystal microphone model 910-20 (see A below) with 20-feet of cable and a floor stand. Shpg. wt. 74 pounds.

Your Cost **\$124.45**

Cat. No. 2-216. Same as above but with a Shure model 737A Monoplex Crystal microphone (see B below) and 20-feet of cable, instead of Electrovoice 910-20 microphone. Shpg. wt. 74 lbs.

Your Cost **\$128.45**

Cat. No. 2-217. Same as 2-215 above but with a Electrovoice model 950 Cardax Crystal microphone (see C below) and 20-feet of cable instead of Electrovoice 910-20 Microphone. Shpg. wt. 74 lbs.

Your Cost **\$130.95**

Accessories For Multiamp Amplifiers and Systems

Cat. No. 2-202. Phono Player accessory top for Multiamp Amplifiers. (Shown on page 29) Shpg. wt. 10 lbs.

Your Cost **\$11.75**

Cat. No. 2-203. Automatic Record Changer Accessory Top for Multiamp Amplifiers. (Shown on page 29) Shpg. wt. 19 lbs. Will not fit in portable system.

Your Cost **\$30.75**

Cat. No. 2-204. Neon Output Indicator for Multiamp Amplifiers. (Shown on page 29) Shpg. wt. 2 lbs.

Your Cost **\$4.75**

Cat. No. 20051. Walnut Wall Baffle. (See F below) Designed to emphasize bass responses. They spread sound over wide areas. Ideal for use with most permanent systems. Shpg. wt. 8 lbs. each.

Your Cost **each \$5.25**

In Pairs **each \$4.95**

Cat. No. 20077. Deluxe All-Steel Projector (see E below) For use with 12-inch speakers. Designed to direct sound and carry it farther than wall baffles. They create a crisp penetrating tone. Use with any of the permanent systems above. Shpg. wt. 13 lbs.

Your Cost **\$10.53**



60 AND 75 WATT MULTIAMP

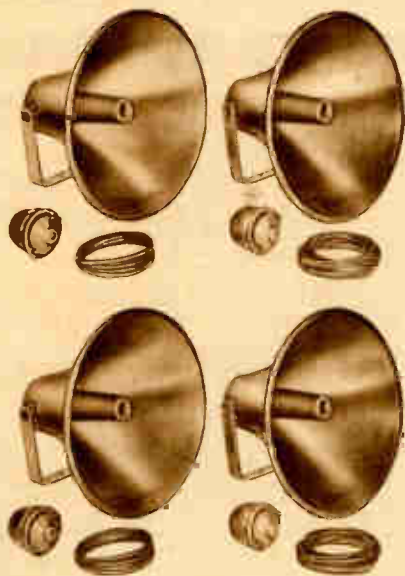

They're Powerful—

- ★ Only 2% total harmonic distortion at rated output
- ★ 15 individual output impedances
- ★ Separate treble and bass tone controls
- ★ Can be used indoors or outdoors
- ★ All accessories fit into the same cabinet
- ★ Designed for those who want power and flexibility
- ★ 60 watt covers audiences up to 6000
- ★ 75 watt covers audiences up to 7500

Concord 60 and 75 watt Multiamp Amplifiers mean power... power to cover the entire crowd, so that everybody can easily hear... power enough for fair grounds, athletic fields, halls and factories... power that brings every sound, every note, every tone to every ear. Here are 60 and 75 watt amplifiers with separate bass and treble tone controls, 15 individual output impedances and all of the other many famous Multi-amp features.

All accessory equipment fits into the same cabinet as your amplifier. You can add a phono player top or an automatic record changer and visual type output indicator and still have a single compact unit with all of the controls on the front panel.

When more power is what you need additional output stages can be utilized as booster amplifiers. A monitoring speaker of the PM type can be mounted on the grille on the front panel of the cabinet to be used with these booster units. These units will stack on top of each other and connect with the original amplifier so that almost any situation can be handled in one installation. For additional details on power stages and booster amplifiers for Multiamp Amplifiers see the following pages.

A neon output indicator is only one of the many Add-A-Unit accessories that can be easily installed in these amplifiers. For information on this visual type output meter see the preceding pages.

The single player phono top is an accessory that when combined a Multiamp Amplifier opens the door to a new world of high fidelity musical reproduction. Churches, chapels and mortuaries that require top quality humless and distortion free reproduction of organ music, bells and chimes will find this phono top and a Multiamp Amplifier the ideal combination. Skating rinks, dance pavilions and other users of dance music recordings will enjoy the faithful reproduction of even the highest notes. Anyone can easily install this player phono top on any Multiamp Amplifier. The only tool you need is a screwdriver. This single record player top has a high quality crystal pickup and a single speed motor.

The automatic record changer top plays 10 twelve inch records or 12 ten inch records automatically, with the completion of the last record it stops automatically. It is an accessory that can be quickly installed on any Multiamp Amplifier. This unit is ideal for supplying background or dance music in restaurants or other places that desire continuous entertainment as you may have thirty minutes of uninterrupted music from ten inch records. Stores will find it just the thing for bellyho or sales promotion purposes. The record support is of the single shelf type. The unit has a single speed 78 r.p.m. motor and a true tangent tone arm with a high quality crystal pickup.

The modern design cabinets have cast aluminum sides with recessed handles, illuminated front panel, two-tone burgundy finish and all of the other features found in the 30 and 45 watt Multiamp Amplifiers. 60 and 75 watt Multiamp Amplifiers are also available in portable systems. Write to our Technical Advisory Service for details.

SPECIFICATIONS*

60 Watt Multiamp Amplifier

Output: 60 Watts, Normal, 120 Watts Peak Power
Distortion: Total Harmonic, 2% or less
Channels:
 2 high gain microphone channels
 2 phono or program channels
Gain:
 Microphone Channels 116 db.
 Medium Gain Channels 80 db.
Tone Controls: 1 Bass equalizer and 1 Treble, 25 db range.
Hum & Noise: Mike channels: 60 db below 60 watts.
 Frequency Range 30 to 10,000 cycles adjustable.
Output impedances:
 1.3, 2.7, 4, 5.3, 8, 16, 125, 167, 180, 200, 250, 415, 460,
 500, and 600 ohms.
Tube line up: 2-6SQ7's, 1-7F7, 1-7A4, 8-6V6GT's and 4-7Z4's
Line Drain: @ 117 volts, 60 cycle A.C., is 200 watts,
 with phono 220 watts.
Dimensions:
 18½" W x 14¼" D x 10¾" H, with phono 12¾" H, with changer
 16" H

75 Watt Multiamp Amplifier

All Specifications same as above except as follows:
Output: 75 Watts Normal, 150 Watts Peak Power
Line Drain: @ 117 volts, 60 cycle A.C., is 245 watts,
 with phono 265 watts.
Tube line-up: 2-6SQ7's, 1-7F7, 1-7A4, 10-6V6 GT's, 2-7Z4's,
 and 2-8Z4's
 * All specifications shown are based on using tubes having RMA
 average values and line voltage set in the 120 volt tap position.

AMPLIFIERS AND SYSTEMS



They're Expandable - They're Economical

60 Watt Multiamp Amplifiers and Systems

Cat. No. 2-218. 60 Watt Multiamp Amplifier. Complete with tubes, instructions and connecting plugs. Sh. wt. 51 lbs.
Your Cost. **\$120.95**

Cat. No. 2-220. 60 Watt Deluxe Multiamp Permanent System. (Shown on page at left). You get everything you need. All you have to do is set it up! System consists of 60 watt Multiamp Amplifier, 4 University trumpets and driver units each with 35-ft. of speaker cable, floor stand and Electrovoice Model V1 Velocity microphone (see C below) with 20-ft. of cable. Shipping weight 120 pounds.
Your Cost. **\$288.25**

Cat. No. 2-221. Same as 2-220 above but with a Shure Sonodyne Model 51 Dynamic microphone (see B below) instead of Electrovoice V1 Velocity microphone. Shipping weight 120 pounds.
Your Cost. **\$288.00**

Cat. No. 2-222. Same as 2-220 above but with a Turner U9S Dynamic microphone, (see A below) instead of Electrovoice V1 Velocity microphone and 20-ft. of cable. Shipping weight 120 pounds.
Your Cost. **\$292.30**

Cat. No. 2-226. 60 Watt Multiamp Permanent System. Everything is ready to operate. All you do is set it up. System consists of 60 watt Multiamp Amplifier, 4 heavy duty 12-inch GE PM speakers each with 35-ft. of speaker cable (see E below), floor stand and Electrovoice Model V1 Velocity microphone (see C below), with 20-ft. of cable. Shipping weight 99 pounds.
Your Cost. **\$171.75**

Cat. No. 2-227. Same as 2-226 above but with a Shure Sonodyne Model 51 Dynamic microphone (see B below), instead of Electrovoice V1 Velocity microphone. Shipping weight 99 pounds.
Your Cost. **\$171.50**

Cat. No. 2-228. Same as 2-226 above but with a Turner U9S Dynamic microphone, (see A below) instead of Electrovoice V1 Velocity microphone, and 20-ft. of cable. Shipping weight 99 lbs.
Your Cost. **\$175.80**

Cat. No. 2-202. Phono Player Accessory Top for Multiamp Amplifiers. (Shown above.) Sh. wt. 10 lbs.
Your Cost. **\$11.75**

Cat. No. 2-203. Automatic Record Changer Accessory Top for Multiamp Amplifiers. (Shown above.) Will not fit in portable systems. Shipping weight 19 pounds.
Your Cost. **\$30.75**

Cat. No. 2-204. Neon Output Indicator for Multiamp Amplifiers. (Shown above.) Shipping weight 2 pounds.
Your Cost. **\$4.75**

75 Watt Multiamp Amplifiers and Systems

Cat. No. 2-219. 75 Watt Multiamp Amplifier. Complete with tubes, instructions and connecting plugs. Sh. wt. 58 lbs.
Your Cost. **\$130.40**

Cat. No. 2-223. 75 Watt Deluxe Multiamp Permanent System. (Shown on page at left). You get everything you need. All you have to do is set it up. System consists of 75 watt Multiamp Amplifier, 4 University trumpets and driver units each with 35-ft. of speaker cable, floor stand and Electrovoice Model V1 Velocity microphone (see C below) with 20-ft. of cable. Shpg. wt. 127 lbs.
Your Cost. **\$297.70**

Cat. No. 2-224. Same as 2-223 above but with a Shure Sonodyne Model 51 Dynamic microphone (see B below) instead of Electrovoice V1 Velocity microphone. Shpg. wt. 127 lbs.
Your Cost. **\$297.45**

Cat. No. 2-225. Same as 2-223 but with a Turner U9S Dynamic microphone (see A below) instead of Electrovoice V1 Velocity microphone and 20-ft. of cable. Shipping weight 127 pounds.
Your Cost. **\$301.75**

Cat. No. 2-229. 75 Watt Multiamp Permanent System. Everything is ready to operate. All you do is set it up. System consists of 75 watt Multiamp Amplifier, 4 heavy duty 12-inch GE PM speakers, each with 35-ft. of speaker cable (see E below), floor stand and Electrovoice Model V1 Velocity microphone with 20-ft. of cable. Sh. wt. 106 lbs.
Your Cost. **\$181.20**

Cat. No. 2-230. Same as 2-229 above but with a Shure Sonodyne Model 51 Dynamic microphone, instead of the Electrovoice V1 Velocity microphone (see B below). Shipping weight 106 pounds.
Your Cost. **\$180.95**

Cat. No. 2-231. Same as 2-229 above but with a Turner U9S Dynamic microphone (see A below) instead of the Electrovoice V1 Velocity microphone and 20-ft. of cable. Shipping weight 106 pounds.
Your Cost. **\$189.15**

Cat. No. 20051. Walnut Wall Baffle. (See G below). Designed to emphasize bass responses it spreads the sound over wide areas. Ideal for use with any permanent system. Ship. wt. 8 lbs. each.
Your Cost. each **\$5.25**
In pairs each **\$4.95**

Cat. No. 20077. Deluxe All-Steel Projector. (See F below). For use with 12-inch speakers. Designed to direct sound and carry it farther than wall baffles they create a crisp penetrating tone. Use with any system above. Shipping weight 13 pounds.
Your Cost. **\$10.53**

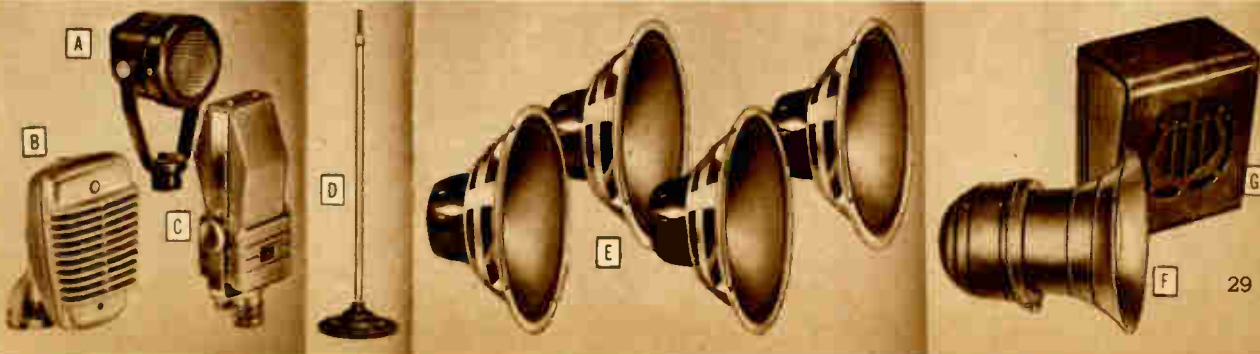

90 WATT MULTIAMP AMPLIFIER

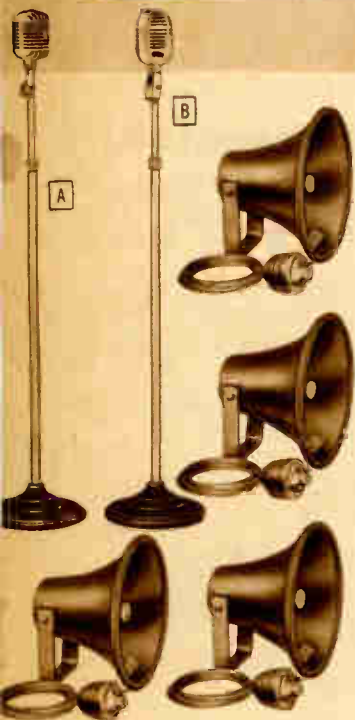

Complete System for High Power Installations

- ★ Multiple chassis
- ★ 15 output impedances
- ★ Only 2% harmonic distortion
- ★ Individual bass and treble tone controls
- ★ Inputs accommodate up to 2 microphones and 2 phono pickups

Here is an amplifier that has power enough for every type of operation indoors or out. Here is a superbly engineered unit that's packed with the newest and best developments for outstanding performance in high power amplifiers. Here is a Concord 90 Watt Multiamp Amplifier.

Regardless of how your requirements may change this amplifier never becomes obsolete because it has all of the famous Multiamp features. You can quickly and easily add a 30 to 90 watt booster amplifier, a phono player top, output indicator, automatic record changer or any of the many Multiamp accessories. The 15 output impedances allow you to match almost any combination of lines and speakers. The individual bass and treble tone controls plus a maximum of 2% harmonic distortion insure faithful reproduction of even the most delicate tones and allows you to limit the response of voice frequency for greatest intelligibility. The multiple unit chassis makes it easy to service unit by unit. Get the power you need, order a Multiamp Amplifier today.

Cat. No. 2-232. 90 Watt Multiamp Amplifier. Complete with tubes, instructions and all necessary connecting plugs. Shipping weight 65 pounds. **Your Cost \$139.80**

Cat. No. 2-233. 90 Watt Multiamp High Power Amplifier System. (Shown above.) You get everything you need, there's nothing else to buy. System consists of a 90 Watt Multiamp Amplifier, 4 University trumpets each with a 25 watt driver unit and 35 feet of cable, a Shure model 55 Unidyne microphone with 25 feet of cable (see A above) and a floor stand. Shipping weight 130 pounds. **Your Cost \$316.25**

Cat. No. 2-234. Same as 2-233 above but with an Electrovoice model 726 Cardyne Dynamic microphone, (see B above) instead of the Shure model 55 Unidyne microphone. Shipping weight 130 pounds. **Your Cost \$318.25**

Cat. No. 2-202. Accessory Phono Player Top for Multiamp Amplifiers. (Shown on page 29.) Shipping weight 10 pounds. **Your Cost \$11.50**

Cat. No. 2-203. Accessory Automatic Record Changer Top for Multiamp Amplifiers. (Shown on page 29.) Sh. wt. 19 lbs. **Your Cost \$30.75**

Cat. No. 2-204. Accessory Neon Output Indicator for Multiamp Amplifiers. (Shown on page 29.) Shipping weight 2 pounds. **Your Cost \$4.75**

MULTIAMP ADD-A-UNIT CENTRALIZED SOUND SYSTEMS

Unlimited Output... Unlimited Input Channels
Immediate Delivery!

Concord Multiamp Add-A-Unit Amplifiers make it possible to assemble in a matter of minutes what would ordinarily be custom built systems with unlimited output wattage requiring technicians hours to install. Equipment with power outputs greater than 100 watts or with facilities for special inputs, impedances and other features which vary with each installation were always considered to be in the custom built class. This in turn meant extremely high costs and little or no flexibility once the equipment was manufactured to special requirements. But the extreme flexibility of Concord's Multiamp Add-A-Unit Amplifiers makes this custom built equipment standard stock items! Facilities for unlimited wattage output, phono players, automatic record changer, output indicator and many other accessories are available and may be included in a stacked cabinet assembly as illustrated at the left... and all at the low cost of regular stock items instead of the usual high cost of custom built installations.

Solve your sound system problems the easy, economical way by installing Multiamp Add-A-Unit Amplifiers. Write to Concord's free Technical Advisory Service for complete details of how to fill your public address needs to perfection.





A



B

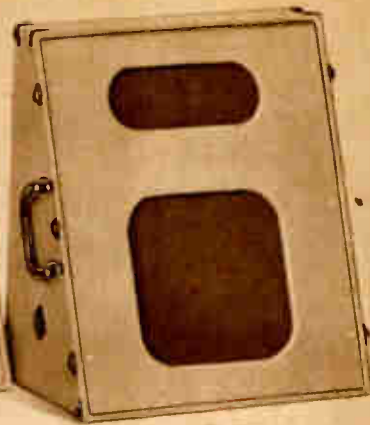

C



D



E

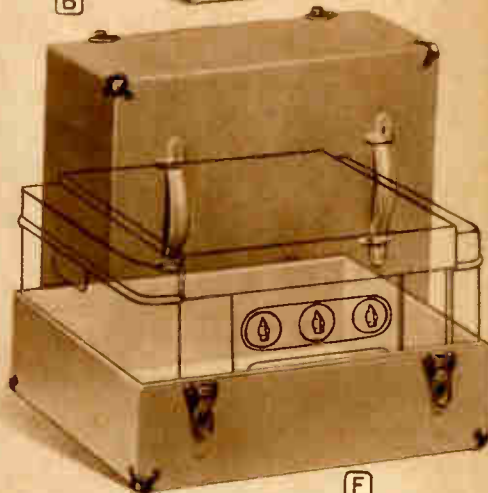

F

Multiamp Booster Amplifiers and Accessories

ⓓ Multiamp Plug-In Power Stages

Multiamp plug-in power stages are the same high quality output stages used with the 30 and 45 watt Multiamp Amplifiers. Like all Multiamp Amplifiers they have a maximum harmonic distortion of only 2% at rated output. These units may be used to increase the power output of any 30 or 45 watt Multiamp Amplifier simply by plugging it into the basic unit. This installation takes only a few seconds and does not require the use of any special tools or the assistance of a technician. The 30 watt Multiamp power stage uses four 6V6 and two 7Z4 tubes. The 45 watt Multiamp power stage uses six 6V6 and two 5Z4 tubes. Overall sizes: 17½ inches wide by 4¾ inches deep by 5½ inches high.

Cat. No. 2-237. 30 watt Multiamp plug-in power stage (see D above) complete with tubes. Shpg. wt. 16 lbs. **\$36.65**

Cat. No. 2-238. 45 watt Multiamp plug-in power stage (see D above) complete with tubes. Shipping weight 18 pounds. **Your Cost \$46.10**

ⓐ Multiamp Booster Amplifiers

Multiamp Booster Amplifiers are designed for use with Concord Multi-amp Amplifiers to increase the power output of the unit to which they are added by values to total up to 270 watts of output. Amplifiers with this extremely high output are especially designed for use in baseball parks, race tracks, stadiums and all other outdoor or indoor locations requiring great sound coverage. Booster Amplifiers come in 30 and 45 watt power output. Their harmonic distortion is only 2% at the rated output. They have 15 output impedances and all of the other Multiamp features described in the preceding pages. Booster Amplifiers are identical to the Multiamp Power Stages described above but in addition includes a cabinet that is of the same modern design as the Multiamp Amplifier cabinet. This cabinet has provision for a monitor speaker. The bottom is designed to recess and stack on top of other Booster Amplifiers. 30 watt unit can be increased to 60 or 75 watts and the 45 watt unit to 75 or 90 watts by adding plug-in power stages.

Cat. No. 2-235. 30 watt Booster Amplifier (see C above) complete with tubes. Shipping weight 36 pounds. **Your Cost \$61.45**

Cat. No. 2-236. 45 watt Booster Amplifier (see C above) complete with tubes. Shipping weight 38 pounds. **Your Cost \$70.90**

ⓑ Portable Bass Reflex Speaker Enclosure

Two 12-inch permanent magnet dynamic speakers are housed in these reflex enclosures to insure perfect bass response. The enclosures are so designed that they form a two-piece portable carrying case attractively covered in handsome tan simulated rawhide leather. Each speaker has 35 feet of speaker cable complete with male and female plugs. Recessed receptacles guard connectors against damage. Overall size: 14 inches by 19¼ inches by 21¼ inches.

Cat. No. 22055. Shipping weight 25 pounds. **Your Cost \$14.50**

Ⓕ Portable Multiamp Amplifier Carrying Case

Covered in the same fine material it matches the speaker enclosure described above. Top can be completely removed, so that the amplifier is easily accessible, simply by opening the four strong snap locks. Two sturdy handles covered in simulated leather make carrying easy. All corners are protected by metal shields and bottom has metal feet. Overall size: 15 inches by 15½ inches by 20 inches.

Cat. No. 22057. Shipping weight 17 pounds. **Your Cost \$9.75**

Ⓖ Combination Amplifier and 12-inch Speaker Carrying Case

A carrying case that holds two 12-inch speakers plus an amplifier! Made of ¾-inch thick plywood covered with beautiful tan simulated rawhide leather. Lock-corner construction with metal corner shields for added protection. Four snap locks hold case securely closed. Simulated leather handles make carrying easy. Amplifier fits on a board that slides in or out of the case quickly and easily. Although this case was designed for Concord Deluxe Amplifiers it will hold any amplifier that is 15 inches by 10 inches by 8¾ inches. Overall size of case: 14¼ inches by 18¼ inches by 21½ inches.

Cat. No. 22056. Shipping weight 24 pounds. **Your Cost \$11.25**

Ⓗ Combination Amplifier and 8-inch Speaker Carrying Case

A carrying case that holds an amplifier and an 8-inch speaker. Beautiful tan simulated rawhide leather covers strong ¼-inch plywood. Lock-corner construction, 4 sturdy snap locks and a thick simulated leather carrying handle make it a case you can trust with your equipment. Overall size: 12 inches by 11 inches by 15½ inches.

Cat. No. 22058. Shipping weight 10 pounds. **Your Cost \$6.95**



RCA CONCORD

RADIO TUBES

The Finest Names in Radio Tube Perfection



Type	NET PRICES	
	RCA Ea.	Lots CON-GE of 50 CORD Each
OZ4	\$1.23	\$1.16
OZ4G	1.23	1.16 \$0.98
1A3	1.01	.95 .80
1A4P	1.79	1.69
1A5GT/G	.84	.79 .67
1A6	1.48	1.40
1A7GT	1.01	.95 .80
1B3GT 8016	2.18	2.06
1B4P	1.79	1.69
1B5/25S	1.48	1.40
1C5GT/G	1.01	.95
1C6	1.48	1.40
1C7G	1.48	1.40
1D5GP	1.79	1.69
1D7G	1.48	1.40
1D8GT	1.79	1.69
1E5GP	2.18	2.06
1F4	1.23	1.16
1F5G	1.23	1.16
1F6	1.79	1.69
1F7G	1.79	1.69
1G4GT/G	1.23	1.16
1G5G	1.23	1.16
1G6GT/G	1.23	1.16
1H4G	1.01	.95 .80
1M5GT/G	.84	.79 .67
1M6G	1.48	1.40
1J6GT	1.48	1.40
1L4	1.01	.95 .80
1LA4	1.48	1.40
1LA6	1.48	1.40
1LB4	1.48	1.40
1LM4	1.48	1.40
1LN5	1.48	1.40
1NSGT/G	1.01	.95 .80
1P5GT	1.23	1.16 .98
1Q5GT/G	1.23	1.16 .98
1R5	1.01	.95 .80
1S4	1.23	1.16 .98
1S5	1.23	1.16 .98
1T4	1.01	.95 .80
1T5GT	1.23	1.16
1U4	1.01	.95
1V	1.01	.95 .80
2A3	1.48	1.40 1.18
2A5	1.01	.95 .80
2A6	1.23	1.16
2A7	1.23	1.16 .98
2B7	1.23	1.16 .98
2E5	1.23	1.16 .98
3A4	1.05	.90 .69
3Q4	1.01	.95 .80
3Q5GT/G	1.23	1.16 .98
3S4	1.01	.95 .80
3V4	1.01	.95 .80
5T4	1.79	1.69
5U4G	.75	.71 .60
5V4G	1.23	1.16 .98
5W4	1.23	1.16
5W4GT/G	.70	.66 .56
5X4G	.84	.79 .67
5Y3GT/G	.53	.50 .42
5Y4G	.70	.66 .56
5Z3	.84	.79 .67
5Z4	1.23	1.16
6A3	1.48	1.40
6A4/LA	1.48	1.40
6A6	1.23	1.16
6A7	1.01	.95 .80
6A8	1.01	.95
6A8G	1.01	.95
6A8GT	1.01	.95 .80
6AB5/6N5	1.23	1.16
6AB7 1853	1.48	1.40
6AC5GT/G	1.23	1.16 .98

Type	NET PRICES	
	RCA Ea.	Lots CON-GE of 50 CORD Each
6AC7 1852	\$1.48	\$1.40
6AD7G	1.48	1.40
6AE5GT/G		
6AF6G	1.23	1.16
6AG5	1.48	1.40
6AG7	1.48	1.40
6AK6	1.23	1.16
6AL5	1.01	.95
6AL7GT	1.48	1.40
6AQ5	1.01	.95 \$.80
6AQ6	1.01	.95
6AT6	.84	.79 .67
6AU6	1.01	.95 .80
6BA6G	1.48	1.40 1.18
6B5	1.48	1.40
6B6G	1.01	.95
6B7	1.48	1.40 1.18
6B8	1.48	1.40
6B8G	1.48	1.40 1.18
6BA6	1.01	.95 .80
6BE6	1.01	.95 .80
6BF6	.84	.79
6BG6G	2.68	2.54
6C4	.84	.79
6C5	.84	.79
6CSGT/G	.84	.79
6C6	1.01	.95 .80
6C8G	1.48	1.40 1.18
6D6	.84	.79 .67
6D8G	1.48	1.40 1.18
6E5	1.01	.95 .80
6F5	.84	.79
6F5GT/G	.84	.79 .67
6F6	1.01	.95
6F6G	.84	.79
6F6GT	.84	.79 .67
6F7	1.48	1.40 1.18
6F8G	1.48	1.40 1.18
6GG6	1.23	1.16 .98
6H6	.84	.79
6HG6T	.84	.79 .67
6J5	.75	.71
6J5GT/G	.75	.71 .60
6J6	1.48	1.40
6J7	1.01	.95
6J7G	1.01	.95
6J7GT	1.01	.95 .80
6K5GT/G	.75	.71 .60
6K7	.84	.79
6K7G	.84	.79
6K7GT	.84	.79 .67
6K8	1.23	1.16
6K8G	1.48	1.40
6K8GT	1.01	.95 .80
6L5G	1.23	1.16
6L6	1.79	1.69
6L6G	1.48	1.40
6L7	1.23	1.16
6L7G	1.48	1.40
6N7	1.23	1.16
6N7GT/G	1.23	1.16
6Q7	1.01	.95
6Q7G	.84	.79
6Q7GT	.84	.79 .67
6R7	1.23	1.16
6R7GT/G	1.01	.95 .80
6S7	1.23	1.16
6S7G	1.48	1.40
6SA7	.84	.79
6SA7GT/G	.84	.79 .67
6SB7Y	1.23	1.16
6SC7	1.01	.95
6SC7GT		
6SD7GT	1.48	1.40 1.18
6SF5	.84	.79
6SF5GT	1.01	.95 .80
6SF7	1.01	.95
6SG7	1.01	.95
6SH7	1.01	.95
6SH7GT		

Type	NET PRICES	
	RCA Ea.	Lots CON-GE of 50 CORD Each
6SJ7	\$.84	\$.79
6SJ7GT	.84	.79 \$.67
6SK7	.84	.79
6SK7GT/G	.84	.79 .67
6SL7GT	1.23	1.16 .98
6SN7GT	1.23	1.16 .98
6SQ7	.75	.71
6SQ7GT/G	.84	.79 .67
6SR7	.84	.79
6SS7	1.01	.95
6ST7	1.23	1.16
6TTG	1.48	1.40
6U5/6G5	1.01	.95 .80
6U7G	.84	.79 .67
6V6	1.48	1.40
6V6GT/G	1.01	.95 .80
6W7G	1.23	1.16 .98
6X4	.84	.79 .67
6X5	1.23	1.16
6X5GT/G	.75	.71 .60
6Y6G	1.23	1.16 .98
6Z4/84	.84	.79 .67
6Z7G	1.79	1.69
6ZY5G	1.01	.95 .80
7A4	1.01	.95 .80
7A5	1.01	.95 .80
7A6	1.01	.95 .80
7A7	1.01	.95 .80
7AG7	1.23	1.16
7B4	1.01	.95 .80
7B5	1.01	.95 .80
7B6	1.01	.95 .80
7B7	1.01	.95 .80
7B8	1.01	.95 .80
7C5	1.01	.95 .80
7C6	1.01	.95 .80
7C7	1.01	.95 .80
7E6	1.01	.95 .80
7E7	1.23	1.16 .98
7F7	1.23	1.16 .98
7F8	1.48	1.40
7G7/1232	1.48	1.40 1.18
7M7	1.23	1.16 .98
7J7	1.48	1.40 1.18
7N7	1.23	1.16 .98
7Q7	1.01	.95 .80
7W7	1.48	1.40
7Y4	1.01	.95
7Z4	1.01	.95 .80
10	2.18	2.06
12A7	1.48	1.40 1.18
12A8GT/G	1.01	.95 .80
12A8GT	1.23	1.16
12AL5	1.01	.95
12AT6	.84	.79 .67
12AU6	1.01	.95
12AU7	1.23	1.16
12BE6	1.01	.95 .80
12C8	1.48	1.40
12F5GT	.84	.79
12H6	.84	.79
12J5GT	.75	.71 .60
12J7GT/G	1.01	.95 .80
12K7GT/G	.84	.79 .67
12K8	1.23	1.16
12Q7GT/G	.84	.79 .67
12SA7	.84	.79
12SA7GT/G	1.01	.95 .80
12SC7	1.01	.95
12SF5	.84	.79
12SF7	1.01	.95
12SG7	1.01	.95
12SH7	1.01	.95
12SJ7	.84	.79
12SJTGT	.84	.79 .67

Type	NET PRICES	
	RCA Ea.	Lots CON-GE of 50 CORD Each
12SK7	\$.84	\$.79
12SK7GT/G	.84	.79 \$.67
12SL7GT	1.23	1.16 .98
12SN7GT	1.23	1.16 .98
12SQ7	.75	.71
12SQ7GT/G	.84	.79 .67
12SR7	1.01	.95
12Z3	1.23	1.16 .98
15	1.48	1.40
19	1.48	1.40
24A	1.01	.95 .80
25A6	1.48	1.40
25L6	1.48	1.40
25L6GT/G	.84	.79 .67
25Z5	.75	.71 .60
25Z6	1.01	.95
25Z6GT/G	.75	.71 .60
26	.84	.79 .67
27	.75	.71 .60
30	1.01	.95 .80
31	1.23	1.16
32	1.48	1.40 1.18
33	1.48	1.40 1.18
34	1.48	1.40 1.18
35	1.01	.95 .80
35A5	1.01	.95
35B5	1.01	.95 .80
35L6GT/G	.84	.79 .67
35W4	.64	.61 .51
35Y4	1.23	1.16 .98
35Z3	1.01	.95 .80
35Z4GT	.70	.66 .56
35Z5GT/G	.64	.61 .51
36	1.23	1.16 .98
37	.84	.79 .67
38	1.01	.95 .80
39/44	1.23	1.16 .98
41	.84	.79 .67
42	.84	.79 .67
43	.84	.79 .67
45	.84	.79 .67
45Z3	.84	.79
45Z5GT	.84	.79 .67
46	1.23	1.16 .98
47	1.23	1.16 .98
49	1.23	1.16
50	2.18	2.06
50B5	1.01	.95 .80
50L6GT	.84	.79 .67
50Y6GT	.84	.79
53	1.23	1.16
55	1.01	.95
56	.84	.79 .67
57	1.01	.95 .80
58	1.01	.95 .80
59	1.48	1.40
70L7GT	2.18	2.06 1.74
71A	1.01	.95 .80
75	.84	.79 .67
76	.84	.79 .67
77	.84	.79 .67
78	.84	.79 .67
79	1.23	1.16
80	.59	.56 .47
81	1.79	1.69 1.43
82	1.23	1.16 .98
83	1.23	1.16 .98
83V	1.48	1.40
85	1.01	.95
89	1.01	.95
117L7 M7GT	2.18	2.06 1.74
117N7GT	2.18	2.06 1.74
117P7GT	2.18	2.06 1.74
117Z3	1.01	.95 .80
117Z6GT/G	1.23	1.16 .98

All Tubes Guaranteed for 6 Months Except for Burnouts and Breakage

Intercommunication Systems

SPECIAL DELUXE

DELUXE

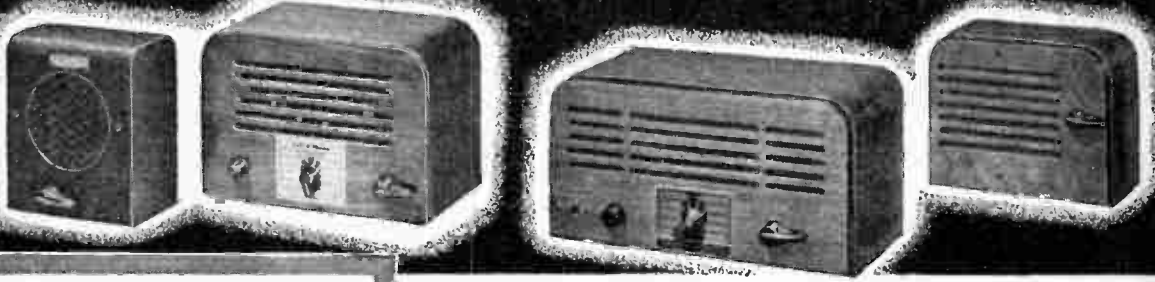

Master Selective Systems

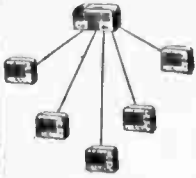

Fig. I

Master Selective Systems consist of one Master Station and up to ten Sub-Stations. You can build your system progressively beginning with the Master Station and one Sub-Station, and adding other Sub-Stations as the need develops. Master Station may call any Sub Station individually, or may call all Sub Stations simultaneously. Sub-Stations may call Master but not each other. Master Selective Systems feature **Silent Operation**—shuts out all sounds from Sub Station locations when not in use.

How to Estimate Cable

Measure distance between Master Station and each Sub-Station, then order equivalent to the total footage of these distances.

Super Selective System

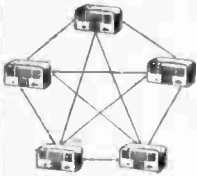

Fig. II

An unusually versatile, low-cost intercommunication system offering complete privacy of conversation and flexibility to meet any requirement in industry, offices, institutions, etc. Consists entirely of Master Station units so that several separate two way conversations may be carried on simultaneously. Any one Master Station may talk to any other Master Station at will. Masters may call one another regardless of whether station being called has power "On" or not.

How to Estimate Cable

Simply measure distance between Master Units starting from any one Master to the second, to the third, etc., until you reach the last station in the system, then order equivalent to the total footage of these distances.

Combination Master System

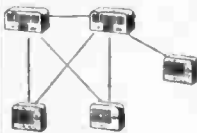

Fig. III

The ultimate in flexibility. This system consists of Master Stations and Sub-Stations in any combination desired. You may start with Two Stations (at least one must be a Master) and add Stations as needed. Master Stations may call any other Master or Sub-Stations. Sub-Stations may answer Master but cannot talk to each other nor can they originate calls to Master Stations. All Masters may have Sub-Stations in common or any Master Station may have individual Sub-Stations.

How to Estimate Cable

Measure cable from Master to Master. Order total of these distances in Master type cable. Measure Sub-Station cable from Sub-Station to nearest Master only

TALK-A-PHONE SPECIAL DELUXE

Far Reaching Power—person called at Sub-Station can answer at distances of 40 ft. from the unit. Either Master Stations and Sub-Stations may be operated at distances of up to 2500 feet from each other. Economy is stressed in the operation. Master Stations can be operated for as little as 15c per month in Electric Current. Master Station Units are housed in attractive walnut wood cabinets measuring 9 $\frac{3}{4}$ " wide x 6" deep x 6 $\frac{3}{4}$ " high. Shpg. wt., 8 lbs. Sub-Stations have durable Metal Cabinets 5 $\frac{1}{4}$ " x 3 $\frac{3}{4}$ " x 7". Shpg. wt. 3 lbs. Special DeLuxe Systems operate on 110-115 volts AC or DC.

Master Selective System

See Figure 1

Model KR-505 Special Deluxe Master Handles one to five stations. With tubes and instructions. Shpg. wt. 9 lbs

C20100—Your Cost \$24.95

Model KR-4010—Special Deluxe Master. Handles one to ten stations. Complete with tubes and instructions. Shpg. wt. 9 lbs.

C20101—Your Cost \$29.95

Model RU-433S—Sub-Station. Shpg. wt. 11 lbs.

C20102—Your Cost \$8.25

C16000—Cable for above. Per 10 ft. 52c

Super Selective System

See Figure 2

You may begin with two Masters and add Units up to a total of ten as desired. Thus as many as five complete two-way conversations may be maintained simultaneously.

Model KS-6010—Special DeLuxe Super Selective Unit. Two to ten units may be used. With tubes and instructions.

C20103—Your Cost \$31.50

C16007—Cable for above. Per 10 ft. **Your Cost \$2.00**

Combination System

See Figure 3

The Special DeLuxe Combination Model utilizes either Master Stations or Sub-Stations in any Combination.

Model KC-8050—Special DeLuxe Master Station. Handles one to five stations. With tubes and instructions. **Your Cost \$32.35**

Model UC-821S—Sub-Station unit. **Your Cost \$7.25**

C16012—Cable. The proper cable for inter-connecting KC-8050 Master Stations. Per 10 ft. **Your Cost \$1.70**

C16005—Cable. The proper cable for connecting UC-821S to KC-8050 Master Stations. Per 10 ft. **Your Cost 35c**

TALK-A-PHONE DELUXE SYSTEMS

Super Selective System

See Figure 2

Model KS-60—DeLuxe Super Selective Master Station. From two to ten may be used. Complete with tubes, instructions and junction box. Shpg. wt. 10 lbs.

C20110—Your Cost \$34.95

Model KS-60-C—With Privacy Earphone. **C20111—Your Cost \$43.50**

C16007—Cable for connecting stations. Per 10 ft. **Your Cost \$2.00**

Combination Systems

See Figure 3

Model KC-80—DeLuxe Combination Master for ten Station use. With tubes, instructions and junction box. **Your Cost \$38.25**

Model KC-80-C—With Privacy Earphone. **C20113—Your Cost \$46.95**

Model UC-82. Sub-Station Unit for above in wood cabinet. **C20114—Your Cost \$11.25**

Model UC-82M—Same as above but in metal cabinet. **C20115—Your Cost \$11.25**

C16009—Cable. The proper cable for inter-connecting to KC-80 and KC-80-C Masters. Per 10 ft. **Your Cost \$3.50**

C16005—Cable. The proper cable for connecting UC-82 and UC-82M Sub Stations to KC-80 or KC-80-C Master Stations. Per 10 ft. **Your Cost 35c**

Master Selective Systems

See Figure 1

Model KR-40—DeLuxe Master Station, for use with up to ten Sub-Stations. With tubes, instructions and junction box. Shpg. wt. 10 lbs.

C20106—Your Cost \$34.95

Model KR-40-C—With Privacy Earphone. **C20107—Your Cost \$43.50**

Model RU-43—DeLuxe wood Sub-Station. Shpg. wt. 4 lbs. **C20108—Your Cost \$11.25**

Model RU-43M—DeLuxe metal Sub-Station. **C20109—Your Cost \$11.25**

C16000—Cable for connecting Sub Station to either type Master. Per 10 ft. **Your Cost 52c**

All DeLuxe Systems shown on this page are available in Underwriters Listed Models at small additional cost.

Pushbutton Operated Models also available. Write for quotations on your specifications.

SEMI-DIRECTIONAL MICROPHONES

CONTACT

ELECTRO-VOICE

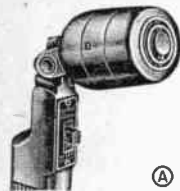

(A) Model 630. Moving coil dynamic, Acoustalloy diaphragm. High quality reproduction of speech and music, indoors and outdoors. Flat frequency response from 40-9000 cps. Output -53 db. Tilting head for directional or non-directional use. Built-in cable connector and switch. Complete with 20 ft. cable. Shpg. wt. 5 lbs. Hi-impedance. **\$21.46**
C13505—Your Cost



(B) Model 605. Dynamic for general sound work, paging, call, dispatch systems, recording and communications. Flat frequency response from 50-7500 cps. Output -57 db. Acoustalloy diaphragm. Head at fixed tilt of 22°. Satin chrome finish. Complete with 8 ft. cable and connectors. Hi-impedance. Shpg. wt. 5 lbs. **\$14.41**
C13785—Your Cost
C13784—Your Cost. With 20 ft. cable. **\$15.29**

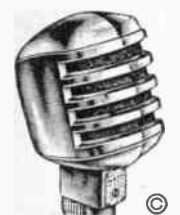

(B) Model 905. Crystal. Same design and characteristics as Model 605, except for -54 db output. High capacity moisture sealed crystal. **\$9.70**
C13723—With 8 ft. cable.
Your Cost
C13724—With 20 ft. cable. Your Cost \$10.58



(C) Model 610. Dynamic. For ham rigs, public address and paging systems. Quality reproduction of voice and music. Acoustalloy diaphragm. Substantially flat frequency response from 50-8000 cps. Output -53 db. For durable service indoors and outdoors. Head at 15° fixed tilt. Satin chrome finish with 8 ft. cable. **\$17.35**
C13725—Your Cost
C13726—With 20 ft. cable. Your Cost \$18.23



(C) Model 910. Crystal, high quality, high capacity moisture sealed crystal. Same design and characteristics as Model 610, except for -48 db output. **\$13.23**
C13727—With 8 ft. cable.
Your Cost
C13728—With 20 ft. cable. Your Cost \$14.11



(D) Model 600-D. Hand-Held Speech Dynamic. Designed for clear, crisp speech transmission in communications, public address, and recording. Extremely rugged for use indoors or out at temperatures from -40° to 185° F. Acoustalloy diaphragm. Frequency response from 100-6000 cps. Output -55 db. Push-to-talk switch operates mike and relay. Panel mounting bracket on rear of case. Equipped with 6 ft. of cable. Black phenolic case. Hi-impedance. **\$20.58**
C13729—Your Cost
C13730—As above with switch lock. \$21.46

SEMI-DIRECTIONAL MICROPHONES

Semi-directional microphones are pressure microphones that respond to variations in sound pressure. They include Crystal, Dynamic, Carbon and Condenser generating elements. These are substantially non-directional although they tend to become directional at the higher frequencies. For a microphone of 2 1/8" diameter, directivity starts at about 2000 c.p.s. and increases with frequency.

Pressure microphones are excellent all-purpose instruments where conditions of room reverberation, acoustic feedback and ambient noise are not too severe. The better quality types are desirable for broadcast announcing and remote pick-up, public address, amateur communication and recording. Recommended for outdoor as well as indoor work.

SHURE

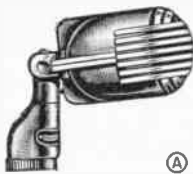

(A) Model 708-A. Stratoliner for good reproduction of voice and music. Genuine Bimorph crystal. Frequency response 60-8000 cps. free from undesirable peaks. High output of -53 db. Tilting head for directional or non-directional use. Pearl Gray finish. With 7 ft. cable. Hi-impedance. **\$12.35**
C13633—Your Cost
C13634—With 20 ft. cable. Output -56 db. Your Cost \$13.23



(B) Model 707-A. Mechanically isolated moisture proofed Bimorph crystal. For amateur phone transmitters, public address and call systems. Frequency response suitable for voice and music reproduction. Output -53 db. Pearl Gray finish. Hi-impedance. With 7 ft. cable. **\$7.94**
C13630—Your Cost
C13430—With 20 ft. cable. Output -56.5 db. Your Cost \$8.82



Model 52 "Econodyne" sturdy dynamic microphone that offers quality performance at low cost. Frequency response from 60-8000 cps. Output -52 db. With 15 ft. cable. Hi-impedance. Similar in appearance to Model 707-A. **\$11.76**
C13631—Your Cost

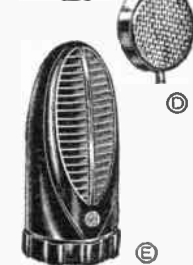

(C) Model 51 Sonodyne. Pressure dynamic microphone. For general purpose use. Operates on principle of moving coil element in magnetic field. Peakfree response 60-10,000 cps. Switch on front of case for output of 56.1 db at 40 ohms, -56.8 db at 250 ohms, or -55 db at Hi-impedance. Rich Pearl Gray finish. With 20 ft. cable and connectors. Shpg. wt. 5 lbs. **\$18.23**
C13432—Your Cost

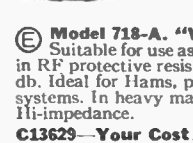

(D) Model 76-B. Lapel Mike. Designed for public address, lecturing, and portable transmitters for intelligible speech reproduction. Pressure-actuated diaphragm type crystal microphone. Frequency response 40-6000 cps. Output -57 db. With lapel clip, 25 ft. of cable. Dia. 1 1/8". Hi-impedance. **\$15.88**
C13638—Your Cost



(E) Model 718-A. "Versatex". Diaphragm type sealed crystal mike. Suitable for use as hand mike, on floor stand or as desk stand. Built-in RF protective resistor. Frequency response 60-8000 cps. Output -53 db. Ideal for Hams, paging systems, home recording, and low cost P.A. systems. In heavy maroon shock resisting plastic case. With 7 ft. cable Hi-impedance. **\$5.88**
C13629—Your Cost

CONTACT MICROPHONES



AMPERITE KONTAK MIKES

For All Musical Instruments

Faithfully Reproduce the Vibrations of any Musical Instrument. Reproduce the entire audible range without introducing any annoying peaks. Used extensively by many famous name bands. Increase timbre—create new effects. Available, as illustrated with (B) or without (A) hand volume control. For use on regular mike channels of any high-impedance input amplifier having 60 db. or higher gain. Moisture-proof rubber cases may be attached to any musical instrument. Average shpg. wt. 4 lbs. each.

(A) Without Volume Control (1x3x1") **Your Cost \$7.06**
 Stock No. Model Range Level Cable
C13675 SKH 40-6000 c.p.s. -40 db. 15-ft.

(B) With Volume Control (3x1x3/4") **Your Cost \$10.58**
C13690 KKH 40-6000 c.p.s. -30 db. 25-ft.
C13687—Strap for flat top guitars. Your Cost \$5.9c

"KF" Foot Volume Control

(C) Provides smooth control of volume by foot action. For any high impedance Kontak mike. Size: 9x2 1/2x2 1/2". Supplied with 15-ft. cable. Shpg. wt. 4 lbs. **\$10.58**
C13663—Your Cost

LGP Input Transformer

(D) Matches 50 or 200 ohms to hi-impedance input. Standard for close talking microphones; Laboratory for voice and music. **\$4.70**
C13608—Standard—Your Cost
C13609—Laboratory—Your Cost \$5.88

TURNER Contact Mike

Model MM Provides amplified volume from any stringed instrument without feed back. Volume control built in. 3 1/4"x1 1/4".
Model MM, complete with 20-ft. cable. \$10.58
C13757—Your Cost
C13758—Without Volume Control. \$9.26
Your Cost

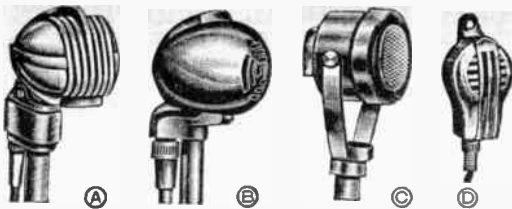

SEMI-DIRECTIONAL MICROPHONES ACCESSORIES

TURNER MICROPHONES

A Model 33D Dynamic. For amateur work, recording, and orchestra pickup. 90° tilting head for semi- or non-directional use. Specially designed aluminum diaphragm, quality Alnico magnet. Frequency response 30-9000 cps. Output -54 db. Satin chrome finish. With 20 ft. cable and connectors. Hi-impedance.
C13752—Your Cost.....\$15.88

A Model 33X Crystal. Shock mounted, moisture sealed, Rochelle salt crystal, barometric compensator. Design and other characteristics same as model 33D except -52 db output.
C13753—Your Cost.....\$14.41

B Challenger Models. Inexpensive, practical microphones for general purpose work. For inexpensive public address, and paging systems, amateur rigs, home recorders. Crystal models, have shock mounted, moisture sealed Rochelle salt crystals, barometric compensators and wind gap to prevent blasting. Dynamic has specially designed aluminum diaphragms. All with 7-ft. cable, and are hi-impedance.
Model CD Dynamic. Frequency response 50-7000 cps. Output -52 db. Satin chrome finish.
C13763—Your Cost.....\$11.47

Model CX Crystal. Frequency response 50-7000 cps. Output -52 db. Satin chrome finish.
C13765—Your Cost.....\$9.55

Model BX Crystal. Frequency response 50-6000 cps. Output -52 db. Attractive Brown enamel finish.
C13764—Your Cost.....\$6.38

C Model U9S. Professional type dynamic. For remote broadcast, recording, amateurs. Adjustable saddle tilts 90° for semi- or non-directional pickup. Specially designed aluminum diaphragm. Frequency response 40-9000 cps. Output -52 db. Baked gun metal finish. With 20 feet cable and connectors. Hi-impedance.
C13754—Your Cost.....\$23.52

D Hand-D Crystal or Dynamic. For stage work, amateur, and call systems. Can be mounted on floor or desk stand, has suspension hook for hanging. Slide contact on-off switch. With 7 ft. cable and connectors. Satin chrome finish. Hi-impedance.
Model 3D Dynamic. Frequency response 60-7000 cps. Output -52 db.
C13760—Your Cost.....\$15.88

Model 9X Crystal. Frequency response 0-7000 cps. Output -52 db.
C13759—Your Cost.....\$13.82

E Model 22D Dynamic. For amateurs, call and paging systems, general use indoors and outdoors. Ninety degree tilting head permits semi- or non-directional operation. Quality Alnico magnet. Frequency response 50-9000 cps. Output -54 db. Satin chrome finish. With 7 ft. cable and connectors. Hi-impedance.
C13751—Your Cost.....\$14.99

E Model 22X Crystal. High quality, humidity protected crystal. Mechanical shock proof mounting. Equipped with automatic barometric compensator. Same design and characteristics as model 22 D except output of -52 db.
C13750—Your Cost.....\$11.76

F Model 20X Crystal. New lightweight, low cost hand mike for home recorders, amateurs and paging systems. Shock mounted "Metalseal" Rochelle salt crystal. Barometric compensator. Frequency response 50-7000 cps. Output -54 db. Rich Brown enamel finish. With 7 ft. cable. Hi-impedance.
C13768—Your Cost.....\$7.56
C13769—As above with switch.....\$8.73

ASTATIC

G Model T-3 new improved crystal, superb response for amateur rigs, recording, and P.A. Tilting head for semi- or non-directional use. Output -52 db. Chrome plated finish. With cable, spring cable protector, and connector. Hi-impedance. Shpg. wt. 3 lbs.
C13676—Your Cost.....\$16.08

Model GT-3. Model T-3 microphone with Grip-To-Talk stand. Shpg. wt. 5 lbs.
C13525—Your Cost.....\$19.32

H Model JT-30. Inexpensive. All-purpose crystal microphone. Especially suited for amateur, home recording, and portable sound systems. Frequency response from 30-10,000 cps. Output is .52 db. Mounted on combination hand and desk stand, with heavy die cast interlocking base. Finished in Opalescent Gray and Bright Chrome grille. Complete with concentric cable connector, and 15 ft. of cable. Hi-impedance. Shpg. wt. 4 lbs.
C13427—Your Cost.....\$9.97

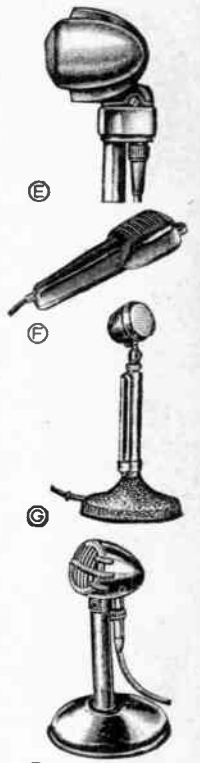

MICROPHONE ACCESSORIES



J Speco "Max-Mixer" Mike Input Mixer for adding and mixing two or more mikes than provided by regular input of amplifier. 3 individually controlled hi-imp. inputs. With 6-ft. cable, mike connector, and phone plug adaptor.
C13642—Your Cost.....\$11.14

K Mike Dust Cover keeps dust, grit, moisture from working parts. Permits use of sensitive mikes in windy areas by elimination of wind howl. Reproduction is 95% true with cover in place.
C13450—Your Cost.....\$9¢

L Carbon Granules extra fine quality, guaranteed non-adulterated. Sufficient for refilling one two-button carbon mike.
C13481—Your Cost.....29¢

M Mike Springs of finetempered steel. Dia. 1/4" x 1 1/2" long. Set of 8 springs.
C13462—Your Cost.....17¢



N O Mike Base Flanges and Extension Rods widely used for neat inconspicuous permanent mounting on desk top, pulpit, speaker stands, amateur rigs and telephone switchboards. Fits all standard 3/8" 27 mike mounts. Available in male or female types. Base dia. 1 1/4", 3 mounting holes with 3/8" mounting centers. Extension rods male on both ends.
C13350—Male Flange. Your Cost.....30c
C13351—Female Flange. Your Cost.....30c
C13352—6' Extension Rod. Your Cost.....44c
C13353—12' Extension Rod. Your Cost.....59c

P Shure A83A Switch can be quickly attached to any cable-connector type Shure microphone. Bakelite arrow knob. No wiring required for installation.
C13594—Your Cost.....\$2.56

R Mike Cable Clip made of nickel plated brass. Used for holding mike cable close to microphone stand.
C1161—Your Cost.....9¢



S Shure Input Transformer high quality cable type. For use where long lengths of mike cable are required, without loss of high frequencies. Matches 40 and 250 ohm mikes to hi-imp. input. 1 1/8" dia. x 2 1/8". With 7 ft. cable.
C13673—Your Cost.....\$7.70

T Desk or Floor Stand Clutch. Improved clutch action barrel, threaded to fit standard 3/8"-27 male threaded tubing 3" long. Merely remove old clutch arrangement and screw latest device to outer tubing for adjustment.
C13355—Your Cost.....\$2.06

Mike Adapters, for adapting special mike fittings to standard stands.
C13367—Your Cost.....44c
 3/8" 27 female to 1/2" male pipe thr. (RCA).
C13368—Your Cost.....29c
 1/2" female pipe to 3/8"-27 male.
C13369—Your Cost.....15c
 3/4" long 3/8"-27 male running thr.
C13370—Your Cost.....29c
 3/8"-27 female to 3/8"-27 female coupling.
C13370—Your Cost.....29c

UNI-DIRECTIONAL

MICROPHONES

BI-DIRECTIONAL

ELECTRO-VOICE



(A) CARDYNE. Eliminates unwanted sounds, reduces background noise, stops feedback, increases working distance from microphone. New Mechanophase principle gives wide angle front pickup over wide frequency range, dead at rear. New Acoustalloy diaphragm insures wide flat response. Will withstand extremely severe operating conditions for both outdoor and indoor use in remote broadcasting, disc, and film recording, and public address. Substantially flat response from 40-10,000 cps. Output -53 db. Alnico V magnet. Satin chromium finish. Standard mike stand threads. Built-in on-off switch. Complete with 20 ft. cable, plugs. Hi-impedance.
C13718—
Your Cost \$34.99



(B) Cardax. Moisture sealed crystal element. Cardioid microphone with new Mechanophase principle provides true cardioid unidirectional pickup and relatively high gain. Dual frequency response. Selector switch varies response for hi-fidelity sound pickup or extra crispness of speech. Output -57 db on flat curve, -48 db on rising curve. Compact rugged construction for indoor and outdoor use in public address, recording and communications. Tilting head. Built-in on-off switch. Satin chromium finish. Complete with 20 ft. cable and plugs. Hi-impedance.
C13720—
Your Cost \$23.23



(C) Pressure Gradient Dynamic. Ellipsoid pickup pattern. 40-11,000 cps. -56 db. Satin chromium finish. Built-in on-off switch.
C13610—PGH High impedance
C13613—PGL 200 ohms
Your Cost, Either \$18.82
C13611—PGAH. As above, but 70-8000 cps, 12-foot cable. High-impedance.
Your Cost \$14.70
(C) 13607—Plastic Baffle for PG microphones.
Your Cost Each \$8c

AMPERITE

BI-DIRECTIONAL MICROPHONES

In the usual form this type is known as Velocity or Ribbon. They respond to the difference in pressure on the front and back of a thin ribbon suspended in a magnetic field. They are bi-directional for all frequencies. Live at the front and back and dead at the sides, top and bottom. They can be worked from the front or back or both simultaneously. Pickup from the front or back decreases as the angle of pickup is increased. It is usually considered that an included angle of 90°, both front and rear, is a usable range. The discrimination against

ELECTRO-VOICE



Microphones listed below are similar in that each has high fidelity, bi-directional pickup. Open type, reflection-free housing, internal shock absorber and one piece frame. Both are high impedance.

Model V-1. Velocity ribbon. Excellent for public address, recording, and remote broadcast. May be tilted in its cradle to reduce feedback and random noise, permitting increased volume levels. Built-in shock absorbers to eliminate mechanical vibration. Sliding contact switch shorts transformer secondary in "off" position. Frequency response substantially flat from 40-9000 cps. Output -65 db. Satin chrome finish. Complete with 20 ft. cable and connectors. Shpg. wt., 4 lbs.
C13722—
Your Cost \$21.46

Model V-2. Wide Range Velocity. Rubber mounted shock absorber reduces mechanical vibration. Locking, tilting one piece cradle. Frequency response substantially flat from 40-10,000 cps. Built-in On-Off switch, in "off" position shorts transformer secondary. Output -62 db. Finished in durable Bronze Gun metal. Complete with 20 ft cable and connectors. Shpg. wt. 5 lbs.
C13740—
Your Cost \$26.46

UNIDIRECTIONAL MICROPHONES

Cardioid, meaning "Heart Shaped," is a term applied to unidirectional microphones, describing their pickup pattern. These are excellent all purpose instruments that give wide angle 135° front pick-up and null back response. Lowered room reverberation, random noise and acoustic feedback decreases or eliminates many serious causes of distortion and volume level limitations. Both crystal and dynamic types are available, as well as combination velocity-dynamic.

These microphones, live at the front, dead at the rear, solve many sound and broadcast installation problems. Especially desirable for overcoming feedback and audience noise. Can be used in or out of doors, for music or speech, broadcast, recording, public address, or communications.



(D) Model 737-A. Monoplex high output Super Cardioid. "Metal Seal" crystal, with "Shure Uniphase" principle. For public address, communications, and all types of recording. Frequency response from 60-10,000 cps over wide range angle at front. Rear response down approximately 15 db. Output -53 db. Complete with 20 ft. cable and connectors. Finished in Pearl Gray. High impedance. Swivel head.
C13431—
Your Cost \$17.05



(E) Model 55. Unidyne moving coil dynamic, with new "Shure Uniphase" principle. For public address and recording. Flat response from 40 to 10,000 cps. Impedance selector switch at rear of case to allow selection of Low, Medium or High impedance. Output is -56.1 db into 40 ohms, -56.8 db into 250 ohms, and -55 db into 35,000 ohms. Tilting head adjustment. Complete with 25 ft. of cable and connector plug. Shpg. wt. 7 lbs.
C13689—
Your Cost \$32.34



(F) Model 556 "Broadcast". Super-Cardioid type unidirectional moving coil dynamic microphone. Unidirectional characteristic obtained by "Shure Uniphase" principle. Especially designed and tested to meet the requirements of the broadcast studio. Random noise pickup reduced 73%. Spring suspended in case to reduce mechanical vibration pickup. Frequency response from 40 to 10,000 cps. Switch at rear of case for selection of Low, Medium or High impedance. Output -56.1 db at 40 ohms, -56.8 db at 250 ohms and 55 db at 35,000 ohms. Tilting head adjustment. Complete with 7 ft. cable, and connectors. Shpg. wt. 6 lbs.
C13562—
Your Cost \$49.98

SHURE

sound at the sides reduces random noise pick-up, acoustic feedback and room reverberation by a ratio of nearly 2:1 over semi- or non-directional microphones. This almost doubles working distances.

Velocity microphones characteristically have excellent bass response and are ideal for orchestra or solo pickup. Unwanted sounds may be minimized by orientating microphone so that its side faces the sound source.

AMPERITE

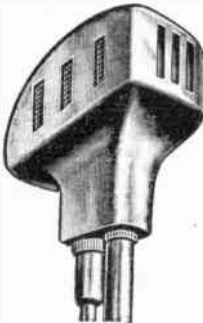

Studio Ribbon Microphone, for broadcasting, recording, and public address. Will not become "boomy" on close talking. Pickup angle 120° at front and back with practically no frequency discrimination. Ruggedly constructed for indoor or outdoor use. Not affected by wind. Frequency response from 40-14,000 cps. Output -56 db. Chrome finish. Complete with switch, 25 ft. cable and connectors. Shpg. wt. 8 lbs.
C13616—R80 H. Hi-impedance.
C13617—R80 L. 200 ohm
Your Cost Each \$47.04

Model RBHG Ribbon. Frequency response from 50-11,000 cps. Output -65 db. Chrome finish. Complete with switch, 25 ft. cable and cable connectors. Shpg. wt. 8 lbs.
C13620—RBHG Hi-impedance.
C13621—RBLG 200 ohms.
Your Cost Each \$24.70

Model RSHG Ribbon, for public address, and recording. Frequency response from 70-8,000 cps. Output -60 db Baked enamel finish. Complete with switch, 12 ft. cable and cable connector. Shpg. wt. 8 lbs.
C13623—RSHG Hi-impedance.
C13624—RSLG 200 ohms.
Your Cost Each \$18.82

MICROPHONE ACCESSORIES

HIGH FIDELITY REPRODUCERS

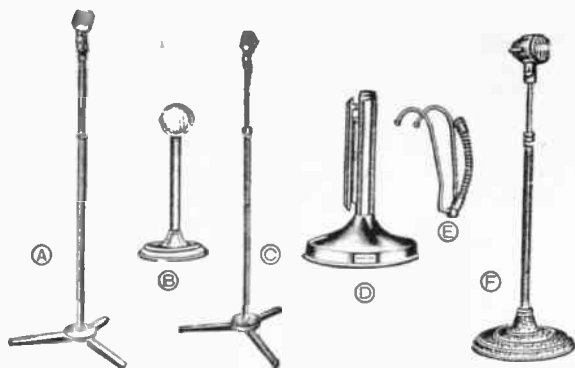

ELECTRO-VOICE

- (A) Model 425 Floor Stand.** One hand finger tip operation. Press button to raise or lower shaft between 37" and 66" automatically locks when button is released. New type adjustable 3 legs base with 17" spread gives firm support. Two legs adjustable, for placing flush against speakers stand, or stage. Folds up for portability. Modern streamline design, rich satin chrome finish. Standard $\frac{3}{8}$ "-27 thr. Shpg. wt. 9 lbs. **C22049—Your Cost.....\$14.41**
- (C) Model 430 Floor Stand.** Press button with finger, raise or lower with other hand, between 36" to 65", automatically locks. Three legged base with 17" spread. Two legs adjustable for flush mounting against stage. Legs removable to make compact package. Attractive gray finish, extension shaft finished in satin chrome. Shpg. wt. 9 lbs. **C22048—Your Cost.....\$8.82**
- (B) Model 423-A6 Desk Stand.** Sturdy desk or table stand. Round die cast base, rubber buttons prevent scratching surfaces. Finished in satin chrome. Base dia. 4 $\frac{3}{8}$ ", stem riser 6". Shpg. wt. 1 lb. **C13538—Your Cost.....\$2.35**

ASTATIC

- (D) Grip-to-Talk Desk Stand.** Built-in micro-movement switch operates relay for "break-in" operation. Ideal for use with Ham rigs, paging and call systems. Fits 3-prong Astatic mikes. Telephone black base, chrome plated tube 8 $\frac{1}{4}$ " high. **C13373—Your Cost.....\$6.44**

CONCORD

- (F) Quality Floor Stand.** Smooth, adjustments, from 35" to 68". Positive grip friction clutch firmly locks stand. Base dia. 10", finished in black wrinkle, chrome plated uprights. Shpg. wt. 19 lbs. **C22047—Your Cost.....\$4.69**
- (E) Lecturers Neckstand.** For lecturers, demonstrators, and teachers, fits comfortably around neck leaving hands free. Flexible gooseneck has $\frac{3}{4}$ "-27 thr. Weighs only 12 oz. **C13451—Your Cost.....\$1.95**

ATLAS MICROPHONE ACCESSORIES



- (A) Boom Stand.** For suspending mike over speakers' table, or stage. Adjustable to weight of any mike. Height from 48" to 72". Boom arm 63" long, can be easily removed. Base dia. 17". chrome and gun metal finish. Chrome plated uprights. Shpg. wt. 35 lbs. **C22059—Your Cost.....\$32.34**
- (B) Baby Boom Arm.** Quickly attaches to floor stand. Universal swivel for adjusting and locking in position. Adjustable for weight of any mike. Length 32". **C22060—Your Cost.....\$4.12**
- (C) Bracket Clamp.** Can be used directly as mike support, or with baby boom arm. Can be clamped to overhanging edge of a table, desk, or piano. Chrome finish. Length 6". **C13371—Your Cost.....\$1.76**
- (D) Flexible Gooseneck.** Attached to any mike stand. Used where moderate adjustment required. Male and female ends have $\frac{3}{8}$ "-27 thr. Chrome finish. Length 13". **C13372—Your Cost.....\$1.18**

TRUE-SONIC Co-Spiral Speaker

(A) P52FR—Revolutionary new speaker design. High electro-acoustic transfer efficiency and wide range achieved with only one voice coil and with no cross-over network. Reproducing range is 40 to 16,000 cycles.

Full 15 watts of power-handling capacity. Uses two acoustic sections, one of which is a 15" seamless molded curvilinear cone of new design for reproducing lowest bass; the other section, for extended high tones, is a mathematically designed acoustic spiral which gives 90 degrees of high-frequency dispersion. This brand new and patented method of high-frequency propagation is the differential diffuser called the SILVER SPIRAL.

Input impedance is 16 ohms. Overall diameter is 15 $\frac{3}{4}$ ". Net weight 23 lbs, including a 40 oz. Alnico 5 magnet. **C21314—Your Cost.....\$47.04**

DeLuxe Reflex Cabinets

(B) 52D—Superb cabinet, distinctively modern, designed to harmonize with quality furnishings. Rare woods finished by master craftsmen. Port opening, hidden by grill cloth, engineered to Bass-Reflex design equations for balanced low-frequency response. Drums, tubes, lowest voice tones reproduced with startling realism. For 15" speakers such as Tru-Sonic P52 series and others. Solid construction, lined with acoustic material. No false resonance. 24" x 17 $\frac{1}{2}$ " x 35". Shpg. wt. 75 lbs. **C21318—Mahogany—Your Cost, Either.....\$76.44**

Coaxial Speaker

(C) P-52A—Frequency response 30-16,000 cps, \pm 5db 50-12,000 cps. "Room presence" living, vital realism. An assembly of 4 units: 15" bass speaker; high-freq. speaker with small precision-built diaphragm; 8-cell horn unit; and 1200 cps cross-over network that divides highs from lows and channels each to the proper speaker. Eliminates acoustic cross-modulation. Pains-taking tests before large selected and discriminating audiences have developed perfect balance and blend throughout the entire audible spectrum. Rugged, precise construction plus Alnico 5 magnets totaling 96 oz. give this speaker the idelity and efficiency needed for ideal FM reception, broadcast station monitoring, sound motion picture reproduction and laboratory uses. Power input: 20 watts. Input impedance: 16 ohms. Hi-freq. horizontal distribution 80 degrees; vertical distribution 40 degrees. Size 15 $\frac{1}{4}$ " dia. overall, 10" deep. Wt. 30 lbs. **C21315—Your Cost.....\$120.54**

Coaxial Unit in Cabinet

(D) Consists of Model P52A coaxial speaker described above mounted in same cabinet as described below. Cabinet sturdily constructed of heavy, rigid, vibration-proof plywood and lined with moisture-resistant material to eliminate spurious resonance. Carefully designed release port beneath cone relieves back-pressure and reinforces frontal wave. Attractive, conservative modern design with beautiful glossy Battleship-grey finish. Size: 26x15x34" high. **C21316—Your Cost.....\$155.82**

Separate 2-Way Speaker System

(E) P-5211F—Differs from P-52A system in that completely separate low and high frequency units are employed. Separation of these units and mounting low frequency unit in Model 52U base reflex cabinet (described above) and high frequency unit on top of cabinet, makes maximum efficiency possible from each speaker. Since space is no longer a major factor, a larger multicellular horn (11x9 $\frac{1}{2}$ x15 $\frac{1}{2}$ ") is used and a lower and more effective crossover frequency is selected. Separate field units are provided for each speaker. These heavily powered units provide perfect balance and performance from deepest bass to highest overtones, without emphasizing some frequencies or leaving out others. The feeling of "Presence" and the true meaning of "High-Fidelity" are realized in this superb instrument. Characteristics: power input 20 watts; input impedance 16 ohms; crossover frequency 800 cycles; frequency response 30-16,000 cps; \pm 5 db 40-12,000 cps; distribution, horizontal 80 degrees, vertical 40 degrees; combined field weights 6 lbs. Alnico 5 permanent magnet. Size: cabinet 26x15x34" high, overall height 43". Net wt. 90 lbs. Shpg. wt. 130 lbs. **C21317—Your Cost.....\$188.16**

Jensen Quality SPEAKERS

JENSEN Type "J" Coaxial Hi-Fi Speakers

(A) Efficient dual speaker assemblies with cone type "tweeter" mounted in the cone assembly of the "woofer." Ideal for FM and fine for AM receivers, for broadcast and recording monitoring, etc. The 15" models incorporate a built-in two channel network providing high and low-pass channels with attenuation of 10-20 db per octave; also furnished with four-position High Frequency Control Switch on a 36" cable ("roll-off" control of high range). 12" model has simple bridging type network that affords good wide-range performance; no range control switch with this model. These units can be used with enclosures below.

Model JAP-60. 15-inch Speaker

Professional type. Range 50 to 12000-15000 c.p.s. Efficiency 3 db higher than other 15" models. Input impedance 500 ohms. Max. input 14-15 watts. Integral two-channel network. With 4-position H.F. control. Shpg. wt. 24 lbs. **\$55.53**
C19007—Your Cost.

Model JHP-52. 15-inch Speaker

For all general applications. Range 50 to 12000-15000 c.p.s. Maximum input 12-14 watts. Input impedance 500 ohms. Integral 2-channel network. 4-position H.F. control. Shpg. wt. 23 lbs. **\$47.04**
C19002—Your Cost.

Model JCP-40. 12-inch Speaker

Replaces 12" speakers in radios and phono-radio combinations. Range 50 to 10000-12000 c.p.s. Max. input 8-10 watts. Input impedance 6 ohms. Has simplified bridging type network (no H.F. control). Shpg. wt. 16 lbs. **\$19.60**
C19008—Your Cost.

H.F. Level Control

Simplified fidelity control for Model JCP-40 Coaxial speakers. Easily connected. Gives desired high frequency response. Can also be used as 16 ohms, 15 watts level control. Shpg. wt. 2 lbs. **\$1.96**
C9010—Your Cost.

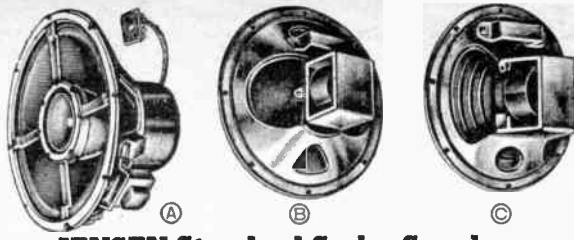

JENSEN Standard Series Speakers

A complete line of replacements for radio receivers, low power public address systems and intercommunication equipment. Highly efficient Alnico 5 magnets insure unlimited life. Hum bucking coils built into field coil models. All models less transformers. A complete listing of output transformers will be found below. P4-X through P8-U 3-4 ohm V.C. P8-S through P12-T 6-8 ohm V.C. All Dynamics 3-4 ohms V.C.

(B) P. M. Speakers

Stock No.	Model	Size	Watts	Output trans.	Your Cost
C18960	P 4-X	4"	2.0	E	\$2.44
C18952	P 5-X*	5"	2.5	E	2.91
C18968	P 5-X	5"	2.5	E	2.53
C18969	P 6-W	6"	3.5	E	3.32
C18970	P 8-U	8"	6.0	D	4.91
C19076	P 8-S†	8"	8.0	C	7.50
C18971	P10-T	10"	8.0	C	6.26
C18972	P12-T	12"	9.0	C	6.97

*Voice coil impedance 40-50 ohms.
†Extra heavy magnet.

(C) Field Coil Speakers

Stock No.	Model	Size	Watts	Field Ohms	Output trans.	Your Cost
C18953	F 4-X	4"	2	2800	E	\$3.18
C18956	F 4-X	4"	2	450	E	3.03
C18954	F 5-X	5"	2 $\frac{1}{2}$	2800	E	3.35
C18955	F 5-X	5"	2 $\frac{1}{2}$	1800*	E	3.29
C18958	F 5-X	5"	2 $\frac{1}{2}$	450	E	3.15
C18961	F 6-X	6"	3	2800	E	3.41
C18981	F 6-X	6"	3	1800*	E	3.47
C18983	F 8-W	8"	4	2500	D	4.00
C18959	F 8-W	8"	4	1800*	D	3.97
C18984	F 8-W	8"	4	1000	D	3.91
C18985	F10-S	10"	9	2500	†	7.64
C18962	F10-S	10"	9	1500	†	7.47
C18987	F12-S	12"	10	2500	†	8.73
C18963	F12-S	12"	10	1500	†	8.58

†Fixed impedance output transformers recommended.
*Tapped at 300 ohms.

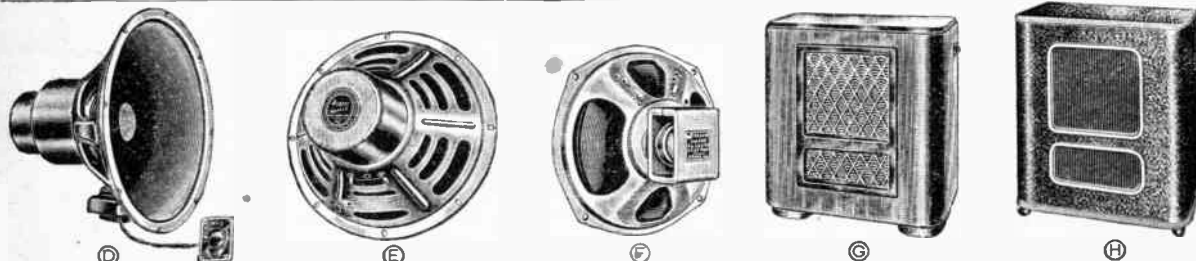

JENSEN Model HNP-51 Coaxial Speaker

(D) Model HNP-51 with compression type H-F speaker and L-F cone type speaker in a coaxial unitary assembly with integral dividing network mounted on the speaker frame. An H.F. range control switch is attached to the dividing network by a 36" cable. H-F "roll off" at 15,000, 10,000, 7,500 and 6,000 c.p.s. H-F speaker is mounted behind L-F unit and fed through the field by means of a trumpet. L-F cone voice coil is built around this trumpet. (Input impedance 500 ohms; power rating 25 watts. L-F speaker 15" curvilinear cone; Alnico "V" PM fields. Size: 15 $\frac{1}{8}$ " dia. x 10 $\frac{1}{8}$ " deep. Shpg. wt. 18 $\frac{1}{2}$ lbs. **\$81.66**
C19003—Your Cost.

JENSEN PM Concert Speakers

(E) Use in all types of radios, phonographs, public address equipment and the Jensen Bass Reflex enclosures and cabinets, at right. All models less output transformer listed. Transformers listed at right.

Stock No.	Model	Size	Watts	V.C.	Output trans.	Shpg. Wt.	Your Cost
C19075	P 8-R	8"	9	6-8	C	4 lbs.	\$ 8.97
C19073	P10-R	10"	10	6-8	B	5 lbs.	10.88
C19077	P12-R	12"	12	6-8	B	7 lbs.	11.47
C19071	P12-Q	12"	13	8	A	9 lbs.	16.32
C19069	P12-N	12"	15	8	A	16 lbs.	28.81
C19078	P15-Q	15"	14	8	B	15 lbs.	21.76

JENSEN Extended Range Speakers

(F) ALNICO 5 PM speakers providing high fidelity performance up to 10,000 c.p.s. designed for monitoring in broadcast stations for replacement and modernizing units for F.M. and television receivers for radio-phono combinations, etc. Less output transformers.

Stock No.	Model	Size	Watts	V.C.	Output trans.	Shpg. Wt.	Your Cost
C18948	P 8-SH	8"	7.5	6-8	C	4 lbs.	\$ 8.35
C19000	P12-SH	12"	9	6-8	B	5 lbs.	10.58
C18999	P15-NH	15"	16	8	A	10 lbs.	33.66

JENSEN "D" Bass Reflex Enclosures

(G) Constructed of genuine striped walnut. Excellent for Jensen coaxial speakers, or for high-fidelity radio, phono or P.A. systems. Model D121: For 12" speakers. Size: 27 $\frac{1}{8}$ "x31 $\frac{1}{8}$ "x13 $\frac{1}{8}$ ". Shpg. wt. 50 lbs. **\$49.00**
C18945—Your Cost.
Model D151: For 15" speakers. Size: 27 $\frac{1}{8}$ "x31 $\frac{1}{8}$ "x13 $\frac{1}{8}$ ". Wt. 47 lbs. **\$49.00**
C18946—Your Cost.

Model "B" Bass Reflex Enclosures

(H) Durable but inexpensive. Designed for smooth H.F. response, maximum extension of L.F. response. Made of impregnated composition board finished in hammered brown lacquer. Removable feet for wall mounting. For Dimensions Wt. Your Cost

No.	Speakers	H.	W.	D.	Lbs.	Your Cost
C18994	8"	24	x18	x9 $\frac{1}{2}$ "	19	\$16.33
C18996	12"	27	x24 $\frac{1}{2}$	x13 $\frac{1}{2}$ "	31	25.48
C18998	15"	32 $\frac{1}{2}$	x27 $\frac{1}{2}$	x13 $\frac{1}{2}$ "	50	31.68

JENSEN Universal Output Transformers

Universal tube transformers match V.C. to 4500, 7000, 10,000 and 14,000 ohms. Universal line transformers match V.C. to 500, 1000, 1500 and 2000 ohm lines.

No.	JENSEN	Application	Core	Term.	Type	Your Cost
C19026	ZX-1007*	Univ. Tube	1x 1"	Pintip	A	\$5.73
C19027	ZY-2005	Univ. Line	1x 1"	Pintip	A	5.73
C19025	ZX-1005*	Univ. Tube	$\frac{1}{2}$ x $\frac{1}{2}$ "	Pintip	B	4.23
C19024	ZY-2003	Univ. Line	$\frac{1}{2}$ x $\frac{1}{2}$ "	Pintip	B	4.23
C18965	ZX-1002*	Univ. Tube	$\frac{1}{2}$ x $\frac{1}{2}$ "	Pintip	C	2.94
C18964	ZY-2002	Univ. Line	$\frac{1}{2}$ x $\frac{1}{2}$ "	Pintip	C	2.94
C19028	ZY-4002	Univ. Line	$\frac{1}{2}$ x $\frac{1}{2}$ "	Pintip	D	1.97
C19029	ZP-1023	Univ. Tube	$\frac{1}{2}$ x $\frac{1}{2}$ "	Solder lug	E	1.26
C19030	ZL-2021	Univ. Line	$\frac{1}{2}$ x $\frac{1}{2}$ "	Solder lug	E	1.26
C19031	ZP-1024*	Univ. Tube	$\frac{1}{2}$ x $\frac{1}{2}$ "	Solder lug	D	1.53

*All primary windings center tapped.

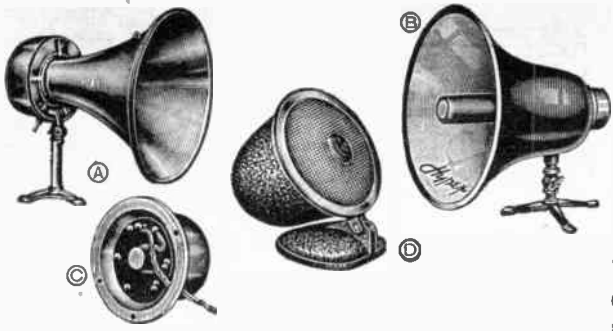

Jensen UNIVERSITY SPEAKERS

JENSEN Peri-Dynamic Projector

(A) Projectors are complete assemblies of PM speaker and acoustic system. Usually good frequency response from 100 to 5500 cycles. For music or voice reproduction. Suitable for indoor or outdoor use. Power handling capacity 15 watts average, 25 watts max. Voice coil impedance 8 ohms. Bell dia. 24 1/2" depth, 30". Shpg. wt. 20 lbs. **C19004**—Less stand. **Your Cost \$48.51**
C19005—JENSEN EA-5 adjustable stand for projector above. **Your Cost \$2.94**

JENSEN Hypex Projectors

(B) Especially suitable for speech reproduction and commercially acceptable music reproduction. Sturdy steel encased unit, plus reflex horn construction insures dependable operation under all-weather conditions. Finished in durable baked two-tone gray lacquer. Increased efficiency in the region above acoustic cut-off.
 Type H1-20. Horn only. Bell diam. 20 1/2". Depth 16 1/2". Acoustical length, 4 ft. Nominal acoustic cut-off, 165 cps. Stand coupling flange tapped for 3/4" pipe thread. Shpg. wt. 18 1/4 lbs. **C18926**—Your Cost **\$16.46**
 Type H24. Horn only. bell dia., 24 1/2". Depth, 20 1/2". Acoustical length, 5 ft. Nominal acoustic cut-off, 140 cps. Shpg. wt. 21 3/4 lbs. **C18927**—Your Cost **\$21.05**

JENSEN Type "U" Annular Driver Units

(C) U-20. PM type. Rate at 15 W. average, 25 W. max. Normal voice or music input. 16 ohm V.C. Diam. 5 1/4". Depth 3 3/4". Wt. 11 lbs. **C18919**—Your Cost **\$24.11**
 Fixed Impedance Transformers, encased in metal cans; will not mount directly on speaker.
C18922—500 to 16 ohms. Core size, 1/4 x 1/4" Each **\$ 4.26**
C18923—500 to 8 or 16 ohms. 1 1/4 x 1 1/4" Each **11.93**

Stands and Supports

Adjustable Stand. Sturdy cast fitting with three-leg base, for mounting projector on wall or other surface. Horizontal and vertical adjustment. **C18924**—Your Cost **\$1.76**
 Adjustable Support. Provides adjustment when projector is mounted on pipe mast. 3/4" pipe thread on both ends. **C18925**—Your Cost **\$1.18**

JENSEN "Speech-Master"

(D) AP-10: Desk type PM speaker employs Peri-Dynamic principle. For desk or wall mtg. Has "tilt" adjustment and sturdy base. Dustproof, fully enclosed. Internal bracket for 1 1/2 x 1 1/2" transformer. Ht. 6 1/2"; dia. 5"; d. 5". With 36" cord. Gray finish, satin chrome trim. 4 ohm voice coil. Wt. 6 lbs. **C18929**—Each **\$8.17**
 AP-11: As above, less base and swivel bracket. Mounts in 4 7/8" cutout. Wt. 4 lbs. **C18930**—Each **\$6.64**

Speaker Accessories

Kainer Deluxe All-Steel Projector

(K) Constructed of heavy spun steel alloy and will accommodate all types of 12" speakers with or without transformers. Rear housing has back pressure release. Overall length, 20"; bell, 17"; flare extension, 11". Screened breather opening. Finished in baked art metal grey. Fixture (welded to baffle) is tapped to fit standard 1/2" pipe. Base has a tilting dog-toothed adjustment, with swivel and lock nut. Shpg. wt. 13 lbs. **C20077**—J-12 (less base). **Your Cost \$10.53**
C20078—Bracket with base only. **Your Cost \$1.76**
C20087—Waterproof cover. **Your Cost 1.03**

Car-Top Horn Carrier

(L) Waterproof plywood and angle iron construction. 4 suction cups and gutter hooks with adjustable straps. 8x 46 1/2". Shpg. wt. 8 lbs. **C20028**—Your Cost **\$4.63**

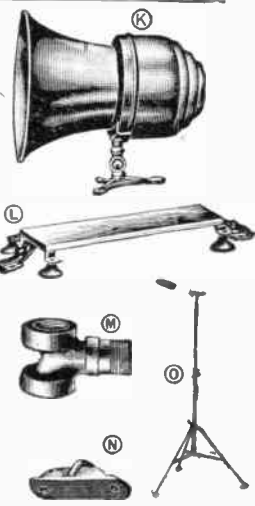

UNIVERSITY Reflex Projectors

(E) High efficiency exponential air column type projectors. Heavy-gauge all metal spun horns. Compact and easy to install. Incorporate design features that insure superior acoustic results. Non-resonant rubber rims with each unit. Will handle 25 watts output. Complete with universal "U" type mounting bracket. Finished in hattleship grey. Waterproof for outdoor use. Less drivers.

Stock No.	Model	Bell Dia.	Lgth.	C.P.S. Cutoff	Shpg. Wt.	Your Cost
C20049	PH	20"	16"	140	10 lbs.	\$17.05
C20047	LH	25"	21"	115	15 lbs.	26.17
C20046	SMH	15"	12"	180	6 lbs.	14.41

UNIVERSITY Driver Units

(F) Built to the most exacting standards of precision engineering. All employ quality Alnico magnets to insure peak efficiency. New one-piece molded Phenolic diaphragm, immune to extreme temperature changes and corrosion. Units use the exclusive University "rim centering" construction for perfect alignment, and greater efficiency. Alignment not affected by shock or vibration. Entire assembly in hermetically sealed housing. Standard thread fits all standard projectors. Model MAH has VC impedance of 8 ohms. Models SAH and PAH have VC impedance of 16 ohms.

Stock No.	Model	Range	Cap. Wt.	Sh. Wt.	Your Cost
C21300	MAH	100-6000	12 2 1/4"	2 1/2"	\$14.70
C21301	SAH	90-6000	25 5"	5"	21.76
C21302*	PAH	80-6000	25 9"	9"	31.16

UNIVERSITY Industrial Paging Speakers

(G) Compact intercommunicator "booster" speaker having extremely high projecting power. Clear sound output overcomes factory noises. Can be used as "Talk Back" speakers in intercom systems. High sensitivity permits initiating or answering calls at a distance from the speakers. For industrial plants, terminal yards, docks and loading platforms. Complete with adjustable mounting bracket.

Stock No.	Mod.	Cap. Wt.	V.C. Freq.	Resp. Wt.	Shpg. Lbs.	Your Cost
C19349	MIL	5	8	400-9000	3 1/2"	\$14.70
C19348	IB8	12	8	300-6000	5"	19.99
C24015	CR	18	16	250-6000	9"	24.70

UNIVERSITY 360° Radial Projectors

(H) "Infinite Baffle" sealed acoustic chamber is responsible for the added base response afforded; cone is properly loaded. Give uniform coverage in all horizontal directions (360°). Easily mounted; single point suspension. Projection angle is about 15° down for most effective sound placement. Other features: All-Metal weatherproof construction; "rubber tire" rims; "floating rubber" cone mounting; back pressure "breathers."

No.	Model	Cone	Diam.	Height	Weight	Each
C24016	RBP8	8"	18"	9"	9 lbs.	\$11.52
C24017	RBP12	12"	27"	11"	19 lbs.	20.58

UNIVERSITY Radial Speaker

(J) Model IBR reflex air column horn with radial deflectors and built-in hermetically sealed driver. Particularly recommended as "Talk Back" speakers for intercom systems. High sensitivity eliminates close talking, calls can be initiated or answered at a distance from speaker. For paging and call systems in factories, warehouses or outdoor locations where 360° coverage is required. Frequency coverage 300-6000 cycles. Power capacity 12 watts. Impedance 8 ohms. Bell dia. 9", height 11". Shpg. wt. 5 lbs. **C19347**—Your Cost **\$22.93**

UNIVERSITY Accessories

(M) **C21305**—Model 2YC Connector for connecting two-driver units to any trumpet. **Your Cost \$5.88**
 (N) **C21306**—Model PMA Adaptor for mounting trumpet on pipe fitting. **Your Cost .88c**
 (O) **C21304**—Model TS-10 Stand for University Trumpets. **Your Cost \$23.52**

Line Matching Transformers weatherproofed for outdoor use.

No.	Type No.	Primary Imp.	Sec. Imp.	Watts	Cost
C5898	5401	500-1000-1500-2000	8	12	\$ 7.35
C5899	5402	250-500-1000-1500-2000	4-8-16	25	11.76



CONCORD SPEAKERS And BAFFLES



CONCORD Walnut Baffle
 (A) Here is something ultra-new in quality speaker baffles. Sturdily built framework of heavy seven-ply veneer plywood paneled with a handsomely cut one-quarter plywood front panel. Two grooves on both sides of baffle give extended back-wave when mounted flush against walls or panels. Measures: 14 1/4" wide, 16 1/4" high, 8 3/4" deep at top and 5 3/4" deep at bottom. **\$5.25**
C20051—Each
Lots of 2—Each **\$4.95**

Dual Speaker Case
 (B) Houses two speakers up to 12" in diam. Opens into two halves, each serving as an efficient baffle. Sturdy plywood with strong handle, black leatherette covering. Metal bumpers top and bottom. Plated snap lock fasteners (two each side). Size, closed, 9x14 1/4x22 1/4". Shpg. wt. 13 lbs. **\$6.45**
C22062—Your Cost

Single speaker case similar to above. Size 14x14 1/4x9 1/4". Shpg. wt. 13 lbs. **\$4.15**
C22061—Your Cost

CONCORD Walnut Baffles
 (C) Efficient enclosed speaker baffles with correctly angled front faces to provide coverage over a wide area. Sturdily built of selected wood. Brown leatherette covered. Average shpg. wt. 6 lbs.

No.	Speaker	H. W. D.	Each
C20060	6"	8 3/4 x 7 1/2 x 4 3/4	\$1.59
C20042	8"	10 1/2 x 9 x 6 1/2	1.90
C20055	10"	14 x 12 x 8 1/2	2.95
C20056	12"	15 x 14 x 10	3.75

Walnut Paging Baffle
 (D) A beautifully polished walnut baffle for deluxe paging systems. For any standard 8" PM speaker. Frieze grille cloth. 11" high, 10" wide, 6 1/2" deep at top and 3 1/4" deep at bottom. Shpg. wt. 6 lbs. **\$3.15**
C21326—Your Cost

UNIVERSAL Line and Tube Transformers
 (E) For use with Concord and other speakers. Match voice coil to any tube, single or push-pull, universal line transformers match voice coil to 500, 1000, 1500 or 2000-ohm line. Average shipping weight each 2 lbs.

Wattage	Univ. Line	Univ. Tube	Each
18	C19190	C19194	\$1.52
24	C19191	C19195	1.85

Output Transformer—5-Watt

No.	Impedance	For Tubes
C1964	2,000 ohms	25B6, 25L6, etc.
C1965	5,000 ohms	25A6, 43, etc.
C1967	10,000 ohms	41, 6C6G, 6A4-LA

Your Cost Each, Any Type **\$5.95**

Universal Tube to VC Transformers

C1954—4 Watt for up to 6" speakers..... **\$0.87**
 C1955—8 Watt for up to 10" speakers..... **.97**
 C1956—18 Watt for 10" to 12" speakers..... **1.30**



GE Public Address Speakers

Newly designed Alnico V P. M. speakers incorporate the latest engineering developments in scientific tone reproduction. Each is given a severe electrical test for assurance of longer life. Each is checked acoustically in a sound-proof booth. Recommended for use with public address systems and for replacement in home radios. **C19351 is the 25-watt speaker used in all Concord public address systems.** Aluminum base voice coils provide higher wattage output and will not warp. Molded cones assure high fidelity and brilliant frequency response. Plated finish protected by new Lusteron treatment. Assembled with universal transformer mounting brackets.

Stock No.	Dia.	Alnico V Magnet Wt.	V.C. Imp.	Wattage	Shpg. Wt.	Your Cost
C19350	12"	6.8	8	12	7	\$10.00
C19351	12"	9	8	25	8	12.05



CONCORD Dynamic Speakers

A quality line of speakers for general replacement purposes. Speakers are also recommended for use with intercommunications systems, light public address work, radios and record players.



Can also be used as replacement for automobile radios. When properly baffled, Concord speakers have a substantially flat frequency response from 100 to 4500 cps. All use high quality permanent magnets and formed one-piece cones.

Stock No.	Dia. Inches	Field Ohms	Normal Watts	Shpg. Wt.	Your Cost
C19279	3	450	2	3	\$1.68
C19265	3	2750	2	3	1.78
C19115	4	450	2 1/2	3	2.49
C19261	5	6 volt†	2 1/2	3	2.39
C19262	5	450	2 1/2	3	2.39
C19263	5	3000	2 1/2	3	2.43
C19264	5	1800*	2 1/2	3	2.92
C19117	6	6 volt†	3 1/2	4	2.92
C19118	6	1000	3 1/2	4	3.03
C19119	6	1800*	3 1/2	4	3.63
C19120	6	2500	3 1/2	4	3.63
C19121	8	1000	4	6	5.83
C19124	8	1800*	4	6	5.83
C19292	8	2500	4	6	5.83
C19125	10	1000	8	7	5.83
C19285	10	2500	8	7	6.97
C19126	12	1000	12	9	6.97
C19127	12	2500	12	9	6.97

* Tapped at 300 ohms † 6V Auto



CONCORD PM Speakers

High quality permanent magnet speakers. Each matches in sensitivity a comparable field coil type. High permeability Alnico V and Alnico III magnets used for utmost efficiency. One-piece seamless cones, plated metal frames. Voice coil impedance 3.2 ohms up to 8" size, 6-8 ohms above 8". All supplied less output transformer.

Stock No.	Dia. Inches	Watts nor.	Watts plk.	Depth	Shpg. Wt.	Your Cost
C19155	2	1	2	1 1/2	1	\$1.75
C19268	3	2.5	4	2 1/2	2	1.75
C19269	5	3	4.5	2 1/2	3	1.89
C19270	6	4	6	2 1/2	3	2.35
C19271	8	5	8	3 1/2	4	3.70
C19290	10	8	10	6 1/2	6	5.65
C19272	12	9	12	6 1/2	7	6.45
C19258	4x6	3	4.5	2 1/2	1	1.89



QUAM Alnico V PM Speakers

Utilizes the new Alnico V magnet—recent development providing maximum performance with minimum weight. Widely used for AC-DC radios, record-players, inter-office and auto receivers. High conversion factor. 3.2 ohm V.C. Less Trans. 4" sq., 5" and 6" round.



Stock No.	Dia.	Wattage Nor.-Peak	Alnico V Magnet Wt.	Depth In.	Shpg. Wt. Lbs.	Your Cost
C19310	4"	2 1/2	3 3/4 .68 oz.	2 1/2	1 3/4	\$2.35
C19312	4"	2 1/2	3 3/4 1.47 oz.	2 1/2	1	2.76
C19313	5"	3	4 1/2 .68 oz.	2 1/2	1 1/4	2.47
C19315	5"	3	4 1/2 1.47 oz.	2 1/2	1 1/4	2.85
C19316	6"	4	6 1.00 oz.	2 3/8	1 1/2	2.82
C19318	6"	5	7 1/2 2.15 oz.	2 3/8	1 1/2	3.44
C19319	8"	6	8 2.15 oz.	3 1/4	2	4.23
C19320	8"	10	12 4.64 oz.	3 3/4	4 1/4	6.00
C19321	10"	9	11 3.16 oz.	4 1/2	4 1/2	6.17
C19322	12"	12	15 4.64 oz.	5 1/4	5	7.44
C19323	12"	15	20 6.80 oz.	5 3/8	5 1/2	8.53

QUAM Electro-Dynamic Speakers

Designed and constructed for use as radio replacements. All conform to RMA standard dimensions and are equipped with the Quam Ad-justa-A-Cone voice coil suspension. Field coils are manufactured from carefully selected and tested materials, guaranteeing long life under adverse climatic conditions.

Stock No.	Dia.	Field Ohms	Wattage Non	Wattage Peak	Depth Inches	Shpg. Wt.	Your Cost
C19327	4"	450	2.5	3.75	2	1 3/4	\$2.59
C19328	4"	2700	2.5	3.75	2	1 3/4	2.70
C19329	5"	6-V	2.5	3.75	2 1/8	2	2.70
C19330	5"	450	2.5	3.75	2 1/8	2	2.70
C19331	5"	1000	2.5	3.75	2 1/8	2	2.70
C19332	5"	1800	2.5	3.75	2 1/8	2	2.70
C19333	5"	6-V	2.5	3.75	2 1/8	2 1/2	3.18
C19334	6"	1000	3.5	5	2 1/2	2 1/2	3.18
C19335	6"	1800	3.5	5	2 1/2	2 1/2	3.18



QUAM 4x6 Oval Speakers

Available in both dynamic and PM types, these highly efficient R M A Standard 4x6 speakers are for general replacement purposes. Depth 2 1/4", 3.2 ohm V.C. Less Transformer.

Alnico V Your Cost 450-ohm Field Your Cost
C19300—Each **\$2.62** | **C19303—Each** **\$3.12**

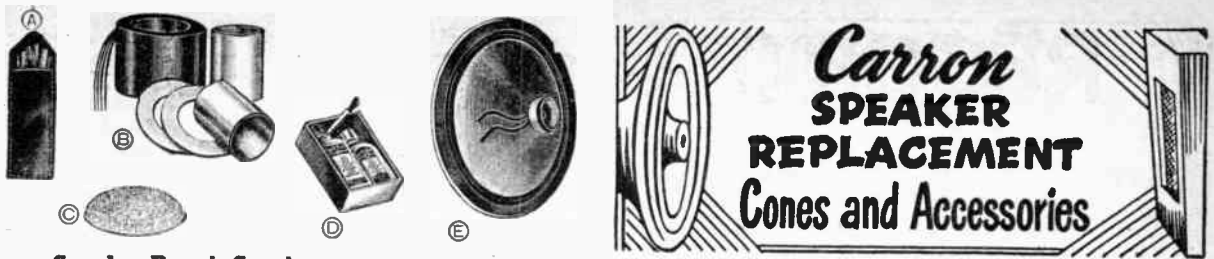

Carron SPEAKER REPLACEMENT Cones and Accessories

Speaker Repair Service
Speakers reconditioned with Carron seamless cones. Install new voice coil and align. Dust and other causes of noisy reproduction removed. P.M.'s remagnetized. Delivery approx. 30 days. Approx. costs are:

4"-6".....	\$1.55
7"-9".....	2.55
10"-12".....	3.05
13"-over.....	3.85

Cones not in Carron listing can be sent in for duplication. Approx. costs are:

4"-6".....	\$1.00
7"-9".....	1.70
10"-12".....	2.20
13"-over.....	3.00

Speaker Shims

(A) Non-Magnetic Monel shims. 4 each .004", .006", .008", .010" shims. In plastic case with pencil clip.
C19649—Your Cost..... 24¢

Universal Field Coils

(B) Fits 5" and 6" speakers. Spacing washers, tubes and directions with coil. Size: Type A 2"ODx $\frac{1}{2}$ "-1" long, hole $\frac{1}{8}$ "-1". Type B 1 $\frac{1}{2}$ "ODx $\frac{1}{2}$ "- $\frac{3}{4}$ " long, hole $\frac{1}{8}$ "- $\frac{1}{2}$ ".
Type A Your Cost Ohms Type B Your Cost

C19461	450	C19481	
C19456	1000	C19477	
C19457	1500	C19478	
C19458	2000	C19482	
C19459	2500	C19479	
C19460	3000	C19480	

\$1.09 **73¢**

WALSCO Speaker Cone Patches
Specially fabricated material and adhesive for permanent cone repair. 12 assorted patches.
C19647—Your Cost..... 24¢

WALSCO Flocked Grille Screening

Protective grille for radio, intercom phonograph speakers. Will not tear, split or fray.
Stock No. Size Color Your Cost

C19487	8x11"	Brown	\$0.32
C19489	18x24"	Brown	1.12

Speaker Grille Cloth

Handsome frieze, 50" wide, cut to your specified length.
C20949—1 $\frac{1}{2}$ Yard. Your Cost..... \$1.85
C19496. 12x12". Your Cost..... 25¢

Voice Coil Dust Felts

(C) Felt discs used on voice coils to keep dust out. Can be glued to any cone. Package of 25.
C14745—Your Cost..... 24¢

Cement Kit

(D) An efficient cement kit for speaker cones, voice coils, r.f. coils and chokes. One bottle of all-purpose cement, one bottle of thinner, and brush.
C19499—Your Cost..... 44¢

CARRON EXACT DUPLICATE REPLACEMENT SPEAKER CONES

(E) Seamless one-piece cones that duplicate the original units. Feature enduring, non-resonant quality. Voice coils are accurately wound and firmly attached to cones and are also exact duplicates of the originals. Only Popular numbers are listed below; we can supply on order any round or oval cone not shown below—give make and model of receiver, or send in your old cone with voice coil and spider attached.

Stock No.	Carron No.	Model No.	Stock No.	Carron No.	Model No.
4" Speaker Cones					
C19563	1562	Emerson AX211, 4X5-324	C19520	1642	Utah 12PG17A, 12J43-B
C19606	1564	Emerson CT1275, 6J5, 368U	C19521	1664	Utah G-12-P, 12PH15-C
C19366	1553	Gen. Elec. H508	C19522	1483	Utah GT13, F12P
C19372	1555	Oxford (Fada 105-134B, RCA 9TX3)	Your Cost, Each..... \$1.87		
C19369	1616	Utah 4A106A	12" Speaker Cones—Continued		
C19370	1619	Zenith 49AG385	C19534	1542	TI-4 (Pt. No. 36-1469)
C19371	1620	Zenith 49U334	C19538	1587	TP4, TP12, PT25
Your Cost, Each..... 65¢			Your Cost, Each..... 59¢		
5" Speaker Cones					
C19411	1417	Airline 62-475, Arvin 18	C19682	1244	54, 57 (Pt. No. 36-3029)
C19441	1626	Chevrolet 985538(Sprk. 41045)	C19552	1203	5, 5T (Auto) (Pt. No. 02861)
C19445	1373	Crosley 516	C19703	1343	FT9 (Ford) 816 (Pt. No. 36-3526)
C19446	1589	Crosley 719E, C-648-A	Your Cost, Each..... 65¢		
C19543	1489	Emerson A130, A132, A148, 149	6" Speaker Cones		
C19462	1584	Emerson D-L-330	C19549	1500	F1608 (Chrysler)
C19578	1043	Jensen T3 (Crosley 175, 343)	C19550	1455	F1540 (Ford), (Pt. No. 45-2608)
C19463	1507	Jensen PM5DS, H5S	Your Cost, Each..... 65¢		
C19466	1387	(Quam-Nichols (Air King 260)	7" Speaker Cones		
Your Cost, Each..... 81¢			C19516	1557	1708, F194D
6" Speaker Cones					
C19576	1285	Jensen F6R (Belmont 777)	Your Cost, Each..... 71¢		
C19470	1400	Jensen PM6C, G6R	9" Speaker Cones		
Your Cost, Each..... 97¢			C19681	1246	34B, L (Pt. No. 36-3157)
7" Speaker Cones					
C19474	1583	Chevrolet 985-536	C19671	1245	6, 7, 8, 9, 10 (Pt. No. 36-3159)
Your Cost, Each..... \$1.29			Your Cost, Each..... 65¢		
C19504	1617	Zenith 49AB341	8" Speaker Cones		
Your Cost, Each..... \$1.14			C19547	1079	20, 21 (Pt. No. 02625)
8" Speaker Cones					
C19612	1411	Jensen G8R, PM8C	Your Cost..... 81¢		
C19506	1200	Magnavox 154D, 48C, 158	10" Speaker Cones		
C19485	1548	Jensen PM8DS, PM8GS	C19529	1248	16B, 14LZX (Pt. No. 02625)
Your Cost, Each..... \$1.46			C19400	1078	87, 40, 41, 65 (Pt. No. 36-3170)
10" Speaker Cones					
C19501	1000	Atwater-Kent No. 15142, 55	Your Cost, Each..... 90¢		
C19532	1060	Majestic G3, 90, 91, 101	12" Speaker Cones		
Your Cost, Each..... \$1.46			C19551	1539	39-40, 39-45 (Pt. No. 36-4089)
12" Speaker Cones					
C19510	1035	Jensen D7, D8 (11 $\frac{1}{4}$ ")	Your Cost..... \$1.46		
C19701	1384	Jensen PM12C	For RCA Sets		
C19613	1474	Jensen PM12B	5" Speaker Cones		
C19533	1062	Majestic G5, 131, 132	C19554	1091	M34, M105 (Pt. No. 9023)
C19641	1366	Jensen A12	Your Cost, Each..... 65¢		
C19588	1315	Rola G12	9" Speaker Cones		
Your Cost, Each..... \$1.14			C19405	1124	R32, 52, RE45, E35 (Pt. No. 10801)
Your Cost..... \$1.14			Your Cost..... \$1.14		

CABINET REPAIR ACCESSORIES



Shellac Patch Sticks

(A) For repairing cabinets. All are 7" long; in various shades.
C15523—Light Walnut. C15525—Black.
C15524—Dark Walnut. C15526—Maple.
Your Cost, Each..... 29¢

Plastic Cabinet Cement

Repairs Bakelite or Plaskon molded radio cabinets. Dries fast and holds securely.
2-oz. bottle.
C15273—Your Cost..... 35¢

GENERAL Scratch Stik

(B) Handy pocket stick for servicemen, removes scratches from radio cabinets in a jiffy. Contains filler and scratch polish.
C15520—Your Cost, Each..... 21¢
10 For..... \$1.89

Scratch Remover Kit

(C) Combination kit of 6 colors, popular shade of wood Scratch-Stik fillers and 2 bottles scratch remover liquid—walnut and clear. Works on all types of light and dark wood.
C15530—Your Cost..... 59¢

Cabinet Repair Kits

(D) Handy kit, ideal for radio shops, stores, trucks, etc. Small brushes in caps of all bottles make quick patching of damaged cabinets easy. Kit contains bottle each of: Ivory spirit enamel, light and dark, dark brown lacquer enamel, walnut spirit stain, polish renewer, French varnish; 3 sheets garnet finishing paper, steel wool, polishing cloth and instructions. Shpg. wt. 3 lbs.
C15527—Your Cost..... \$1.56

(E) For use on plastic, bakelite or wood cabinets. 9 shades of shellac sticks, bottles of light and dark oil stain, bottle of metal shading lacquer. Magic Scratch Remover, alcohol lamp, spatula, touch-up brushes, steel wool, etc. Very easy to use. Shpg. wt. 3 lbs.
C15521—Your Cost..... \$2.65
Cabinet Touch-Up Kit. Same as above, less Scratch Remover, shellac sticks, lamp and spatula (stains only) Wt. 2 lbs.
C15522—Your Cost..... 50¢

RECORD CHANGERS

CRESCENT Automatic Record Changer

A new improved single post changer with the features you would hardly expect to find in the low price field. Simple, single control, plays ten 12" or twelve 10" records automatically. Rejects any record desired, or permits optional playing of records manually. Only three moving parts while changing. Fast... changes records in 5 seconds. "Childproof"—tone arm may be moved at any time without damage. Has self-starting, 78 RPM, 110 volt 60 cycle AC, heavy duty motor, and 9" turntable covered in velvet flox. Will operate satisfactorily on any record regardless of age. Complete with 30' lead wires, and plugs, and simple instructions, for easy connecting. Finished in two-tone brown with attractive plastic trim. Will decorate any radio. Requires only 5 1/4" head room and fits any cabinet with 12 1/2" x 16 1/4" changer area. Shipping weight 12 lbs.



C22503—Your Cost..... \$15.95

GENERAL INSTRUMENT Record Changer

Foolproof mechanism, designed to give the maximum convenience and pleasure with a minimum of attention and care. Will play manually and automatically change up to 10 twelve-inch or 12 ten-inch records. Fast change-over time assures a short wait between records. Discs last longer due to the feather weight pickup used—only 1 1/4 oz. needle pressure. Heavy duty dependable motor of 78 RPM is cushion mounted for silent operation. Records drop on velvet brown flox turntable. Requires a mounting base 11"x12". Overall height 6 1/4" above the mounting plate and 2" below. For use on 115 volts AC, 60 cycle. Complete with mounting hardware. Shipping weight 11 lbs.



C22556—Your Cost..... \$16.95

WEBSTER Record Changer

Simple in design and operation, it provides manual or automatic playing of ten standard 12" or twelve 10" discs with a minimum of waiting time between records. Home recordings or "inside out" records up to 12" size may be played manually. Shuts off automatically after the last record has played. Lightweight pickup less needle has a 36" lead. The unit has a 110 volt, 4 pole, heavy duty, 60 cycle motor. Supplied complete with mounting template, instruction manual, and all mounting hardware for standard 5/8" board. Dimensions: 14"x14"x9" overall. Shpg. wt. 17 lbs.



C22500—Model 56—Your Cost..... \$26.66

New Junior Model similar to above but last record is repeated instead of automatic stop. Dimensions 12 3/4"x12"x9" overall. Allow additional 1/2" front, side and rear for 12" record clearance. Shpg. wt. 15 lbs.

C22501—Model 50—Your Cost..... \$21.17

WEBSTER Intermix Changer

The Model 70 changer is handsomely styled to harmonize with fine furniture; operating mechanism is attractively concealed. Simple to operate and easy to load and unload. All parts are sturdy and of precision manufacture, assuring years of dependable enjoyment. Rim drive type, with rubber-tired idler wheel that is in contact with the drive rim and sleeve only when the changer is in operation, thus eliminating thump caused by flats forming on the idler wheel during long periods of non-use. Removable spindle for easy unloading of played records. Plays 1 1/2" stack of 10" and 12" records intermixed, or full stack of either. Base size: 14"x14", height above main plate 8" when fully loaded, depth below plate 2 1/2". Shpg. wt. 18 lbs.



C22504—Model 70—Your Cost..... \$42.34



AUTOMATIC RECORD CHANGER

- ★LIGHTWEIGHT
- ★SMALL SIZE
- ★NO GEARS
- ★1 1/4 oz. NEEDLE PRESSURE

This changer is a simple, gearless, foolproof mechanism, designed to give the maximum convenience and pleasure with a minimum of attention and care. This machine will play and automatically change a series of up to twelve 10-inch records or ten 12-inch records of the 78 r.p.m. type having an eccentric stopping groove. Recordings sold today for home use are of this type. Very old records that do not have an eccentric stopping groove can be played semi-automatically by operating the reject lever at the conclusion of each selection. The free floating tone arm incorporated in this machine employs a crystal pickup of the hi-fidelity type. Needle pressure 1 1/4 oz. Conventional removable needle. Turntable is brown flox coated. Entire unit is finished in beige and brown enamel. Overall size: 10 3/4" by 12 1/4" by 8". Requires 6" above motor board and 2" below motor board. Complete with mounting hardware.

C22560—Your Cost..... \$19.46

Base for above Record Changer

Wood mounting base for use with above record changer. Walnut finish. Mounting holes and clearance cutout already provided. Provides a complete portable unit ready to attach to a radio. Size, 12 3/8" x 11 3/8" x 2 1/4".

C22361—Your Cost..... \$1.95

GARRARD Record Changer

Garrard's new DeLuxe "Mixer" record changer which plays both 10" and 12" records in any assortment, any combination. Record changing is performed simply, efficiently, and silently. 1-ounce high-fidelity crystal pickup, with frequency response from 30 to 8500 c.p.s. The permanent jewel stylus will last for years of normal playing. The motor is silent and sturdy, built to give powerful but regular governed running. Special spring mountings for full floating non-microphonic installation. Overall dimensions with a full 12" record supply are: 15"x13"x5 1/2". Shpg. wt. 21 lbs.

C22550—A.C. Model—100/130 V. 60 cycles..... \$69.50

C22552—As above, but magnetic head..... \$69.50

Less needle..... \$69.50

As above, but with G.E. Variable Reluctance pickup. Requires pre-amplifier..... \$69.50

C22554—Your Cost..... \$69.50

C22551—Universal A.C.—D.C. Crystal pickup. 100/130 V., and 200/250 V., 25/60 cycles. Wt. 30 lbs..... \$89.50

VM Automatic Intermix Changer

The model "400" record changer is an inter-mix model handling ten 12", or twelve 10" or any ten records intermixed. Gives positive intermix action. Automatically shuts off after last record has been played. Quick, quiet record changing cycle is less than 4 sec. Records are gently lowered on spindle step. Uses "Muted Stylus" cartridge. Mounting space required is 13 1/8" wide, 12 1/4" long, and an overall height of 7 3/8".

C22557—1..... \$28.73

Your Cost..... \$28.73

VM Model 401. Combines Model 400 Intermix changer with beautifully styled birch and maple base. Complete with 6 ft. power cord and 4 ft. intermix cord for radio attachment.

C22558—Your Cost..... \$32.75

Record Changer Bases

Sturdily constructed all-steel bases for use with Webster record changer Models 50, 56 and 70. Attractively finished in dark brown wrinkle finish to harmonize with any surroundings. Mounting brackets welded in place for changer. Non-scratch felt feet permit placing on table tops, other polished surfaces. Measure 13 3/4" x 13 3/4" x 4 1/4". Shpg. wt. 5 lbs.

C22355—For Webster Model 50..... \$3.12

C22356—For Webster Model 56..... \$3.44

C22357—For Webster Model 70..... 3.44

WALSCO Standard Test Record

For immediate audible adjustment of record changers. Solves problem of adjusting set-down position of the pick-up and for proper tripping through series of tones at beginning and end of record. Playing time less than 40 seconds. Stroboscope on rim of label indicates 78 rpm at 60 cycles. Highest quality material. Designed to RMA and NAB standards. Precision checked for perfect flatness, concentricity, thickness and correct groove depth.

C21880—10-in. record..... \$0.88

C21882—12-in. record..... \$1.32

C21881—Set of six..... 4.80

C21883—Set of four..... \$4.80

Phono Motors and Accessories

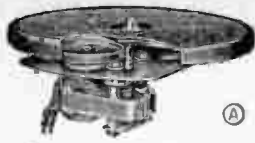

G-I Rim Driven Motor
Model LX. Made by General Industries. Insulation between motor and mounting plate and motor and turntable for quiet operation. Oilless bronze bearings. Twopole speed motor. 9" turntable. 78 r.p.m. 110 V. 60 cycles. Wt. 8 lbs.
C22531—Each.....\$4.08

G-I RM4 Recording Motor
Model RM4. Constant speed (78 r.p.m.) self-starting motor. Weighted 10" turntable. Motor insulated from plate and table. Retractable drive pin. Rim driven; pulley idler and table in one plane. Depth 2 1/16" below plate. 110 volts 60 cycles. Shipping weight 13 lbs.
C22528—Your Cost.....\$9.90

Constant Speed Motor
Model CX. Gear Drive. 78 r.p.m. phono motor for 10" and 12" records. Self-starting induction type. Fully enclosed helical cut gears in oil. Fan cooled. 4 1/2 x 4 1/2 x 3 3/4" deep. For 110 V. 60 cycles. With 10" turntable and all hardware. Wt. 10 lbs.
C22525—Each.....\$8.13

Dual Speed Motors
Model D. Powerful, governor controlled, gear drive motor that will maintain a uniform speed under normal variations in voltage and load. Lever type speed regulator and lever shift to 78 or 33 1/2 RPM. Fully enclosed with silent helical cut gears running in a bath of oil in a sealed housing. 10" turntable. 110 V. 50-60 cycles. Furnished with mounting hardware. Shpg. wt. 13 lbs.
C22530—Your Cost.....\$15.90
C22533—As above with 12" T.T. Your Cost.....\$16.45

Automatic Stop
 For any above motors with 8", 9" or 10" turntable.
C22540—Each.....87c

ALLIANCE Even-Speed Phono-Motor
Model 80. Rim-drive phono motor. 9" turntable. Constant speed (78 r.p.m.) self-starting, forced draft air-cooled. For 10" and 12" records. 110 V. 60 cycles only. Wt. 4 lbs.
C22545—Your Cost.....\$3.75



High Gain Phono Amplifier
Model J. A three tube hi-fidelity amplifier with an additional stage of amplification for use with low output, high quality pickups. Includes volume control and built-in output transformer. Uses new miniature tube types 12AT6, 50B5 and 35W4. Small size of 5 1/2" long, 3 3/4" wide and 3 1/2" high make the unit especially desirable for portable phone players and all applications where space is at a premium. For 110-120 volts, AC or DC. Speaker socket and shielded phono input socket built into chassis—just plug in 5 ft. line cord. Complete with tubes.
C22547—Your Cost.....\$4.95

Phono Oscillator
Model K. Compact new design using series plate modulation. Uses only 2 tubes instead of the usual three tubes. Easy to install and operate. Phono motor and pick-up connect directly to oscillator. Plays records through radio by simply starting record player and tuning in the oscillator on the radio as you do your favorite station. Has tuning adjustment to assure a "clear channel" on your dial. Oscillator is automatically turned off when phono motor is shut off. Permits remote playing of records, and gives high quality reproduction. Complete with tubes.
C22548—Your Cost.....\$5.83

Stroboscopic Speed Checker
Model L. When placed on turntable and illuminated with a bulb (50 or 60 cycle) indicates correct speed at 78 or 33 1/3 r.p.m.
C197—Each.....7c

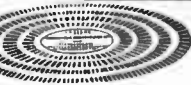

Tone Arm and Head
Model M. Exact replacement for 95% of all non-electronic reproducers in service today. Takes standard replaceable steel, alloy or cactus phono needles. Excellent for construction of children's phonographs. Sturdily constructed of alloy die castings for long years of use. Finished in black and polished nickel. Arm has mounting plate. For up to 12" records. Shpg. wt. 2 lbs.
C13415—Head only.....98c
C13416—Arm only.....\$1.25

ICA Record Player Switch
 Used for quickly connecting record players, F.M. and Television attachments into the audio amplifier of radio receivers. Provides change over from radio to record players without introducing hum. Cuts out radio on phono position.
C12699—Your Cost.....\$1.32

Record Player Cabinet
Model N. Install your own record player or changer in this attractively styled handsomely finished mahogany cabinet. Large enough to house any record player with a base not over 12x12". Will also accommodate a 3 or 4-tube amplifier and a 4" or 5" oval speaker. Constructed of mahogany veneer and selected hardwoods. Finished in reddish-brown mahogany color. Only a limited quantity available—get yours now! Size 15 1/2 x 15 1/2 x 8 1/2". Shpg. wt. 10 lbs.
5B7072—Your Cost.....\$7.95

WEBSTER M-15 Phono Motor
Model M-15. Heavy duty shaded 4 pole motor, improved rim drive, with 9" turntable heavily cushioned with long fibre flock. For manufacture, replacement or home construction of record players. Operates on 105-125 volt 60 cycle. Shpg. wt. 5 lbs.
C22505—Your Cost.....\$3.82

G-I Dual Speed Recorder and Play-Back Unit
Model H. Cuts records up to 10" dia. at 78 or 33 1/2 r.p.m. Plays records up to 12" dia. at 78 or 33 1/2 r.p.m. To shift motor from one speed to another, merely turn the speed change dial. Beautiful walnut wood grain finish on steel base plate. Streamlined plastic trim on pickup and cutter arms attractively engraved with legends "Reproducer" and "Recorder." Convenient depth of cut adjustment. Dynamically balanced rim drive type motor. Compensating switch operated by speed change dial. Assembly includes dual speed motor, 10" weighted turntable, cutting mechanism, crystal pickup, compensating switch, pickup and cutter arm rests, drawn steel base plate. 15" wide, 11 1/2" front to back. 110 V. 60 cycles.
C22516—Your Cost.....\$28.95
 Similar to above, but single speed at 78 r.p.m.
C22517—Your Cost.....\$24.51

G-I Record Changer and Recorder
Model G. Cuts records up to 10" dia. Plays twelve 10" or ten 12" records automatically. Only necessary to lower the cutting arm over the record disc to start the recording operation. Convenient depth of cut adjustment on top of cutting arm. Self-starting, dynamically balanced, recording type motor. Non-jamming record handling fingers which do not extend past record lead-in space. Handles records with either run-in or oscillating trip grooves. Shock mounting provides isolation of entire assembly from the cabinet. Brown iridescent finish. Furnished with crystal pickup. 10" weighted T.T., on-off switch, and spring mounting hardware. Base plate 14"x14".
C22515—Your Cost.....\$40.14



Record Player
 Easily connected to any radio receiver. Beautiful reproduction of favorite records, with full richness of tone. Volume is dependent on radio to which it is connected. Will play records perfectly thru audio section and speaker of largest or smallest receiver in your house. Featherweight, true tracking, crystal pickup will play both 10" and 12" records. Constant speed phono-motor insures accurate reproduction. Single connection to radio or amplifier and speaker is all that's necessary. Attractive sturdily constructed cabinet. Size: 12"x11"x4", for use on 105-125 volt 60 cycle AC only.
C22654—Your Cost.....\$10.95

SHURE Magnetic Recording Head
 (Not Illustrated). High quality, wide response record cutter, for home recording equipment. Standard replacement for thousands of magnetic cutters and with minor circuit changes will replace crystal cutting heads. Designed to operate directly from voice coil winding of output transformer, highly sensitive recording element. Match 4-8 ohm voice coil windings. No mounting brackets. Tapped mounting holes facilitate re-use of brackets on old unit. Size: 2 3/4" x 1 1/2" x 3/4" with needle screw and 4-inch flexible leads. Less stylus. Shpg. wt. 8 oz.
C13799—Your Cost.....\$1.75
 Lots of 6, Each.....\$1.50

PHONO PICK-UPS



ASTATIC Studio Master "400"

(E) Professional type crystal pickup, for broadcast and recording studio use on lateral recordings. Swivel base may be raised or lowered to desired height between 1 3/8" and 2 1/8". Low friction pivots assure constant needle pressure. Low vertical inertia insures ideal tracking even on warped and distorted records. Attractively designed with long, slender curved lines, offset head for low tracking error. Astatic Nylon I-J cartridge with semi-permanent sapphire-tipped replaceable needle. Frequency response from 50 to 8000 cps. Output 1 volt. Needle pressure 1 1/2 oz. Over all length 12 1/4". Finished in light brown Hammerlin.

C13412—Your Cost.....\$14.02

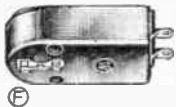

GE Variable Reluctance Cartridge

(F) The latest development in magnetic pickups! Extremely small mass of moving parts, plus outstanding design, gives a frequency response and fidelity limited only by record itself. Like high fidelity, high quality microphones, its output is low. 11 millivolts at 1000 cps. A pre-amplifier is needed between the pickup and phono input. Needle pressure from 3/4 to 1 1/4 oz. is adequate. Reduces hum level; increases record life. Mounts by two No. 3-48 screws on 1/2" ctrs. Size: 1 1/2" x 3/4" x 9/16".

C13464—Your Cost.....\$4.67

GE PRE-AMPLIFIER

(G) A new compact low voltage audio pre-amplifier for use with the G-E Pick-Up. Employs a shock mounted 6SC7 tube in an equalizing circuit. Plate and filament power are obtained from the associated receiver or amplifier. 15' insulated leads furnished. 12' shielded lead and plug for connecting to input of amplifier. Finished in G-E Staybrite Lusteron. Measures 3 3/4" x 3 3/4" x 4 1/2". Shpg. wt. 2 lbs. Complete with tube.

C13465—Your Cost.....\$5.82

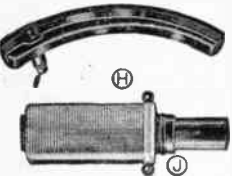

CALTRON Pickup

(H) New high quality phonograph pickup. Incorporates a vibrating reed magnetic cartridge with a needle point pressure of only 1 oz. Especially designed for use where high quality reproduction and long record life are important. Output 2.5 millivolts. Imp. 100 ohms. Shpg. wt. 10 oz.

C13467—Model 300P. Each.....\$8.82

Pre-Amplifier

(J) Model 404. For use with radio and amplifiers having insufficient gain for operation of the Caltron pick-up described above. Delivers 1 volt of undistorted output. Uses 1—6SC7. Shpg. wt. 13 oz.

C13472—Less tube. \$5.88 Each.....

Replacement Cartridge

Model 103P. A vibrating reed magnetic pick-up cartridge in streamlined plastic case. Not affected by weather. Impedance 100 ohms. Output 2.5 millivolts. Shpg. wt. 3 oz.

C13469—Your Cost.....\$5.00

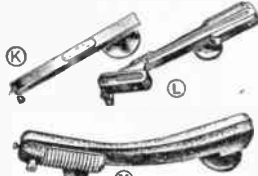

ASTATIC Pickups

(K) Model S-8: Light weight straight arm type with ball-bearing mount. Fine response. For up to 12" records. 8" arm. Shipping weight 3 lbs.

C161—Your Cost.....\$6.56

(L) Model AB-8: Offset-head. Excellent response. Spring axial cushioning. Brown finish. Internally damped crystal. Shpg. wt. 3 lbs.

C119—Your Cost \$6.56

ASTATIC "508" Series

(M) Model Nylon-508 employs the new Nylon I-J crystal cartridge with semi-permanent sapphire tipped replaceable needle. Spring counter balanced to insure correct needle pressure of 1 1/2 oz. Gracefully curved to give moderate offset for low tracking error and balanced side wall pressure. Frequency response from 50 to 8000 cps. Output 1 volt. For 10 and 12 inch records. Finished in light brown Hammerlin.

C13410—Your Cost.....\$10.11

Model 508 employs an L-71 cartridge. Other characteristics same as above.

C13411—Your Cost.....\$9.47



AUDAX Model 73A

(A) Uses the newly developed tuned ribbon reproducer, with replaceable sapphire tipped stylus. For playback of lateral recordings up to 12". Linear frequency response from 50 to 10,000 cycles. Output of -30 db. Impedance 200 ohms. Needle pressure less than 3/4 oz. Finished in bronze and chrome.

C13457—Your Cost.....\$39.10

(A) Model 74A. For lateral recordings up to 18". Other characteristics same as for 73A. Finished in French gray and chrome.

C13459—Your Cost.....\$48.80

Note: Both above available in 500 ohm impedance.

AUDAX Model R-55

(A) Tuned ribbon reproducer for lateral recordings up to 12". Has easily replaceable sapphire tipped stylus. Frequency response is flat within 2 1/2 db. from 50 to 8,000 cycles. Output of -20 db. Needle pressure less than 1 oz. Impedance 200 ohms. Finished in bronze and chrome.

C13460—Your Cost.....\$19.40

Note: Available in other impedances on special order.

BRUSH Crystal Pickup

(D) Eliminates usual needle chuck and set screw. Employs small permanent polished sapphire stylus, bringing the mechanical impedance of the vibratory system to a very low value. Response is flat within ±2 db to 6000 cps., has slightly rising characteristic to 10,000 cps. Will drive conventional two stage amplifier. Taupe and brown finished. 14" overall, for up to 16" records. With equalizer. Shpg. wt. 8 lbs.

C13462—Your Cost.....\$29.40



SHURE "Muted Stylus" Pickup

(N) Muted Stylus crystal pickups play with amazing needle quietness. Has specially designed muted sapphire needle for longer record life. Faithful tracking gives clear, fuller tone qualities, and very low surface noise. Ideal for high quality home phonographs, coin operated machines and similar applications. Needle force is 1 oz. Output voltage 1.8.

C13419—Your Cost.....\$5.88

SHURE "Glider" Pickup

(O) High 1.4 V. output combined with low 1 oz. weight make this one of the finest pickups at its price! Response 60-6000 CPS. Changeable needle. Up to 12" records. Shpg. wt. 8 oz.

C13417—Model 93A. Your Cost..\$3.59

Model 93 AN. Same as above but with quiet sapphire point needle.

C13418—Your Cost.....\$5.06

Tone Equalizer

(P) Recommended for use with all crystal pickups. Four positions: bass, medium, hi-fidelity, and off.

C13475—Your Cost \$1.94

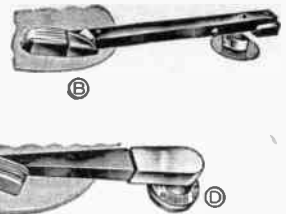

AUDAX Microdyne

(B) Model D-38H—New relaxation principle places resonance of moving system beyond audibility, eliminating harsh peaks. Exciter inertia several hundred times less than in ordinary pickups. Flat within ±2 db to 7500 cycles. Rising bass curve to about 8 db at 50 cycles. Exceptionally low vibratory momentum. Tip pressure about 39 grams. May be used with JEWEL POINT. Black and chrome finish. 12 1/2" long. 500-ohm imp.

C13458—Your Cost.....\$29.25

AUDAX Equalizer Filter

For use with Audax Model R55, 73A and 74A pickups, or any 200 ohms output pickup. Has five positions, covering NAB, Orthostatic, vertical, 78 RPM and filter positions.

C13461—Your Cost.....\$48.80

(C) Replacement head mounting for Model 55 pickup.

C13470—Your Cost.....\$15.99

Replacement head mounting for Model 73A and 74A pickups.

C13471—Your Cost.....\$35.69

Note: Available on special order.

WEBSTER Crystal Pickups

(R) Excellent design and performance. Balanced to track at needle pressure of less than 2 oz. Frequency response from 40 to 8500 cps. For 10" and 12" records. Stamped steel construction brown enamel finish.

C523—Your Cost.....\$2.70

Model AE-10. With natural sapphire tip needle.

C529—Your Cost.....\$2.35

Model AC-10-1. Frequency response from 50-7000 cps. Needle pressure 2 1/2 oz.

C530—Your Cost.....\$1.95

WEBSTER "AJ-1" Crystal Pickup

(S) Precisely balanced pickup with semi-permanent precious-alloy needle. Practically no record wear to needle changing. Streamlined bakelite arm. 40 grams pressure. .5 V. output. Shipping weight 1 lb.

C427—Model AJ-1 \$1.89 Each.....

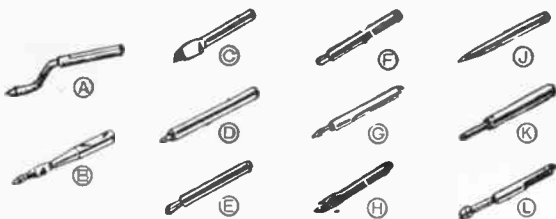

LONG LIFE PLAYBACK NEEDLES

- (A) Precious Metal point needle with offset shank. For maximum record sides without changing. **88¢**
C159—Your Cost Each
- (B) RELIANCE 4000 play needle. Plastic case. Low surface noise. **85¢**
C443—Your Cost Each
- (C) Permo Point 2000 play needle with patented precious metal elliptical point. Standard for coin machines. **50¢**
C164—Your Cost Each
- (D) Reliance Permanent Point Needles, 2000 plays. **39¢**
C165—Your Cost Each
- (E) Fidelitone "Floating Point" needle filters record scratch. 3 to 6 months average use. (1000 or more sides.) Platinum point. Ideal for changers. **50¢**
C227—Your Cost Each
- (D) Deluxe Fidelitone "Floating Point" needle. As above, but good for 5000 plays. **\$1.00**
C478—Your Cost Each
- (J) Transcription metal alloy needle. Long life, high-fidelity. Semi-permanent self-lubricating point. 40 to 50 hours on standard records, longer on home recordings. **69¢**
C286—Your Cost Each
- (L) Sapphire Tipped Playback Needle! Permanent needle—plays 2000 commercial records with minimum wear. Excellent frequency characteristics. A real value. **\$1.15**
C448—Your Cost Each

RCA—Victor "One Grand" Needle

High quality semi-permanent needle. Good for 1000 plays. Minimum wear and surface noise. **50¢**
C479—Your Cost Each

STANDARD PLAYBACK NEEDLES

- (J) Red shank needles for acetate recordings. Individually shadow tested. **46¢**
C433—Package of 100. Your Cost
- (K) Filter point highly polished surgical steel needle. Shadow tested. Low surface noise. 10-15 plays. **8¢**
C209—Package of 10. Your Cost
C222—Package of 25. Your Cost
- (J) High fidelity, shadow tested steel needle. Each good for 10 sides. **21c**
C430A—Package of 10. Your Cost
C430B—Package of 25. Your Cost

JENSEN Royal Jewel Needle

(A) Genuine sapphire jewel point set in specially designed offset shank which reduces surface noise and distortion to a minimum. The hard, smooth, perfectly shaped sapphire point protects your records and provides exceptionally long life for the needle. Plays up to 10,000 sides! **\$1.47**
C111—Your Cost

RUBY-TONE Needle

(B) A precision ground jewel tip that is carefully fused into a specially designed straight shank adapter. This special process practically eliminates surface noise, increases frequency response, and gives perfect reproduction. 3000 plays. **\$1.49**
C192—Your Cost

JEWEL TIPPED Offset-Type Needle

(C) This extraordinary jewel tipped needle will provide a guaranteed 5000 perfect plays. Surface noise and distortion are greatly reduced by an ingenious cushion action design that minimizes record wear and eliminates needle talk. **\$1.07**
C115—Each

Precious Metal Tipped Needle—1000 Plays

Similar in design to above but with a special alloy tip for long life and full clarity. **54¢**
C116—Each Only

KACTI Needles

(D) Long playing cactus needles that produce clear, soft, natural tones. Mechanical surface scratch is practically eliminated. Easy to resharpen. Will not scratch or damage records. **28¢**
C359—Package of 12.
10 Packages for.....\$2.50

PETER GREY Needle Pointer

(E) Famous "Kacti" needle pointer for sharpening cactus needles. Fitted with record brush. **\$1.50**
C293—Shipping weight 2 lbs.
C271—Extra Discs. Each.....15c
10 for.....\$1.35

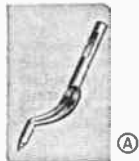

Phono Needles and Accessories

Standard Playback Needles

- (J) RCA steel phonograph needles. **10¢**
C153—Full Tone (Pack of 100) C160—Extra Loud (Pack of 100)
- 10 Packages assorted. 75c. Your Cost per Package.
- (J) RCA Chromium needles. Green shank. **25¢**
C357—Package of 6. Your Cost per Package
- 10 packages. \$1.80
- (J) RELIANCE Chrome plated individually shadowgraphed needles. Good for 15 plays each. **15¢**
C440—Package of 5. Your Cost
- (J) Green shank shadowgraphed needles. Good for 12 plays each. **46¢**
C432—Package of 100. Your Cost
- (K) Hi-fi needles for automatic record changers. Good for 10 to 15 plays each. **21¢**
C146—Package of 25. Your Cost
- (K) RCA Red Seal needles, designed for Red Seal records. C141—Pkg. of 50. **25¢**
10 Packages for.....\$1.87

RECORDING NEEDLES

- (E) Lapped edge sapphire cutting needle for acetate discs. Precision cut jewel for low surface noise and highest fidelity. Over 5 hours cutting life. **\$3.23**
C191—Your Cost Each
- (E) Like above, but with Long Shank to fit Presto Professional and Brush cutting heads. **\$3.45**
C198—Your Cost Each
- (F) Sapphire cutter ground to W.E. spec. For acetate discs. About 10 hours life. Can be resharpened. **\$4.25**
C196—Your Cost Each
- (F) Steel cutting needle for acetate; individually ground and lapped. Flattened shank. **39¢**
C439—Package of 3. Your Cost
- (G) Stellite cutter for acetate discs. Extremely quiet. Cuts hundreds of sides; can be resharpened. **\$1.18**
C337—Your Cost Each
- (H) Individually polished steel cutter for acetate discs. Will cut 15 to 25 10-in. discs. **59¢**
C348—Package of 4. Your Cost
- (H) Alloy cutter for acetate; harder than steel. Polish while they cut. Hmd lapped. **95¢**
C434A—Package of 5. Your Cost
C434B—Package of 10. Your Cost

Standard Albums

(A) A well-made album with a durable and attractive maroon cover. Opens flat due to a unique type of construction. An extremely fine value at an unusually low price. Index inside front cover. Shipping weight 2 lbs. each.

Cat. No.	Size	Pockets	Each
C21890	10"	12	78c
C21891	12"	12	94c

Deluxe Record Albums

(B) Flat opening type with heavy kraft pockets. Overall covering of padded brown swirl leatherette. Gold embossed Gothic design on back. Beautiful in appearance and unusually sturdy in construction, this is a truly superior album in every way. Shipping weight 3 lbs. each. Index inside front cover.

Cat No.	Size	Pockets	Each
C21888	10"	12	\$1.28
C21889	12"	12	1.33

LYRIC Record Holder

(C) Why risk broken and scratched records when you can safely file fifty 10" or 12" records in only 12 inches of table or shelf space? Soft red felt covers the unbreakable steel base and separators, keeping your records in perfect condition. Handy indexing system included helps you locate any record in a few seconds. Handles are copper plated. A perfect gift for music lovers. **\$2.33**
C21894—Your Cost

Lyric Record Carrying Case

(D) Stores fifty 10" records safely and conveniently. Aircraft aluminum construction. Very light, exceptionally strong and durable. Comfortable leather carrying handle. Handy indexing system. Protective rubber cushions. Ideal for storing records on trips, picnics, or in the home. Shipping weight 7 lbs. **\$5.30**
C21896—Your Cost

IMMEDIATE SHIPMENT FROM CHICAGO OR ATLANTA

Pick-up Cartridges and Recording Blanks

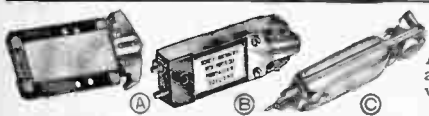

RCA Magic Tone Cell Kit

(A) RCA Victor "Silent Sapphire" jewel point permanent pickup. Sapphire is protected by tiny bumpers and shock absorber. Output volts $1\frac{1}{2}$ at 400 cycles. Includes Magic tone cell, silent sapphire jewel point in cartridge form, and all hardware. **C13960—Your Cost \$4.70**

ASTATIC "QT"

(B) Cartridges Improved design. Output voltage .75. Frequency response to 5000 CFS. Needle pressure of $1\frac{1}{4}$ oz. Model QTM with precious metal tip needle. **C13961—Your Cost \$4.94**

MODEL QTM

With sapphire tip needle
C13962—Your Cost \$5.23
 Replacement needle for Model QTM.
C101—Your Cost \$1.47
 Replacement needle for Model QTM.
C102—Your Cost \$1.76

SHURE "Muted Stylus Cartridge"

(C) Fits all standard flat-type pickup mountings. Output voltage 1.8. With replaceable sapphire tip needle.
C13991—Your Cost \$4.41
 With replaceable osmium tip needle.
C13992—Your Cost \$3.82
 Replacement sapphire needle for above.
C103—Your Cost \$1.47
 Replacement osmium needle for above.
C104—Your Cost 88c

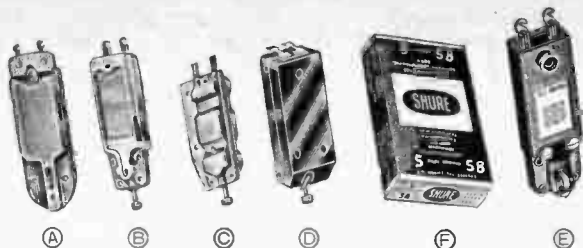

CRYSTAL PICKUP REPLACEMENT CARTRIDGES

A comprehensive lineup of replacement cartridges for all standard makes of crystal pickups as recommended by the manufacturers. Each and every cartridge is precision made and individually tested for rated frequency response and output voltage.

ASTATIC

Stock No.	Model	Type	Pressure	Output	Each
C140	B-4	D	$2\frac{3}{4}$ oz.	2.5 V.	\$3.26
C233	BN-22	B	$2\frac{3}{4}$ oz.	2.9 V.	3.26
C13407	B-2	D	$2\frac{3}{4}$ oz.	2.5 V.	3.26
C13963	*LP-6	A	1 oz.	.85 V.	5.23
C13964	*LP-21	A	1 oz.	.85 V.	5.23
C13965	L-40	B	$1\frac{1}{4}$ oz.	.6 V.	2.62
C13967	*MLP-1-J	B	1 oz.	1.0 V.	5.23
C13969	L-70	B	$1\frac{1}{4}$ oz.	1.0 V.	3.26
C13972	L-71	B	1 oz.	1.0 V.	3.91
C13973	L-26	B	$2\frac{3}{4}$ oz.	1.4 V.	2.62
C13981	L-72	B	$1\frac{1}{4}$ oz.	3.5 V.	3.91
C13982	L-75	B	$1\frac{1}{4}$ oz.	.75 V.	3.26

WEBSTER

Stock No.	Model	Type	Pressure	Output	Each
C13966	N3	B	$1\frac{1}{4}$ oz.	.7 V.	\$2.62
C13970	D4	D	$1\frac{1}{4}$ oz.	.7 V.	3.18
C13971	*D5	D	$1\frac{1}{4}$ oz.	.7 V.	3.91
C13976	C2	C	$2\frac{1}{2}$ oz.	2.0 V.	2.35
C13977	C3	B	$2\frac{1}{2}$ oz.	2.0 V.	2.35
C13978	E4	B	$2\frac{1}{2}$ oz.	1.5 V.	2.62

RCA

Stock No.	Model	Type	Pressure	Output	Each
C215	31050		2.7 oz.	1.5 V.	\$2.52
C249	37158		3 oz.	1.5 V.	2.82
C277	33217		2.7 oz.	1.5 V.	2.52
C280	33122		2.7 oz.	1.5 V.	2.52
C13424	31156		3 oz.	1.5 V.	2.85
C13979	38610		2 oz.	1.5 V.	3.33

SHURE

Stock No.	Model	Type	Pressure	Output	Each
C13968	W42A	B	1 oz.	1.4 V.	\$2.35
C13985	W57A	B	$\frac{3}{4}$ oz.	1.6 V.	2.62
C13986	*W57AN	B	$\frac{3}{4}$ oz.	1.6 V.	4.09
C13987	W58A	B	$\frac{3}{4}$ oz.	1.6 V.	2.62
C13988	W59A	B	1 oz.	2.5 V.	2.62

*Includes needle. †For 90A pickup.

SHURE Replacement Pack

Five standardized lever type crystal cartridges will replace 58 different crystal cartridges. No longer necessary to carry a large stock in order to have the correct replacement. Shure cartridge replacement chart printed on bottom of each pack.

C13990—Your Cost \$14.88

ASTATIC "Nylon-1-J" Cartridge

Incorporates molded Nylon chuck and kneaction, sapphire tipped needle. Control of coupling between needle point and crystal element is nearly perfect. Needle is matched to cartridge, and while it may be replaced, no other needle may be used, thus the quality of reproduction must remain constant.

C13980—With Nylon Needle \$4.56
C114—Replacement Needle 1.76

Record Blanks for Home and Professional Use

PRESTO "ORANGESEAL" Discs Aluminum Base

Famous Presto aluminum base recording discs. Coated with Presto's special compound they have low surface noise and long-playing life. Non-warping and lighter in weight than Green Seal discs listed below. Standard package quantity 50. Lots of 60 ea.

C11960—6 $\frac{1}{2}$ "	Each	\$0.35	\$0.21
C11961—8"	Each	.50	.30
C11962—10"	Each	.75	.45
C11963—12"	Each	1.00	.60

"GREEN SEAL" Discs

Finest grade of recording blank made by Presto. Aluminum Base and coated by a special compound used exclusively by Presto. Used by research laboratories to demonstrate the capabilities of recording equipment. Standard recording blank for a majority of the larger broadcasting stations and recording studios. Overall thickness .052". Standard package quantity 30. Lots of 30 ea.

C11992—12"	Each	\$1.80	\$1.08
C11967—13 $\frac{1}{4}$ "	Each	2.25	1.35
C11993—16"	Each	3.25	1.95

AUDIODISCS

"RED LABEL" Aluminum Base
 For professional use. "Acetate" coated on smooth aluminum base. Double-sided with 3 drive pin holes. .054" overall thickness. Write for special prices in standard package of 25.

C11989—8"	Each	\$0.80
C11994—10"	Each	1.15
C11995—12"	Each	1.85
C11996—16"	Each	3.40

"YELLOW LABEL"

Acetate coated on Aluminum Base. For amateur, school or home use. Double sided and labeled. Std. Pkg. Quan. 25.

C11990—8"	Each	\$0.70
C11997—10"	Each	.90
C11998—12"	Each	1.50
C11999—16"	Each	2.70

RECORDISCS Home Recording Blanks

The Orange and Red Label Discs listed below are all Cellulose nitrate coated, thus providing high fidelity reproduction, and the ability to withstand age and playback without cracking or peeling.

Orange Label

Firm, non-warping bond base, professional nitrate coated. Admirably suited for the average type of amateur transcription.

C11969—SIX 6 $\frac{1}{2}$ " Discs	\$0.60
C11970—SIX 8" Discs	1.00
C11971—SIX 10" Discs	1.40

Red Label

Heavy, .021" thick aluminum base discs with a mirror-like finish for high-fidelity reproduction over a wide frequency range. Comparable to those used by broadcasting stations and professional recording studios.

C11972—6 $\frac{1}{2}$ "	Each	20c	\$0.90
C11973—8"	Each	27c	1.20
C11974—10"	Each	40c	1.80

Aluminum Base Discs

High quality recording discs with a coating of professional nitrate compound on an aluminum base. Low noise level, warp-proof and unbreakable. Light weight.

Stock No.	Size	Price Ea.	Per 10 Ea.
C11955	6 $\frac{1}{2}$ "	20c	18c
C11956	8"	27c	24c
C11957	10"	40c	36c
C11958	12"	53c	47c

WILCOX-GAY RECORDIO Discs

Lightweight, flexible discs for use with home recorders. Non-inflammable. Excellent recording quality. Coated and label both sides.

C11979—SIX 6 $\frac{1}{2}$ " Discs	\$0.60
C11980—SIX 8" Discs	1.00

GOULD-MOODY Professional Record Blanks

Professional quality blanks having a perfectly uniform coating of highest grade cellulose nitrate on smooth aluminum base. Mirror-like surface will permit recording with utmost fidelity and lowest noise level to produce professional results. Overall thickness .063". 2-hole type.

Stock No.	Size	Price Each	Per 25 Ea.
C11986	10"	\$0.84	\$0.68
C11987	12"	1.36	1.09
C11988	16"	2.50	2.00

MASTER Discs

Cellulose coated aluminum based discs used extensively by phonograph record and electrical transcription manufacturers for making original master recordings. Not affected by humidity or changes in temperature.

Stock No.	Size	Price Each	Per 12 Ea.
C11950	13 $\frac{1}{4}$ "	\$2.24	\$1.79
C11951	17 $\frac{1}{4}$ "	3.75	3.00

Record Renewer

For acetate records. Cleans, lubricates and protects. Thin film of lubricant reduces friction. 2-ounce bottle.
C15300—Your Cost 26c
Renewer: Same as above but for commercial records such as RCA, Victor, Columbia, Decca, etc. 2-ounce bottle.
C15301—Your Cost 29c
Recording Fluid: Applied to recording blank before cutting, increases stylus life, reduces surface noise. For use on non-inflammable discs only. 2-ounce bottle.
C15302—Your Cost 38c

Gummed Record Labels

Neatly printed spaces for title, date and name of recorder. Fits all discs.
C431—Package of 50 32c



RECORDERS And Transcription Playbacks

PRESTO Model Y Recorder

A Highest quality 16" dual speed portable recorder and playback. Handles up to and including 17 1/2" transcription masters. Serves 500 people as a public address system. Uses the famous Presto 1-C cutter, magnetic, normally flat 50-8000 cps; equalized, 50-10,000 cps. Negligible harmonic distortion. Wide dynamic range. Turntable is directly driven by pulley on motor shaft to eliminate vibration and hold speed absolutely constant. Speed changed instantly, outside-in or inside-out cutting changed instantly, and cutter gently lowered to surface, all by levers. Vibration damper on cutter eliminates vertical modulation. Highest quality 16" magnetic pickup. Quick disengage for cutting spiral runouts. Time scale. Under-panel, chip-free mechanism equal in every way to overhead lathe. 2-mike mixer, high and low freq. equalizers, and changeover switch for continuous cutting. Model Y-2 consists of the Model 76-A recorder and playback in its own case and the Model 87-A amplifier and speaker in its own case. The only accessories needed are a high-impedance mike, discs, stylus, and needle.

Amplifier uses two 6SJ7's, a 6N7, two 6C8C's, two 2A3's push-pull, and a 5Z3. Gain 115 db. Output 10 watts. Freq. response flat 30-10,000 cps. Treble control raises 6500 cps as much as 17 db or drops 5 kc as much as 20 db. Bass control raises 100 cycles as much as 20 db. Distortion less than 1% at maximum cutting level. Panel includes a volume indicator meter, telephone line input jack, monitor jack, and dual receptacles for turntables and mikes. Mike input 100,000 ohms, line input 500 ohms, output 8 ohms. Speaker is 10" PM dynamic, mounted in the baffled case cover.

Model 75-A recorder and playback is 20 1/2 x 11 x 19". Weight 49 lbs. Shpg. wt. 68 lbs. Model 87-A amplifier and speaker is 23 1/2 x 12 x 20". Weight 57 lbs. Shpg. wt. 85 lbs. Total Model Y-2 Shpg. wt. 153 lbs. For 115 volt, 60 cy AC. Complete with tubes and instruction book.

C22586—Your Cost \$741.00

C22587—Model 75-A Only, Your Cost . . \$451.00

C22588—Model 87-A Only, Your Cost . . . 290.00

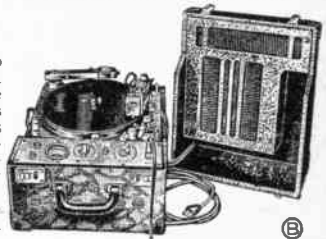

PRESTO Model K Recorder

B Complete recorder-playback unit. Records up to 15 minutes continuously on one side of 13 1/2" disc. Connects to any home radio, microphone, or another phono pickup to duplicate records. Plays all makes of records. As voice amplifier, serves audiences of 500 persons. Ideal for sales work, schools, actors, musicians, and home recording. In beautiful portable case, light-weight and compact.

Two speed, 33 1/3 or 78 rpm. Speed accuracy 0.5%. No belts. Change speed in 5 seconds. 12" turntable machined from heavy casting. Heavy-duty constant-speed motor. Highest quality magnetic cutter and pickup heads, flat 80-5000 cps. Stylus-saving cam-type lever to lower the cutter. 112 line/inch under-panel cutting mechanism, chip-free, with

quickly replaceable worm for either outside-in or inside-out cutting. 110 db amplifier gain, flat 50-8000 cps. High-freq. equalizer for 33 1/3 rpm recording, maximum 20 db up at 6 kc. Playback scratch filter, maximum 25 db down at 5 kc. Volume-indicating meter. Monitoring jack. 8" PM speaker in baffled case cover with extension cable.

Tubes: three 6SQ7 stages, 6N7, push-pull 45's, and 80. Complete with tubes and instruction book, with outside-in cutting worm. (Extra worm for inside-out by special order, slightly additional.) The only accessories needed are a high-impedance microphone, discs, stylus, and needle. Dimensions: 19 1/2 x 15 1/2 x 11". Weight 46 lbs. Shpg. wt. 69 lbs. For 115 volts, 60 cycle AC.

C22585—Your Cost \$348.00



TECHNO CRAFT Professional Cutter

D Accurate, for professional or amateur. Fits all standard turntables. Positive screw engagement, chip guard, many other refinements. 110 lines/inch, outside-in. Choice of Astatic X-26 Crystal or M-41 8-ohm Magnetic cutters. 12" Model, Crystal.

C22565—Your Cost \$60.00

C22566—12" Magnetic . . . \$60.00

C22567—16" Crystal 70.00

C22568—16" Magnetic 70.00

PRESTO Model L Transcription Playback

C Professional quality portable playback. Attractive, workmanlike appearance, small size, light weight. Remarkably clear wide-range reproduction. Consists of: 12" dual-speed, rim-driven recording turntable, high-quality 16" magnetic pickup, 4-stage amplifier, 8" speaker mounted in baffled case cover with 20-ft. extension cable, and Presto Transcription needle. Has tone control to adjust response for all makes of lateral recordings.

Overall frequency response 80-7500 cps. Lateral-type pickup, needle pressure 1 1/4 oz. Speed accuracy less than 0.5%. Amplifier gain 70 db, output 4.5 watts undistorted. Tubes are 6SF5, 6N7, push-pull 45's, and 80. Dimensions: 19 1/2 x 15 1/2 x 11". Weight 46 lbs. Shpg. wt. 69 lbs. Model L-2, complete with tubes, for 115 volts, 60 cy AC.

C22589—Your Cost \$290.00

Available for other line frequencies on special order.

REK-O-KUT Recording Equipment

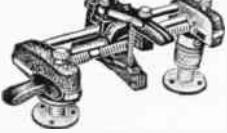

REK-O-KUT Recording Equipment Professional Cutter

E New design. Rugged, simple, positive features demanded by Broadcast engineers. Precision stainless-steel feedscrew shadowgraphed for accuracy. Slide bars and gauge chromed for easy, wear-free operation. Enclosed gears, no chip binding. Universal mount, quick cutter interchange. Cut spirals any width, not limited by pitch of screw. Model B-5 has Brush RC20 Crystal cutter; 120 lines/inch; outside-in. Shpg. wt. 16 lbs.

C22590—Your Cost \$175.00

Special Hi-fidelity transformer to match Brush or any high-imp. cutter to 8 or 500 ohm line.

C22593—Your Cost \$9.50

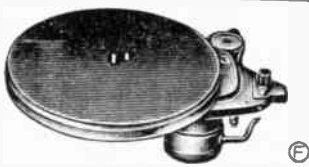

16" Recording Motor

F Precision dual-speed 16" assembly. Lathe turned, dynamically balanced 25 lb. cast-iron turntable with 1" dia. shaft. Special grooves force-feed oil when operating. 1/20 H.P. constant-speed motor. One 78 and one 33 1/3 rpm idler. Adjustable stops regulate idler pressure against turntable. 10 lb. machined mounting base with integral lathe-bored and lapped turntable bearing. Shpg. wt. 50 lbs.

C22595—Your Cost \$165.45

Recording level meter in streamlined case. Operates from output of 8, 15, 200 or 500 ohm amplifier.

C22594—Your Cost \$29.50



PARA-FLUX Playback Equipment Reproducers

G Rugged 16" magnetic, with equalizer and 5-pos. de-emphasis switch. Outputs from 30 to 600 ohms at -43 to -53 db below 1 mw. Heads quickly interchangeable. Adjustable height. Flat 40-11,000 cps. Permanent diamond stylus, pressure 35 grams. Moving mass 22 milligrams. Complete assembly is Head, Diamond, Arm, Equalizer and Switch. Shpg. wt. 9 lbs. Model UL-1DA with Universal Head.

C13454—Your Cost \$166.50

Model VL-1DA with Vertical Head.

C13455—Your Cost . . \$150.00

C13456 Model LL-1DA with Lateral Head.—Your Cost \$120.00

NOTE: Replacement heads available at \$35.00 on exchange basis.

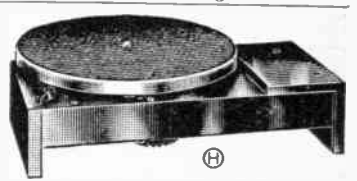

16" Turntable

H Model TP-16, companion to the Para-Flux Reproducer. Smooth, silent, trouble-free. Meets all requirements of Broadcasting studios. 78 or 33 1/3 rpm. Heavy-duty constant-speed motor with oversize bronze bearings and dual speed control, in full-floating mount on steel base plate. Speed control completely disengages driver and idler in "off" position, thus preventing "flats" on the drive-mechanism surfaces. Specially formed spindle gives "wowless" performance. Shipped in wood utility mounting suitable for permanent installation. 21 1/2 x 16 x 5 1/2".

C22509—Your Cost \$78.80

Pilot Lamps AND SOCKETS

Genuine EVEREADY-MAZDA Pilot Light Bulbs

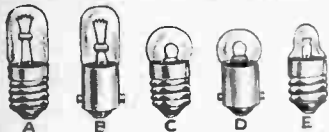

Both pilot and flashlight type bulbs are listed below. 6-8 volt bulbs are for 6.3 volt receivers. Bead colors aid in identifying bulb types. Eveready-Mazda bulbs are standard in most makes of radios.

Prices Below Include Federal Excise Tax.

Tubular Bulb, Miniature Screw Base (A)

Stock No.	Type	Bead Color	Volts	Amps.	Ea.	10 For	100 For
C12274	48	Pink	2.0	.06	15c	99c	\$8.91
C12250	41	White	2.5	.50	9c	60c	5.40
C12254	40	Brown	6-8	.15	9c	60c	5.40
C12252	46	Blue	6-8	.25	9c	60c	5.40

Tubular Bulb, Miniature Bayonet Base (B)

C12260	43	White	2.5	.50	9c	60c	5.40
C12259	49	Pink	2.0	.06	15c	99c	8.91
C12249	44	Blue	6-8	.25	9c	60c	5.40
C12284	47	Brown	6-8	.15	9c	60c	5.40

Round Bulb, Miniature Screw Base (C)

C12273	50	White	6-8	.20	10c	66c	5.94
--------	----	-------	-----	-----	-----	-----	------

Round Bulb, Miniature Bayonet Base (D)

C12261	51	White	6-8	.20	8c	49c	4.41
C12285	55	White	6-8	.40	8c	49c	4.41

FLASHLIGHT BULBS

G-3 1/2 (C) is small round. G-4 1/2 is large round. TL-3 (E) is lens bulb. P-3 1/2 (not illustrated) is pre-focused miniature flange type bulb.

Stock No.	Type	Bead Color	Volts	Amps.	Ea.	10 For	100 For
C12200	13(G-3 1/2)	Green	3.8	.30	9c	60c	\$5.40
C12201	14(G-3 1/2)	Blue	2.5	.50	9c	60c	5.40
C12202	605(G-4 1/2)	Brown	6.0	.50	10c	66c	5.94
C12203	222(TL-3)	White	2.2	.25	9c	60c	5.40
C12204	112(TL-3)	Pink	1.1	.22	9c	60c	5.40
C12205	233(G-3 1/2)	Purple	2.3	.27	9c	60c	5.40
C12206	PR2(P-3 1/2)	Blue	2.4	.50	13c	86c	7.74
C12207	PR3(P-3 1/2)	Green	3.6	.50	13c	86c	7.74
C12208	263X(G-3 1/2)	Blue	2.6	.30	10c	66c	5.94

Candelabra Base

110-120 V. Pilot Lights

Genuine GE Mazdalamps. Type S-6.

C12257—6 watts **16c**

Each

Type C-7. As above, but cone shape

7 watts. Available in White Frosted,

C12280; Clear—C12275. **11c**

Either Type, Each

Tubular Candelabra Base

110-120 Volt Pilot Lamp

A brand new 4-watt lamp that is ideal for use behind small panel openings, dials, etc. Looks just like a radio pilot lamp. Size: 1/2" diam. 1 1/8" long.

C12272—10 for \$3.56. **39c**

Each

VICTOR Pilot Bulb

Intermediate base, frosted bulb. 110, 120 volts. For Colonial, Victor and other receivers.

C12253— **19c**

Carton of 10, \$1.71. Each

Dial Light Coloring

Kit of colors, Red, Green, Blue and Amber, and a bottle

of solvent. Each in screw top, wide mouth bottle. Dries in 1 minute. Color is permanent.

C15185— **41c**

Your Cost, Per Kit

1" Enclosed Pilot Light

Underwriters' Approved single unit socket assembly unaffected by heat. All porcelain and brass construction. For standard S6 lamp, removable from front of panel. Single 1" hole mounting. Faceted red or green jewel.

C14140—Red Jewel **94c**

C14141—Green Jewel

Either Type, Your Cost.



GE NEON GLOW LAMPS

Used extensively in test instruments. On DC, only the negative electrode glows. All except 1/2-watt types operate on 105-125 volts AC or DC and require minimum starting voltages (approx.) 65 on AC, 90 on DC. 1/2-watt minimum starting voltage 105—recommended only for AC not DC. All have clear glass except C12263 which is finished orange. Prices include Fed. Tax.



Stock No.	Watts	NE No.	Bulb	Base	Start AC	Volts DC	Your Cost	10 For
C12266	1	NE30	G10	A	60	85	40c	\$3.60
C12267	2	NE34	S14	A	60	85	50c	4.50
C12263	2	NE34	S14	A	60	85	50c	4.50
C12276	3	NE40	S14	A	60	85	60c	5.40
C12264	1/2	NE45	T 4 1/2	B	65	90	40c	3.60
C12215*	1/25	NE51	T 3 3/4	C	65	90	10c	.90
C12216*	1/25	NE2	T2	D	65	90	8c	.72
C12268*	1/2	NE48	T4 1/2	E	65	90	35c	3.15
C12269*	1/2	NE29	G10	E	105	...	45c	4.05
C12270*	1	NE32	G10	E	60	85	45c	4.05
C12271*	2	NE36	S14	F	60	85	55c	4.95
C12209*	1/2	NE7	T4 1/2	D	...	70	31c	2.79

*Resistorless type.

Bases: A: Standard Edison. B: Candelabra screw. C: S.C. Min. Bay. D: Wire terminals. E: 2-Cont. Bay. F: Sk. D.C. Bay. Cand.

Porcelain Receptacles

For neon glow lamps, etc. Mtg. hole spacing all types 1 1/8" except C13327 which is 2". C13387 requires 1/16" socket hole in addition.



C13331—Candelabra (B)	C13327—Edison (B)	13c
C13330—Miniature (B) Ea.	C13387—Candelabra (A)	33c

2-Contact Cand. Bay. Metal Shell Sockets

Base Mtg. 1 1/8" d., 1 1/8" h. Bakelite base. Screw terminals.

Flush Mtg. Requires 1 1/8" hole plus mtg. holes 1 1/4" apart.

C13332 **48c**

C13389 **29c**

Full-View Neon Pilot Light

Full view plastic head pilot light with built-in resistor for operation on 110 volts. Uses C12215 neon bulb listed above. Head unscrews to replace bulb from front panel. 1 1/8" long, extends 7/8" in front of panel. With mtg. nut and washer, threaded 1/16"-27.

C14181—Red Head

C14182—Amber Head.

C14183—Opal Head.

Any Color—Your Cost.

88c

Miniature Panel Light

For panel mtg. S.C. Min. Bay. Base. Mts. in 3/8" hole. With 12" lead, nut and washer.

C6436—

Each **38c**



Front Removable Jewel Brackets



Mounts in 1 1/8" hole. 1/2" jewel removable; bulb can be replaced from front. Miniature

screw base. Fit tubular bulbs only.

C6416—Red C6417—Green

C6418—Amber C6425—Opal

Any Type, **29c**

Each

Same, but Miniature Bayonet Base

C6408—Red C6409—Green

C6410—Amber C6411—Opal

Any Type, **29c**

Each

Giant 1" Jewel Brackets

1" diameter faceted jewels. Candelabra takes 3 or 6-watt 110 V. bulb.

Color Candelabra Base Miniature Bayonet Base

Red C6403 C6404 C6465

Opal C6321 C6324 C6327

Green C6322 C6325 C6328

Amber C6323 C6326 C6329

Any Type Above, **59c**

Each

Pilot Light Sockets Miniature, Candelabra, Bayonet Base



Min. Screw A C6510 Min. Bay B C6488 Cand. Base C6539

C6511 } each **5c** C6489 } each **7c** C6537 } each **10c**

C6512 } C6510 } C6540 } C6541 }

C6513 } C6514 } C6564 }

10 for 48c 10 for 64c 10 for 90c

100 for \$4.32 100 for \$5.76 100 for \$8.10

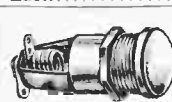

Reliance Bull's Eye

Takes candelabra base bulbs type S-6. For panels up to 1/2" thick. 1" diameter clear glass jewel with set of 4 color discs—red—green—amber—white. Polished chrome. Jewel bezel.

C14174—Your Cost **76c**

C14175—Similar to above, but with red or green faceted 1" jewel. Specify color.

C14176—Same but with miniature base. **76c**

Either Type, Your Cost Each

Jewelled Pilot Brackets

Fine quality jewelled pilot brackets, for amplifiers, transmitters, etc. All have faceted jewels, highly polished nickel-plated steel brackets. Standard jewelled brackets have 1/2" jewel requiring a 7/16" mounting hole. Jumbo brackets have a 3/4" jewel, requiring a 1 1/8" hole. Available with Candelabra 110 V., Miniature Bayonet and Miniature Screw base sockets.

Base Type Standard Size

Min. Screw Green C6433 19c Red C6432 19c Amber C6434 19c

Min. Bay. C6456 19c C6454 19c C6458 19c

Cand. C6427 21c C6426 21c C6428 21c

Faceted Jewels Only

C6430 12c C6429 12c C6431 12c

Assembly With 3/4" Jewel Each

Min. Screw C6330 C6331 C6332 35c

Cand. C6333 C6334 C6335 35c

Due to limited space, we are unable to list all pilot lights and bulbs available directly from stock in Chicago and Atlanta. Write us your requirements. Your correspondence will receive prompt attention.



SPECIAL VALUES

Portable Electric Record Player and Changer

Plays Half Hour of Continuous Music

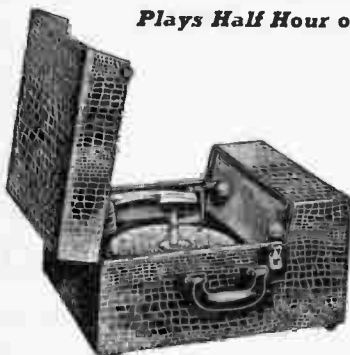

An amazingly versatile, fine quality unit at an exceptionally low price. Comprises an improved automatic record changer-power amplifier and speaker. Changer will play continuously at a single loading with cabinet cover closed, ten 12" or twelve 10" records. Any record can be rejected when desired with the press-to-ject button which also serves as automatic manual, and on-off switch. All-in-one control conveniently located. Easy loading and gentle with your records. Will

not jam even if you are careless. New silent type, constant, self starting, rim drive motor with 9" turntable. Fine Astatic crystal pickup with extremely low needle pressure gives wide frequency range and minimum surface noise. Ideal for multitude of uses. Can be carried without fear of moving parts. New locking device protects pickup arm and turntable to insure complete portability. Separate tone and volume control permits adjustment to desired response. Tube complement: 1—12S J7, 1—50L6GT, 1—35Z5GT. High fidelity reproduction by 6" PM dynamic speaker. Portable carrying case finished in attractive simulated alligator skin with leather handle and snap locks. Overall dimensions 18 1/2" x 15 1/4" x 9 1/4". Complete with tubes and speaker—ready to use. Shpg. wt. 33 lbs.

C22521—
Your Cost

\$44.75

RECORD CABINETS

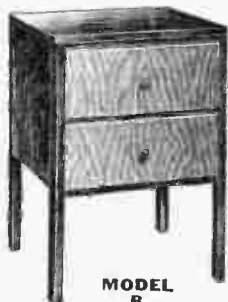

MODEL
B



MODEL
C

We are proud to present four new record cabinets, to fit the needs of those record enthusiasts who not only want convenient storage space for their record collections, but also appreciate and love good furniture.

Model A and Model B are identical in size, styling, capacity, and finish, except Model A is supplied less doors. Modern streamline round corner design harmonizes with practically all furniture settings. Large size top is adequate for most present day table model phono combinations. Semi concealed album partitions and clear shelf space make the cabinet adaptable for use for books, knickknacks, etc., for users that do not have sufficient albums to fill entire case. A stop cleat is provided so that 12" records are self aligning merely by shoving record album against the cleat. Cabinet is built to finest furniture standards with select hardwoods and veneers and is beautifully finished to fit into fine home surroundings. Size: 19 3/4" wide, 17 3/4" deep, 28 1/2" high. Holds 9 12" albums, 108 records.

Model C is a double tier cabinet without doors for larger collections of albums. Holds 18 albums, 216 records. Size: 19 3/4" wide, 17 3/4" deep, 33" high.

Model D is a large modern cabinet with double doors designed for the storage of large record collections. Flush-to floor design with record storage space divided into two tiers. Dividers for holding albums upright. Constructed of 1 1/2" 5-ply mahogany veneer, with a beautiful lustrous piano finish on all surfaces. A really magnificent piece of furniture. Holds twenty albums, 240 records. Size: 24" wide, 16" deep, 31" high. Will really accommodate a record player or radio on top. Highest grade distinctive cabinet hardware.

Model	Stock No. Mahogany	Stock No. Walnut	Shpg. Wt.	Your Cost
A	C25763	C25762	26 lbs.	\$15.90
B	C25765	C25764	31 lbs.	19.35
C	C25767	C25766	35 lbs.	21.85
D	C25759	C25760	50 lbs.	42.95

CLASSOPHONE Record Storage Facilities



The modern way to store, protect and classify phonograph records for instant use. Classophone Pockets are hinged at the base, firmly anchored in the cabinet into which it is built. Each Classophone Pocket is clearly numbered; each number corresponds with gummed label supplied for affixing to record; number is then placed on index file or index book. Comes in portable carrying cases or in kits for building into your own cabinet or bookshelf. Each pocket holds either a 10" or 12" record.

Portable No. 3: In convenient, sturdy portable carrying case, finished in beautiful simulated alligator leather with smart matching trimmings. Ideal for motor trips, musicians, sound system operators. Includes 25 Classophone Record Holders complete with numbered stickers; index; lock and key for case.

C21876—Your Cost **\$11.61**

Portable No. 4: Same as Portable No. 3 described above except has 50 pockets.

C21877—Your Cost **\$16.17**

Kit No. 1: 25 Classophone Pockets for installation in your own cabinet or bookshelf. Includes numbered stickers, index reference leaflet, construction diagram.

C21878—Your Cost **\$5.14**

Kit No. 2: Same as Kit No. 1 described above except has 50 pockets.

C21879—Your Cost **\$10.28**

For Commercial Use: Classophone Kits are available in large lots for radio stations, schools, manufacturers with wired music systems, etc. Write for quantity prices.

Two Station Intercom

- ★ Operates on AC or DC
- ★ Noise Silencing Switch
- ★ Remote Station up to 1000 Feet Distant



Complete two way intercommunication system for use in garages, restaurants, stores, factories, business offices or the home. No special knowledge or tools required. Any 2 conductor wire used for remote station connection up to 1000 feet distant. 105-120 volts AC-DC. Either station may be hung on wall by means of screw slots in the back. Cases moulded of durable hard plastic. Attractive polished mahogany finish. Master unit has noise silencing switch. Each unit measures 8 1/2" high, 6" wide, 4" deep.

Complete with all tubes in place, 6 ft. rubber cord, 50 ft. connecting wire, one master and one sub-station, ready to operate.

C22364—Shpg. wt. 7 lbs. **\$19.84**

Your Cost

Multiple Station Intercom

Master Station Only, same as used in the 2-station set above. Output 2 watts; speaker 4-inch Alnico V PM; tubes 12SJ7GT, 50L6GT, 35Z5GT. Shpg. wt. 7 lbs.

C22365—Your Cost **\$16.17**

Remote Station Only, same as used in the 2-station set above except has addition of push-button switch to originate call to master station. Up to 5 remote stations may be used with the master.

C22366—Your Cost **\$4.77**

Selector Switch Only, for use by the master station to select any one of the remote stations. Simple detailed installation instructions packed with each unit. No matter which button is pressed, any of the remote stations can "come in" to originate call. No solder connections necessary. 6 push buttons, 5 for station selection by master, the sixth to return system to neutral. Mounts anywhere. Shpg. wt. 2 lbs.

C22367—Your Cost **\$5.51**

Twisted Pair Intercom Wire, to connect Selector Switch to any remote station up to 1,000 feet away.

C16013—Your Cost Per Foot **1 1/2¢**

Ferret Signal Generator

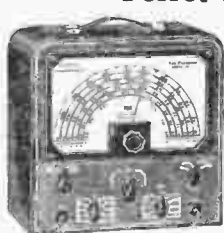

Model 701 FM-AM signal generator. Large 9" three color scale, glass covered. Frequency range 170 kc to 220 mc, fundamental frequency to 110 mc. Unit completely shielded for minimum radiation. Crystal calibrated, low loss, permeability tuned RF coils. 0 to 100% internal 400 cycle sine wave modulation. Electron coupled combination Hartley and Colpitts oscillator for high LC ratio, low fluctuations. Low loss, low impedance, coaxial cable output. Ladder attenuator. Vernier drive with 3 to 1 ratio. Housed in an attractive, blue-gray Hammertone finished aluminum case, 10 1/2" x 10 1/2" x 5 1/2". For 110v 60 cycle AC.

C21432—Your Cost **\$74.95**

USE OUR ORDER BLANK FOR FASTEST POSSIBLE SERVICE

WALSCO 4U Line

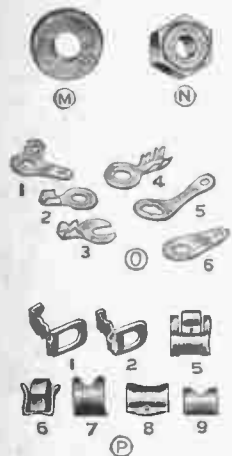
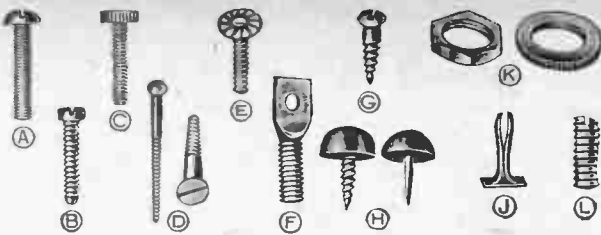

Machine Screw Assortment

(A) All standard sizes used in electronic and similar work in handy inexpensive assortment. Contains approximately 50 Nos. 6, 8, 10 screws $\frac{1}{8}$ " to 1" long.

C15456—Assortment
C15457—6-32x $\frac{3}{8}$ ", pkg. of 60.
C15458—6-32x $\frac{1}{2}$ ", pkg. of 50.
C15459—8-32x $\frac{1}{2}$ ", pkg. of 40.

Small Machine Screw and Nut Assortment

(A) Special assortment of extra small screws and nuts Nos. 2 and 4 needed in electronic and experimental work; for fastening small parts, and for replacing rivets. Approximately 40 assorted screws and 40 assorted nuts.

C15455—

Self Tapping Screws

(B) Cut their own thread in either metal or plastic. Ideal for mounting parts on chassis, replacing rivets and eyelets. Package of approx. 30 assorted sizes.

C15450—Assortment
C15451—pkg. approx. 40, size 6x $\frac{1}{4}$ ".
C15452—pkg. approx. 35, size 8x $\frac{3}{8}$ ".

Phonograph Pick-up Set Screws

(C) Knurled head steel screws, antique bronze. For popular pick-ups and recording heads. Approx. 10 asst.

C15409—

Wood Screw Assortment

(D) Handy assortment for workshop or home. Contains approx. 30 round and flat-head screws of popular sizes in brass and steel.

C15453—

Ornamental Screws

(E) Antique bronze finished rosette head screws for mounting speakers. Package of 15 assorted sizes.

C15449—

Spade Bolts

(F) Indispensable for attaching condenser coils, IF cans, for Experimenters, Servicemen and manufacturers. Stud size 6-32 Hole size No. 6. Package of approx. 25 assorted lengths.

C15443—

Small Screw Assortment

(G) Assortment contains approx. 60 small wood, brass and steel screws sizes 1 to 3 up to $\frac{3}{8}$ " for name plates and escutcheons.

C15454—

Rubber Feet

(H) Made of oil resistant synthetic rubber for radio phonograph and amplifier bases. Available in screw or tack type. Package of 12 assorted screw type.

C15407—

Package of assorted tack type.

C15408—

Snap-in Trimounts

(J) Eliminates use of screws on radio back covers, dial scales, chassis built in antennae. Speeds up assembly and repair.

Stk. No.	Lnth.	For Hole	No. Pcs.
C15438	1 1/4"	1/8"	25
C15439	1 3/4"	1/8"	25
C15440	1 7/8"	1/8"	25
C15441	1 3/4"	3/16"	20
C15442	1 1/2"	3/16"	20

Special Mounting Nuts

(K) Various kinds of nuts used on volume controls, switches, jacks and potentiometers. A must for every radio man and electrician. Cadmium or nickel plated. Package of approx. 15 assorted.

C15445—

Steel Set Screws

(L) Hardened steel set screws, all popular sizes for radio knobs, record changers, automobile radios. Package of approx. 20 assorted sizes.

C15400—

Metal Washers

(M) Cadmium plated. Steel washers. Package of approx. 100 assorted small sizes.

C15433—

Machine Screw Nuts

(N) Nuts are "Small Pattern" preferred in the electronic and electric trades. Cadmium plated.

Stock No.	Size	Approx. No.
C15446	Asst.	50
C15447	6-32	50
C15448	8-32	40

Terminal Lugs

(O) Available in six popular sizes for radio and electronic work. Made of tinned brass.

Stock No.	Fig. No.	Approx. No.
C15419	Asst.	40
C15420	1	30
C15421	2	30
C15422	3	30
C15423	4	30
C15424	5	30
C15425	6	40

24c

Any Item On This Page

Radio Knob Spring

(P) Finest grade selected steel springs in all regular sizes and shapes. Pkg. of approx. 20 assorted.

C15437—

Expansion Springs

(A) Handy for radio, electrical shops, laboratories. Assortments contain various sizes for record changers and dial drives.

C15434—10 Asst. large springs.
C15435—10 Asst. small springs.

Fuse Insulators

(B) Highest quality inulators for use on automobile radios. Two lengths included fit all standard $\frac{1}{2}$ " diameter fuses. Pkg. approx. 16 asst.

C15405—

Fuse Clips

(C) Made of nickel plated spring brass for single hole mounting. Pkg. 12 assorted.

C15426—

Speed Nuts

(D) Self locking and easy to install. For replacement on record changers, tuning units. Package of approx. 30 assorted sizes.

C15401—

Retaining Rings and "C" Washers

(E) Standard types and sizes required for radio, electrical and electronic repair work. For servicing of volume controls and record changers. Assortment contains sizes for shafts $\frac{1}{8}$ " to $\frac{3}{8}$ " diameter.

No.	Description	Approx. No.
C15427	Rings and Washers	40
C15428	Ring $\frac{1}{8}$ " shaft	50
C15429	C washer $\frac{1}{8}$ " shaft	30
C15430	C washer $\frac{3}{8}$ " shaft	35

Chassis Mounts

(F) Long lasting resilient synthetic rubber. To give chassis floating effect. Pkg. of 10 assorted.

C15432—

Phono Motor Rubber Drives

(G) Exact replacements for standard motor drives. Precision made to assure constant speed. Made of abrasion resistant synthetic rubber for long wear.

Stock No.	I.D.	O.D.	Thick	No. per pkg.
C15413	2"	2 1/2"	3/16"	2
C15414	1 1/2"	1 3/4"	3/16"	2
C15415	1 3/4"	1 7/8"	3/16"	3
C15416	1 3/4"	1 7/8"	1/8"	4
C15417	5 3/4"	6"	1/8"	1

Cord Strain Reliefs

(H) Provides a grommet and strain relief in one piece. For use on appliance, radio and amplifier power cords. Will prevent insulation of wire from being cut or damaged.

Package of 4.

C15431—

Angle Brackets

(J) Handy brackets of various lengths and shapes. Precision made of steel, or brass and plated. Pkg. of approx. 15 assorted.

C15418—

Acorn Nuts

(K) Improves appearance on panel assemblies and cabinets. Pal type steel nuts, self locking. Cadmium plated. Pkg. of 12 assorted.

C15444—

Spacers

(L) Assortment of metal and insulating spacers. Accommodates No. 6 and No. 8 screws.

C15402—Pkg. approx. 12 asst. insulating.

C15403—Pkg. approx. 12 asst. metal.

Small Cotter & Hairpins

(M) Package contains assortment of most popular sizes of cotter and hairpins. Valuable aid in radio and phonograph repair. Package of approx. 50.

C15406—

Spring Washers

(N) For record changers and automatic tuning assemblies. Assortment of phosphor-bronze and steel friction washers. Approx. 25 asst.

C15404—

Key Wrenches

(O) Three assts. of key wrenches to fit all standard Hex and spline socket screws used in radio and electronic equipment.

Assortment of 5 small Hex wrenches Fits set screws No. 4 to $\frac{1}{4}$ " and cap screws No. 2 to 8.

C15410—

Assortment of 4 medium Hex wrenches. Fits set screws No. 8 to $\frac{3}{8}$ ".

C15411—

Assortment of 4 small Spline wrenches. Fits set screws up to $\frac{1}{4}$ " and cap screws up to No. 8.

C15412—

RADIO HARDWARE IN JARS

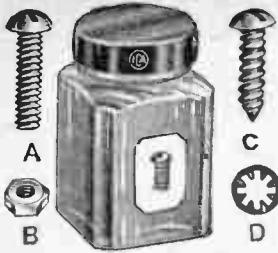

The most convenient, neatest way to keep your small hardware—in glass jars with screw-on caps.
Your Cost, 33¢
Any Jar.....
C14675—Jar only.....6¢

P-K Tap Screws (C)

No.	Quantity	Size
C14665	50	No. 4x 1/4"
C14666	50	No. 6x 1/4"
C14667	45	No. 6x 1/2"
C14668	40	No. 7x 1/4"
C14669	35	No. 10x 1/4"
C14670	45	No. 10x 1/2"

Hexagon Nuts (B)

No.	Quantity	Size
C14661	110	4-36x 1/4"
C14662	110	6-32x 1/4"
C14663	90	6-32x 1/2"
C14664	90	8-32x 1/2"

Washers (D)

C14671	150	No. 6 Plain
C14672	150 <td>No. 8 Plain</td>	No. 8 Plain
C14673	100 <td>No. 6 Lockwasher</td>	No. 6 Lockwasher
C14674	100 <td>No. 8 Lockwasher</td>	No. 8 Lockwasher

Round Head Machine Screws (A)

No.	Quantity	Size
C14650	100	4-36x 1/4" long
C14651	100	4-36x 1/2" long
C14652	75	4-36x 3/4" long
C14653	90	6-32x 1/4" long
C14654	80	6-32x 1/2" long
C14655	70	6-32x 3/4" long
C14656	75	8-32x 1/4" long
C14657	70	8-32x 1/2" long
C14658	65	8-32x 3/4" long
C14659	60	10-32x 1/4" long
C14660	50	10-32x 1/2" long

Display and Utility Rack



Handy metal rack for your workbench, shelf, or wall. Consists of 4 shelves for storing 36 hardware jars, small parts, and miscellaneous items. 12x16x8". Shpg. wt. 4 lbs.
C22354—Your Cost \$3.23

Hardware Assortment

Over 1000 pieces of hardware items. Contains Rivets, set screws, eyelets machine screws, lugs etc. 3 1/2"x3 1/2"x2 1/2". Weighs over 2 lbs A bargain assortment unequalled anywhere. Don't delay! Order Now! Shpg. wt. 3 lbs.
C14833—Your Cost Only 79¢



DeLuxe Hardware Assortment



Our most popular hardware assortment conveniently boxed. Contains over 1000 pieces of the most frequently used hardware, including assorted machine screws—woodscrews—nuts—bolts—rivets—eyelets—lugs—lock washers—fiber washers—rubber grommets, etc. Finest quality hardware. Shpg. wt. 4 lbs.
C14831—Your Cost, per Box 97¢

Rivet and Eyelet Asst.



Special assortment of 55 popular size rivets and eyelets to fasten sockets, etc.
C14840—55 Asst. 24¢
Your Cost

Insulating Washers

Of fibre. Used for metal panel and chassis mounting of parts.



Stock No.	O.D.	I.D.	Per 10	Per 100
C15020	1"	3/4"	11c	99c
C15021	1 1/4"	1"	8c	72c
C15022	1 1/2"	1 1/4"	7c	63c
C15023	1 3/4"	1 1/2"	7c	63c
C15025	2"	1 3/4"	7c	63c
C15026	2 1/4"	2"	6c	54c

Escutcheon Pins



Antique finish—3/8" long. For fastening all types of escutcheons or nameplates.
C14811—Per 100 14¢
Your Cost

Escutcheon Screws

Round head, antique finish, 3/8" long. Fits any type escutcheon.
C14934—No. 2 size 39¢
Per Gross

1/4" Metal Spacers



For raising components above chassis or away from panel. All pass, Nos. 4, 6 and 8 screws.

Stock No.	Height Inches	For Ten	For Lots of 100
C9868	1/4"	21c	\$1.89
C9869	3/8"	25c	2.25
C9870	1/2"	29c	2.61
C9871	3/4"	32c	2.88

Assorted Brackets

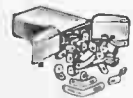

Box of 28 of the most popular angles and brackets used in radio. Made of heavy metal.
C14838—Your Cost 41¢

Assorted Fibre Washers



Contains 100 plain and shoulder type to fit Nos. 6, 8 and 10 screws, as well as 1/4", 3/8" and 1/2" holes.
C14832—Shpg. wt. 8 oz. 36¢
Your Cost Per Box

Snap-in Trimouts



Used to fasten dial scales, loop antennas and backs on plastic cabinets, etc. 30 Asst.
C14839—Your Cost 24¢

Radio Service Shop HARDWARE



Nickel Plated Machine Screws

Stock No.	Length	Gross
C14750	1/4"	35c
C14751	1/2"	36c
C14752	3/4"	43c
C14753	1"	50c
C14754	1 1/4"	58c
8-32 Round Head Screws		
C14755	1/4"	48c
C14756	1/2"	52c
6-32 Flat Head Machine Screws		
C14760	1/4"	36c
C14761	1/2"	37c
C14762	3/4"	42c
C14763	1"	48c
C14764	1 1/4"	61c



Soldering Lugs

\$3.06 Per Thousand
C14812—No. 1. C14813—No. 2.
C14814—No. 3, solderless type.
C14816—No. 4, 3/8" long.
C14818—No. 5, 1/2" long.
Your Cost per 100, 34¢
Any Type Lug.....

Tapered Lugs

Fits over all screws up to No. 10; shank fits banana plugs. 1 1/2" long, 1/8" wide. Cut for easy soldering.
C12954—Per Dozen 44¢

Heavy Duty Spade Lugs

For battery terminals, etc., 1" long. No. 10 slot. 100 For 69¢.
C14912—Your Cost 8¢ per 10.....

Colored Grommets

Hard insulating composition; with knurled nut; in red or black. For instruments, etc.

Red	Black	Hole Diam.	L.
C14688	C14689	1/4"	1/2"
Your Cost Per Doz. 60¢			
C14690	C14691	3/8"	3/4"
Your Cost Per Doz. \$1.06			
C14692	C14693	1/2"	5/8"
C14694	C14695	5/8"	3/4"
Your Cost Per Doz. 93¢			
Either Size.....			

Rubber Grommets

Insulate holes in metal panels, chassis, electrical appliances, etc.

Stock No.	Fits Inside Hole	Per Doz.	Per 100
C14765	1/4"	9c	60c
C14766	3/8"	16c	65c
C14768	1/2"	20c	70c
C14769	5/8"	22c	75c

Rubber Grommet Kits

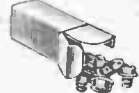

Available in two assortments—kit "A" contains 12 assorted grommets in 4 sizes—1/8" to 3/4" to 1/2". Kit "B" contains 30 assorted grommets in 4 standard sizes—1/8" to 1/2".
C14794—Assort. "A" 21¢
Your Cost
C14795—Assort. "B" 43¢
Your Cost

Ornamental Top Antique Finished Machine Screws

No.	Size	Len.	Doz.	Gr. Lots
C14680	6-32	1/4"	9c	95c
C14681	6-32	1/2"	10c	\$1.02
C14682	6-32	1 1/4"	11c	1.18

Round Head Wood Screws

Stock No.	Size	Length	Gross
C14780	4	1/4"	39c
C14781	5	1/2"	41c
C14782	5	3/4"	45c
C14783	5	1"	48c

Hex Nuts, Knurled Nuts, Washers, Popular Sizes

C14804	6-32x 1/4" hex. nuts.	Per gross 45¢
C14805	8-32x 1/4" hex. nuts.	Per gross 45¢
C14806	6-32x 1/2" hex. nuts.	Per gross 45¢
C14807	8-32x 1/2" hex. nuts.	Per gross 45¢
C14803	10-32x 3/8" hex. nuts.	Per gross 54¢
C14808	6-32x 1/4" knurled nuts.	Per 100 \$1.10
C14809	No. 6 washers.	
C14810	No. 8 washers.	
		Per 100 16¢

Locking Washers

C14758—#6 Lock washers
C14759—#8 Lock washers
 Either type
 Envelopes of 25... **6¢**
 100 For... **20c**

Knob Set Screws

These headless set screws are case hardened. For radio knobs, couplings, etc.
C14786—1/4"x6-32 C14787—1/4"x8-32
C14788—1/4"x6-32 C14789—1/4"x8-32
Any Size Above, 18¢
10 For.....
50 For.....75c

Self-Tapping Screw Assortment

Forty of the most commonly used sizes in modern receivers. Use no nuts, merely start hole and drive through. Used in many standard receivers.
C14687—Box of 40. 35¢
Your Cost

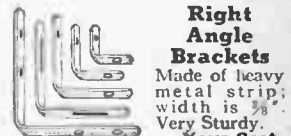

Right Angle Brackets

Made of heavy metal strip; width is 3/8". Very Sturdy.
Your Cost

Stock No.	Size	Ea. For 10
C14895	1/2"x 1/2"	1c
C14896	1/2"x 3/8"	1 1/2c
C14897	1"x 1"	2 1/2c
C14898	1 1/2"x 1 1/2"	3c
C14899	1 1/2"x 1 1/2"	3 1/2c

✓ Check THESE VALUES! QUANTITIES LIMITED!



GE PYRANOL Condensers

(A) Famous make of oil filled and impregnated, hermetically sealed capacitors with stud type terminals on glazed ceramic insulators. Complete with terminals and mounting hardware. Ideal for commercial, amateur, manufacturing and experimental uses.

Stock No.	Fig.	Cap. Mfd.	W.V. D.C.	Dimensions, In.	Your Cost
5B3229	A	4	1500	3 3/4 x 1 1/4 x 4 3/8	\$1.95
5B3228	A	2	1000	5 x 1 3/4 x 1	.79
5B3236	A	1	1000	1 3/4 x 1 x 2 1/4	.59

4 Mfd. 600 Volt Oil Type Capacitor

(B) Oil filled and impregnated! Mounting is through a single hole to clear the sturdy 3/4x16 threads per inch threaded bakelite neck. The two key-ways in the bakelite cover are locked in corresponding notches. The extruded metal container is spun down on a synthetic rubber sealing gasket. Provides a 100% hermetic seal and a strong mechanical bond between container and cover. Size 4 1/2 x 1 1/2". 4 mfd. 600 working volts, DC.

5B3164—Your Cost..... **59¢**

TOBE Plug-In Capacitor Type PT-SC-11

(C) Filtermite. Passes all required Army and Navy immersion tests. Low power factor. Capacity: 8-8 mfd. Resistance: 2000 megohms per mfd. Voltage: 600 volts DC working. Tested at 1800 volts DC. 2 1/2" x 2 1/2" x 3 3/4". 2 lbs. C2330—4 prong.

Each..... **\$1.95**

600 Volt Oil Filled Condenser

(D) Cornell-Dubilier type TIL 6020, 2 mfd. at 600 volts DC wkg. Size, 1 x 1 3/4 x 2 1/8". Less mtg. bracket.

5B3014—Each..... **59¢**

Similar to above but 6 mfd. Size: 5 1/2 x 2 1/2 x 1 1/4". 5B3209—Your Cost..... **69¢**

Standard Brand Condensers—Priced Low

Servicemen! Extra special values in condensers. These prices give you over 60% discount from list. Concord offers the opportunity to stock all popular sizes of condensers at tremendous savings. A condenser for every service need. Stock up now on all sizes. All brand new guaranteed nationally known makes of condensers. Order today.

Stock No.	Cap.	W. V. D. C.	Price Each	Price—Lots of 10 Each
X-100	10	25	\$0.30	\$0.27
X-101	25	25	.34	.31
X-102	50	25	.40	.36
X-103	10	50	.32	.29
X-104	20	50	.34	.31
X-105	25	50	.36	.33
X-106	50	50	.42	.38
X-107	8	150	.32	.29
X-108	12	150	.34	.31
X-109	16	150	.36	.33
X-110	20	150	.38	.34
X-111	30	150	.40	.36
X-112	40	150	.44	.40
X-113	4	250	.32	.29
X-114	12	250	.40	.36
X-115	16	250	.44	.40
X-116	20	250	.48	.44
X-117	8	350	.36	.33
X-118	12	350	.44	.40
X-119	16	350	.50	.45
X-120	24	350	.54	.49
X-121	4	450	.36	.33
X-122	8	450	.38	.34
X-123	10	450	.42	.38
X-124	12	450	.46	.42
X-125	16	450	.54	.49
X-126	20	450	.60	.54
X-127	16	500	.80	.72
X-128	5-5	50	.44	.40
X-129	10-10	50	.46	.42
X-130	8-8	150	.46	.42
X-131	8-16	150	.48	.44
X-132	20-20	150	.52	.47
X-133	8-8	200	.50	.45
X-134	8-16	200	.52	.47
X-135	12-12	200	.52	.47
X-136	16-16	200	.60	.54
X-137	16-16	250	.68	.61
X-138	8-8	450	.68	.61
X-139	8-16	450	.80	.72

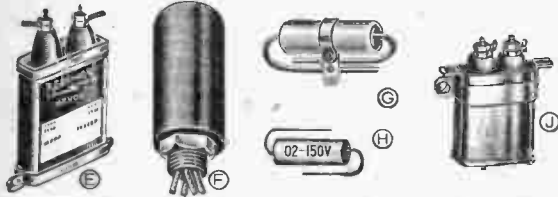

.25 Mfd. 1000 Volt Condenser

(E) A light-weight dependable unit furnished with mounting bracket. Oil-filled and impregnated. Porcelain stand-off insulators fitted with locknuts and soldering lugs. Overall size: 3 x 1 3/4 x 1".

C2316—Each..... **29¢**

Plastic Cased Dry Electrolytics

(F) Highly efficient electrolytic condensers encased in gleaming plastic. Designed for inverted mounting. All are 100% moisture proof and will withstand extremes of heat. Insulated wire leads for direct connection. All are rated at 450 volts d.c. wkg.; 600 volts peak. 1 1/2" d. x 3 1/2" h. with palnut.

Stock No.	Cap. Mfd.	Your Cost Each
C2384	10	\$0.69
C2385	12	.76
C2386	16	.85
C2389	20	.92
C2390	24	.95
C2393	35	1.09

Oil Filled Paper Condensers

Stock No.	Type	Cap. Mfd.	D.C.	Size	W.V.	Di.	L.	Your Cost
5B3213	D	.05	600	1 1/2 x 1 3/4	9c			
5B3214	D*	.05	600	1 3/4 x 1 3/4	9c			

*Same as 5B3213 less mounting bracket.

.5 Mfd., 1500 Volt D.C. Condenser

(J) Metal encased. Stand-off insulator terminals with 8-32 screw terminals with lugs. Complete with mounting hardware. Overall size: 3 1/4 x 1 1/4 x 1".

5B2968—Your Cost..... **49¢**

Midget Paper Condensers

(H) For Hearing Aids and Personal Radios. Miniature type paper capacitors with ends sealed in bakelite resinoid. Will not melt at 100 degrees centigrade. For use up to 95 per cent humidity. Good leakage resistance, and leads will not pull out at high temperatures. Non-inductive, pre-tinned copper wire leads. These units are conservatively rated at 150 volts. All sizes are plus or minus 1/8%.

Stock No.	Cap. Mfd.	Size L.x.D.	Your Cost
C3192	.001	3/8 x 3/8	EA. 10¢
C3159	.002	3/8 x 3/8	
C3160	.005	3/8 x 3/8	
C3161	.006	3/8 x 3/8	
C3193	.01	3/8 x 3/8	
C3194	.02	3/8 x 3/8	
C3162	.05	3/8 x 3/8	11c
C3163	.1	3/8 x 3/8	12c

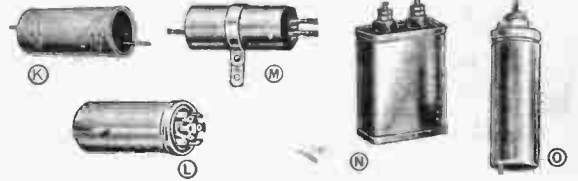

SPECIAL VALUE Condensers

A variety of capacitors for every purpose, at give away prices. Exceptional opportunity for radio servicemen, experimenters and amateurs to have available a stock of popular condensers at money saving values. Midget dry electrolytic types will handle any job requiring an electrolytic capacitor. Polarity clearly indicated. Bare wire leads. Easily replace larger capacitors. Can types hermetically sealed in spun metal cans with spade terminals and mounting lugs.

No.	Type	Mfd.	WV	Size	Each
5B3220	K	8	450	1 1/2 x 2 1/2	27c
5B3221	K	8-8	450	1 x 2 1/2	45c
C3156	K	10	450	1 3/8 x 2 1/8	23c
C3157	K	10-10	450	1 x 3 1/4	35c
5B3222	K	16	450	7/8 x 3	35c
5B3223	K	20	150	1 1/2 x 2	25c
C3155	K	20	250	3/4 x 2 1/2	35c
5B3224	M	20-20	150	3/4 x 2 1/2	37c
C3156	K	40	150	3/4 x 2 1/2	29c
C3158	K	40	450	1 1/2 x 3 1/2	49c
5B3226	M	50-30	150	1 1/2 x 3	38c
5B3219	L	16	500	1 1/2 x 2	49c
5B3216	L	100	50	1 x 2 1/2	14c
5B3053	L	100-100-50-20	50	1 1/4 x 3	17c

Oil Filled Capacitor

(N) Connectors mounted on porcelain stand-off insulators. 1 mfd at 1000 W.V. DC. Steel case 1 1/2 x 1 x 2 1/8". Bracket with 2 1/4" mounting centers.

5B3237—Your Cost..... **59¢**

Oil Impregnated Paper Condenser

(O) Cylindrical type can, solder lug connector. 2 mfd at 600 W.V. DC. Size: 1 1/2 dia. x 2 3/4".

5B3238—Your Cost..... **29¢**

PM and Dynamic SPEAKERS EVERY SIZE

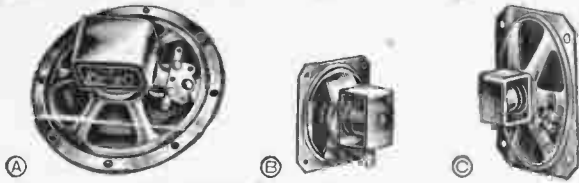

5" ALNICO V P.M. Speaker

(A) Uses the new Alnico V magnet that provides maximum performance with minimum weight. Widely used in AC-DC radios, record players, inter-office and auto radios. High conversion factor. Voice coil terminals conveniently placed on transformer mounting bracket. Transformer not furnished. Normal wattage 3, peak wattage 4 1/2. V.C. impedance 3.2 ohms, depth 2 1/4". Shpg. wt., 1 1/4 lbs. **\$1.57**
5B7009—Your Cost, Each

3 1/2" ALNICO 3 Speaker

(B) 3 1/2" square mounting PM speaker with heavy Alnico magnet. Dust-proof spider and voice coil. Excellent for intercom systems, small radios, portable record players. Voice coil impedance 8 ohms. Will handle 2 watts with ease. Requires only 2" behind mounting panel. Shpg. wt., 1 lb. **\$1.49**
5B7011—Your Cost

ALNICO V Oval Speaker

(C) 4x6" rectangular mount with 3 1/2"x4 1/2" mounting centers. Utilizes Alnico V magnet of 1.47 oz. wt. Spider and voice coil dust proofed. 2 1/2" deep. Voice coil terminals on transformer mounting. Less transformer. Weighs only 9 oz. Ideal for portable equipment or requirements where quality reproduction and light weight are desired. Voice coil 3-4 ohms impedance. Rated 3 watts normal, 4 1/2 watts peak. **\$1.65**
5B7012—Your Cost



Alnico "V" 12" PM Dynamic Speaker

Excellent constructed 12" PM dynamic speaker with Alnico V permanent magnet. Magnet weight of 6.8 oz. is equal to 20 oz. of conventional magnets. 1" voice coil with 6.8 ohms impedance. Capacity is 14 to 18 watts. Dust-proof spider and voice coil construction. For all general applications such as FM and AM receivers, fine phonographs broadcast and recording monitoring, public address. Also excellent for replacement purposes. **\$5.95**
5B7010—Your Cost

MIDGET PM SPEAKERS

Compact, lightweight speakers that employ efficient permanent magnets. Ideal for call and paging systems, hearing aids, intercommunicators, 3 1/2" model has 3 ohm voice coil. 5" model has round frame, others square. Less transformer. Shpg. wt. each, 1 1/2 lbs.

No.	Dia.	Watts	Ea.	No.	Dia.	Watts	Ea.
C19123	3 1/2"	2	\$1.30	C19113	5"	2	\$1.45
C19132	3 1/2"	3	1.40	C19114	5"	3	1.49
C19112	4"	3	1.45				

6" PM Speaker

High quality permanent magnet all purpose 6" speaker. Matches in sensitivity a comparable field coil type. Has high permeability magnet. One-piece seamless cone, plated metal frame. Voice coil impedance 3.2 ohms. 6" diameter, V.C. Dia. 3/4", normal wattage 4, peak 6. Depth, 2 1/4". Less output transformer. Shpg. wt., 1.3 lbs. **\$1.89**
X144—Your Cost

8" PM Speaker

High quality PM speaker with high permeability magnet, and one piece seamless cone. Voice coil impedance 6-8 ohms, dia. 3/4". Normal 5 watts, peak 8 watts. Depth 3 1/4". Shpg. wt., 4 lbs. Less output transformer. Ideal for radio set replacement and light P.A. work. **\$2.90**
X145—Your Cost

3 1/2" Field Coil Speaker

A quality speaker for general replacement purposes on call systems, hearing aids and magnet radios. Has 450 ohm field coil. Flat response, when properly baffled, from 100 to 4500 c.p.s. Formed 1 piece cone. Less transformer. Shpg. wt., 3 lbs. **\$1.44**
X146—Your Cost

4" Field Coil Speaker

Has a practically flat response, when properly baffled, covering from 100 to 4500 c.p.s. Formed one piece cones. For general replacement purposes on call systems, hearing aids, midjet radios. Also good for light public address work. 450 ohms field. Shpg. wt., 3 lbs. Less transformer. **\$1.49**
X147—Your Cost

5" Dynamic Speaker

5" dynamic speaker for general replacement in radio receivers, call and intercommunication systems. Also used for light public address work. When properly baffled has a practically flat response covering from 100 to 4500 c.p.s. Formed one piece cones. 3000 ohm field. Less transformer. Shpg. wt., 3 lbs. **\$1.59**
X148—Your Cost

225 Ohm 5" Dynamic Speaker

For replacement in radio receivers, intercommunication and paging systems. 225 ohm 5" dynamic speaker with extra heavy pot, hum bucking coil and double shielded Output transformer to match output impedance of 50L6. Excellent for voice and music. **\$1.65**
5B7013—Your Cost

Handy Terminal Strip Kit



Kit of 10 assorted. Handy assortment with from 2 to 28 terminals. High quality phenolic insulation with either screw or solder terminals. Mounting holes or brackets provided on each strip. **\$29¢**
5B6975—Your Cost

Vitreous and Cement Coated Resistor Kit

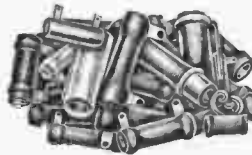

Assortment of 20 vitreous enamel and cement coated wire wound resistors with wattage ratings from 5 watt to 25 watts. Wide assortment of ohmage values. **\$1.79**
5B245—Your Cost

Voltage Divider Kit

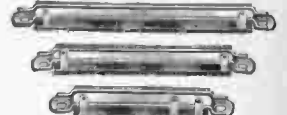

Rated at 2.5 watts in free air—10 watts when mounted on chassis. Metal mounting strap conducts heat from unit without shorting or grounding. Contains 10 wire wound resistors with moulded bakelite cases and metal mounting straps. Resistance values: 5.45, 6, 100/2M, 250, 2500, and 30M ohms. A Real value! **98¢**
5B244—Your Cost

Kit of 100 Micamold Mica Condensers



Kit of popular size bakelite mica capacitors for servicemen and amateurs. Unmarked, but all guaranteed perfect. High quality units at an unusually low price. Capacities range from .000005 mfd. to .0005 mfd. **89¢**
C3995—Your Cost

Kit of 10 Moulded Paper Condensers

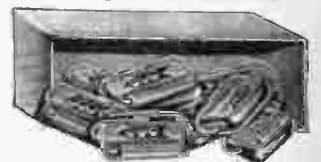

Popular sizes of moulded bakelite cased wax impregnated paper condensers, with axial wire leads. All have RMA color code, and all guaranteed perfect. Highest quality units made by leading manufacturers. Capacitance from .006 mfd. to 2 mid., 200 to 600 volts. **79¢**
5B6976—Your Cost

TRIMMER CONDENSER ASSORTMENT

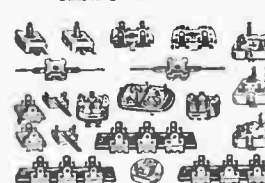

20 Assorted Trimmers and Padders in regularly used capacities. Majority are ceramic, standard types. **59¢**
C10203—Your Cost

IF Transformer

High gain permeability tuned IF transformer. 375 KC normal peak, but gives verysatisfactory operation at 455 KC peak. Has screwdriver slot adjustments, one on top and one on bottom. 5 solder lug terminals on bottom. Ideal for replacement use and experimenters. Small size, only 1 1/2"x 1 1/2"x 2 1/4" high. 2 spade mounting studs No. 6-32x 3/8" long on 1 3/8" mtg. ctrs. A real value! **39¢**
5B5129—Your Cost, Ea.
10 for \$3.50

OUTSTANDING VALUES! *Stock Up NOW!*

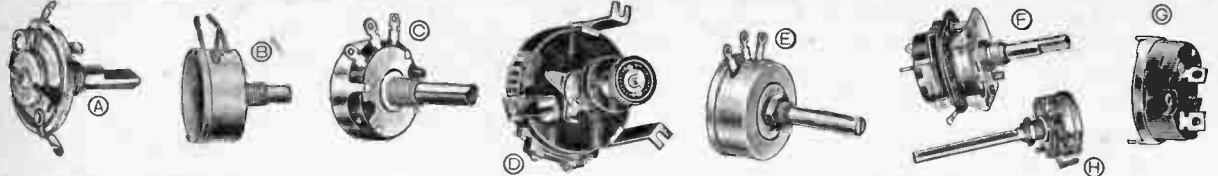

"L" Pad

(A) Nationally known wire wound "L" Pad for replacement or general purpose use. Standard $\frac{3}{8}$ "-32 threaded mounting bushings, $\frac{1}{4}$ " dia. shafts. 8-8 ohms, 4 watts, $1\frac{1}{2}$ " dia. x $\frac{1}{2}$ " depth. Shaft length 1".
C6337—Your Cost, Each 12¢
 Lots of 10 each 10c

Wire Wound Volume Control

(B) Exceptional value in nationally known standard make of smooth acting wire wound 1000 ohm, 4 watt control. Standard $\frac{3}{8}$ "-32 threaded mounting bushings and $\frac{1}{4}$ " dia. shafts. Ideal for replacement and general purpose use. Body dia. $1\frac{1}{8}$ " x $\frac{3}{8}$ " deep. Shaft length $\frac{3}{8}$ ".
5B2096—Your Cost, Each 24¢
 Lots of 10 19c

Potentiometer

(C) Nationally known, fully enclosed smooth action carbon type control for replacement or general purpose use. Standard $\frac{3}{8}$ "-32 threaded mounting bushing and solder lug terminal. 13,000 ohms $1\frac{1}{8}$ " dia. x $\frac{1}{2}$ " deep. Shaft dia. $\frac{1}{4}$ ", length $1\frac{1}{2}$ ".
C8158—Your Cost, Each 10¢
 Lots of 10 each 8c

Motor Speed Control

(D) Money Saving value on wire wound control. Designed for permanent smooth close control. Ceramic and metal construction permits operation under heavy loads and insures proper heat dissipation. Single hole mounted by $\frac{3}{8}$ "-32 threaded bushing, with solder lug terminals, and $\frac{1}{4}$ " dia. Shaft with knob. 12.5 ohms, 500 watts. Body $6\frac{3}{4}$ " dia., $2\frac{3}{4}$ " deep, $4\frac{3}{4}$ " shaft.
5B7080—Your Cost, Each \$3.95
 Lots of 10, each \$3.50

Volume Controls

(E) Compact $1\frac{1}{4}$ " dia. carbon volume controls for general purpose use, 1 Megohm, less switch. $\frac{1}{4}$ " shaft $1\frac{1}{2}$ " long. Potentiometer taper. Requires $\frac{1}{4}$ " behind panel.
5B2041—Your Cost 19¢
 10 for \$1.70
 $\frac{1}{2}$ Megohm, with on-off switch. Audio taper $\frac{1}{4}$ " shaft $2\frac{1}{2}$ " long. Requires $1\frac{1}{2}$ " depth.
5B2103—Your Cost 43c
 10 for \$3.90
 1 Megohm with on-off switch. Audio taper. $\frac{1}{4}$ " shaft $2\frac{1}{2}$ " long. Requires $1\frac{1}{2}$ " behind panel.
5B2104—Your Cost 43c
 10 for \$3.90

Radio Phono Selector Switch

(F) Nationally known switch for replacement or general purpose use. 3 position 10 point stator. AC switch closed in 3rd position extreme clockwise. Standard $\frac{3}{8}$ "-32 threaded bushing. Shaft $\frac{1}{4}$ " dia 1" length.
5B4172—Your Cost 29¢

1.5 Meg. Volume Controls

(H) A compact efficient and long life volume control. Consistent quiet service is assured in all climates by means of an exclusive stabilized element. Dia. $1\frac{1}{8}$ ", $\frac{1}{4}$ " shaft, 2" long, $\frac{3}{8}$ " bushing with nut. 1.5 megohm control. Audio shunt, AVC taper.
5B2105—Your Cost 29¢

SPST Volume Control Switch

(G) SPST cover plate switch for use with above volume control.
5B2106—Your Cost 15¢

Midget Knife Switches

(L) Panel mounting. Has black Bakelite base, plated metal parts. $1\frac{1}{4}$ " long, $1\frac{1}{2}$ " wide. With mtg. nuts. Type DPST.
C16845— 25¢

Push Button Switch

(P) Six button switch, one button three pole double throw, rest are double pole, single throw, non-shorting. Less knobs.
C9582 29¢

SPST Locking Type Switch

(N) For use on automatic record changers or as a limit switch. Cam with roller actuates switch, which then locks in closed position, and circuit can be opened by light pressure on retaining dog. Handles approximately 3 amps. at 125 volts. Normally open.
C12597—Your Cost 7¢

Special Value Resistor Kit

Kit of 100 assorted resistors, $\frac{1}{2}$ to 2 watt. All R.M.A. color coded.
5B155—Your Cost 89¢

75 Watt 20,000 Ohm Adjustable Resistor

(T) Wire wound unit with adjustable slide. Nicrome resistance wire wound on ceramic tube with glazed vitreous enamel coating, and lug terminals. $6\frac{1}{2}$ " long x $\frac{3}{4}$ " OD x $\frac{1}{2}$ " ID.
5B131—Your Cost 59¢

75 Watt 30,000 Ohm Variable Resistor

(W) Vitreous enamel coated. Adjustable taps have small contact buttons so several may be used without shorting out much resistance. Brackets and one slider furnished.
5B132—Your Cost 69¢

"Koolohm" Fixed Resistors

(Y) Insulation has high dielectric strength, withstands red heat and is impervious to moisture.

6 Pole 3 Position Ceramic Gang Switch

(K) Non-shorting type, with all contacts, lugs and wipers heavily silver plated. All other metal parts cadmium plated. Steatite insulation used throughout, for high voltage and RF switching. Has standard $\frac{3}{8}$ " threaded bushing, and $\frac{1}{4}$ " shaft extending $1\frac{1}{2}$ ".
C5922—Your Cost, Each 39¢

Ceramic Insulated Selector Switches

(M) Five position two gang selector switch with total of 32 contacts. Can be used as a meter switch where several circuits are supplied by a common source or as a band switch to short out unused coils. Standard $\frac{3}{8}$ " bushing with lock washer and nut. $\frac{1}{4}$ " shaft, $\frac{3}{8}$ " long. A good item for any maintenance or serviceman.
5B4035—Your Cost 29¢

$\frac{1}{2}$ & 1 Watt R.M.A. Carbon Resistors

(R) Here's another **CONCORD EXCLUSIVE** serviceman's offer that helps you to build profits! Our tremendous buying power makes this offer possible—stock up now and save! All are R.M.A. coded and held to acceptable tolerances. Specify stock number of type and resistance.

Ohms	Ohms	Ohms	Ohms	Ohms	Ohms	Ohms
100	900	6000	17500	70000	200000	$1\frac{1}{2}$ Meg.
150	1000	7500	20000	75000	250000	2 Meg.
200	1500	10000	25000	80000	300000	$2\frac{1}{2}$ Meg.
250	2000	12000	30000	90000	400000	3 Meg.
500	2500	12500	35000	100000	500000	5 Meg.
600	3000	13000	50000	125000	750000	
750	5000	15000	60000	150000	1 Meg.	

C5239— $\frac{1}{2}$ -Watt Size } 2 1/2¢ Ea. For \$2.15
C5240—1-Watt Size } 100
Kit of 100 Resistors—An assortment of 100 popular carbon resistors. Contains approximately 50 1-watt, 25 $\frac{1}{2}$ -watt and 25 $\frac{1}{4}$ -watt resistors. All standard RMA color coded. Shpg. wt. 2 lbs.
C3816—Kit of 100. Specially Priced \$1.50

2-Watt Carbon Resistors

(S) Heavy-duty carbon resistors, absolutely moisture proof. RMA color coded for easy identification; made of the finest material and workmanship. **Guaranteed accuracy, 10% plus or minus.** The average are within 5%. Resistance values will not vary at normal voltage. Ideal for replacement across small voltage divider sections, bleeders, etc. 2" L. x $\frac{1}{2}$ " O.D.

Ohms	Stock No.	Ohms	Stock No.	Ohms	Stock No.	Ohms	Stock No.
200	C4450	2500	C4460	12000	C4470	125000	C4482
500	C4452	3000	C4461	17000	C4472	150000	C4483
600	C4453	3500	C4462	25000	C4474	200000	C4484
700	C4454	4000	C4463	30000	C4475	250000	C4485
800	C4455	6000	C4465	40000	C4478	300000	C4486
1000	C4456	7000	C4466	60000	C4476	500000	C4487
1250	C4457	7500	C4467	70000	C4479		
1500	C4458	8000	C4468	75000	C4480		
2000	C4459	10000	C4469	100000	C4481		

Your Cost, Each 54c **25 For \$4.86**
10 For 6¢

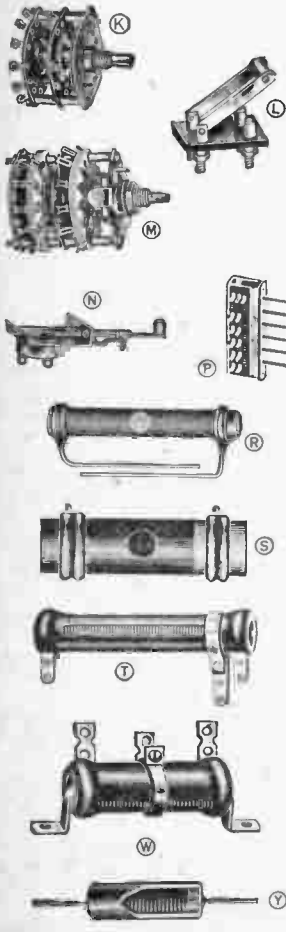

SPECIAL VALUES!



Facsimile Broadcast Receiver and Printer

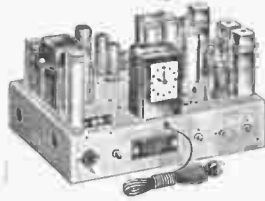
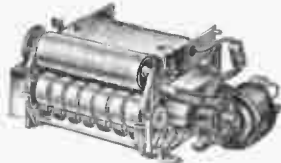

- ★Five-Tube High Fidelity Broadcast Receiver
- ★Telechron Time Switch Clock
- ★Worm Drive Synchronous Motor
- ★Three-Tube Facsimile Printer and Amplifier

Complete Set Consists of Two Principal Units—

Recording Unit driven by a worm gear and synchronous motor and operated thru impulses from a special three tube recording head amplifier. Utilizes carbon paper in contact with white paper as a recording medium.

Receiver is a conventional 5-tube high-fidelity superheterodyne with the audio output feeding the recording amplifier. Easily modified to power a large PM speaker with plenty of reserve. Receiver as it stands, covers the entire broadcast band in two ranges of 540-1160 KC and 770-1550 KC.

Telechron Time Switch Clock turns set on at any predetermined hour, permits it to operate for any desired length of time, up to six hours, then turns it off, all automatically. Can be used for numerous other timing applications as well. Entire complement is housed in a high quality mahogany cabinet with closing lid in the style of the latest radios. Size of cabinet (13" deep, 19" wide, 21" high) adapts it to construction of modern record player or record changer with built-in radio. For 105-125 Volts, 60 cycle operation. Shpg. wt. 100 lbs. The many fine, precision units included in this equipment at the price shown, easily make it the outstanding buy of the year! **The value of the parts alone is many times this low cost!**



Eleven-Tube Radar Unit

GREAT PARTS VALUE! Brand new APA-1 radar indicating gear designed to operate with any other aircraft radar or IFF equipment. Amplifier contains 11 tubes: 2x2/879, 6116, 6G6G, 6X5GT, 7-6SN7GT, resistors, condensers, etc.; black wrinkle metal cabinet measures 7 $\frac{1}{4}$ "x12 $\frac{1}{4}$ "x9 $\frac{3}{8}$ "; has shock mounting. Control unit in separate cabinet has switches, potentiometers, connectors, etc. Scope indicator with 3BP1 cathode ray tube enclosed in metal shield; has rubber-tipped metal visor and 6 feet of 11-conductor shielded cable. Units are in original packing cases, complete with operating handbook.

5B9549—
Your Cost

\$19.95

Xtal Frequency Standard

The famous MCW-CFI unit of the AN/ART-13A Transmitter. This unique sub assembly utilizes one 12SL7GT twin triode as a combination 200KC calibration oscillator and frequency tripler, one 12SA7 tube as a converter and one 12SL7GT tube as a signal detector and MCW audio oscillator supplying a 1,000 cycle audio note. The CFI unit employs a regenerative frequency divider and multiplier circuit to obtain a 50 KC fundamental and harmonics, incorporating a 200 KC crystal (not supplied) as the controlling standard and will yield from 50 KC to 18 megacycles. This unit can be adapted into an excellent Frequency Meter, range 50 KC to 18 megacycles by adding an external power supply and VFO. Chassis measures overall, including tubes, 5" high, 5 $\frac{1}{2}$ " long, 3 $\frac{1}{2}$ " wide. Shipped with tubes and schematic.

5B9548—
Your Cost

\$2.95

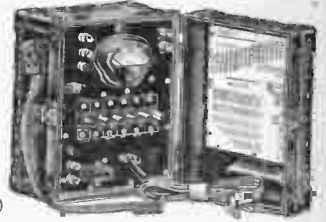

Marker Beacon Receiver

BC-1023-A is a regulation marker beacon receiver designed for reception of modulated signals on the 75-MC band authorized by the FCC; variable tuning permits coverage of 62-80 MC without circuit changes. Output of the receiver usually is used to flash an indicator lamp on the pilot's instrument panel and no adjustments are necessary during operation; simply turn the set on. Relay circuit in the set can be adapted to control external circuits, open doors, etc. Weight is only 3.4 pounds; dimensions are 5 $\frac{1}{2}$ "x5 $\frac{1}{2}$ "x3 $\frac{1}{2}$ ". BC-1023-A is housed in a handsome aluminum cabinet with a shock mounting. Units are new, in original cartons, and complete with tubes (1-6SQ7, 1-6U6GT, 1-6SC7, and 1-12SH7). Operates directly from any 12-14 VDC power source. Priced for quick sale to flyers, amateurs, and experimenters.

5B9547—

Your Cost

\$3.95

Wire Chief's Portable Test Set

A "must" for P. A. men. Use as a telephone set in connection with a handset. Use as DC voltmeter, 0-50V, 1000 ohms/V, 1% accurate. Use as ohmmeter. Use to check insulation resistance. Use to predict location of a break in a line by determining capacity between two wires or one wire and ground. Parts alone worth far more than price of entire set. Contains the voltmeter; six very good key switches (single-throw, two throw, spring-loaded, snap action; multiple contacts, perfect for amplifier panels, sound distribution panels, etc.); handcrank generator which puts out 90 volts at 16 to 20 cps; AC buzzer which requires only 5 ma; coils, terminals, etc. All contained in sturdy metal-bound wooden box with hinged lid, snap lock, and strap carrier, 11x9x7 $\frac{1}{2}$ ". New with complete instruction manual. Weight 7 lbs.

5B9565—

Your Cost

\$39.50

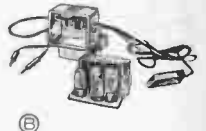

Transmitter Tuning Unit TU-10-B

Plug-in type variable frequency master oscillator and buffer tuning unit, frequency range 10,000 to 12,500 KC, housed in aluminum case with removable top and bottom covers. Contains 3 variable condensers. One 27-plate double spaced 100 mmf. Hammarlund condenser 3 $\frac{1}{4}$ " lg x 2 $\frac{3}{4}$ " wd x 1 $\frac{3}{4}$ " h, one 16-plate double spaced 35 mmf. Hammarlund condenser 3 $\frac{1}{4}$ " lg x 2 $\frac{3}{4}$ " wd x 2 $\frac{1}{2}$ " h, and one 7-plate double spaced 20 mmf. Hammarlund condenser 1 $\frac{3}{4}$ " lg x 3" wd x 1 $\frac{3}{4}$ " h; two 400 mmf. 2500 VDC low loss mica condensers Cornell-Dubilier 9H, one 400 mmf. 2500 VDC low loss silver mica temperature coefficient condenser Cornell-Dubilier 9LS; one tuning coil 9 turns 0.102" dia. tinned copper wire spaced 2 turns in. on ceramic coil form 2" dia. x 5" lg, one tuning coil 6 turns 0.102" dia. tinned copper wire space 2 turns in. on ceramic coil form 2" dia. x 5" lg, and tapped each turn; one Mycalex terminal strip $\frac{1}{4}$ " thk. x $\frac{1}{4}$ " wd x 12 $\frac{1}{2}$ " lg with 10 banana jacks. Front panel has one right angle 50 to 1 vernier 180 deg. rotation dial with lock, one straight 5 to 1 vernier 180 deg. rotation dial with lock, one heavy duty RF ceramic insulated SP61 rotary switch, and calibration chart. All variable condensers and coil forms mounted on ceramic stand-off insulators. Ideal as basic unit for high power transmitter exciter unit without alteration, or component parts may be dismantled for other uses. Black finish front panel, rear case natural aluminum finish. Size: 7 $\frac{1}{2}$ "x16 $\frac{1}{4}$ "x8 $\frac{3}{4}$ ".

5B9542—

Your Cost

\$1.95

Interphone Pre-Amplifier

Compact resistance coupled pre-amp which operates from an external power supply. Incorporates a 6SL7GT twin triode, 28D7 dual beam power amplifier, microphone matching transformer, filters plugs, sockets, and relay, all wired ready to operate, from a 28 VDC source. Supplied with press-to-talk switch on a four foot rubber covered cable, shielded leads, PL-68 three circuit plug and PL-55 two circuit plug. Housed in an aluminum case 5" long, 3 $\frac{1}{2}$ " high, 3 $\frac{1}{4}$ " wide. Schematic inside cover. Shipped complete with tubes.

5B9566—

Your Cost

\$1.89

TRANSFORMERS & REACTORS



A

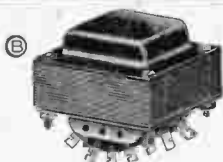

B

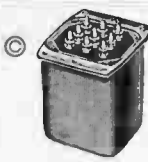

C

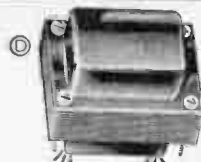

D



E

PLATE — FILAMENT — POWER TRANSFORMERS

PLATE TRANSFORMER

© 117/120 V. 60 cycle primary; secondary 850 V. CT at 200 ma. Fully shielded, horizontal mounting. Color coded leads; primary: red common, black 117 V., and brown-black 120 V. Secondary: brown High Voltage, and brown-yellow High Voltage CT. Size: $4\frac{1}{2} \times 3\frac{3}{4} \times 3\frac{3}{4}$ " high. 4 mounting Studs on $3 \times 3\frac{3}{4}$ " mounting centers. **\$2.95**
5B5065—Your Cost.....

Hi-Voltage Plate Transformer

© Primary 115 and 230 V, 50/60 cy. Sec. 1100 V CT at 212 ma. Fully enclosed grey steel case with 6 stud terminals on stand-off insulators through bottom. Size: $7\frac{3}{8} \times 5 \times 5\frac{7}{8}$ ". 6 mounting holes on $6 \times 2\frac{1}{8}$ " mounting centers. **\$3.95**
5B6556—Your Cost.....

Hi-Voltage Plate Transformer

© Primary 117 volts 60 cycles. Secondary 1080 volts CT at 250 ma. Fully enclosed black finish metal case, with 12" long RMA color coded leads. Size: $3\frac{1}{8} \times 4\frac{1}{4} \times 4\frac{1}{8}$ ". 4 slotted mounting holes on $3 \times 3\frac{3}{4}$ " centers. **\$4.95**
5B6563—Your Cost.....

Power Transformer

© Special value transformers Conform to RMA specifications. Primary 117 v. 60 cycles. Secondary outputs 700 v.c.t. at 90 MA, 5 v at 3 amp., and 6.3 v at 3.5 amps. For 8 or 9 tube receivers and amplifiers. Two hole mounting with $2\frac{3}{4}$ " centers. Size: $3\frac{1}{8} \times 3\frac{3}{4} \times 3\frac{3}{8}$ ". Shpg. wt. 5 lbs. **\$2.65**
5B6569—Your Cost.....

Power Transformer, 2.5 V.

© High grade low-power unit made to RMA specs. Primary 105-120 V, 60 cy. Secondaries 650 V CT at 40 mils, 5 V, 2 amps., and 2.5 V CT at 4 amps. Mounting area $3 \times 2\frac{1}{4}$ ". Mtg. Ctrs. $2\frac{1}{2} \times 2$ ". Shpg. wt. 2 lbs. **98¢**
C1521—Your Cost.....

Extra Value Power Transformer

© Heavy-duty through-chassis mount, half-shell type power transformer for replacement or original installation. Pri. 117v, 60 cy. Sec's 700v CT at 120 ma, 5.0v at 3 amp., 6.3v CT at 3 amp. Mtg. area $2\frac{3}{8} \times 3\frac{3}{8}$ ". Height above chassis $2\frac{3}{4}$ ". Overall hgt. $3\frac{3}{4}$ ". Shpg. wt. 4.2 lbs. **\$2.95**
5B6565—Your Cost.....

Heavy Duty Power Transformer

© A first quality component. Meets all specifications of American Standards Approved Transformers. Primary 117V, 50/60 cy, electrostatically shielded. Secondaries 700 V CT at 200 ma, 5.0 V at 3 amps., and 6.3 V CT at 6 amps. $4\frac{1}{2}$ " H, $3\frac{3}{4}$ " W, $4"$ D. Mtg. centers $3\frac{3}{4} \times 3$ ". Wt. 7.1 lbs. **\$4.56**
C2074—Your Cost.....

Heavy Duty Power Transformer

© Fully cased and electrostatically shielded. Vertical mount. A super deluxe power XFMR designed to live up to specifications under the most strenuous operating conditions. Ideal for general replacement purposes. 115 volt 60 cycle AC. $4\frac{3}{8}$ " high. Secondaries 800 V CT at 200 ma, 5 V at 4 amps., 6.3 V CT at 5.5 amps. Mounting area $3\frac{3}{8} \times 3\frac{3}{4}$ ". Mtg. ctrs. $3\frac{3}{8} \times 2\frac{3}{4}$ ". Shpg. wt. 10 lbs. **\$5.26**
5B5041—Your Cost.....

Power Transformer

© Hermetically sealed well constructed power transformer, 115 VAC-60 cycle primary with 700 volt center tapped secondary at 150 ma dc and 5 volt at 2 amp and 6.3 volt C.T at 2.5 amp secondary windings. Porcelain insulated lugs—5000 volt insulation test. Overall dimensions $5\frac{1}{2}$ " high, $4\frac{1}{2}$ " wide, $3\frac{1}{2}$ " deep. A real heavy duty power transformer for radios and amplifiers. **\$3.95**
5B6566—Your Cost.....

Power Transformer

© Primary 117 volts 60 cycles. Secondary: No. 1—860 volts CT at 50 ma., No. 2—5 volts CT at 3 amps., No. 3—5 volts at 2 amps., No. 4—6.3 volts at 2 amps., No. 5—6.3 volts CT at 2 amps. Fully enclosed black finish metal case, with 12" long RMA color coded leads. Size: $3\frac{1}{2} \times 3\frac{3}{4} \times 3\frac{3}{8}$ ". 4 slotted mounting holes on $2\frac{1}{2} \times 2\frac{3}{4}$ " centers. Excellent for amplifiers, radios, and general replacement purposes. **\$1.95**
5B6562—Your Cost.....

Filament Transformer

© Primary 115 and 230 V, 50/60 cycles. Secondary 5 V CT at 6 amps. Fully enclosed grey finish steel case, with 6 stud terminals on stand-off insulators through bottom. Terminals 1-2-3 primary, 4-5-6 secondary. Size: $4\frac{1}{2} \times 3\frac{3}{4} \times 3\frac{3}{8}$ ". 6 mounting holes on $3\frac{1}{4} \times 1\frac{3}{8}$ " centers. **\$1.95**
5B6554—Your Cost.....

Filament Transformer

© Primary 115 V, 25 amps. at 60 cycles. Secondary 6.3 V, 3 amps. In hermetically sealed rectangular case. Length $3\frac{1}{8}$ " x width $2\frac{3}{4}$ " x height $4\frac{3}{8}$ ". Four studs for above chassis mounting. $1\frac{1}{2} \times 2\frac{1}{4}$ " mounting centers. Solder lug terminals mounted on porcelain stand-off insulators. **98¢**
5B6567—Your Cost.....

Filament Transformer

© An excellent filament transformer with 115 VAC 60 cycle primary. Sec. No. 1 (2.5V-10 amp). Sec. No. 2 (6.3V CT at 5.5 amp). Sec. No. 3 (6.3V CT at 1 amp.). Hermetically sealed with porcelain insulated lugs, 5000 volt insulation test. Overall dimensions $5\frac{1}{2}$ " high, $4\frac{1}{2}$ " long, $3\frac{3}{8}$ " wide. Fine for Hams and experimenters. **\$2.49**
5B6568—Your Cost.....



F



G



H

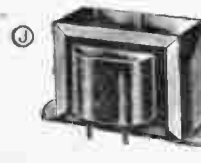

J



K

REPLACEMENT FILTER CHOKES

4 Henry, 300 Ma. Heavy Duty Choke

© 40 ohms DC resistance. Fully enclosed grey steel case with 2 stud terminals on stand-off insulators through bottom. Size: $5\frac{3}{4} \times 4\frac{3}{4} \times 3$ ". 6 mounting holes on $4\frac{1}{2} \times 1\frac{1}{4}$ " centers. **\$2.25**
5B6551—Your Cost.....

6 Henry, 50 Ma.

© 300 ohms DC resistance. Made to specifications of American Standards Approvals. $1\frac{1}{2}$ " H, $2\frac{3}{4}$ " W, $1\frac{1}{2}$ " D. Mounting centers $2\frac{1}{4}$ ". Shpg. wt., 1 lb. **68¢**
C2075—Your Cost.....

6 Henry, 150 Ma. Heavy-Duty Choke

© 100 ohms D.C. resistance. Fully enclosed grey steel case with 2 solder lug terminals on stand-off insulators through bottom. Size: $4 \times 3 \times 2\frac{3}{4}$ ". 6 mounting holes on $3\frac{1}{2} \times 1\frac{1}{2}$ " centers **\$1.89**
5B6553—Your Cost.....

Special Value! 10 Henry, 40 Ma. Choke

© 260 ohms D.C. resistance. Extremely compact, highly efficient choke particularly well suited for use in auto radio receivers and AC/DC radios. Also excellent filter for general receiver and amplifier use. Unshielded strap-type mounting. Size: $1\frac{1}{2} \times 1\frac{1}{4} \times 1\frac{1}{2}$ ". Shpg. wt., 1 lb. **39¢**
C1601—Your Cost.....

10 Henry, 50 Ma.

© 475 ohms D.C. resistance. Unshielded, strap type mounting. Efficient, small size, with wide variety of uses. Size: $2 \times 1\frac{1}{2} \times \frac{3}{4}$ ". Shpg. wt., 1 lb. **59¢**
5B5126—Your Cost.....

10 Henry, 110 Ma.

© 235 ohms D.C. resistance. Popular wide frame strap mounting Unshielded. Long flexible leads. Size: $2\frac{1}{2}$ " high, $3\frac{1}{8}$ " wide, $2\frac{1}{2}$ " deep. $3\frac{1}{2}$ " mounting centers. **98¢**
C1570—Your Cost.....

15 Henry, 50 Ma. Totally Enclosed Choke

© 120 ohms D.C. resistance. Fully shielded, strap type mounting. Compact, efficient, and has many uses. Size: $1\frac{1}{2} \times 2\frac{1}{4} \times \frac{3}{4}$ ". **69¢**
5B6550—Your Cost.....

20 Henry, 65 Ma.

© 220 ohms D.C. resistance. Fully enclosed black wrinkle finish case with solder lug terminals on bakelite panel through bottom. Size: $2 \times 2\frac{1}{2} \times 3$ ". 4 mounting holes on $1\frac{1}{2} \times 2$ " centers on top and bottom. **49¢**
5B5037—Your Cost.....

30 Henry, 50 Ma. Low Cost Per Henry

© 450 ohms D.C. resistance. Unshielded, strap type mounting. Ideal for replacement and experimental uses. Size: $2\frac{1}{2} \times 1\frac{1}{4} \times 2\frac{1}{2}$ ". Shpg. wt., 2 lbs. **73¢**
C246—Your Cost.....

IF YOU NEED TRANSFORMERS LOOK BELOW

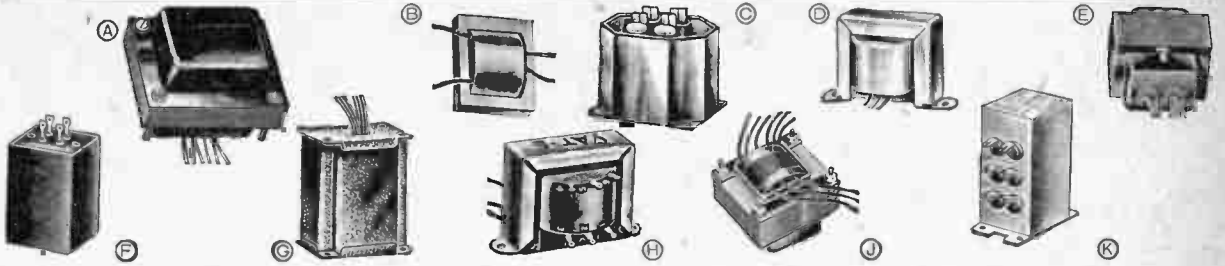

INPUT-INTERSTAGE-OUTPUT TRANSFORMERS

Input or Output Transformer

(A) Special transformer that would make a good input or output transformer. Center tapped primary, impedance 110,000 ohms. Primary current, 25 M.A. Secondary No. 1: 70, 150, and 275 ohms. Secondary No. 2: 310, and 2600 ohms. Half shell mount. Overall dimensions, 3"x2½"x3". With 6" flexible connecting leads. **5B5067—Your Cost..... 39¢**

Midget Input Transformer

(B) 6-8 ohms to single grid. Unshielded, with 4 color coded leads. For use with small PM dynamic speaker used as microphone. Size: 1½"x1½"x¼". **C5962—Your Cost..... 11¢**

Interstage Transformer

(C) Primary (1-2) 10,000 ohms, secondary (3-4) 100,000 ohms. Fully enclosed black finish octagon case with 4 numbered solder lug terminals on top. Size: 2"x1½"x1½". 4 mounting holes on 1½"x1½" centers. **5B5110—Your Cost..... 39¢**

Push-Pull Driver Transformer

(D) High quality driver transformer for push-pull phase inversion. Pri. impedance 10,000 ohms. Pri. current 35 ma. Secondary tapped for following ¼-secondary impedances and turns ratios pri. to ½ sec.: 2500 ohms, 1:1; 4400 ohms, 1.5:1; 10,000 ohms, 2:1. Core size ¾"x¾"x 2" H, 3½" W, 1½" D. Mtg. ctrs. 2½". Wt. 1.7 lbs. **C2079—Your Cost..... 98¢**

Tube to 200 Ohm Line Output Transformer

(E) 2500 ohm primary, 200 ohm secondary. Has colored leads—red, yellow and blue, primary. Black and yellow, secondary. Very compact construction, ideal for intercoms. Overall size: 1½"x¾"x1½". **5B5109—Your Cost..... 19¢**

Tube to 500 Ohm Line Output Transformer

(F) Primary 15,000 ohms, 10 ma.; secondary 500 ohms. Fully enclosed, hermetically sealed, with 4 solder lug terminals. For remote line, and pre-amplifiers. Size: 2¼"x1½"x1½". **5B5125—Your Cost..... 59¢**

Push-Pull to 500 Ohm Line Output Transformer

(G) 20,000 ohm primary CT, 8 ma. DC max. current. 500 ohm secondary CT. Frequency response flat ±1 db from 50 to 8000 cycles. Fully enclosed black crackle finish metal case, with 12" color coded leads out bottom. Size: 2"x2½"x2½". 4 mounting holes on top and bottom on 1½"x2" centers. **5B5680—Your Cost..... 1.59**

Single-Ended Output Transformer

(H) Primary, single tube 7,000 ohms 30 ma.; secondary 4 ohms. Unshielded strap type mounting with color coded leads. Size: 1½"x1½"x1½". 2 mounting holes on 2" centers. **C1612—Your Cost..... 45¢**

Universal Output

(I) 15 watts. For single or push-pull plates. With instruction sheet. Primary impedance 2500, 5000, 6500, 10,000, 13,000 ohms. 70 ma. Secondary 2, 4, 6, 8, 15 ohms. 2¼" H, 3½" W, 2½" D overall. Shpg. wt. 3 lbs. **C2082—Your Cost..... 1.19**

Universal Output

(J) 15 watts. Single or push-pull tubes to voice coil. Half shell type with 9 color coded leads. Primary: red, red-black and blue. Following secondary leads connected to voice coil will match these impedances: black, red-yellow 1,000 ohms; black-yellow, red-yellow 1,800 ohms; yellow, red-yellow 3,000 ohms; red-black, red-yellow 6,000 ohms; black, red-black 7,000 ohms; black, green 12,000 ohms; black, yellow 22,000 ohms; yellow, red-black 24,000 ohms. Size: 3"x2½"x2¾". 4 mounting studs on 2½"x2½" centers. **5B5658—Your Cost..... 98¢**

Output Transformer And Filter Choke

(K) Two units, each with separate cores, potted and hermetically sealed in one steel case. No hum transfer. Single-ended output to line or to high or low impedance headsets. Ideal for communications receivers. Primary impedance 4300 ohms, secondary 4000 ohms with tap at 300 ohms. Reactor section is 6H at 65 ma, dc resistance 300 ohms. Terminals marked. Diagram on top. 4" H, 1½" W, 3" deep overall. Mtg. Ctrs. 1½"x1½". Shpg. wt. 3 lbs. **5B5670—Your Cost..... 1.49**

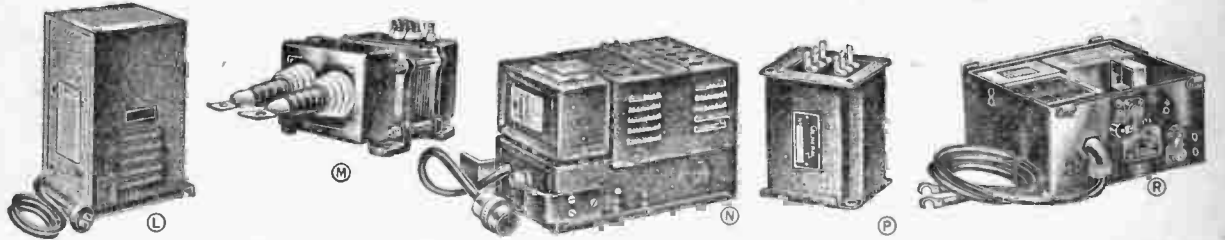

Battery Charger RA-63-D

(L) Heavy duty ruggedly constructed battery charger that delivers 12-14 volts at 10-13 amps for rapid charge. Trickle charge switch for 15 volts at 1-4 amps depending on battery condition. Heavy duty full wave selenium rectifier that will charge two 6 volt batteries connected in series, and one or more 12 volt batteries connected in parallel. Supplied with four foot, four color coded conductor cable terminated in Hubbell No. 7411 polarized plug. Operates from 115 V 60 cycle AC source. Ideal for garages, filling stations, labs, aircraft shops, and wherever 12 VDC power supplies are required. Size: 13¾"x10"x17½". Shpg. wt. 60 lbs. **5B9544—Your Cost..... 29.50**

High Current Transformer 5.1 Volts at 190 Amps.

(M) Primary—105, 110, 115, 120, 125 volts, 60 cycles at .970 K. V. A. Secondary—5.1 volts at 190 amps. Suitable for ageing filaments, small welding machines, and numerous other uses in the laboratory or shop. Primary terminals come out to 1" stand off insulators. Secondary terminals come out at heavy duty stand off porcelain insulators. Mounted in cast iron end bells and finished in baked black enamel. Overall size: 20"x10"x8". Mounting centers: 8½"x7¼". Shpg. wt., 70 lbs. **5B5124—Your Cost..... 16.95**

Inverter

(N) Input 12 volts DC, output 115 volts, 60 cy. AC at 150 watts. Ample power for mobile use of AC sound systems or other devices requiring 60-cycle input. Numerous uses on farms, boats, in summer homes, etc. Vibrator type, very efficient, low battery drain. Precision built to exacting specifications. Completely filtered for use with radio equipment. **5B9567—Your Cost..... 16.95**

Battery Charger PE-219

(R) Manufactured to rigid and exacting standards demanded by Signal Corps Specifications. Will charge 6 volt 25 ampere hour battery at a rate of 4 amps minimum from a power source of 6, 12 or 24 volts DC. Efficiency overall better than 65%. Housed in bonderized steel case finished in olive drab. Size: 10¾"x12"x6¼". Shipping weight 40 lbs. Parts value alone, with such a wealth of vibrators, connectors, and switching arrangements make this worth far more than the price asked! **5B9545—Your Cost..... 1.95**

Vibrator Transformer

(P) Primary 24 V CT. Secondary 300 V CT, 60 ma. Hermetically sealed in metal case, black crackle finish. Has eight ½" mounting holes for upright or inverted mounting. 3¾"x3"x2½" overall. **5B5097—Your Cost... 59¢**

Replacement Dual Vibrator for above. **5B9546—Your Cost... 45¢**

PANEL METERS and ACCESSORIES

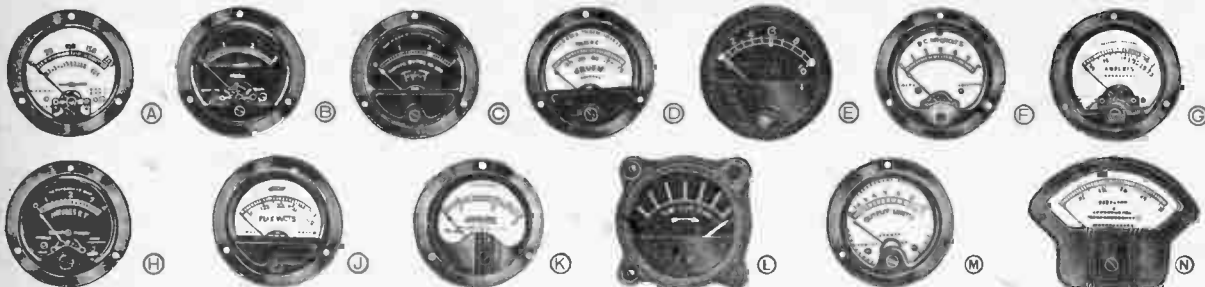

VOLTMETERS

(A) 35 volts DC full scale deflection. $2\frac{1}{2}$ " round flange. White scale, black lettering with red index mark at 28.5 volts. Simpson model K25.
5B4205—Your Cost **\$1.95**

(B) Voltmeter D.C. (Simpson Model No. 126). 8 ma. Full scale deflection. Plus or minus 2%. Scale reading 0 to 3. $2\frac{1}{2}$ " dia. x 1" d. Round face. Black scale, white lettering.
5B4207—Your Cost **\$1.95**

(C) Voltmeter D.C. (Triplett Model No. 0221T). Same characteristics as above. Round face. Black scale, white lettering.
5B4206—Your Cost **\$1.95**

(D) Voltmeter D.C. (Gruen GW Model No. 506). 0-150 scale. $2\frac{1}{2}$ " dia. x 1" d. White scale, black lettering.
5B4208—Your Cost **\$1.95**

(E) Voltmeter A.C. 0 to 1.5 V. Scale marked 0-2-4-6-8-10. Half wave rectifier. Radium dial. 1000 ohms D.C. resistance on meter side of rectifier. Dia. $2\frac{1}{2}$ " x $1\frac{1}{2}$ " d. Round face. Black scale, white lettering.
5B4209—Your Cost **\$1.95**

(F) 0-6 Kilovolt D.C. 1 ma. full scale deflection. Roller-Smith type DT. White scale, black lettering. $3\frac{1}{2}$ " round flange. Requires two of the multiplier resistors listed below.
5B4202—Your Cost **\$3.50**

Multiplier Resistor. 12 Megohms. 10 kilovolts maximum. Measures $5\frac{1}{2}$ " long by $1\frac{1}{4}$ " dia. Hermetically sealed in glass tubing with metal-to-glass bonded ferrule ends. Two required for meter above.
5B133—Your Cost Each **98¢**

(F) Weston 507. Scale 0-100 Meter 0-12 DC MA. White scale, black lettering. High quality workmanship throughout. Black metal case Flange drilled for panel mounting.
5B4215—Your Cost **\$2.25**

RF AMMETERS

(C) Amperes Radio Frequency. (Simpson Electric Model No. 135). Scale 0-3 amperes. Frequency effect less than 2% up to 10 megacycles. Dia. $2\frac{1}{2}$ " x $1\frac{1}{2}$ " d. Round face. Built-in thermocouple. White scale, black lettering.
5B4210—Your Cost **\$2.45**

(H) 0-4 amp. RF meter. Built-in thermocouple. G.E. type DN-56. Black scale, white lettering. $2\frac{1}{2}$ " round flange.
5B4203—Your Cost **\$2.45**

(D) Amperes Radio Frequency. (Hickok Electric Model No. 5661). 0-3 amperes. Frequency effect less than 2% up to 65 megacycles. Round face. Built-in thermocouple. White face, black lettering. $2\frac{3}{4}$ " flange.
5B4211—Your Cost **\$2.45**

(K) Westinghouse 0-3 ampere scale. Frequency effect less than 2% up to 10 megacycles. $2\frac{1}{2}$ " dia. round face. Thermocouple type. Less thermocouple. White scale, black lettering.
5B4216—Your Cost **\$1.95**

MILLIAMMETER

(J) 1000 DC MA full scale deflection. Black lettering. White scale. $3\frac{1}{2}$ " flange drilled for panel mounting.
5B4204—Your Cost **\$1.95**

(D) 0-20 M.A. Precision built DC milliammeter. $2\frac{1}{2}$ " flange mounting type. Black dull finish bakelite case. Mtg. Hdwe. included. Large, clearly legible dial calibrations. 0-20 M.A. DC.
5B4122—Your Cost **\$2.59**

(D) 0-300 DC Milliammeter but in dull black metal case. Requires $2\frac{1}{2}$ " dia. hole for flush panel mounting. Large clearly legible scale divisions. Depth behind panel, $1\frac{1}{2}$ ". Mounting hardware incl.
5B4118—Your Cost **\$2.69**

MILLIAMMETER

(D) 0-200 MA. $2\frac{1}{2}$ " flange mounting type. Calibrated for use on $\frac{1}{2}$ " steel panel. High quality workmanship throughout. Metal case dull black finish. Mounting hardware included.
C10650—Your Cost **\$2.69**

G.E. DECIBEL METER

(A) G.E. rectifier type AC meter. Full scale deflection: 3 V AC. Scale calibrated from -10 to +6 Db., based upon 6 milliwatts and 600 ohms. $2\frac{1}{2}$ " flange mounting type in black, dull finish bakelite case. An excellent audio meter, suitable for laboratories, schools, sound men, and experimenters.
5B4120—Your Cost **\$3.75**

WATT METER

(J) 0-1000 Peak Watts Meter 200 Micro amperes DC full scale deflection. Gruen model 250. White scale with black lettering. $2\frac{3}{4}$ " round flange.
5B4200—Your Cost **\$2.69**

TUNING METER

(L) Tuning Meter. (General Electric Model No. DW53). Has 7 divisions on scale. Marked "Tuned for Max." No numerals. Radium pointer. Has built-in pilot light of the "grain of wheat type," 3 V. Mazda No. 323. Dia. $2\frac{1}{2}$ " x $1\frac{1}{2}$ " d. Round face. Aircraft type instrument mounting. Black scale, white lettering.
5B4212—Your Cost **\$1.69**

OUTPUT METER

(M) Output Units Meter. (Weston Model No. 507). Built-in thermocouple type. Scale 0 to 10, 0 to 120 ma. R.F. Full scale deflection. $2\frac{3}{16}$ " dia. x $1\frac{1}{16}$ " d. Round face. White scale, black lettering.
5B4213—Your Cost **\$1.95**

MODULATION METER

(N) Modulation Indicator (G.E. D049). Scale, 0 to 75. 7.5 volts. Full scale deflection. $1\frac{3}{4}$ " dia. x $1\frac{1}{2}$ " d. White scale, black lettering.
5B4214—Your Cost **\$5.95**

QUALITY COILS at new LOW PRICES



COILS—Priced Very Low!

Antenna and R.F. coils furnished in unshielded type for t.r.f. sets and shielded type in round drawn aluminum cans $1\frac{1}{8}$ " x $2\frac{1}{4}$ " high for servicing 90% of all receivers on the market. High impedance primaries for screen grid tubes with 4 bank Litz wound secondaries. Wound for

LITZ-WOUND R.F. and Antenna Coils						
No.	Fig.	Application	Freq.	Shield	Mtg.	Each
C10012	A	Ant. Coil	550-1750kc	none	Bracket	35c
C10077	B	Ant. Coil	550-1750kc	Can	Spade lugs	39c
C10095	C	R.F. Coil	550-1750kc	none	Bracket	35c
C10085	D	R.F. Coil	550-1750kc	Can	Spade lugs	39c

Air-Core Condenser Tuned I.F. Transformers

No.	Fig.	Appln.	Freq.	Shield	Size	Mtg.	Each
C10069	E	Input	456	Can	$1\frac{1}{2}$ " x $1\frac{1}{2}$ " x 3"	Spd. lugs	39c
C10070	E	Output	455	Can	$1\frac{1}{2}$ " x $1\frac{1}{2}$ " x $2\frac{1}{2}$ "	Spd. lugs	39c

use with 365 mmf. variable tuning condenser. Brackets furnished. Diagram included with kits for building 4 or 5 tube set. I.F. Transformers in both permeability tuned type and air-core double tuned with compression mica trimmers adjusted from top of aluminum shielding can. RMA color coded leads.

R.F. and Antenna Coil Kits						
No.	Application	Freq.	Shield	Mtg.	Each	
C10073	1 Ant. and 2 R.F. Coils	550-1750kc	Can	Spade lugs	\$1.10	
C10071	1 Ant. and 1 R.F. Coil	550-1750kc	Can	Spade lugs	.75	
C10096	1 Ant. and 1 R.F. Coil	550-1750kc	none	Brackets	.67	

Permeability Tuned I.F. Transformer

No.	Fig.	Appln.	Freq.	Shield	Size	Mtg.	Each
SB5096	F	Input	456	Can	$1\frac{1}{2}$ " x $1\frac{1}{2}$ " x $3\frac{1}{2}$ "	Spd. lugs	49c



All-Purpose RELAYS

SENSITIVE RELAYS



Fully adjustable sensitive relay with 2000 ohm coil. Ideal for plate circuit or photo-cell applications. Minimum pull-in current only 2.5 milliamperes. S.P.D.T. contacts. Mounting bracket has two mounting holes.

Size: 3 1/4" long, 2 1/4" wide, 2 1/2" high.
5B4033—**Your Cost \$1.49**



45-60 VDC sensitive relay, 10,000 ohm coil. Contacts: one set of DPST normally closed, and one set of SPST normally open, rated 15 amperes at 6 volts to 5 amperes at 110 volts. Overall dimensions: 1 3/4" x 2" x 1 1/4".
5B3981—**Your Cost \$1.29**



100-130 VDC sensitive relay, 10,000 ohm coil. Contacts: 2 SPST, one normally closed and one normally open, rated 10 amps. at 6 volts to 4 amps. at 110 volts. Size: 2 1/2" x 1 1/2" x 1 1/2".
5B3982—**Your Cost 98¢**

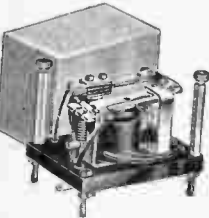

45 VDC relay, 2000 ohm coil. Contacts, one set of SPDT rated 50 amps. at 6 volts to 20 amps. at 110 volts, and one set of SPST normally open contacts rated 5 amps. at 6 volts to 2 amps. at 110 volts. This is an excellent relay for tube circuits, photo-cell alarm systems, and a host of other applications. Size: 3 1/4" x 2 1/4" x 3 3/4". With metal dust cover, external lugs, mounting screws, and wiring diagram.
5B3983—**Your Cost \$1.39**

SPDT RELAY

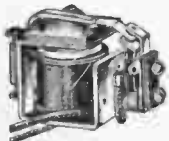

SPDT contacts of 3/8" diameter fine silver, rated at 550 watts non-inductive load at 60 cycles. Coil operates on 19 to 29 volts 50-60 cycle AC, with DC resistance of 50 ohms, 1500 volt insulation throughout. Overall size, 2 1/4" x 1 1/2" x 1 1/2".
C5950—**Your Cost 89¢**

DPST RELAYS

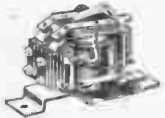

DPST contacts, normally open, of 3/8" fine silver diameter, rated at 550 watts non-inductive load at 60 cycles. Coil operates 50-60 cycle AC, requires from .6 to 1 volt with pull-in current of 4 amps. DC resistance, 1.5 ohms. 1500 volt AC insulation throughout. Overall size, 2 1/4" x 1 1/2" x 1", with mtg. bracket.
C5948—**Your Cost 89¢**

DOUBLE POLE RELAY

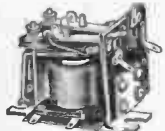

Double pole relay, with one set of SPST contacts normally open, and one set of contacts normally closed, contacts of 3/8" fine silver, rated at 550 watts non-inductive load at 60 cycles. Coil operates on 14 to 32 volts, with DC resistance of 27.5 ohms. Overall size, 2" x 2 1/4" x 1 1/2", with mtg. bracket.
C5941—**Your Cost 39¢**

110 VOLT AC RELAYS FOUR-POLE RELAY



A heavy duty relay with two sets of SPDT contacts, and two sets of SPST contacts, normally closed. All metal parts are bright-plated and all soldered joints are carefully enameled to prevent corrosion. Contact arms and springs are heat-treated beryllium copper, and contacts are 1/2" pure silver, slightly crowned. Each set of contacts is rated at 6 amperes at 115 volts AC. Relay coil consumes 6 VA at 115 volts AC. Normal pull-in voltage, 92 volts; drop out voltage 75 volts. Base and insulation are natural brown canvas bakelite. Base size 3 1/2" square, 1/4" thick. Overall height 1 1/2". Shpg. wt. 1 lb.
C14251—Leach No. 2129BF...**\$1.89**



SPST contacts, normally open, of 3/8" diameter fine silver, rated at 550 watts non-inductive load at 60 cycles. Coil operates on 95 to 125 volts 50-60 cycle AC, with DC resistance of 550 ohms. Overall size, 2 1/2" x 1 1/2" x 1 1/2".
C5945—**Your Cost 69¢**



**AC RELAY
COIL OPERATES
ON 110VAC.**

Finest material and workmanship. Two separate coils connected in series and mounted on a single 3x3 1/2" phenolic block. 2" high. Each armature carries a bakelite block on which are mounted a SPDT and a SPST normally open set of contacts rated at 15 amps., 110 VAC. All sets of contacts are insulated from each other and the frame by bakelite insulation. Screw terminals. Coils may be connected in parallel to work at a lower voltage.
5B4100—**Your Cost \$2.45**

THERMAL TIME DELAY RELAY



Leach type 1054T with 375 ohm 24 volt D.C. coil. Delay adjustable from 20 seconds to 1 minute. 3/4" fine silver D. P.S.T. contacts, normally open. Will handle 50amps. at 12 volts D.C. 25 amps at 24 volts D.C. 6 amps at 110 volts A.C. Metal base with 8 mounting holes. Size 3 1/4" long, 2 1/2" wide, 1 3/8" high.
5B4030—**Your Cost \$1.19**

THERMAL TIME DELAY REPLACEMENT UNIT



Mounted on glazed porcelain base with 6" flexible copper braid connecting leads. Adjustable from 20 sec. to 1 minute. Exact replacement for 5B1030, listed above.
5B3989—**Your Cost 29¢**

AC SOLENOID



Compact solenoid, DC Resistance 20 ohms, wound on brass tube with I.D. of 210". Operates on 6 to 10 volts AC, constant duty, or 4 to 7.5 volts DC constant duty. Overall dimensions 1 1/2" long, 3/8" diameter.
C10282—**Your Cost 19¢**

D.P.D.T., 24 VOLT RELAY



1/4" pure silver contacts rated at 6 amps. 110 volts a.c. Bakelite insulation. Coil resistance 230 ohms d.c. 6-32 threaded mounting holes on 1 1/4" by 1 1/4" centers. Overall size: 2" by 1 1/4".
5B3990—**Your Cost 69¢**

4 P. D. T. 24 VOLT RELAY



1/2" pure silver contacts rated at 3 amps. 110 volts a.c. 250 ohms d.c. coil for 24 volt operation. 6-32 threaded mounting holes on 1 1/4" mounting centers. Overall size: 2" by 1 1/4".
5B3996—**Your Cost 49¢**



STARTING RELAY

12-14 VDC heavy duty starting relay with 13 ohm coil. SPST contacts normally open. Excellent for starting dynamometers and heavy motors. Overall dimensions approx. 3 1/4" x 2 3/4" x 2 3/8". Similar to General Electric Contractor No. CR2800-384B2.
5B4301—**Your Cost 89¢**
6 VDC relay, with coil resistance of 16 ohms. Contacts SPST—double break—normally open—rated 30 amp. at 6 volts to 10 amps at 110 volts. Measures 2 3/8" x 1 1/2".
5B4300—**Your Cost 59¢**

SELENIUM RECTIFIER

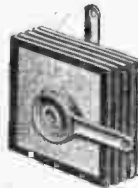

★ No Warm Up Period
★ Easily Installed
★ Costs Less

Saves space—only 1 1/4" x 1 1/4" x 1 1/4"—fits where tube won't. Costs less than tube and socket it eliminates.

Long life—built to last the life of set. No warm-up period. Starts instantly and runs cooler because no filament current is required. Installed in less time than tube—only two soldering jobs. Two rectifiers may be connected as a voltage doubler to supply 250 volts at 80 ma. from 117 volt AC power supply. Sturdy all-metal construction not easily damaged. Withstands overloads even when charging deformed electrolytic condensers.
C10560—**Your Cost 75¢**



CRYSTAL PICK-UP

High quality crystal pick-up mounted in arm for 10" and 12" records. Mounting included. Requires 1/2" hole. Shielded lead and cartridge case. Aluminum die-cast arm finished in smooth dark brown. Less needle.
5B3551—**Your Cost \$1.59**

RESISTORLESS NEON BULBS

For use in Test instruments noise silencers, and RF protection on receivers Type NE-2 with a wattage rating of 1.25th watt. No base, wire terminals.
X169—**Your Cost 5¢**
10 for..... 45¢

INQUIRIES WELCOMED ON ITEMS NOT CATALOGED



SPECIAL VALUES *Quantities Limited*

Carbon Throat Microphone



This microphone will work into any 200 ohm impedance input circuit. Has adjustable strap to fit any neck. In operation this microphone is strapped around the throat thereby facilitating full freedom of both hands and head movement. Ideal for ultra high frequency mobile work for hams. Supplied with strap, 10' cord and plug.

5B7060—Your Cost..... **29¢**

Light Weight Hand Held T-17B Microphone



High quality and light weight! Sturdily constructed 200 ohm single button carbon mike with built-in hiss filter and press-to-talk switch. Complete with 5-foot rubber cord, PL-68 plug and microphone dust cover.

5B7062—Your Cost..... **94¢**

Telephone Handset



High quality unit containing a magnetic phone of approx. 1000 ohms impedance and a single button carbon microphone rated at 200 ohms. Has convenient built-in push to talk butterfly switch. Six foot heavy duty rubber covered cable provided with PL 55 plug on one conductor and PL 68 plug on the other. Overall size, 9". Extensively used in field telephone work and has numerous other applications.

5B7061—Your Cost..... **\$2.39**

8000 Ohm Headset



With plug-type ear phones and ear pads. For use with very low signals or reception where there is noise. Rubber-covered steel headband with one-foot long rubber-covered cord and jack plug PL-54.

5B7073—Your Cost..... **\$1.95**

Hearing-Aid Type Headset



Low impedance. With two 3' long rubber covered leads.

5B7074—Your Cost..... **\$1.25**

Dynamic Type Earphone and Microphone Assembly

- ★ For Intercom Units
- ★ Code Practice Sets
- ★ P. A. Systems
- ★ Home Recordings
- ★ Mobile Equipment

This unit consists of a microphone handset including a dynamic mike (50 ohm voice coil) activated by a DPST "push-to-talk" switch conveniently mounted on the handset for thumb control. The mouth piece is of flexible rubber, and the unit is completely waterproofed with oil impregnated cloth inside the mike grill. The headset is of high quality spring steel, fully adjustable, and covered with genuine leather. The earphones, (2), built on the principle of a P.M. dynamic speaker, have a moving voice coil wound to 50 ohms impedance, and are attached to mica diaphragms. The magnetic field is set up by a very high quality super-alloy electro magnet. The ear phones are 1 1/2" speakers solidly encased in black bakelite and equipped with sponge rubber cushions 3 1/8" diameter.

The mike can be removed from the headset and used for P.A. work, home recording, etc. When used separately, the phones may be used as small power speakers in intercom equipment using standard circuits. They may also be used as audible reproducers in midset code practice oscillator sets. The DPST "push-to-talk" switch has separate leads brought out and can be used in battery-saving control circuits for mobile equipment. The equipment is offered you at a small fraction of cost!

5B7055—Equipment less, extension cord..... **\$2.79**

37" extension with receptacle to fit the plug on the headset and mike, facilitates disconnecting the entire unit at will.

5B7056—Your Cost..... **19¢**



Chromium Plated Steel Case



A beautifully built, highly polished chromium plated steel case, ideal for test equipment, oscilloscopes, amplifiers, etc. Has removable bottom, ventilating louvers on all sides, particularly sturdy for use with heavy equipment. Measures 9 3/4" high, 7 1/2" wide, and 12 1/4" deep, with 2 1/2" diameter hole in front panel, and 1 3/8" hole in top panel.

C22276—Your Cost..... **\$1.95**

Antenna Reel

Sturdy, rustproof heavily galvanized wire frame reel with freely turning handle and crank. Ideal for winding and storing antenna wire, cables, clothes line, rope, twine, etc. Winding area 8 1/4" x 3" inside and 11 3/4" x 4 1/4" outside. Handle 3/8" dia. x 4 1/2" long, crank handle 1/2" dia. x 1" long.

5B6549—Your Cost..... **29¢**



Break-In Telegraph Key



Mounted on bakelite base 4 3/4" x 3". Jumper strip with binding posts also mounted on base with key. Has binding post connections and circuit closing switch. 1/8" solid silver keying contacts. All metal parts cadmium plated. This is an excellent key for sounder and buzzer telegraph systems, as it is equipped with 2 sets of binding posts, one set mounted on a jumper strip and the other set mounted on the key.

5B6543—Your Cost..... **39¢**

Circuit Breaker



Completely housed in molded plastic case with reset switch on front. Fast positive action. Enclosed case completely flame proof. Mounts with

two 10-24x1/2" mounting studs which are also the terminals. Can be used to replace fuses as service can be restored after short circuit or overload is corrected by merely throwing the toggle switch to "ON" position. Size: 3"x3"x1". Two types as listed below, all are for use on 115V AC or DC.

5B4058— **\$1.39**
220 MA.....
5B4059—9 Amp..... **1.65**

Battery Cord Set



Consists of 7 1/2 feet of 2-conductor flexible twisted pair cable, each conductor No. 14 stranded tinned heavily insulated copper wire, color coded yellow and black; 2 heavy duty 4" battery clips on one end and one 4 female contact plug on the other end and fuseholder with 5 amp. fuse in yellow (positive) lead near plug end. For use wherever storage batteries are used.

5B6537—Your Cost..... **29¢**

Neutralizing Tool Kit 12 Tools Telescope Into 5 Units



This kit is composed of alligator side wrench, 6" insulated driver—metal nib, 5/16" and 3/8" nut wrench, 3/4" insulated square nut wrench, 1/2" hex metal side wrench, 2 1/2" insulated driver with metal nib, 3/4" hex slotted insulated wrench driver, 3/8" hex insulated nut wrench, 5" and 6" insulated driver

5B6547—Your Cost..... **\$2.37**

Live Rubber Mounts



Excellent live rubber mounts for floating gang condensers, sockets, and record changers to prevent microphonics. Size 3/8" x 3/8".

C14798—Per Doz..... **10¢**
Per 100..... **.60¢**

Experimenters Motor

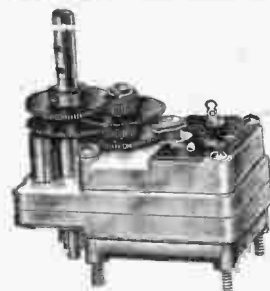

Compact induction type AC motor operates from 25 to 30 volts AC, 60 cycles. Motor speed 2400 RPM, with gear train driving 1/4" shaft at 24 RPM. Has clutch which disengages motor from gear train when power is removed, and friction brake on gear train which prevents shaft from continuing rotation when power is removed and clutch drops out. For intermittent operation, with thermal cut out which prevents overloads from injuring motor. Measures 2x1 1/2"x3" overall, excluding shaft, which is 1/2" o.d. extending 2 1/2". For operation in any position but clutch is operative only when the shaft is in a horizontal plane. Mounts by means of four 1/8" Studs extending 3/8" from case.

C14699—Your Cost..... **\$2.50**



SPECIAL VALUES *Quantities Limited*



7 Tube Chassis

(A) Punched 7-tube chassis, tern plated, measuring 14" long, 7" wide, 2 1/4" high, excellent for radio and amplifier builders.

5B9564—**Your Cost** **29¢**

1S4 Tube Shields

(B) Miniature tube shield for tubes such as 1S4, etc. Aluminum with retainer spring inside. 1 3/4" high x 3/4" diameter.

5B7020—**Your Cost Each** **4¢**
10 for **30¢**



Jack Box

(C) Consists of one 3-circuit jack, one single-circuit jack, one 150,000-ohm potentiometer, and 5-position rotary switch enclosed in an aluminum case 4 1/2" long, 3" wide, 3" high. Shipped complete with knobs. Circuit diagram inside cover. Shpg. wt., 2 lbs.

5B3959—**Your Cost** **25¢**



Tool Roll

(A) Simulated leather tool roll. Has a strap with 15 slots to carry several pliers, screwdrivers, socket wrenches, etc. When tools are packed in this roll, they make a neat and compact tool kit.

5B9521—**Your Cost** **19¢**

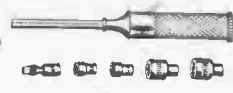

Ceramic Octal Socket

(D) A low-loss, heavy-duty socket on 1 1/2" mounting centers. Firm gripping cylindrical pin contacts silver plated. Sturdily constructed. Heavy ceramic body seated in pressed steel shell. Soldering tabs and four mounting lugs pre-tinned, provided with 3/8" holes.

C13109—**Your Cost Each** **9¢**
10 for **81¢**



Bakelite Knobs

Molded and polished walnut bakelite knobs for 1/4" shafts. "A" is spring-clip, push-on type; diameter is 1 1/8". "B" is for knurled shafts; diameter is 1". Fine for Experimenters, Amateurs or Builders.

Stock	No.	Type	Each	For	For
	C9625	A	5c	40c	\$3.00
	5B249	B	5c	40c	3.00

Knob Kit

Kit of 20 assorted knobs. A real addition to your knob stock box at a real bargain price!

5B6984—**Your Cost Per Kit** **59¢**



Fuse Holder Kit

(C) Consists of one Littelfuse No. 1068 double fuse mounting, three 5-amp. 3AG fuses, two 3/16 x 3/4" screws, two No. 6 lock-washers, two 1/2 x 3/4" brass rivets, two Littelfuse clips No. 1011, and two 3/16" steel nuts.

5B145—**Your Cost** **10¢**

Extractor Fuse Posts

(D) Black bakelite fuse holder for type 3AG fuse. For panel mounting with 1 1/4" bushing equipped with insulating rubber washer, lock washer, and nut. Extends 1 1/8" behind panel and has rugged solder lugs.

5B238—**Your Cost** **16¢**

Five-in-One Tool Set

(B) Cadmium-plated steel shank and knurled handle, hollow to store five snap-on tips. End of handle unscrews to remove tools. Tips are: 3/8 x 3/16" screwdriver and 3/16", 3/8", 7/16", and 1/2" socket wrenches. 7 1/4" long. Wt., 2 lbs.

5B9885—**Your Cost** **79¢**

Ceramic Socket For 832, 829

(C) An excellent purchase makes this highest quality transmitting-tube socket available at less than manufacturer's cost. 1/4" thick white ceramic, glazed on top side, 2 3/8" square with rounded corners, reinforced 3/16" mounting holes on 1 1/2" x 1 1/2" centers. Seven silver plated powerful spring-grip contacts with two soldering holes each, firmly riveted in place and reinforced by cast cutout in the ceramic.

5B6986—**Your Cost** **29¢**

Low-Loss Octal Socket

(E) Flush mounting high quality low loss phenolic compound socket seated in heavy rust-resisting steel saddle. Provided with four grounding lugs. Tubular gripping silver-plated contacts end in two hole terminals.

5B6979—**Your Cost, Each** **5¢**
10 for **43¢**

Pilot Light Socket

(F) A two-contact bayonet type of socket requiring 3/4" dia. hole for mounting flange. Retaining ring included. Two solder lug terminals.

5B247—**Your Cost** **15¢**
10 for **\$1.35**

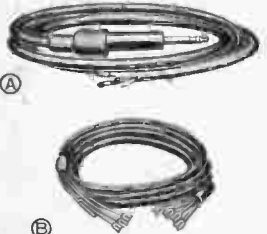

Microphone Cord & Plug

(A) 3-circuit mike plug PL-68 connected to rubber covered 3-conductor cord 4 ft. long. Strain-relief rubber over end of plug. End of cord terminates in two connecting lugs, tinned ground lead, and tie-cord fastened to eye-hole lug. Flexible and durable. Excellent for Push-to-talk Mike Applications.

5B5145—**Your Cost** **19¢**

Three-Conductor Cable

(B) 10-foot 3-conductor rubber-covered cable with colored leads and No. 10 spade lugs and tie cord at each end. Heavy-duty tinsel wire, live rubber insulation. Excellent for phone, mike, speaker applications requiring flexibility of cable under rough, tough conditions.

5B5138—**Your Cost** **22¢**

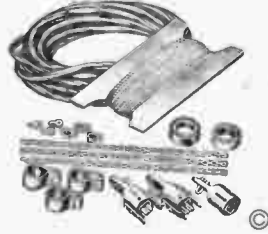

Interphone Cable Kit

(C) Consists of: 125' 3-conductor cable, 75' No. 72 Seine Twine, 1 roll 6' red acetate tape, 1 roll 6' white acetate tape, 2 cable clamps, 1 4-prong Jones plug in aluminum jacket, 1 4-prong Jones socket in aluminum jacket, and 2 pull chain assemblies. Useful in P.A. or intercommunication system installation.

5B6991—**Your Cost** **98¢**

Similar to 5B6991 but with slightly different quantities. Consists of: 35' 3-conductor cable, 2 lb. No. 72 Seine Twine, 1 roll 6' red acetate tape, 1 roll 6' white acetate tape, 3 cable clamps, 1 4-prong Jones socket assembly in aluminum jacket, 2 4-prong Jones plug assemblies in aluminum jackets, and 3 pull-chain assemblies.

5B6992—**Your Cost** **59¢**



30 MH RF Choke

(A) Wound on ceramic form, with lug terminals. Mounts by means of screw through center hole or two mtg. holes in base. DC resistance is 136 ohms. Maximum DC is 125 ma.

C10134—**Your Cost** **39¢**

APC Air Padder Condensers

(B) Ceramic insulated air padder condensers ideal for circuits requiring a constant capacity under all climatic conditions such as oscillator circuits, IF transformers, fixed tuned circuits, etc. Sizes under 100 mmf have screw-driver slot adjustment. The 100 mmf size has 1/4" shaft 7/8" long. A record low price for this high quality item.

Stock No.	Mmf	Each
5B3511	25	16¢
5B3206	35	16¢
5B3512	50	16¢
5B3518	100	19¢

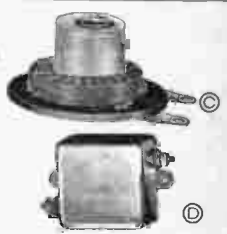

Unshielded R.F. Chokes

(C) All-purpose unshielded r.f. chokes. Universal-wound, accurately rated and factory tested. Thoroughly impregnated—will give long, trouble-free service.

C10133—2.5 Millihenries. **Your Cost** **18¢**

C10135—60 Millihenries. **Your Cost** **29¢**

Radio Noise Filter

(D) Keeps hash out of power lines when connected at source of noise, or removes hash from radio when connected to incoming line. In hermetically sealed case 2x2x1 1/4" high, with two mounting lugs on 2 3/4" centers. Case is grounded, hot leg of 115 V AC line goes to terminal at other end. Rated at 10 amps. Shpg. wt., 2 lbs.

5B3239—**Your Cost** **59¢**

IMMEDIATE SHIPMENT FROM CHICAGO OR ATLANTA

Hard to find **VARIABLES** FOR EVERY PURPOSE

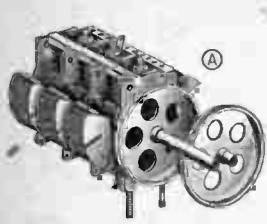

2 Gang Condenser with Band Spread

(A) Section one 39.7 mmfd. min. to 353.4 mmfd. max., section two 33.9 mmfd. to 353.3 mmfd. max., band spread both sections 20 mmfd. Sturdily constructed, useful for portable or small superheterodyne receiver. Single spaced aluminum plates with low loss bakelite insulation. Both shafts mounted on ball bearings and with ball thrust adjustment. 2" dial pulley mounted on each shaft. Size: 4x2 1/4 x 2 3/4". **5B3562—Your Cost..... 69¢**

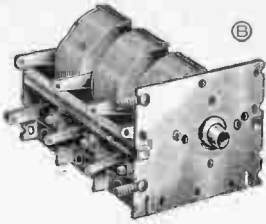

3 Gang with Band Spread

(A) 12.5 mmfd. min. to 410 mmfd. max each section, band spread 20 mmfd. Sturdily constructed. Replacement for use in nationally known communications superheterodyne receivers. Single spaced aluminum plates with low loss bakelite insulation. Main tuning shaft extends 2 3/4" from front of condenser, band-spread shaft extends 1 3/4" from front of condenser, both shafts have 2" dial cable pulley attached. Size: 6 1/4 x 3 1/2 x 3 1/2". **5B3561—Your Cost..... \$1.19**

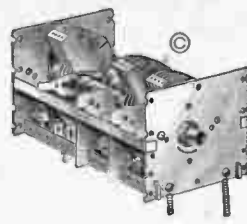

U.H.F. 3 Gang

(C) 6 mmfd. to 54.7 mmfd. maximum each section. These sturdily constructed condensers are ideal for use in UHF. Double spaced aluminum plate, ball bearing rotor shaft with ball thrust end adjustment, and micalex insulation. Front rotor is grounded to frame, center and rear rotors have provisions for insulating from frame and each other. Shaft 3/8" dia., 3/8" long. Size: 6 3/4 x 3 1/4 x 2 3/4". **5B3567—Your Cost..... 98¢**

3 Gang with Band Spread

(A) 352 mmfd. max. each section, band spread 20 mmfd. max. Sturdily constructed, for use in communications superheterodyne receivers. Single spaced aluminum plates with low loss bakelite insulation. Brass shafts mounted on ball bearings with ball thrust adjustment. 2" dial cable pulley mounted on each shaft. Size: 4 3/8 x 3 1/2 x 2 3/4" overall. **5B3563—Your Cost..... 79¢**

3 Gang Condenser

(B) 12.5 mmfd. min. to 562.8 mmfd. max. each section. Sturdily constructed condenser, used in superheterodyne receivers for standard broadcast and short wave. Single spaced aluminum plates with brass rotor shaft. Shaft is mounted in ball bearings with ball thrust adjustment. Stator plates are mounted on low loss bakelite insulators. Size: 5 x 3 1/4 x 2 3/4". Shaft 3/8" dia. x 3/8". **5B3564—Your Cost..... 89¢**

Broadcast Tuning Condensers

(D) Two sections. RF section 420 mmfd., Osc. section 162 mmfd. Trimmers each section 20 mmfd. Ball bearings with ball end-thrust adjustment. Condenser body 1 1/2" wide, 1 1/2" high, 2 3/4" deep. Shaft extends 3/4". Cable drum permanently installed at factory. Ideal for making small receivers and portable equipment. Shpg. wt. 1 lb. **5B3569—With 3" drum..... 98¢**
5B3570—With 4" drum..... 98¢
Your Cost Each..... 98¢

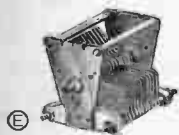

JOHNSON Variable Condenser

(E) Rugged, compact unit for medium and low-power transmitters. .032" thick aluminum plates. Steatite insulation. Heavy phosphor-bronze contact springs. Capacity 12 to 244 mmfd. .045" spacing. Approximate breakdown is 2000 volts. Slotted shaft 1/4" dia., 3/4" long. **5B3572—Your Cost..... \$1.29**

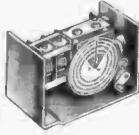

3 Gang Calibrated Condenser

(F) Two 250 mmfd sections and one 260 mmfd. 4" dia. calibrated dial, Vernier gear drive 1/4 x 3/4" shaft. Ceramic insulation. **5B3559—Your Cost..... \$1.95**

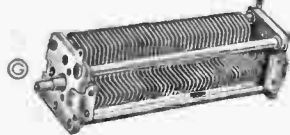

Single-Section Condenser

(G) Steatite insulation, 500 mmfd. 2x1 7/8 x 6 3/4". **5B3571—Your Cost..... 98¢**



ICA 140 Mmf. Midget Condenser

(H) For communications receivers and transmitters. Compact, rugged and highly efficient. Ceramic insulation, sturdy lug terminals, single hole mounting feature, etc. 1/4" shaft plated to resist corrosion. Capacity 7 to 140 mmfd, 19 plates. With mounting nut. Shpg. wt. 1 lb. **C9714—Your Cost..... \$1.03**

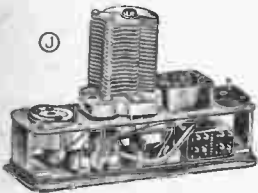

Special Assembly

(J) A compact foundation for a transmitter or receiver. Metal frame with 10-contact female receptacle at bottom, 140 mmfd. variable capacitor with screwdriver adjustment on top, miniature polystyrene coil socket, dual crystal socket, and male contact socket with spring locking clip. 4" long, 1 1/4" wide x 2 3/4" high. Tuning condenser alone is worth more than the price of the entire assembly. **5B3553—Your Cost..... 39¢**

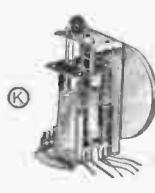

Permeability Tuner

(K) Standard Broadcast Band Ant., RF, and oscillator coils. 455 kc 1F. All simultaneously tuned by slugs screwed to moving cradle Slugs can be individually adjusted for tracking alignment. Cradle moves on rigid slides and is driven by cord and idler assembly from standard large pulley. **5B3573—Your Cost..... \$1.49**

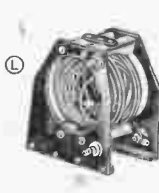

Variometer

(L) Smoothly operating perfectly balanced variable inductance with range of 2.5 to 7 microhenrys. Coils are double spaced silver plated solid heavy copper wire mounted on ceramic insulation. Frame is low loss laminated linen base phenolic with ceramic feed through terminals and ceramic shaft coupling. Size: 5 x 4 1/2 x 3 3/8". 4 mounting holes tapped No. 6-32 on 3 1/2 x 2 3/4" centers **5B7068—Your Cost..... 49¢**



Neutralizing Condenser

(M) Capacity 3 mmfd. to 11 mmfd. Suitable for neutralizing low power transmitter amplifier stages. Body made of steatite for mounting in a 3/8" hole, or may be suspension mounted. Capacity is variable by plunger-like action. **5B3171—Your Cost..... 7¢**



MEISSNER Midget Alignaie

(N) Bakelite cased 1 to 12 mmfd. midget air trimmer. Bracket attached to movable element for mounting. 1/16 x 1 3/8". **C9740—Your Cost..... 9¢**

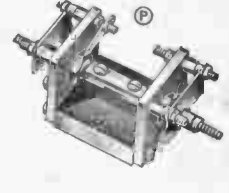

2.8 Mmf Dual Condenser

(P) Maximum capacity per section, 2.8 mmfd., minimum, .2 mmfd. Micalex coupling between sections, isolantite end plates. Each section two plates, 10" spacing, with rounded corners. Low loss bakelite base with two holes for base mtg. can be removed and each section used as separate condenser if desired. 6-32 threaded stud projects from back of each section, 1/4" shaft Overall size: 1 1/2 x 1 7/8 x 4". **5B3503—Your Cost..... 59¢**

VALUES for Servicemen ORDER NOW!

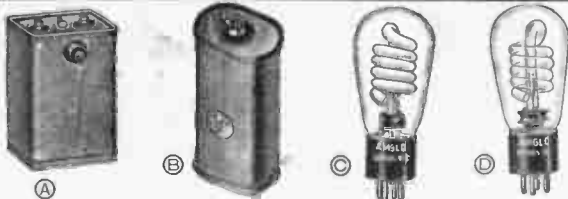

PHOTOFASH COMPONENTS Hi-Voltage Power Supply

(A) Type PS-1 power supply. Simple and safe to use, sealed-in metal case. Only three terminals to connect. Porcelain stand-off insulator for high-voltage output. Input 117 v 60 cycle AC, output will charge capacitors to 2250 v DC. Maximum load 50 mfd. Size: $4\frac{1}{2} \times 3\frac{3}{4} \times 5\frac{1}{2}$ ". Wt. 2.2 lbs. **C1989—Your Cost** **\$11.14**

(B) Small lightweight units for use with the PS-1 power supply. Peak volts 2250, energy storage 7.6 watt-seconds, 3.2 mfd. Professional results can be obtained by the use of 8 or 10 capacitors in parallel, good results with as few as 6 connected in parallel. Increasing number of capacitors used gives increased light intensity. Approximately 15 seconds required to charge 8 capacitors. Size: $4 \times 2 \times 1\frac{1}{4}$ ". Shpg. wt. 5 lbs. **C1029—Your Cost Each** **\$2.91**

AMGLO Photoflash Lamps

(C) Light intensity rated 100 times that of sunlight. Superb results with either Kodachrome or Black and White. Many thousands of flashes per bulb. Duration of flash less than one ten-thousandth second, get clean action shots. High color temperature, 6500° Kelvin with standard circuits, closely simulates daylight. Requires standard 4-prong radio tube socket.

C10582—Type 51Q4X. Energy rating 40-60 watt-seconds. For use with PS-1 power supply and up to 8 Plasticon capacitors listed above. **Your Cost** **\$13.23**

(D) **C10583**—Type 48R4X. Energy rating 60-200 watt-seconds. For use with PS-1 power supply and up to 26 Plasticon capacitors listed above. **Your Cost, Each** **\$14.70**

NOTE: See other pages of this catalog for listings of additional photoflash equipment: Transformers, condensers, relays, thyatron control tubes.



Tire Static Neutralizer Powder

(A) Consists of simple injector and bags of anti-static powder, made under patent license from U.S. Rubber Co. When injected into tire, eliminates static from car radio, eliminates the electric shocks obtained when you step out of a car and touch the door handle, eliminates spark bites in inner tubes. Powder packed in individual bags, one for each tire, including spare. Tire need not be completely deflated to inject. Simply screw injector into valve, fill with powder, and blow air into tire, through the injector, with air hose at filling station. Powder is effective during the entire life of the inner tube. **C15540**—Injector and 5 bags of powder. **Your Cost** **\$1.50**

C15581—Powder only, sufficient for 5 tires. **Your Cost** **59c**

TELETRONIC Induction Telephone Pickup

(B) Picks up telephone conversations. Simply place the phone base, either cradle or upright type, on the pick-up platform and connect the leads of the pick-up to the high-impedance microphone input terminals of any audio amplifier. When used for Public Address work, a speaker at home or in another city can address large audiences without special phone circuits; or use it to record important telephone conversations. **C22506**—Your Cost **\$29.50**

Dealers Are Invited to Write for Quantity Discounts

PLASTICON Glass Mikes

Vacuum sealed hi-voltage capacitors. Tolerance $\pm 10\%$. Type A has 8-32 screw terminals, removable solder lugs, type B has 2" pigtails. Both can be mounted in fuse clips, both are Silicone filled.

Stock No.	Mfr's No.	Type	Cap. Mfd.	Volts DC.	Dia.	Length	Your Cost
C1030	ASG15	B	.01	2000	$1\frac{1}{2}$ "	$1\frac{1}{2}$ "	\$1.32
C1031	ASG17	A	.05	2000	$\frac{3}{4}$ "	$1\frac{1}{2}$ "	1.65
C1032	ASG18	A	.1	2000	$\frac{3}{8}$ "	$2\frac{1}{2}$ "	1.88
C1033	ASG30	A	.01	5000	$\frac{3}{4}$ "	$1\frac{1}{2}$ "	4.26
C1034	ASG33	A	.1	5000	$1\frac{1}{2}$ "	$3\frac{1}{2}$ "	5.35
C1035	ASG40	B	.0005	10000	$1\frac{1}{2}$ "	$1\frac{1}{2}$ "	4.29

NOTE: Glass mikes are available in various capacities and voltages from 600 V. to 30,000 V. Write for literature and prices.

3 Section Side Cowl Antenna

Extends from $31\frac{1}{2}$ " to 96", with three sections. Special shims eliminate rattle and vibration. Two-hole universal mounting. Bakelite body insulators have grommets to insure accurate fit. Moisture-proof braided shield lead-in. Chromium plated finish.

C22037—Your Cost **\$1.89**

Vertical Antennas

Copper tubing, olive drab painted, three section vertical antennas, each section 4 feet long with threads to screw into next section. Total length approx. 12 ft. when assembled. Tapered along complete length from $\frac{3}{8}$ " dia. to $\frac{1}{4}$ ". **5B9512**—**\$1.50**

Two-Section Antenna

Goose Neck Type
Overall size 34". Made of 2 brass sections with an extended length of 24" mounted on a 7" flexible base which permits adjustment to any angle desired. Collapsed—measures only 17". Threaded mounting rod extends $\frac{1}{4}$ " below base. Connection provided for grounding. Finished in olive drab. Ideal for ultra high frequency portable transmitters and receivers.

5B9539—Your Cost **\$9.95**

Ground Rod

Made of heavy steel 16" long and $\frac{3}{4}$ " inch dia. Has pointed end for easy driving. **5B7099**—Your Cost **19c**



SOLAR Heavy Duty Line Filter

(A) Power line disturbances caused by refrigerators, oil burners, fluorescent fixtures, barber equipment and other electrical devices are filtered out or eliminated at the source. Building power lines should be protected from radio interference by connecting filter between unit and line. For example oil burner to filter and filter-to-line. If source cannot be determined, then connect between line and radio. Case should be grounded with terminal provided. Inductance-capacity type to provide heavy-duty filtering up to 20 amps at 115 VAC, 600 VDC. Five terminals, center terminal ground. Dimensions: $4\frac{1}{2}$ " long $2\frac{1}{2}$ " wide, $2\frac{1}{2}$ " high. **5B3218**—Your Cost **\$1.79**

6 Volt Vibrator

(B) Replacement for Mallory 294, 4-4, Radiart 5300, SO-1, Utah NP-42, Delco 5,040,000, 5,052,378 and Meissner EO1. **5B3950**—Your Cost **\$1.05**

"Zip" Wire Stripper

(C) Strips wire instantly! Fasten wire stripper to bench or other support. Adjustable stop enables wire to be stripped to any length. Pivoted blades will strip insulation clean in one operation. Suitable for any wire up to 12MM diam. Size: $2 \times 2 \times \frac{1}{2}$ ". **C15268**—Each **75c**

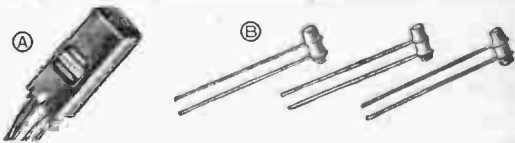

STANWYCK Midget FM Coils

(A) Complete 10.7 mc IF coils and discriminators in aluminum cans. Carefully engineered for best selectivity and maximum audio fidelity. Compression mica trimmers. Each trimmer paralleled by ceramic capacitors. Extremely stable high quality assembly. Can $\frac{3}{4}$ " sq. x $1\frac{1}{2}$ ". **C10353**—IF Coil. **Your Cost** **\$1.23**
C10354—Discriminator. **Your Cost** **\$1.41**

CENTRALAB HI-KAP Ceramic-X Capacitors

(B) Longer life, better performance. Extremely small and compact. Negligible temperature coefficient. Flash tested at 1000 volts. DC working volts 600.

Stock No.	Mfd.	Each	Stock No.	Mfd.	Each
C1000	.00005	15c	C1005	.00075	15c
C1001	.0001	15c	C1006	.001	15c
C1002	.00015	15c	C1007	.002	15c
C1003	.00025	15c	C1008	.005	18c
C1004	.0005	15c	C1009	.01	18c

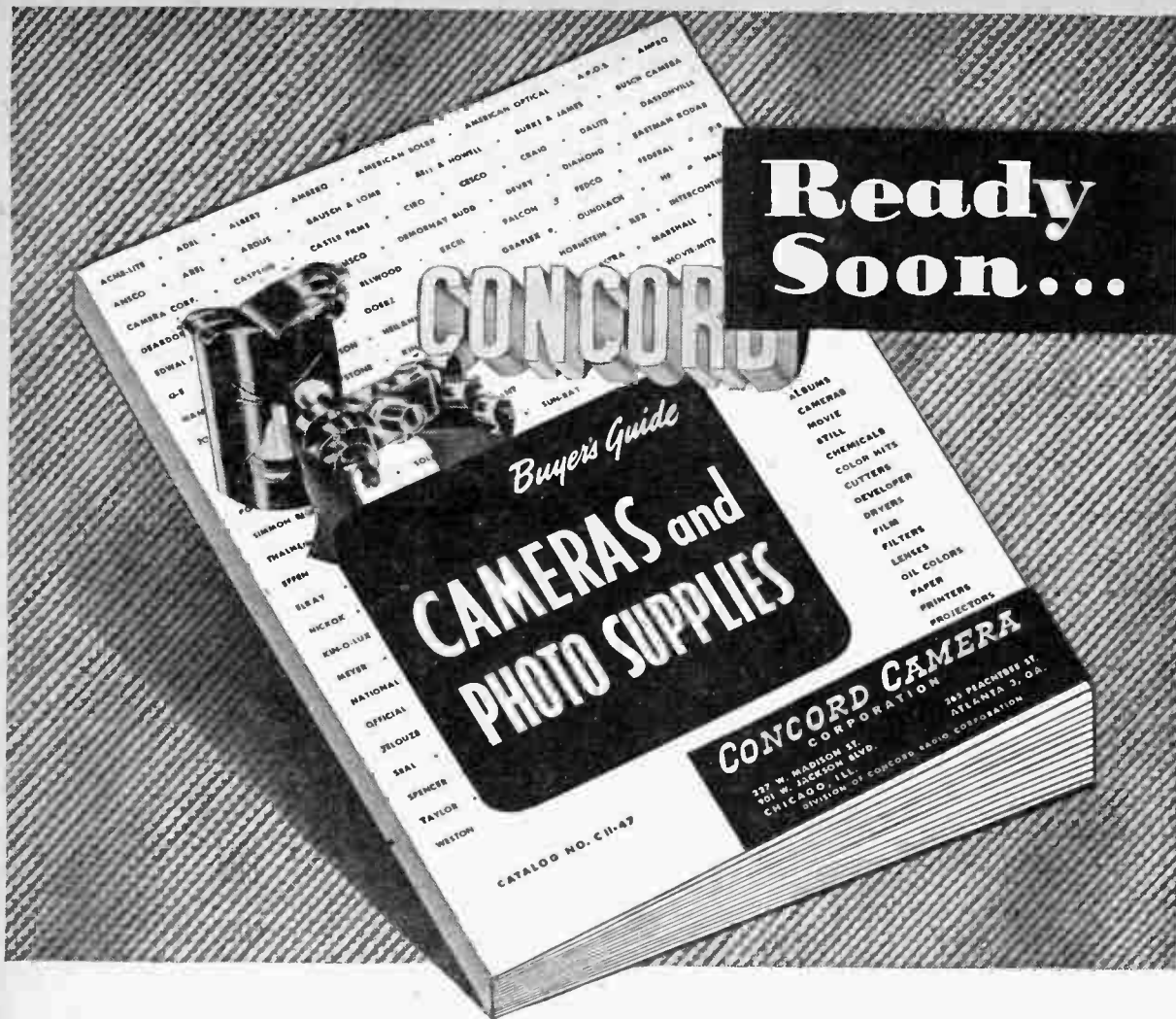

Save Money On All Your Photographic Needs!

CONCORD CAMERA CATALOG

For Everything in Photography at Money-Saving Prices

The new, post-war Concord Camera Catalog has everything. Here is a partial list of the brand-name items you'll find ready for immediate delivery . . .

American Bolex • Ampro
 Ansco • Argus
 Bausch & Lomb • Busch
 Bell & Howell • Castle Films
 Dalite • Deardorff • Dejur
 Eastman Kodak Falcon
 Federal • G-E • Gevaert
 Graflex • Heiland • Ilex
 Keystone • Natco • Perflex
 Polaroid • Revere • Solar
 Univex • Victor • Vokar
 Weston • Wollensak

It's Big!

It's Complete!

It's FREE!

Exciting news for camera fans! It's here again . . . for the first time since the war . . . the big, complete CONCORD CAMERA CATALOG that makes it easy for you to get everything in photographic equipment and supplies AT BIG SAVINGS! And it's FREE . . . yours for the asking!

Whatever your needs in photography . . . from micro-film to the most elaborate equipment . . . you'll find what you want in the big CONCORD CAMERA CATALOG now on the press and ready soon for distribution. And it doesn't cost a cent! Wait 'til you see the exciting array of cameras, enlargers, light meters, tripods, film, EVERYTHING . . . all the famous, nationally-advertised makes . . . and all at low, money-saving prices!

If you're buying . . . or planning to buy photographic equipment and supplies—hold up until you get this big camera catalog. Paper shortages limit the number of catalogs we can print at this time. So make absolutely sure you get yours fast by mailing the coupon now. We'll reserve your copy and mail it as soon as it's off the press.

**Reserve
 Your Copy**

**MAIL
 COUPON NOW!**

CONCORD CAMERA CORP.
 901 W. Jackson Blvd.
 Chicago 7, Illinois

Of course! Put my name at the head of the list to receive the FREE Concord Camera Catalog.

Name

Address

City..... State.....

Line Cord Resistors



Flexible, sturdy cords for AC-DC radios, field supplies, phono oscillators, etc. Ratings are at .3 amps. Voltage drop subtracted from your line voltage gives total voltage applied to tube filaments.

No.	Ohms	Voltage Drop
C5322	135	40.5 volts
C5332	150	45.0 volts
C5331	160	48.0 volts
C5323	180	54.0 volts
C5330	200	60.0 volts
C5324	220	66.0 volts
C5325	250	75.0 volts
C5329	280	81.0 volts
C5242	310	93.0 volts
C5326	330	99.0 volts
C5241	360	108.0 volts
C5320*	560	*78.75 volts

*This cord used in 3-way portable sets. Voltage drop calculated for .15 amp. drain.

Your Cost Each..... **69¢**

UNIVERSAL Resistor Cord



A replacement cord for all makes of receivers. One cord fits any type set. Any normally used resistance from 22 to 330 ohms in one cord. Complete instructions supplied with each cord. Ideal for servicemen and dealers.

Your Cost Each..... **88¢**

Special AC-DC Cords With Pilot Light Tap

Like above, with pilot light tap. Tinned leads.	Stock No.	Total Ohms	Tapped at Ohms	Your Cost
C5334	160	24		81¢
C5335	180	25		
C5336	200	40		
C5337	200	25		
C5339	280	40		

220 Volt to 110 Volt Line Cord Resistor



American cord equipped with standard male plug and female receptacle. European type has foreign plug and standard receptacle. Indispensable to servicemen abroad. Can be used on shavers, handblowers, small radios (up to 7 tubes), and small appliances.

C5243—Standard 300 ohm for sets using .3 amp. tubes, 50 ma. plate supply. Tot. cap. 350 ma.
C5244—Same but foreign.
C5245—Standard, 560 ohms for sets using .15 amp. tubes, 50 ma. plate supply. Tot. cap. 200 ma.
C5233—Same but foreign.

Your Cost Each..... **\$1.41**

Genuine Mazda 6-Volt Edison Base Bulbs

Edison base light bulbs for use in 6-volt lighting circuits. Inside frosted.

C12255—15W. Draws 2.5A.
C12256—25W. Draws 4.2A.
Either Type, Each..... **25¢**



Foreign Plug Adapter

One end of the receptacle designed for standard American plug; other end has round type contacts to plug into foreign type socket. Made of black plastic.

C13300—Your Cost..... **17¢**

JFD Exact Duplicate Ballast Tubes



The following listing of ballast tubes will service 98% of the sets requiring replacement ballast tubes. Each tube is an exact electrical and physical duplicate of the original ballast tube, and will fit right into the set without the necessity of cutting pins, etc., and eliminate the possibility of choosing the incorrect ballast with resultant burning out of tubes, etc.

Type	Type	Type
50A2	165R4	320R1
50B2	200R	W45788
100-70	250R	W16116
100-77	300R	W16773
100-79	300R4	M86892-1
165R	320R	

C10348—Any Above Type. Specify Type. Each..... **73¢**

Type	Type	Type
1K 42B	BK 49C	K 55C
BK 42C	BK 49D	L 55B
BK 42D	K 49D	L 55C
K 42B	K 49H	L 55D
K 42C	L 49B	62A
K 42D	L 49C	K 67B
L 42B	55A	L 67C
L 42C	BK 55C	K 80B
L 42D	BK 55D	2UR224
BK 49B	K 55B	

C10349—Any above type. Specify Type. Each..... **59¢**

Amperite AC Voltage Regulator Tubes

Exact units for popular sets.

Stock No.	Amp. No.	For Use In Models
C12455	9-20	Brunswick 14, 21, 31 Brem.-Tully S81, S82
C12456	11-20	Brun. S14, S21 Brem.-Tully 82, 84
C12457	90	Majestic 90 Series
C12605	70	Majestic 70 Series

Your Cost Each, Any Above Type..... **73¢**

C12220—Amperite No. 35000. For RCA Part M86892-9. Each..... **73¢**

Variable Voltage Regulators

Designed for use with any 110 volt AC instruments to compensate for irregular line voltage. These units will fit any standard 110 volt outlet. Compact, neat appearing and well constructed, these voltage regulators will lengthen tube life in receivers and protect components. The majority of receivers used today develop troubles due to excess primary voltage. Use of these dependable regulators will insure long trouble-free service when properly adjusted. Maximum dissipation is listed below. Model 211 is wound with high quality alloy wire on an insulated metal core with the winding encased in Di-elite Adjustable five different positions. Model 211B has air cooling features which promote rapid heat dissipation. Has 8 positions.



Stock No. Type Watts Your Cost
No. No. Watts Cost
C12521 211 65 80¢
Lots of 10, Each..... 75¢
C12522 211B 150 \$1.59

BALLASTS AND RESISTOR CORDS



Reliance Ballast Resistors

For use in all AC midget sets. Stock up at this low money-saving price. Shpg. wt. 1 lb. Any type listed below.

Your Cost Each..... **54¢**
Lots of 10 (Ass't) Each..... **49¢**

No.	Type	No.	Type	No.	Type	No.	Type
C7037	14018*	C6873	K49B(115.41)	C6870	(K55D)	C7042	K80B(60-92A)
C7039	BM49B	C6874	K49C(10040)		3613	C7043	L42C(69-2037)
C7040	BM55B		(K49D)		115.53	C7044	L42D
C7041	C9266	C6875	3334	C6871	K55C(5536)		140B
C6860	2A R215		(115.28)	C6872	3614	C6876	21 R224
	L55B	C7045	L80B		(115.22)		69-2033
	K42B	C6870	(K55B)			C6877	L49C
C6859			(K55B)			C6860	L55B

*Indicates glass or metal type, 4-prong; others metal. oct.

JFD Air-Cooled Adjustable Ballast Kit



Handy new kit of adjustable AC-DC ballasts in air-cooled perforated metal tubes, designed to replace more than 2700 different types of ballast tubes. Contains 2 Type "A," 2 Type "B," and 1 Type "C" ballasts, with book giving complete instructions and replacement data. Shpg. wt. 2 lbs.

C6862—Your Cost..... **\$4.41**

REPLACEMENT TUBES FOR ABOVE KIT

C6855—Type "A" Ballast 8 Prong Octal
C6857—Type "B" Ballast 8 Prong Octal
C6858—Type "C" Ballast 4 Prong

Your Cost, Any Type..... **88¢**

J.F.D. REPLACEMENT CHART

Use Type	To Replace Types Beginning With	Numbers	Ending With
A	K,L,M or B	10 to 42	A,B,C,D,F,G or H
B	K,L,M,BK, BL or BM	45 50 105	A,B,C,D,F,G,H,S1,S2,S3
C	To replace most 4-prong types such as LX42, KX49, KX55, 1401R, 1651R and 1851R series.		

AMPERITE AC-DC Ballast Tubes

By using these fine regulators, tubes are kept to within 5% of their correct voltage, even if the line varies from 85 to 145 volts. Furnished complete with starting resistor that saves pilot lights and tubes. All KL types are octal base. *Asterisk indicates special unit.

Any Type Below, Your Cost Each..... **73¢**

No.	Type	No.	Type	No.	Type	No.	Type
C12239	3-40	C12226	250R1	C12245	KL-45*	C12234	KL-75
C12238	4P-45	C12227	320R1*	C12237	KL-75II	C12222	L55B
C12224	165R4*	C12228	L157*	C12236	KL-50II	C12221	KL50E
C12225	200R*	C12233	KL-25	C12229	KL-50S1	C12450	BK V51 DJ*
		C12235	KL-25II	C12230	KL-50S2	C12452	100-77*
		C12232	KL-45	C12223	KL-50S3		

REPLACES ALL AC-DC BALLASTS

Type	Beginning With	Numbers	Ending With
KL-25	K, L, M or BK	10 to 36	A, B, C or D
KL-25H	K, L, M or BK	10 to 36	F, G or H
KL-45	K, L, M or BK	36 to 67	A, B, C or D
KL-50II	K, L, M or BK	36 to 67	F, G or H
KL-75	BL or BM	67 to 105	A, B, C or D
KL-75II	K, L, M or BK	67 to 105	F, G or H
KL-50S1	K or L	40 to 100	S1
KL-50S2	K or L	40 to 100	S2
KL-50S3	K or L	40 to 100	S3
KL-50E	K or L	36 to 67	E

Type 4P-45—4 Prong replaces the following types:

50A2	1401R	140141	LX42B	KX49B	LX49C	KX55C
50B2	140R44	16514	LX42C	KX49C	LX49D	LX55B
50X3T	140L4	16518	LX42D	KX49D	KX55A	LX55C
140R4	140L8	165184		LX49B	KX55B	LX55D

Type 3-40—4 Prong replaces the following types:

5B	50	50XR	110R	165A	185R	KX42A
		KX49A		KX55A		

Combination Antenna Wire and AC Line Cord



Combination 3-wire 115-volt AC line cord and antenna wire. Eliminates unsightly aerial wires—makes table model radios easy to move. Special female socket will fit sets which have 3-prong male plug. Used in radios made by Sonora, Belmont, Sentinel

and Admiral. Well insulated cloth covered wire, 6 feet long. **\$1.01**
C5232—Your Cost.....

BURGESS BATTERIES

STANDARD AND HEAVY DUTY 45 Volt "B" Batteries

Super B batteries have oversized cells and are built to give maximum service. Both Regular and Super types available with Fahnestock clips or with sockets for standard battery plugs. Plugs not included.

Standard Duty 45V. (Tapped at 22½V.)

Stock No.	Burgess No.	Dimensions H. W. D.	Shpg. Wt.	Std. Pkg.	Price Each
Clip	Socket				Std. Pkg. Single
C19829	C19825	2308 7¼x8 x 27½"	8 lbs.	6	\$1.80 \$1.98

Heavy Duty 45V. (Tapped at 22½V.)

C19831	C19824	10308 7¼x8 x 1"	12 lbs.	6	\$2.19	\$2.41
C19832	C19822	21308 7¾x8½x4½"	14 lbs.	6	2.48	2.73

Light Duty Radio "B" Batteries

Binding post terminals. 5308 has insulated terminals, 4156 plain brass. All give exceptionally long service for their weight.

Stock No.	Burgess No.	Volts	Dimensions H. W. D.	Shpg. Wt.	Std. Pkg.	Price Each
						Std. Pkg. Single
C19861	5308	45	5 3/8x4 1/8x2 1/8"	4 lbs.	10	\$1.50 \$1.65
C19863	4156	22½	3 x 3 3/8x2 1/8"	2 lbs.	10	.91 1.00
C20682	A15ST	22½	3 3/8x2 1/8x2 1/8"	15 oz.	6	\$1.07 \$1.18
C20683	X30X	45	2 1/8x1 3/8x4 1/16"	12 oz.	6	2.60 2.86
C19865	Z30NX	45	3 x 1 1/8 x 4 1/16"	16 oz.	10	1.62 1.78

STANDARD "C" BATTERIES

Dependable, long life batteries especially designed for "C" supply in receivers, amplifiers, etc. Also used in test equipment.

Burgess Type 2370 and 5156 are available with either knurled top binding posts or with sockets to take standard battery plugs, Type B3BPX screw terminals. Others available only with binding posts.

Stock No.	Burgess No.	Dimensions H. W. D.	Shpg. Wt.	Std. Pkg.	Price Each
Posts	Sockets†				Std. Pkg. Single
C19866	5360	4 1/4 x 2 3/8 x 1 1/8"	1	10	\$0.30 \$0.33
C19867	C19827	2370 4 1/4 x 3 3/8 x 1 1/8"	2	10	.52 .57
C19868	5540	7 1/2 x 3 1/8 x 4 1/8"	1	10	.63 .69
C19862*	C19826	5156 22 1/2 x 3 3/8 x 4 1/16"	2	10	1.19 1.31
C20686	B3BPX	4 1/4 x 2 3/8 x 1 1/8"	2 1/2	6	.76 .84

*Has spring clips. †Tapped at 3, 4 1/2, 16, 22 1/2V. †Less plug. NOTE: Plugs for batteries above are listed at right.

IGNITION—LANTERN—TELEPHONE BATTERIES

Stock No.	Burgess No.	Volts	Shpg. Wt.	Size	Std. Pkg.	Price Each
						Std. Pkg. Single
C19858	4FH	1½	1 1/8 lbs.	2 5/8x2 5/8 x 4 5/16"	20	\$0.43 \$0.47
C19846	4F2H	3	3 lbs.	2 5/8x3 1/8 x 5 5/16"	8	.84 .92
C19837	4F4H	6	7 lbs.	2 3/4x8 1/4 x 6 5/8"	6	2.02 2.22
C19838	F4H	6	1 1/8 lbs.	2 5/8x2 5/8 x 3 3/8"	20	.47 .52
C19839	4F5H	7 1/2	8 lbs.	7 3/8x3 1/8 x 5 1/16"	6	2.45 2.69
C19841	4F6H	9	9 1/8 lbs.	8 1/8x3 1/8 x 5 1/16"	6	2.91 3.20

LITTLE NO. 6 BATTERY



Type 4FH—1½ volts. Utility type for ignition, telephone, and radio "A" service. Replaces round No. 6 cell. Size: 2 5/8 x 2 5/8 x 4 5/16". Shpg. wt., 1 1/8 lbs.

C19858—Each... 47¢
In lots of 20... 43¢ each



FLASHLIGHT CELLS

No. 1, 2 and Penlite cells constructed for intermittent use in lanterns and flashlights.

C20621—No. 1 cell. 1 1/4".

C20622—No. 2 cell. 2 5/8 x 1 1/8".

Either Above Each... 6 1/2¢

C20623—Penlite cell. 2 x 1 1/4". Your Cost, Each... 5¢

PERSONAL RADIO "A" BATTERY

Type No. 2R. Not an ordinary flashlight cell. Designed and constructed especially for use in personal radio "A" service. Will outlast regular flashlight cells when used in continuous duty service. Same size and weight as No. 2 cells listed above.

C20625—Your Cost, Each... 7¢

Lots of 192, Each... 6 1/2¢

RECOGNIZED BY THEIR STRIPES—REMEMBERED FOR THEIR SERVICE—BURGESS batteries have been used for many years by governmental departments and commercial organizations demanding superior quality and performance. There is good reason, too. These batteries are made only of the finest materials available and to the highest standard of the industry. Only high quality cells pass the acceptance tests.

Concord's terrific turn over and volume of business are assurance that you will receive only fresh, in-date batteries at the peak of their service life.

RADIO "A" BATTERIES

Stock No.	Burgess No.	Terminals	Volts	Shpg. Wt.	W-D-I-H Size	Your Cost Ea.
C19844	F2BP	Screw	3	12 oz.	2 5/8 x 1 5/8 x 4 1/8"	\$0.48
C20678	2F2BP	Screw	1 1/2	12 oz.	2 5/8 x 1 5/8 x 4 1/8"	.48
C20679	F2FBP	3	1 lb. 5 oz.	5 3/8 x 1 5/8 x 1 5/8"	.73
C20680	F4BP	Screw	6	1 lb. 6 oz.	2 1/2 x 2 1/2 x 3 1/2"	.47
C20681	44	Screw	1 1/2	10 oz.	1 1/8 x 1 1/8 x 4 3/8"	.60
C20611	422	Spring	3	2 oz.	2 3/8 x 1 1/8 x 1 1/8"	.21
C20685	B2BP	Screw	3	3 oz.	1 1/8 x 1 1/8 x 2 1/8"	.44
C19828	20F2	Screw	3v.	15 lb.	11 3/8 x 3 1/8 x 6 1/8"	3.31

"A" and "B" BATTERIES FOR HEARING AIDS

Stock No.	Burgess No.	Volts	Shpg. Wt.	Size	Std. Pkg.	Price Each
						Std. Pkg. Single

"A" Batteries						
C20688	1ES	1 1/2	2 oz.	1 1/8 x 1 1/8 diam.	60	\$0.05 1/2 \$0.07 1/2
C20689	2ES	1 1/2	5 oz.	2 1/8 x 1 1/8 diam.	96	.06 1/2 .07 1/2
C20691	TE	1 1/2	5 oz.	3 7/8 x 1 1/8 diam.	96	.16 1/2 .19
C20687	2ZE	1 1/2	1 1/2 oz.	1 1/8 x 1 1/8 x 1 1/8"	100	.13 .14

Standard "B" Batteries						
C20693	XX22E	33	7 oz.	2 1/8 x 1 1/8 x 3 1/16"	10	.96 1.13
C20694	XX30E	45	7 oz.	2 1/8 x 1 1/8 x 3 1/16"	20	1.15 1.35
C20677	U10E	15	2 oz.	1 x 3/8 x 1 1/8"	20	.52 .57
C20676	U15E	22 1/2	2 1/2 oz.	1 x 3/8 x 1 1/8"	20	.64 .70
C20675	U20E	30	3 oz.	1 x 3/8 x 2 1/8"	20	.76 .84

For Western Electric Ortho-Technic Models						
C20699	T2WE	3	9 oz.	1 1/8 x 2 1/8 x 4 1/8"	12	.49 .57
C20698	T3WE	4 1/2	12 oz.	1 1/8 x 3 1/8 x 4 1/8"	12	.58 .67



STANDARD BATTERY PLUGS

Fit any make of dry battery. Check specifications carefully. When in doubt, give make and model number of battery on your order so that we can determine the correct type of plug you will require.

No.	Illus.	Description	Used With	Ea.	Lots 10 Ea.
C20591	(1)	3-prong "B"	45 V. "B" Batteries.....	9c	\$0.81
C20592	(2)	3-prong "C"	4 1/2 V. "C" Batteries.....	10c	.90
C20593	(3)	5-prong "C"	22 1/2 V. "C" Batteries.....	16c	1.44
C20590	(4)	2-prong "A"	4 1/2 V. "A" Batteries.....	5c	.35
C20595	(5)	2-prong "B"	4 1/2 V. "A" Batteries.....	5c	.35
C20596	(6)	3-prong "B"	Portable "B" Batteries.....	7c	.50
C20597	(7)	4-prong "A&B"	Comb. 1 1/2 V. "A" & 90 V. "B".....	7c	.50
C20598	(8)	2-prong "A"	6 V. "A" Batteries.....	5c	.35
C20599	(9)	4-prong "A&B"	Comb. 6 V. "A" & 90 V. "B".....	8c	.72

PORTABLE "A" BATTERIES

Stock No.	Burgess No.	Volts	Size			Ever-ready	Ray-o-Vac.	Shpg. Wt., Lbs.	Std. Pkg.	Price Each	
			L	W	H					Std. Pkg.	Single
C19854	2F	1 1/2	2 5/8	1 1/8	4 3/8			1	6	\$0.39	\$0.43
C19850	4F	1 1/2	3 1/8	2 5/8	4 1/8	742	P94A	2	12	.63	.69
C20625	2R	1 1/2	2 5/8	1 1/8	4 3/8			4 oz.	192	.065	.07
C20610	G3	4 1/2	4 1/8	3 1/8	1 1/8	746	P83A	2	12	.46	.51
C19842	F4P1	6	2 5/8	2 5/8	4		P694A	2	12	.63	.69
C20613	2F4L	6	3 3/8	2 1/8	10 1/4	747	P698L	4	6	1.26	1.39
C19843	G5	7 1/2	3 1/8	2 1/8	4 3/8	687	P85A	3	6	.77	.85
C19828	20F2	3	1 1/8	3 1/8	6 1/8			15	1	3.31	3.31
C20626	T5	7 1/2	2 1/8	2 1/8	3 3/16			1 1/4	6	.87	.96

PORTABLE "B" BATTERIES

C20627	XX45	67 1/2	1 3/8	2 1/8	4 3/8	467	4367	1	12	1.71	1.88
C20612	A30	45	3 1/8	2 1/8	4 1/8		430P	3	6	1.50	1.65
C20614	B30	45	2 5/8	4 1/8	5 5/8	762	P5303	3	12	1.50	1.65
C20616	Z30	45	3 1/8	2 1/8	4	738	P7R30	2	6	1.80	1.98
C20617	M30	45	5 5/8	3 1/8	1 1/8	482	P5830	4	12	1.50	1.65
C20615	XX30	45	2 1/8	2 1/8	3 3/16			12 oz.	12	1.23	1.35

COMBINATION PACKS FOR PORTABLES AND FARM USE

C19871	5DA60	1 1/2 & 90	5 3/8 x 2 1/8 x 6 1/8"	5	3.25
C19874	6FA60	1 1/2 & 90	11 1/8 x 6 1/8 x 2 1/8"	AB84	3.35
C19875	4GA12	1 1/2 & 63	9 1/2 x 2 1/8"	AB419	2.46
C20618	G4B50	6 & 75	4 1/8 x 1 1/8 x 2 1/8"		3.15
C20624	6TA60	1 1/2 & 90	9 1/8 x 2 1/8 x 4 3/8"		3.60
C20620	G6B60	9 & 90	13 1/8 x 4 1/8 x 2 1/8"		3.74
C19872	F6A60	7 1/2 & 9A, 9A, 90B	9 5/8 x 2 1/8 x 4 1/8"	AB994	3.35
C19873	D5A60	7 1/2 & 9A, 90B	9 5/8 x 2 1/8 x 4 3/8"		3.55
C19876	2F4B60	6A, 90B	10 5/8 x 4 1/8"		4.59
C19877	F5M45	7 1/2 & A			
		67 1/2 & B	9 5/8 x 2 1/8 x 4 1/8"		2.95
C20619	17GD60	1 1/2 & 9A, 90B	15 1/8 x 4 1/8 x 7 1/8"	748 AB82	5.62

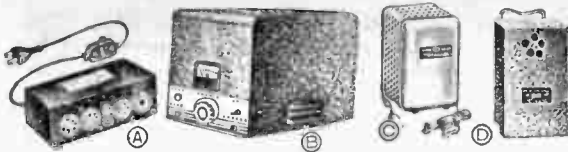

SELENIUM Battery Eliminator

(A) Designed to replace "A" and "B" batteries in portable and farm set so that they may be used in the home directly from the house current. Provides completely filtered and humfree reception. Excellent for modernizing all battery receivers using from 4 to 7 tubes. Operates from 110 volt, 60 cycle a. c. lines. Contain no liquids and can be used in any any position. As easy to install as batteries. Universal sockets for all types of battery plugs. Uses no tubes. Supplies "A" and "B" power for farm or portable sets using 4, 5 or 6 tubes. Delivers 1.5 v. "A" and 90V. "B" voltage. Size 2 1/2 x 4 1/2 x 6 3/4". Shpg. wt. 5 lbs.

C15708— \$9.85

Your Cost Same as above but uses tube rectifier.

C15704— \$8.82

STANCOR Model 752 Power Pack

(B) Provides well filtered 6 volt DC. 12.5 amp. supply for automobile radio servicing or sales demonstration, effectively operates push button tuning auto sets, for industrial and laboratory testing. All controls, knobs, voltmeter and terminals located on front panel. Can also be used for battery charging, magnetic field exciting and electroplating. Operates on 110 volts, 60 cycle.

C17240— \$43.90

Your Cost

GE "One-Day" 6-Volt Charger

(C) Modern design, compact construction for farm and home use. Selenium rectifier type giving highly efficient and extremely quiet operation. Delivers 7 to 4 amperes tapering charge. Equipped with durable AC cord, DC leads with battery clips, and pilot light to indicate operation. Capacity 3 cells. Dimensions 7 1/4" x 5" x 5" depth. For 115 volt 60 cycle. Shpg. wt. 7 lbs.

C15695— \$10.99

Lots of 6, ea. 9.53

GE "Overnite" 6-Volt Charger

(C) For car, truck and tractor batteries. Similar to "One Day" model but for use where higher charging rate is required. Delivers 12 to 7 amperes tapering charge, will charge the average discharged battery in 12 hours or less. Dimensions 7 1/4" x 5" x 6". Shpg. wt. 8 lbs.

C15697 Your Cost \$16.13

Lots of 6, each 13.98

5-Amp. Tungar Charger

(D) Model 6R326A1 for charging any 6-volt battery. Delivers 5 amperes and tapers off as battery charges, preventing damage to cells due to overcharging. Has receptacle for attaching to car and ammeter so that battery can be charged without removing it from car. With tube and all accessories. For 110 v., 60 cyc. A.C. Shpg. wt., 13 lbs.

C15699— \$15.68

Your Cost

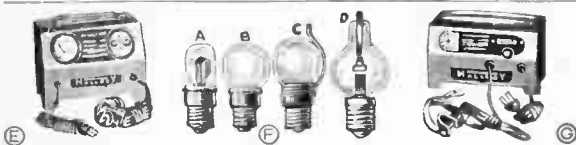

Model 6AC6 6-Volt Charger

(E) Delivers 6 to 4 amperes tapering charge. Employs dry-disc rectifier. Has circuit breaker and large meter indicating rate of charge. 6x8 1/2 x 4 1/2". With AC cord, DC cord and receptacle for dash mounting. 115v. 50/60 cycle AC operation. Shpg. wt. 7 1/2 lbs.

C15698— \$10.42

Model 6AC10 6-Volt Charger

(E) 10 to 7 ampere charging rate which will completely charge a battery overnight. Employs a dry-disc rectifier, larger meter, circuit breaker and provision for thorough ventilation. With 6-ft. AC cord, 6-ft. DC cord and receptacle for dash mounting. Size: 6 3/4" x 10 1/2" x 5 3/4". 115 v. 50/60 cycle AC. Shpg. wt. 12 lbs.

C15700— \$13.03

Your Cost

Model 12AC5 12-Volt Charger

(E) Heavy duty charger for 12-volt batteries as used in aircraft, trucks, boats, buses, etc. Charging rate 5 to 3 amperes. Employs dry disc rectifier, meter, circuit breaker, and provisions for thorough ventilation. Complete with AC cord, DC cord and receptacle for dash mounting. Size: 6 3/4" x 10 1/2" x 5 3/4". Shpg. wt., 12 lbs.

C17217— \$18.26

Your Cost

TUNGAR Bulbs

(E) Used in battery chargers, "A" eliminators, etc. Can replace rectifier bulbs of equal rating. 2 lbs.

Type	GE No.	Rating	Each
(A)	289881	.6 Amp	\$2.94
(B)	12X825	.2 Amps.	2.94
(C)	206501	.2 Amps.	2.94
(B)	20X372	5 Amps.	3.67
(D)	189019	6 Amps.	3.67
(D)	217283	15 Amps.	7.35

Tungar-Type Bulbs

(B)—2 amp., less tip.	C21907— Your Cost \$2.25
(C)—2 amp., with tip.	C21906— Your Cost \$2.25
(D)—6 amp.	C21908— Your Cost \$2.55
(D)—15 amp.	C21909— Your Cost \$4.50
(D)—20 amp.	C21910— Your Cost \$11.25

6-Volt Battery Booster

(C) Type 6AC4 Drydisc rectifier type. 4 to 2 amperes tapering charge. Has external circuit breaker with quick front reset. Perforated for thorough ventilation. With 6-ft. cord for light socket and a 4-ft. cord with clamp-on receptacle for dash mounting. Dimen.: 4 1/2" x 7 1/2" x 3 3/4" deep. Finished in black wrinkle. For 115 volts, 50/60 cycle a.c. operation. Shpg. wt. 5 lbs.

C15696— \$7.81

Your Cost

BATTERIES CHARGERS FLASHLIGHTS

RCA BATTERIES

RCA batteries are the preferred type and are being used more and more where dependable service is required. All standard size batteries are manufactured to fit every sort of application. Though small in size they are extremely rugged in construction and will give many extra hours of service. Made in modern factories with high precision equipment these batteries all meet exacting specifications. All plug-in type except VS001 standard flashlight cell and VS016 which has snap terminals.

Portable "A" Batteries

Stock No.	Type No.	Volts	Size Inches	Sim. to Burgess	Shpg. Wt. Ea.	Your Cost
C20709	VS036	1 1/2	2 3/4 x 1 1/8	4F	4 oz.	\$0.08
C20703	VS001	1 1/2	2 5/8 x 2 5/8 x 4 1/2	6F	2 lbs.	.63
C20704	VS007	1 1/2	3 1/2 x 2 5/8 x 4 1/2	8FL	2 lbs.	.87
C20705	VS008	1 1/2	3 7/8 x 1 7/8 x 10 3/4	G-3	3 lbs.	1.19
C20706	VS002	4 1/2	4 x 1 1/2 x 4 1/2	F4P1	1 1/2 lbs.	.52
C20707	VS009	6	2 3/8 x 2 5/8 x 4 1/2	2F4L	2 lbs.	.66
C20708	VS011	6	3 7/8 x 1 7/8 x 10 3/4		3 lbs.	1.26

Portable "B" Batteries

C20715	VS014	45	3 7/8 x 2 1/4 x 4 1/2	A-30	3 lbs.	1.61
C20716	VS013	45	3 3/16 x 1 1/2 x 5 7/16	M-30	3 lbs.	1.50
C20717	VS012	45	4 1/8 x 2 1/8 x 5 5/16	B-30	3 lbs.	1.50
C20719	VS015	45	3 x 2 3/8 x 4	Z-30	1 1/2 lbs.	1.80
C20720	VS055	45	2 5/8 x 1 x 3 1/2	XX-30	3/4 lb.	1.55
C20718	VS016	67 1/2	2 1/4 x 3 5/8 x 1 5/16	XX-45	1 lb.	1.71

Farm "A" Batteries

C20722	VS024	1 1/2	7 3/4 x 2 1/4 x 7 1/8	20F	10 lbs.	2.31
C20723	VS025	3	12 x 4 x 6 1/2	20F2	15 lbs.	3.42

Farm "B" Batteries

C20724	VS027	45	8 1/2 x 4 1/2 x 7 1/8	10308P1	12 lbs.	1.87
C20725	VS026	45	8 1/2 x 3 1/2 x 7 1/8	2308P1	8 lbs.	1.75

Farm "A-B" Battery Pack

C20729	VS022	1 1/2	9-9A-90B 15 3/4 x 1 1/4 x 6 7/8	17-GD-60	22 lbs.	5.62
--------	-------	-------	---------------------------------	----------	---------	------

Portable A-B Battery Packs

C26730	VS019	7 1/2	9-90 2 1/2 x 9 1/4 x 4 7/16	F6A60	6 lbs.	3.68
C20731	VS047	9-90	13 7/8 x 1 1/2 x 2 1/8	G6B60	8 lbs.	3.74

Flashlight Batteries

C20700	VS001	1 1/2	2 3/8 x 1 1/8	2	2 oz.	.06 1/2
C20701	VS033	1 1/2	1 7/8 x 1 1/8	1	1 1/2 oz.	.06 1/2
C20702	VS034	1 1/2	2 x 3 7/8	Z	1 1/2 oz.	.05

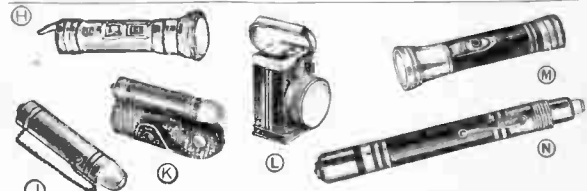

BURGESS Rangefinder Flashlight

(H) Heavy chromium barrel two-cell flashlight, non-rolling head prevents accidents, beveled plate lens concentrates light, resists breaking. Heavy brass reflector. Three position on-off switch, thumb operated rangefinder focus control. Uses two Burgess No. 2 flashlight batteries. Less batteries.

C20578— Your Cost \$1.65

MICRO-LITE Miniature Flashlights

(J) Model 502 C has burnished goldite finished case with glossy black or flame red bands. Comes with key chain attached. Push button switch. Uses one penlite cell and GE No. 112 lamp.

C20560— 40¢

Each \$4.32

Model 500 same as above but without key chain.

C20561— 33¢

Each \$3.60

Model 201K combines miniature Micro-lite decorated in attractive enameled colors, on solid brass. With leather key case. Push-button switch.

C20562— 40¢

Each \$4.32

BURGESS TW2 Lantern

(L) Handy, powerful light for the sportsman and farmer. Throws clear beam for quarter of mile. Focusing type polished reflector, easy to operate thumb switch. Compact and light weight. Uses one Burgess 4F2H, 3-volt battery. Less battery.

C20579— Your Cost \$1.99

BURGESS Flashlight

(M) Modern styled, seamless brass barrel. Lock-off switch with flasher position. Long range spot beam pre focused lamp, uses two Burgess No. 2 flashlight cells. Less batteries.

C20580— \$1.06

Your Cost

Baby tubular is smaller in size, does not have flasher switch position. Otherwise same as above. Uses two Burgess No. 1 flashlight cells. Less batteries.

C20581— 91¢

Your Cost

BURGESS Penlight

(N) Sturdy rich maroon and chrome metal case with pocket clip and lock-on switch. Uses two Burgess No. Z penlight batteries. Less batteries.

C20582— Your Cost 59¢

TUBE AND SET TESTERS



WESTON Model 798 Mutual

Conductance Tube Checker and Analyzer

(A) Good-Bad or Mutual Conductance reading for all type receiving tubes. Volt-Ohmmeter-Milliammeter section with most commonly used ranges for trouble-shooting. AC and DC volts 0-15/150/750, DC Milliampers 0-7.5/150, Ohms 0-100,000/1,000,000, 1,000 ohms per volt sensitivity on all AC and DC operations. 3% accuracy on DC and 5% on AC. Wrinkle finished case with test-lead and tool compartment at left. Detachable hinged cover. Internal battery furnished for ohmmeter operation. Complete with Test Leads. For 105-125 volts, 60 cycles. Size: 17 $\frac{3}{4}$ "x11 $\frac{1}{2}$ "x6 $\frac{1}{2}$ ".

C21646—Your Cost.....\$204.05

SIMPSON Model 330 Tube Tester

(B) For testing tubes in terms of percentage of rated dynamic mutual conductance. 4 $\frac{1}{2}$ " meter with colored dial indicates good, fair, bad and doubtful. Sockets provided for all types of tubes. Ten push button and nine rotating switches provide infinite combinations in tube element and circuit selection. Tube chart for quickly identifying tubes and setting controls. Reset button returns all controls to normal position after use. Size: 15 $\frac{1}{2}$ "x9 $\frac{1}{2}$ "x6 $\frac{1}{2}$ ". Shpg. wt. 16 lbs.

C21714—Your Cost.....\$96.53

Model 330RCP

Same as above but with built-in roll chart.

C21719—Your Cost.....\$110.25

Model 305

(C) Emission type tester with 3 way switches makes it possible to test any type tube regardless of base or internal connections. Neon short tester. Line control from 100 to 130 volts. Size: 8x10 $\frac{1}{2}$ "x5 $\frac{1}{2}$ ". Shpg. wt. 12 lbs.

C21711—Your Cost.....\$48.51

Model 305RCP

Same as above but with built-in roll chart.

C21708—Your Cost.....\$58.31

GENERAL ELECTRIC Model YTW-1 Tube Checker

(D) Tests all receiving type tubes on emission principle. Extreme flexibility achieved through the use of element switches, allowing each element in a tube under test to be individually and independently connected to either side of the filament supply, high or low side of B supply or disconnected entirely from all circuits. High speed roll chart placed beneath switches to indicate automatically correct position of each. Designed to expose immediately a tube with an open filament without usual warm-up period. Protected by fuse on front panel. 4 $\frac{1}{2}$ " meter with "Replace, Doubtful and Good" sections in color. 1000 ohms per volt DC voltmeter with ranges of 0-10/100/1000 volts. Modern, attractive steel case surfaced in grey wrinkle finish. Size: 17 $\frac{3}{4}$ "x12 $\frac{1}{2}$ ". Shpg. wt. 15 lbs. For use on 105-130 volts, 50/60 cycles.

C21581—Your Cost.....\$59.50

EMC Mutual Conductance Tube Tester

Checks mutual conductance of all tubes from .75 to 117 filament volts on a calibrated Micromho scale, as well as on a "Reject-Good" scale. Detects both shorted and open elements, checks for gas content. Complete switching flexibility allows all present and future tubes to be tested regardless of location of elements on tube base. Checks individual sections in multi-purpose tubes. Tests for radio frequency and other noises. Individual sockets for each tube base type eliminate possible errors. Attractive four-color panel and large easy-to-read 3" meter.

(E) Model 200AC

In Sloping counter case. 12x11 $\frac{1}{2}$ "x5". Shpg. wt. 15 lbs.

C21582—Your Cost.....\$48.51

(F) Model 200AP

In hand-rubbed carrying case with compartment for storage of leads, etc. 12 $\frac{1}{2}$ "x15x5 $\frac{1}{2}$ ". Shpg. wt. 18 lbs.

C21583—Your Cost.....\$52.77

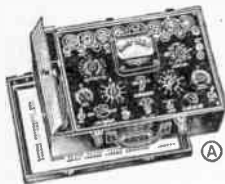

PRECISION Model 920P Tube and Radio Analyzer

(A) A complete service laboratory including a dynamic mutual conductance type tube tester, battery tester and 33 range AC-DC multi-range set tester. Tests all type receiving tubes, all types portable dry batteries under proper load conditions, indicates when to replace. Roll type chart. AC and DC voltage measurements to 3000 volts, 1000 ohms per volt on both. DC measurements to 12 amps. Resistances to 10 megohms. Decibel readings to +64 db. Output readings to 3000 volts. Size: 12x13x6". Shpg. wt. 20 lbs.

C21700—Your Cost.....\$82.54

Model 912P Tube and Battery Tester

Same as Model 920P but less set testing feature. Shpg. wt. 19 lbs.

C21702—Your Cost.....\$59.98

PRECISION Model 954P Tube, Battery, Set Tester

Same as Model 920P but with the following features: 20,000 ohms per volt DC meter, AC and DC voltage ranges extended to 6000 volts, Resistance ranges to 60 Megohms, Decibel ranges to +70 db, DC Microamp 0/60/300.

C21584—Your Cost.....\$97.22

PRECISION Model 915 Tube and Battery Merchandiser

(B) Tube and battery testing features same as Model 920P, but with case and external features designed for merchandising tubes and batteries. 9" square meter with easy reading three-colored scale indicating Replace-Weak-Good. Full vision roller tube chart. Attractively finished in black ripple with chromium trim and meter lamp reflector. Case of heavy gauge steel. Size: 23" high, 16" wide. Bottom depth 10", tapers to 4" at top. Shpg. wt. 30 lbs.

C21585—Your Cost.....\$82.72

SUPREME Model 504B Tube and Set Tester

(C) Small compact unit combining functions of tube tester, multimeter, condenser checker and battery condition tester. Checks all tubes including loktals, octals, miniaturs, pilot lites, television video amplifier tubes. New tube data supplied by Mir. for one year at no extra charge. Rotary tube chart and ArrowWay indicator system. Rheostat line adjustment. Section checks may be made on multi-section tubes. Large 4" meter with Good-Bad reading in addition to other ranges. Push-button selector system. Measures DC volts 0 to 2500 volts in ranges at 1000 ohms per volt. AC volts in 5 ranges from 0 to 1000 volts. DC current ranges of 0-500 micro-amp, 0-2.5/10/50/250 ma. and 0-1-10 amps. Lowest reading 10 microamperes. Output volts measured in 5 ranges 0 to 1000 volts. No external condenser necessary. Ohmmeter with 5 ranges of 0-200/2000/20,000 ohms and 0-2/20 megohms. Lowest reading .1 ohm. Condenser tester covers electrolytics and papers including high voltage filters and low voltage high capacity bypass condensers. Checks under normal working voltages. Battery tests provide proper load for most commonly used A and B batteries. Condition of battery is read on English Scale. For use on 100-133 volts, 50/60 cycles. Size: 14 $\frac{1}{2}$ "x12 $\frac{1}{8}$ "x4 $\frac{3}{8}$ ". Shpg. wt. 20 lbs.

C21678—Your Cost.....\$87.71

SUPREME Model 599A Tube and Set Tester

(D) Emission type tube checker with patented Double Filament Return selector system which is your guard against obsolescence. New tube data supplied by mir. at no extra cost. Roller chart, Arrow-Way indication system. Ranges: 0-6/15/150/600/1500 volts DC at 1000 ohms/volt., 0/15/150/600 volts AC, 0-6/60/600 Milliampers. Output volts 0 to 600 volts. Resistance to 20 megohms in 4 ranges. Paper condenser checks on high resistance range. Dry-battery check. 1.5/4.5/6/45/90 volts under load. Portable model. 11 $\frac{1}{8}$ "x8 $\frac{3}{8}$ "x5 $\frac{1}{8}$ ". Shpg. wt. 12 lbs.

C21754—Your Cost.....\$61.25

Model 589A Tube and Battery Tester

Same as Model 599A but less set testing features. Shpg. wt. 10 lbs.

C21753—Your Cost.....\$47.97

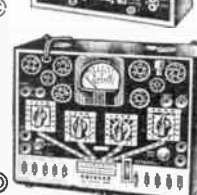



TUBE AND SET TESTERS

HICKOK Model 534 Tube and Set Tester

(A) All purpose mutual conductance tube tester and set tester. Tests all receiving type tubes under actual operating conditions. Voltage ranges 0-20/200/500/1000/5000 volts AC and DC. 20,000 ohms per volt sensitivity 1K, 1000 ohm per volt AC. Resistance from 0.1 ohms to 100 megs in 3 ranges. No batteries needed. Capacitance checks from .0001 to 100 mfd. Checks leakage of electrolytics and paper condensers. Inductance checks to 100 henries with or without DC component. -10 to +50 DB scale. For 110 volts, 60 cycles. Size: 17x18x8 $\frac{1}{2}$ ". Shpg. wt. 35 lbs.

C21452
Your Cost **\$138.30**

Model 532P. Similar to Model 534 but less set testing features.

C21454—Your Cost **\$121.20**

HICKOK Model 538

All Purpose Tube and Set Tester

Similar to Model 534 but with additional features, accuracy, dependability of particular interest to the exacting technician and laboratory engineer. Especially valuable for use at electronic installations where equipment and human safety depend on positive, accurate, operation.

C21586
Your Cost **\$215.76**

RCP Model 802N Tube and Set Tester

(B) A compact service shop ready to take out on the job. Tests all receiving type tubes with jack for noise test. 4 $\frac{1}{2}$ " meter with large Good-Bad-Doubtful section for tube testing. Clear, easily read figures for set testing. Portable battery test. Tests paper, mica and electrolytic capacitors for leakage. Ranges: 0-10/50/500/1000 volts DC or AC at 1000 ohms per volt. DC milliammeter 0-1/10/100/1000 ma., 0-10 amperes. Ohmmeter 0-500/5000/100,000 ohms, 1-10 megohms, 100,000 ohm range battery operated. Decibel measurements from -8 through +55db. Output meter 0-10/50/500/1000 volts. In hand-some hand rubbed hardwood carrying case with compartment and self-latching cover, battery and test leads. Size: 13x9 $\frac{1}{2}$ x5". Shpg. wt. 15 lbs. for 100-130 volts, 50/60 cycles.

C21587
Your Cost **\$58.31**

Rolindex Tube Chart Model 103

(D) Tube testing data at a glance. Designed to fit snugly in tool compartments of RCP Models 322, 322P and 802N. Crackle finish steel case. 3x8x2 $\frac{1}{4}$ ". Shpg. wt. 4 lbs.

C21588
Your Cost **\$7.35**



R.C.A. RIDER Chanalyst

(A) Permits systematic method of analysis on any type radio receiver. Any point tested without interrupting operation of receiver. Various conditions can be determined at tube elements while signal is present. Checks presence or absence of signal, operating and control voltages. Operation of various types of filter circuits checked at radio, intermediate and audio frequencies. Locates failures in minutes instead of hours and solves the problem of intermittents quickly and more positively than any other method. Locates origin of hum. Identifies oscillating AF stages and finds sources of noise. Complete with test leads prods and complement of 12 tubes. Gray crackle finish, steel case with carrying handles. 9x16x10 $\frac{1}{4}$ ". Shpg. wt. 28 lbs.

C21666
Your Cost **\$162.50**

JACKSON Model 655 Audio Oscillator

(Not illustrated.) Provides both AF for radio and sound work, and **supersonic** for bactericides, homogenizers, sonar, etc. 20-200,000 cps in 4 ranges, accurate to 3%. Permanently locked calibration of the R-C tuned circuit, no zero adjust. necessary. Fundamentals only, no harmonics. Transformer-coupled or resistive outputs, impedances 10/250/500/5000 ohms or "High." Output continuously variable. Output power with transformer coupling from 20 to 20,000 cps is $\frac{1}{2}$ watt. Flat response curve, ± 1 db from 30 to 15,000 cps with transformer coupling. Less than 5% waveform distortion from 30 to 15,000 cps. Hum down 60 db from maximum. Stable, large line-voltage changes do not affect frequency, waveform, or output voltage. Comes complete with its 5 tubes installed. 13x9 $\frac{1}{2}$ x9 $\frac{1}{2}$ ". Shpg. wt. 30 lbs.

C21602
Your Cost **\$122.50**

TRIPLETT Model 3413 Tube Tester

(C) Multi-purpose test circuit provides for emission test, short and open element test and transconductance comparison test for matching tubes. Tests all receiving tubes, gaseous rectifiers, ballasts and pilot lamps. Neon short indicator. Meter indicates whether tubes are Good, Bad or Doubtful. Built-in roll chart. For 110 volts, 60 cy. Size: 10x10x5 $\frac{1}{2}$ ". Shpg. wt. 12 lbs.

C21603
Your Cost **\$53.65**

(E) Counter-style model of above, Triplett No. 3212.
C21485
Your Cost **\$62.23**

JACKSON 637 Dynamic Tube Tester

(F) Combination tube tester and multimeter. Tests all receiving and television amplifier tubes and has two spare socket positions, spare switch positions and circuits for use if new tubes are announced. "Dynamic" method finds poor tubes which might otherwise indicate good. High plate voltages used for accurate results. All readings direct on Good-Bad scale. Jacks provided for audible noise tests. Includes ballast-tube and neon continuity testers. Push buttons select ranges with minimum of test-prod relocating. DC and AC voltmeter ranges cover 0-2500 volts in 6 ranges with 1,000 ohm/volt sensitivity. DB's from -10 to +54 in 3 ranges. DC milliammeter, 0-1/10/100/250. DC ammeter, 0-10. Ohmmeter, 0-30 meg in 3 ranges. Complete with test prods and self-contained battery, in case with removable hinged lid. Dimensions 14 $\frac{1}{2}$ x13 $\frac{1}{2}$ x6". Shpg. wt. 14 lbs.

C21601
Your Cost **\$87.71**

RCP "Dynoptimum" Tube Tester

(G) Model 322. Easy to operate. Exclusive "Dynoptimum" circuit requires only 5 controls. Permits accurate checking of wide variety of old or new tubes, including the new miniature and sub-miniature receiving types. Provisions for checking individual sections of multi purpose tubes. Jack provided for headphone tests of tube noises. Neon lamp for quick tests of shorts and leakage between elements. Operates on 100-130 volt, 50 to 60 cycle AC power supply. Model 322 is open-face, in black crackle steel cabinet with sloping panel. 5 $\frac{1}{2}$ x12 $\frac{1}{4}$ x7". Shpg. wt. 11 lbs.

C21599
Your Cost **\$37.19**

Model 322P in steel carrying case with detachable cover. Shpg. wt. 13 lbs.

C21600
Your Cost **\$41.11**

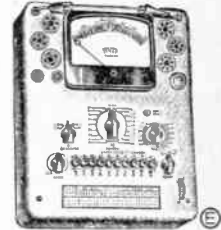
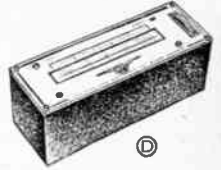

MEISSNER Analyst

(B) New, Improved. Most modern complete servicing instrument on the market. Locates faults by signal tracing method. Five separate channels, all of which may be operated at the same time, 4 range electronic voltmeter, wide range audio test channel, oscillator troubleshooter channel, 95-1700 KC RF-IF test channel and line current indicator channel. Controls accurately calibrated. Aligned and laboratory tested. Complete with 12 tubes and ready for service. 110 volt, 60 cycle. Includes test cables, prods and instruction book. Size: 9 $\frac{1}{2}$ x13 $\frac{1}{2}$ x10 $\frac{1}{2}$ ". Shpg. wt. 35 lbs.

C21706
Your Cost **\$111.57**

Analyst Manual

Contains a general discussion of the Analyst and its capabilities; schematic circuit; instructions on servicing any receiver.

C19994
Your Cost **25¢**

HICKOK 156 Indicating Traceometer

(C) Permits operator to rapidly trace signal through receiver from antenna to speaker. Operator of RF, mixer, local oscillator, IF, detector, discriminator, limiter, AF and power supply can be checked simultaneously and without changing a test lead. Separate meters for each of five channels. Built-in speaker for monitoring of IF, RF, or AF channels. Vacuum tube voltmeters cannot be damaged by overloads. Wattmeter permits measurements of power consumption from 0 through 150 watts. No test leads necessary. For operation on 105-125 volts, 50/70 cycles. 14x16 $\frac{1}{2}$ x11". Shpg. wt. 32 lbs.

C21590
Your Cost **\$160.20**

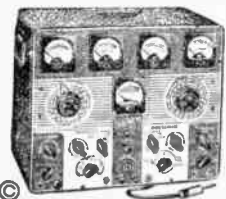
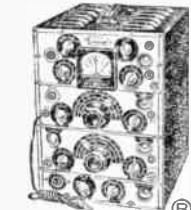

ELECTRONIC MULTITESTERS

RCA VoltOhmyst Model 195-A

(A) High values of resistance can be measured, constant protection against meter burn-out. Ranges: 0-5/10/50/100/500/1000 DC volts at input impedance of 10 megs.; 0-5/10/50/100/500/1000 AC volts on a linear scale; 0-1000/10,000/100,000 ohms/1 meg./10 megs./1000 megs. by using internal source of 3 volts, as an AF voltmeter has frequency response from 30 cycles to 100 KC. Input impedance 200M ohms plus 170 mmfd. 0-5/10/50/100 volts. -20 to +62 db. readings equivalent to volume units for a reference level of 1 milliwatt across 600-ohm line. FM alignment indicator with plus or minus meter reading. New style easily read meter face. $9\frac{1}{2} \times 6\frac{1}{2} \times 6\frac{1}{2}$ ". Shpg. wt. 14 lbs.

C21771—Your Cost.....\$79.50

RCA Crystal Probe

(B) Designed for converting the DC circuit of any Volt-Ohmyst to read AC so that voltages up to a frequency of 100 megacycles are indicated directly on the DC scale.

C21775—Your Cost.....\$8.95

SUPREME Model 565 V. T. Voltmeter

(C) A balanced highly degenerative bridge circuit. Negligible frequency error from 50 cycles to 100 megacycles. All ranges selected by push buttons. Zero adjustment control. Four-inch full-vision type meter. Fuse protected. Ranges: DC volts 0-1/2.5/10/50/250/500; AC volts 0-1/2.5/10/50/250. Input resistance: DC—80 megohms on 1-volt range, 40 megohms on 500-volt range; AC—40 megohms on 1-volt range, 20 megohms on 250-volt range. Audio frequency voltages up to 20,000 cycles may be measured. The input capacity of the probe is 5 MMFDS. Attractive metal case with a hinged cover. Size: $9\frac{1}{2} \times 9\frac{1}{2} \times 4\frac{1}{2}$ ". Shpg. wt. 11 lbs. 110-125 volts AC. 50/60 cycles.

C21682—Your Cost.....\$62.23

TRIPLETT Model 2450 Analyzer

(D) Electronic Volt-Ohm-Milliammeter. Long scale 6" meter with three color markings. Full line voltage compensation. 51 megohms impedance on DC. Low frequencies loading equal to 8 megohms, 35 mmf. High frequency loading equal to 8 megohms, 5 mmf. Detachable probe furnished. Ranges: AC and DC volts; 0.25/10/50/250/500/1000; DC milliamperes 0-1/1/10/50/250/1000; Ohms 0-1000 (midscale 10)/10,000/100,000; Megohms 0-1/10/100/1000; Capacity in MFD; 0-.005/.05/5/5/50. Two voltage regulator tubes. Metal case finished in brown hammered enamel. Brown leather strap handle, nickel plated hardware and rubber feet. $10 \times 10 \times 5\frac{1}{2}$ ". Shpg. wt. 14 lbs. 90-130 volts, 60 cycles.

C21564—Your Cost.....\$97.51

ELECTRONIC DESIGNS V-T Volt Ohmmeter

(H) The Model 100. Extreme care in the matching and choice of component parts has resulted in a high quality test instrument. DC Ranges: 0-3/10/30/100/300/1000 volts. All ranges have a constant input resistance of 11,000,000 ohms. Accuracy 3%±. AC Ranges: 0-10/30/100/300/1000 volts. 1,000 ohms per volt sensitivity with accuracy of 5%±. Electronic Ohmmeter Ranges: 0-1000/10,000/100,000 ohms; 1 meg/10 megs/1000 megs. This extremely neat meter is complete with signal tracer probe, two test leads and batteries. $9\frac{1}{2} \times 6\frac{1}{2} \times 4\frac{1}{2}$ ". Shpg. wt. 10½ lbs. 110-120 volts, 50-60 cycles.

C21710—Your Cost.....\$52.50

EDIPROBE for use with Model 100 or other VTVM. C21703—Your Cost.....\$7.00

SILVER "VOMAX"

(J) True vacuum tube voltmeter. Complete measurements and visual signal tracing can be done on all AF, AFC, AVC, IF, and RF circuits, over a frequency range of 20 cycles through over 100 MC, by withdrawable RF diode probe and test leads. Ranges: with zero adj. 0-3/12/30/120/300/1200 VDC at 51 megohms and 0-7.5/30/75/300/750/3000 VDC at 126 megohms, 0-3/12/30/120/300/1200 VAC at 6.6 megohms and 8 mmfd., 0-2-2K/20K/200K ohms and 2/20/2000 megohms, 0-1.2/30/120/300/1200 MA and 12 amps. DC, and -10 to +10/+30/+50 DB. Polarity reverse switch on front panel separate ohms zero adj. Five non-confusing scales on $4\frac{1}{2}$ " meter face, meter fully protected from overloads. 115 V 50/60 cycle operation. Size: $12\frac{1}{2} \times 7\frac{1}{2} \times 6\frac{1}{2}$ ". Shpg. wt. 13 lbs.

C21540—Your Cost.....\$59.85

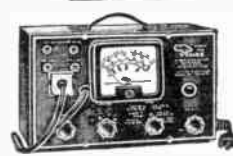
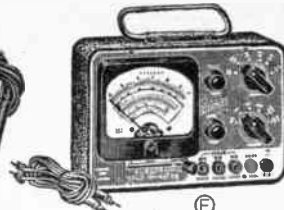
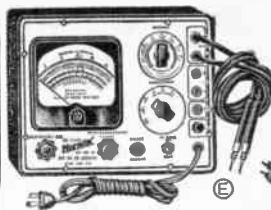

HICKOK Model 203 Electronic Multitester

(E) Compact universal test instrument for AC-DC volts, Ohms, DC milliamperes, Capacity and Inductance. Ideal for alignment of FM and Television receivers. Circuit prevents damage to meter. Voltage regulated power supply. Ranges: Volts AC or DC 0-3/12/30/120/300/1200, Mills (dc) 0-3/12/30/120/300/1200, Capacity 0-100,000 mmf. in 2 ranges, 0-1000 in 5 ranges. Inductance 50 mh.—100 henries and Ohms 1 ohm-10,000 megohms in 7 ranges. AC to approx. 5 megacycles may be measured. Input impedance 15 megohms on DC, 12 megohms on AC. For 105-125 v., 50/70 cycles $9 \times 11\frac{1}{2} \times 7$ ". Shpg. wt. 18 lbs. Satin chrome panel. Blue baked lacquer case.

C21453—Your Cost.....\$84.60

HICKOK Model 214 Volt-Ohmmeter

(F) Compact, self-contained, battery operated electronic volt-ohmmeter. No warm-up. Always ready for instant use. Time switch automatically shuts off battery at end of 4 minutes. May be shut off manually. AC and DC voltage measurements from 0 to 1200 in 6 ranges. 15 megohm constant impedance. (10 mmf. on AC.) Resistance from 0 to 1000 ohms in six ranges. Meter electronically protected against burn-out. Clear, easily read meter scales. $8\frac{1}{2} \times 6\frac{1}{2} \times 4\frac{1}{2}$ ". Shpg. wt. 9 lbs. Finished in 11anmertex blue lacquer. With batteries.

C21565—Your Cost.....\$59.40

PRECISION EV-10MCP V-T Multi-Range Tester

(G) $8\frac{1}{2}$ " meter and a voltage regulated power supply. Ranges: eight zero-center vacuum-tube volt-meter ranges 0/3/6/12/60/300/600/1200/6000 volts at 13 to 133 meg. input resistance; six circuit probing zero-center ranges, sensitivity as above, using coaxial cable for measurement in AVC, AFC, FM and television circuits. 0/3/6/12/60/300/600 volts; resistance 0/2000/200,000 ohms and 0/2/20/200/2000 megohms; eight A.C. and D.C. voltage ranges at 1000 ohms/volt to 6000 volts D.C. current 0/600 microamps., 0/3/12/60/300/1200 ma. 0/12 amperes; output ranges from -26 to +70 db. Shpg. wt. 20 lbs.

C21765—Model EV-10MCP in black ripple metal case with handle. $12 \times 10\frac{1}{2} \times 6$ ".

Your Cost.....\$79.50

Model EV-10P, as above, in hardwood portable case.

C21766—Each.....\$81.46

RF-10 PROBE: for Precision EV-10. For measurement of R.F. and U.I.F. voltages. With 955 acorn tube.

C21784—Each.....\$13.04

WESTON Model 769 Analyzer

One instrument providing a conventionally Volt-Ohm-Milliammeter with self-contained power source, a high impedance electronic Volt-Ohmmeter using 115 volt, 60-cycle power and a stable, probe type vacuum tube voltmeter for use up to 300 Megacycles. When used as a standard analyzer, there are available six 10,000 ohm/volt DC ranges to 1200 volts, six 1000 ohms/volt rectifier type AC voltage ranges to 1200 volts, three ohmmeter ranges to 200,000 ohms and six DC current ranges to 600 MA—all without use of external power. Using 115 volt, 60 cycle power, it is a 15 megohms input resistance electronic DC volt-ohmmeter with ohmmeter ranges extended to 2000 megohms. As an AC vacuum tube voltmeter with ranges of 3 to 120 volts, frequency coverage extends from 50 cycles to 300 megacycles, is completely isolated from any DC influences. All tubes including RF diode are standard commercial types. Input resistance is 5 megohms, 5 mmfd. Special DC probe. In hardwood carrying case with cover. Test leads also furnished. $10 \times 13 \times 6\frac{1}{2}$ ". Shpg. wt. 15 lbs.

C21566—Your Cost.....\$173.25

RCP Electric Multitester Model 668

(K) A portable, highly accurate instrument. Matched resistors. Capacity meter reads directly in microfarads. Entire instrument thoroughly shielded. AC and DC vacuum tube voltmeter direct reading with input impedance of 16 and 160 megohms, .00005 mfd. 0-3/6/30/150/600/1500/6000 volts. Signal and output voltages from 10 c.p.s. to 10,000 c.p.s. Ohms from 1 ohm to 1000 megohms. .00005 to 2000 mfd on direct reading meter. Ready to operate in wrinkle finish steel case. $9\frac{1}{2} \times 9\frac{1}{2} \times 7\frac{1}{2}$ ". Shpg. wt. 7½ lbs.

C21793—Your Cost.....\$73.01

ANALYZERS MULTITESTERS

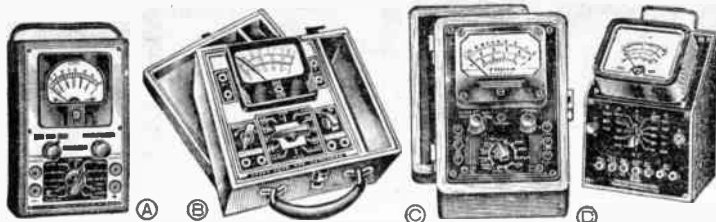

PRECISION Model 832S

(A) This compact 31 range tester measuring only $7 \times 4 \frac{1}{2} \times 3$ " and utilizing a $3 \frac{1}{2}$ " square 800 microampere meter has the following scales: D.C. voltage ranges at 1000 ohms per volt; 0-6, 0-30, 0-150, 0-300, 0-600, 0-1200. A.C. volt ranges at 500 ohms per volt: 0-12, 0-60, 0-300, 0-600, 0-1200, 0-2400. D.C. current: 0-12, 0-12, 0-120, 0-600 milliamperes. Resistance ranges: 0-5000 ohms, 0-500,000 ohms, and up to 5 megs. by using an external battery. Decibels: -10 to +60. Output ranges: 0-12-60-300-600-1200-2400 volts. Furnished in a walnut case, complete with test leads and internal battery. Shpg. wt. 3 lbs.
C21657—Your Cost.....\$23.49

PRECISION Model 844P

(B) Single rotary master range selector. Large $4 \frac{1}{2}$ " rectangular meter. Ranges: AC and DC volts 0-12/60/300/600/1200/6000 at 1000 ohms/volt; DC milliamperes 0-1.2/12/60/300/1200 and 0-12 amps.; 0/400/100,000 ohms and 0-1/10 megs. Decibel ranges from -12 to +70; Output 0-12/60/300/600/1200/6000 volts. Hardwood case with cover. H.V. test leads and batteries. $9 \times 10 \times 6 \frac{1}{2}$ ". Shpg. wt. 9 lbs.
C21656—Your Cost.....\$36.13

WESTON Model 779-1 Analyzer

(C) DC voltage ranges at a sensitivity of either 1000 or 20,000 ohms/volt. Precision resistors used. Ranges: AC and DC volts, 0-2.5/10/50/250/1000; DC current 0-1/1/10/50/250 milliamperes; 0-1/10 amps.; 0-3000/30,000/300,000 ohms and 0-30 megohms; 1 cibe.; -14 to +54. Solid oak case. $6 \frac{1}{2} \times 9 \frac{1}{2} \times 4 \frac{1}{2}$ ". Shpg. wt. 6 lbs.
C21647 Approx.....\$89.25

CHICAGO INDUSTRIAL Model 458

(D) $5 \frac{1}{2}$ " rectangular meter set at 45 degree angle to facilitate reading. 1000 ohms per volt all DC ranges. DC volts, 0-5/10/50/100/500/2000. AC volts, 0-12.5/25/125/250/1250. DC milliamps, 0-1/10/100. AC milliamps, 0-2.5/25/250. Ohms full scale 1000/200,000/2,000,000. Output -5 to +55 db. Enclosed standard 22½-volt Battery supplies test current. Furnished with test leads and battery. Specially treated aluminum instrument panel is mounted on a welded steel case, finished in harmonizing brown wrinkle, equipped with rubber feet and collapsible handle for portability. $10 \frac{1}{2} \times 6 \frac{1}{2} \times 5 \frac{1}{2}$ ". Shpg. wt. 8 lbs.
C21567—Your Cost.....\$25.48

SUPREME Model 567 Speed Set Tester

(J) Deluxe Portable set tester. Push-button operated Direct current measurements 0 to 100 microamperes, 1 to 500 ma. and 1 to 50 amps. in 9 ranges. AC current in 3 ranges: 0 to 50 amps. Total of 14 DC voltage ranges, 7 each at 1000 and 20,000 ohms per volt to cover 0-5/25/100/250/500/1000/5000 volts. AC voltage ranges: 0-5/25/100/250/500/1000/5000 volts at 1000 ohms per volt, with same ranges for output measurements. No external capacitor required. Calibrated for 500 ohms line when working with DB measurements. 5 ranges -10 to +49 db. 7 resistance ranges. Low ohms: two ranges of 0-5 and 0-5 full scale. High ohms: 0-500/5000/500M/5 meg./50 meg. All ranges operated on self-contained batteries. Sturdy steel carrying case in grey wrinkle. $9 \frac{1}{2} \times 9 \frac{1}{2} \times 5 \frac{1}{2}$ ". Shpg. wt. 14 lbs.
C21570—Your Cost.....\$62.13

RCP Model 447P Multi-Tester

(K) 1000 ohms/volt. DC volts 0-5/50/250/500/2500. DC Ma. 0-1/10/100/1000. DC amps. 0-1/10. AC volts 0-10/100/500/1000. Ohms 0-500/100M/1 Meg. DB -8 to +55. Output ranges same as AC volts. Size: $3 \times 8 \frac{1}{2} \times 5 \frac{1}{2}$ ". Shpg. wt. 5 lbs. In hardwood case with compartment and cover. Test leads and battery supplied.
C21721—Your Cost.....\$21.51

Model 447

Same as above but in open face hardwood case.
C21722—Your Cost.....\$17.59

RCP Model 461AP Multi-Tester

20,000 ohms per volt sensitivity on all DC measurements. AC sensitivity 1000 ohms per volt. AC & DC voltmeter with ranges of 0/2.5/10/50/250/1000/5000 volts each. 0-10/100/500 DC milliamperes, 0-100 DC microamperes. Ohmmeter has ranges of 0-2000/200,000/ohms and 0-20 megohms. Decibel meter with readings from -10 to +55 db. In attractive natural grain hardwood case, self latching cover and compartment for test leads. With test leads and self-contained batteries. $8 \times 7 \frac{1}{2} \times 4 \frac{1}{2}$ ". Shpg. wt. 6 lbs. (Not illustrated.)
C21571—Your Cost.....\$42.63

TRIPLETT Model 2405

(E) 5.6" scale for greater accuracy. 0-10/50/250/500/1000 volts AC and DC, 25,000 ohms/volt on DC, 1000 ohms/volt on AC. 0-5/1/5/10 AC amps., 0-10 DC amps. 0-1/10/50/250 DC ma., 0-50 microamperes. 0-4000/40,000 ohms=0-4/40 megohms on self-contained batteries. Condenser in series with AC volts ranges. Db ranges from -10 to +55 db. Capacity check of paper condensers. In portable, metal case with detachable cover. $10 \times 10 \times 5 \frac{1}{2}$ ". Shpg. wt. 13 lbs.
C21482—Your Cost.....\$55.61

TRIPLETT Model 625NA

(F) Multi-range, dual sensitivity. Large 6" meter with mirrored scale. Ranges: DC volts 0-1.25/5/25/125/500/2500 at 20,000 ohms per volt, 0-2.5/10/50/250/1000/5000 at 10,000 ohms per volt. AC volts 0-2/5/10/50/250/1000/5000 at 10,000 ohms per volt. DC microamps 0-50, DC milliamps 0-1/10/100/1000, DC amps. 0-10. All DC current measurements at 250 MV. Resistances 0-2000/200,000 ohms/40 megs. Direct reading decibel ranges from -30 to +69 db. Compact portable molded case 6" high x 5½" wide x 2½" deep. Leather carrying strap, test leads, alligator clips and instructions. Shpg. wt. 12 lbs.
C21475—Your Cost.....\$44.10

Attractive black leather carrying case for above.
C21476—Your Cost.....\$5.14

G-E YMW-1A Unimeter

(G) Rapid, correct measurements of ohms, volts, current and decibels. Single rotary switch controls all ranges 4½" meter. DC functions 20,000 ohms/volt, AC 1000 ohms/volt. Ranges: AC and DC volts 0-2.5/10/50/250/1000. 3 resistance ranges from 1 ohm to 20 megohms. DC current scales from 0 to 500 ma. and 0 to 50 microamps. Db scale from -4 through +62 db. 0 level is 1 mw. in 600 ohms. With test leads. In portable carrying case of fabricated steel finished in grey wrinkle. $10 \frac{1}{2} \times 9 \frac{1}{2} \times 4 \frac{1}{2}$ ". Shpg. wt. 11 lbs.
C21568—Your Cost.....\$39.50

High Voltage Multiplier Type YYW-1

(H) Lead and prod for measuring up to 10,000 volts. Ideal for checking television high-voltage supplies.
C21569—Your Cost.....\$18.75

TRIPLETT Model 2002 Dual Appliance Tester

(L) Test power consumption of radios, small motors and household appliances under running conditions. Permits watts and line volts to be read simultaneously. Scale black on white, 2¼" at outer arcs. AC-DC Watts: 0-1500-3000 at 10 amps. rated, 15 amps. max. AC-DC Volts: 0-130-260 volts at 125 ohms per volt. In heavy leather case with snap button cover and leather handle. Ample space for connecting cords (Furnished). $6 \frac{1}{2} \times 4 \frac{1}{2} \times 3 \frac{1}{2}$ ". Shpg. wt. 4 lbs.
C21572—Your Cost.....\$27.93

SIMPSON Model 390 Appliance Tester

Small compact meter for testing all types of AC single phase motors and appliances. Ranges: 0-150/300 VAC; 0-3/15 amps. AC; 0-300/600/1500/3000 Watts AC. Has 3" meter with easily read scales. Volts read in normal position. amps. or watts read by pressing respective button on the panel. Complete with break-in plugs. Black bakelite case. Size: $3 \times 5 \frac{1}{2} \times 2 \frac{1}{2}$ ". Shpg. wt. 4 lbs. (Not illustrated.)
C21705—Your Cost.....\$38.71

Model S-10-A

POCKETSCOPE Oscilloscope

(M) Complete with synchronization means and self-contained power supply. Use for study of wave shapes, measurement of modulation, frequency, phase shift, voltages, power, distortion-adjustments of audio-amplifiers, radios, television and FM receivers. Cathode ray tube magnetically shielded. Controls placed to permit easy adjustment. Response of vertical and horizontal amplifiers within -2 db from 20 cycles to 100 KC and within -6 db to 200 KC. Vertical and horizontal sensitivity 1 volt RMS/inch; input resistance, 5 megohm; input shunt cap. 36 mfmfd.; input series capacitance 1 Mfd. 600 volt. Linear time base oscillator 10 cycles to 50 KC with sweep from left to right. Uses miniature glass tubes and 2AP1 Cathode Ray Tube. $6 \frac{1}{2} \times 4 \times 10$ ". Shpg. wt. 7 lbs.
C21719—Your Cost.....\$64.68

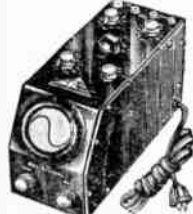
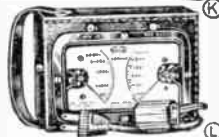
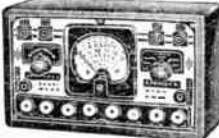
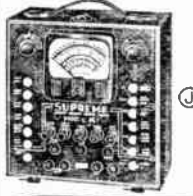
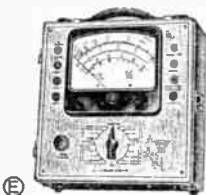

POCKET-SIZE MULTITESTERS

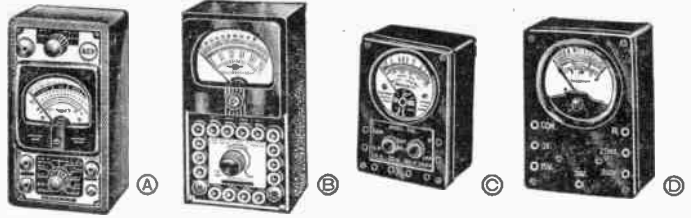

RCP Model 420-S

(A) Basic meter is 0-400 microamperes, accurate to within 2%. Voltages multipliers are metallized matched pair resistors having a tolerance of 1%. DC volts, 0-2.5-10-50-250-1000-6000. DC milliamperes, 0-1-10-100-1000. Ohmmeter, 0-500-100,000-1,000,000. AC volts, 0-10-50-250-1000-5000. Output volts, 0-10-50-250-1000-5000. Decibel meter: minus 10 to plus 69 Decibels. $6\frac{1}{2} \times 3\frac{1}{2} \times 3\frac{1}{2}$ ". Shpg. wt. 3 lbs.

C21723—Your Cost. \$23.03

MODEL 449

(B) Basic meter is 0-200 microamperes, accurate to within 2%. Sensitivity 5000 ohms per volt. DC volts, 0-5-50-250-1000. AC volts, 0-5-50-250-1000. Output volts, 0-5-50-250-1000. DC MA, 0-5-10-100-1000. Ohms: 0-2000/20,000/.2 meg./2 meg. Decibels: -6 to +10, -11 to +26, -28 to +40, -40 to +52. DB ranges calibrated for 500-ohm line. Chart supplied for other inputs. $6 \times 3 \times 2\frac{1}{2}$ ".

C21724—Your Cost. \$24.01

CHICAGO INDUSTRIAL INSTRUMENT Miniature Model 450A

(C) Ideal for service where compactness and precision are required. Dustproof construction with sealed jacks and bakelite case this unique meter has sensitivity of 1000 ohms per volt. Multipliers are held to within 1%. Includes two standard penlight cells. Ranges: 0-5/10/50/500/1000 volts DC; 0-1 milliamperes DC; 5000/50,000/500,000 ohms full scale, 30/300/3000 ohms center scale. Size: $3\frac{1}{2} \times 2\frac{1}{2} \times 2$ ". Shpg. wt. 2 lbs.

C21506—Your Cost. \$10.68

Model 451A

Similar to above but for use on both AC and DC at 1000 ohms per Volt, all ranges.

C21507—Your Cost. \$14.60

Model 451B

Same as Model 451A but 2500 ohms per volt sensitivity.

C21580—Your Cost. \$16.27

Model 452A

A sensitive compact 100 microampere meter providing 10,000 ohms per volt sensitivity on all voltage ranges. 0-10/50/100/500/1000 volts DC; 0-2000/20,000/200,000/2,000,000 ohms full scale, 30/300/3000/30,000 ohms center scale. Shpg. wt. 2 lbs.

C21508—Your Cost. \$14.60



SUPREME Model 542B

(A) A pocket size laboratory that incorporates a highly sensitive meter. Has pin jack terminals, includes the following ranges: 4 DC mil. ranges of 0-0.3, 6, 30 and 150; 4 DC volt ranges of 0-6, 150-300 and 1500; 4 ohm ranges of 0-2000, 20,000, 200,000 and 2 megs.; 4 AC volt ranges of 0-6, 30, 150 and 600; 4 output ranges of 0-6, 30, 150 and 600; 4 decibel ranges of -6 to +10, +8 to +24, +22 to +38 and +34 to +50. Uses a full-size 3" meter with a rugged, accurate 200 microampere movement and a knife-edge pointer. Sensitivity of 5000 ohms per volt! All resistance ranges are operated by batteries furnished with the unit. Housed in sturdy Bakelite case. Size: $5\frac{1}{4} \times 3\frac{1}{2} \times 2\frac{1}{2}$ ". Shpg. wt. 2 lbs.

C21732—Your Cost. \$23.18

Model 543B

Similar to above but 1000 O.P.V. Ranges: 0/2000/200,000 ohms; 0/6/60/600 DC MA; 0/15/150/600/3000 volts AC and DC. Shpg. wt. 2 lbs.

C21745—Your Cost. \$18.57

EMC Model 100 Voltmeter

(B) Pocket meter of 1000 ohms per volt sensitivity. AC and DC voltage ranges of 0-3/12/60/300/1200/6000 volts. DC current ranges of 0-6/6/60/600 milliamperes. Resistance ranges of 0-3000/300,000 ohms and 0-30 megohms. 4 db ranges from -10 to +48. AC volts from 25 cycles to 1 megacycle with no temperature errors. Bakelite panel mounted in wood case prevent any voltage breakdowns between panel and case when measuring high voltage. $6\frac{1}{2} \times 3\frac{1}{2} \times 3\frac{1}{2}$ ". Shpg. wt. 3 lbs.

C21575—Your Cost. \$21.51

CHICAGO INDUSTRIAL INSTRUMENT Portable Volt-Ohm Milliammeters

Model 371

(D) Strictly a DC meter, its ranges are as follows: 0-3/15/30/300 volts, 0-25 milliamperes and a resistance scale of 0 to 10,000 ohms. Operates on two standard flashlight cells which are included. Size: $1\frac{1}{2} \times 2\frac{1}{4} \times 3\frac{1}{4}$ ". Shpg. wt. 3 lbs.

C21504—Your Cost. \$5.14

Model 312

Similar to above but for use on both AC and DC volts: 0-25/50/125/250; Milliamperes to 50 mils.; up to 100,000 ohms. For use on 110 volt AC or DC.

C21505—Your Cost. \$6.61

Model 431

(E) 400 microampere meter mounted on an etched aluminum panel, and set in a black wrinkle metal case. Inclosed flashlight battery. Ranges include: 0-15/150 volts AC—1000 ohms per volt; 0-30/300/1500 volts DC—2500 ohms per volt; 0-150 milliamperes DC; 3000/300,000 ohms full scale; 35/3500 ohms center scale. With 48" test leads. Size: $5\frac{1}{2} \times 2\frac{1}{2} \times 2\frac{1}{2}$ " overall. Shpg. wt. 3 lbs.

C21501—Your Cost. \$16.27

Model 421

(F) $2\frac{1}{2}$ " 650 microampere meter. 0-7.5/15/150/750/1500 volts AC and DC—1000 ohms per volt; 0-7.5/75 DC. milliamperes; 5000/500,000 ohms full scales; 35/3500 ohms center scale. A copper-oxide rectifier. Ranges are brought out to silver-plated jacks, with engraved identification. Battery and 48" test leads included. Shpg. wt. 3 lbs. Size: $5\frac{1}{2} \times 3$ " overall.

C21500—Your Cost. \$21.02

Model 432

(G) Three-inch square 100 microampere meter. Sensitivity of 10,000 ohms per volt on all ranges. Four DC voltage and four resistance ranges. Volts DC: 0-3/30/300/600. Ohms full scale: 0-2000/20,000/200,000/2,000,000. With test leads and battery. $5\frac{1}{2} \times 3\frac{1}{2} \times 3\frac{1}{2}$ ". Shpg wt. 1 lbs.

C21573—Your Cost. \$21.02

Model 433

Same as Model 432 but 50 Micro-ampere meter movement for 20,000 ohms per volt on all voltage ranges. Ohms full scale: 0-5000/50,000/500,000/5,000,000.

C21574—Your Cost. \$22.93



TRIPLETT Model 666HH Pocket Meter

(H) (Above). 1000 ohms per volt. "RED DOT" life-time meter. 0-10/50/250/1000/5000 volts AC and DC, 0-10/100/500 milliamperes, DC at 250 MV. and 0/2000/400,000 ohms, center scale 12/2400. Black milled case and panel. Complete with battery and 50" test leads and clips. Size: $3\frac{1}{2} \times 5\frac{1}{2} \times 2\frac{1}{2}$ ". Shpg. wt. 3 lbs.

C21576—Your Cost. \$19.60

Carrying case for above. Heavy duty sewed leather with strap handle.

C21577—Your Cost. \$3.92

SIMPSON Model 240 Hammeter

(C) Completely self-contained. Sensitivity of 1000 ohms per volt. Ranges: 0-15/150/750/3000 AC volts, 0-15/75/300/750/3000 DC volts, 0-15/75/300/750 DC milliamperes, 0-3000/300,000 ohms. Center scale 30/3000 ohm accuracy 3% on DC and 5% on AC. All figures engraved and filled with white enamel. Meter of shock-proof hridge type construction with soft-iron pole pieces. Matched resistors. Test leads furnished. Size: $3 \times 5\frac{1}{2} \times 2\frac{1}{2}$ ". Shpg. wt. 3 lbs.

C21579—Your Cost. \$21.31

SIMPSON Model 260

(D) Black Bakelite Roll top safety case. Accurate full scale readings. Ranges: Volts AC and DC 0-2.5/10/50/250/1000/5000 at 20,000 ohms/volt DC and 1000 ohms/volt AC. Output AC volts 0-2.5/10/50/250/1000/5000 DC. Microamps 0-100, Milliamps 0-10/100/500. DC Amp 0-10 DB, five ranges from -10 to +52 db. Ohms: 0-2000/200,000 and 0-20 megohms, center scales 12/1200/120M. $5\frac{1}{2} \times 7 \times 3$ ". Shpg. wt. 3 lbs.

C21578—Your Cost. \$42.87

Same as above but without roll-top case. **\$38.17**

C21713—Your Cost.



RCP Model 710 Pocket Signal Generator

(A) A real signal generator small in size, accurate in calibration, sufficient output—all at very low cost. Can be conveniently slipped into the pocket and taken out on the job for quickly locating and localizing faults so that you may give an immediate, accurate repair estimate. Broadcast band alignment provided for by fixed frequencies of 1500 KC and 550 KC. IF alignment by using fixed frequencies of 456 and 465 KC. Suitable trimmers for recalibrating. Safe AC or DC operation. Complete with tubes, shielded output cable, line cord and plug. Attractive wrinkle finished case. 3x6x2½". Shpg. wt. 2 lbs. **C21596**
Your Cost \$17.59

(B) Wide range from 95 KC to 100 MC. Fundamental frequencies in five bands are continuously variable from 95 KC to 25 MC. Self-contained modulator source is 400 cycle sine wave generator which modulates the carrier at 30% or 80% as desired. 400-cycle frequency also available for external use. Alignment of FM "1F" stages is accurately obtained by means of zero discriminator current method. Five step ladder attenuator controls voltage from zero to maximum. Frequency calibration is accurate to 2% up to and including broadcast band and 3% for the high frequency bands. All coils not in use are automatically shorted. Individual shielding of RF circuits, coil assemblies and attenuator insures stable operation. High ratio planetary drive tuning condenser with choice of vernier or direct drive for ease of operation. Operates on 110-130 volt, 50/60 cycle. In handsome, black/crackle finished steel housing with white enamel highlights and carrying handle. 8x11½x5". Shpg. wt. 13 lbs.
C21720—Your Cost \$48.51

SILVER FM/AM

(C) Eight fundamental ranges, direct frequency calibrated to 1% accuracy, 90 KC through 170 MC. RC audio oscillator provides 400 cycle AM modulation, variable from 0 to nearly 100%. FM 90 KC through 210 MC with built-in electronic FM sweep variable from 0 to 500 KC. Output continuously variable from less than 1 microvolt, to over 1 volt. Metered output, dual variable and 4 position ladder attenuators, complete rotary shielding, 4 section line filter, coils mounted in rotary turret. 10:1 vernier dial. Permits design and service of AM and FM receivers by aural, meter or visual alignment methods. Complete with 105/125 volt, 50/60 cycle built-in mains-isolating power supply, tubes, output cable and terminal box. 6 ft. cord and plug. Size: 12¾" long, 7¾" high, 5¾" deep. In grey steel cabinet with leather carrying handle. Shpg. wt. 14 lbs.
C21542—Your Cost \$99.50

HICKOCK Model 288X

(A) Model 288X. High degree of accuracy for servicing amplitude and frequency modulated and television equipment. Fundamentals used throughout entire range of 100 KC to 110 MC on AM output and 100 KC to 160 MC on FM output. Variable audio output: 0 to 15 KC is produced by heterodyne type oscillator. Decibel meter provides convenient means of measuring power and voltage and determining resonance in alignment work. A 110 KC and 1000 KC crystal controlled signal, accurate to 0.01% unmodulated or modulated at 400 cycles is available. By using harmonics of the crystal controlled oscillator, accurate signals up to 125 MCs are obtained in multiples of 100 KC and 1000 KC. Complete with all tubes, necessary cables, instruction manual. For 110 volts, 50/60 cycles. 14x16½x8". Satin chrome finish panel and blue baked lacquer finished case. Shpg. wt. 30 lbs.
C21455—Your Cost \$159.06

MEISSNER Signal Calibrator

(B) Portable self-contained unit designed to generate marker signals at 10, 50 and 100 KC intervals over the RF range of 10 KC to 20 MC. Push-button control of frequency. Radio transmitters, receivers and laboratory equipment easily and accurately set to a desired frequency. Unknown frequencies positively and quickly determined. Component parts mounted on a single chassis to which front panel is attached. All controls mounted on front panel. Incorporates a precision type quartz crystal operating on 100 KC. Easily adjusted by front panel control to exact frequency. Output signal may be amplitude modulated at 60 cycles by front panel control. For operation on 115 volt, 50/60 cycle source. Size: 8½x8½x12¼". Shpg. wt. 19 lbs.
C21707—Your Cost \$77.17

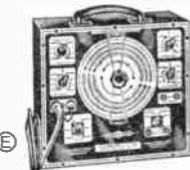
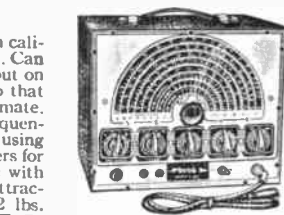

SIGNAL GENERATORS

APPROVED ELECTRONIC Model A-200

(D) Extremely stable signal generator covering long wave, broadcast and short wave. RF from 100 KC to 25 MC in six bands of fundamentals and 19 MC to 75 MC in two bands of harmonics. Internal modulation of 4-10 c.p.s. variable from 0 to 100%. RF and AF oscillators of new highly stable design. For 110 volt, 60 cycle. Size 8x10x12". Shpg. wt. 19 lbs.
C21709—Your Cost \$39.50

PRECISION Model E200C

(E) Units are individually hand calibrated to better than 1% on all 8 bands which range from 88 KC. to 120 MC. Fundamentals to 30 MC. Direct reading; no charts needed. Large full vision 6½" no-glare dial with a 0-1000 point vernier scale allowing direct reading to one part in 1000. 400 cycle sine-wave audio oscillator provides modulation and external test signal from zero to 50 volts. Complete shielding including electrostatically shielded transformer and AC line is RF filtered. 0-100% modulation control more than triples signal utility. 110 volt, 50/60 cycle. Black ripple finished, heavy gauge portable steel case. 10½x12x8". Shpg. wt. 20 lbs.
C21715—Your Cost \$62.87

SUPREME Model 576

(F) Compact Signal Generator incorporating electron coupled circuit giving great stability. Iron core coils. Leakage minimized by double shielding. RF ranges from 65 to 20,500 kilocycles and harmonics to 82 megacycles. Audio frequency: 400 cycles—voltage output continuously variable from minimum to maximum. Internal modulation at approximately 50% on RF carrier. Jack provided for external modulation. 115 volts, 60 cycles. 9½x8½x7¾". Shpg. wt. 19 lbs.
C21667—Your Cost \$67.57

SIMPSON Model 315

(G) Designed for extreme accuracy, great stability, minimum leakage and good wave form. 9" meter type dial with knife edge pointer for high readability and close settings. 30% modulation at 400 cycles. Six bands from 75 KC. to 30 MC. with frequency accuracy of 1%. Volume level of each step of the ladder type attenuator is regulated by a smooth non-inductive control which provides RF output from microvolt to 1 volt and 400-cycle output from 0 to 5 volts. Coils, attenuator and signal selector are individually shielded. Effective line filter and line cord shield for negligible leakage. Coils individually calibrated at the factory. Designed to retain original inductance regardless of temperature or humidity changes. In fully enclosed welded metal case. 16x10x6". Shpg. wt. 20 lbs.
C21712—Your Cost \$66.00
Model 415. Eight bands—70 KC to 130 MC, 0-100% modulation from 60 c.p.s. to 10 KC.
C21716—Your Cost \$112.70

HICKOK Crystal Controlled Microvolt Signal Generator

Model 191X. (Not illustrated). Accurate, dependable source of calibrated radio frequency test voltages ranging from 125 KC to 120 MC on fundamentals. 8" dia. dial. Signal leakage kept at minimum by use of newly developed cast aluminum attenuator. Vacuum tube voltmeter for accurate and direct calibration of RF output from ½ microvolt to 100,000 microvolts. Modulation 30% at 400 cycles fixed, and 0.70% at 400 cycles, and variable. Provisions made for external modulation from 5 to 10,000 cycles. Decibel meter for power determination. Provision made for measuring both input and output of unit under test. For operation on 105-125 volts, 50-70 cycles. Satin chrome finish panel with Blue baked lacquer finished case. 13 dimensions 14x16½x8". Shpg. wt. 31 lbs.
C21450—Your Cost \$145.92

TRIPLETT Model 2432

(C) Extremely accurate Signal Generator employing large etched metal dial with 4½" total length made up of 6 arcs approximately 330 degrees each. Output connections on the front panel use the coaxial type fittings—one for AF and one for RF. Voltage regulated power supply provides for greater accuracy. Six bands are used: 75-224, 220-750, 700-2500, 2450-8500, 8000-25,000 and 24,000-50,000 kilocycles. Output attenuators provide coarse and fine control through two shielded resistor networks. Circuit selector provides for internally modulated signal (30% at 400 cycles), unmodulated signal or 400 cycle audio. Enameled finished case with rubber feet. Size: 10x10x6¾". 110 volts, 60 cycles. Shpg. wt. 15½ lbs.
C21484—Your Cost \$86.73

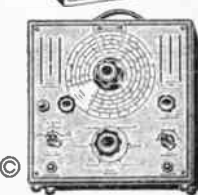
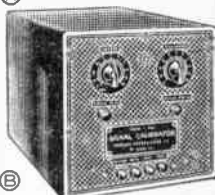

CATHODE-RAY OSCILLOSCOPES

RCA 3-Inch Model 155C Oscilloscope

(A) Employs 906P1 tube and two 6SJ7's for vertical and horizontal amplifier stages, one 6C8G timing oscillator stage and two 5Y3GT/G rectifier tubes; total of 6 tubes. Bar knob controls all located on front panel. 20 volts (RMS) per inch deflection without amplifier; 0.5 volt (RMS) per inch with amplifier. Amplifier response flat from 10 to 60,000 c.p.s. Amplifier gain 40 db. Timing frequency from 10 to 60,000 c.p.s. Operates on 110 volts, 50/60 cycles a.c. Wrinkle lacquer metal case has etched panel. Size: 15x8x14". Complete with tubes and instructions. Shpg. wt. 32 lbs.

\$115.00
C21447—Your Cost.....

DUMONT 3-Inch Oscillograph Model 164E

(B) Employs either 3AP1 or 3AP5 tube. Amplified sweep circuit over continuous range from 15 to 30,000 cycles. Input impedance vertically: 1,000,000 ohms; horizontally: 800,000 ohms. Max. potential 400 DC volts. Deflection sensitivity: max. vertical 0.80 r.m.s. volt/in.; max. horizontal 0.85 r.m.s. volt/in. Frequency range: vertical and horizontal/amp. both uniform within 20% from 5 to 100,000 cycles. Handy deflection-plate terminals available at rear. Horizontal amp. may be switched to amplify either sweep circuit or external signal, so that Lissajou patterns for frequency determination may be employed. 115 volts, 40-60 cycles. Size: 11 1/2x7 1/2x14". Shpg. wt. 25 lbs.

\$115.00
C21557—Your Cost.....

DUMONT 5-Inch Model 208B

(C) Uses 5LP1 tube. Has a calibrated removable scale. Frequency range: Y-axis, plus or minus 10% from 2 to 100,000 sinusoidal cycles; X-axis, plus or minus 15% from 2 to 100,000 sinusoidal cycles. A voltage gain of 2000 times on the Y-axis and 43 times on the X-axis. Deflection sensitivity: max. Y-axis 0.010 r.m.s. volt/in. Max. X-axis 0.500 r.m.s. volt/in. Direct deflection plates—21 and 22 r.m.s. volts/in. Y-axis and X-axis respectively. Recurrent sweep over continuously variable range from 2 to 50,000 cycles. 110 volts, 40-60 cycles. 14 1/2x8 1/2x19 1/2". Shpg. wt. 67 lbs.

\$270.00
C21782—Your Cost.....

G-E Type CRO-3A 3-Inch Oscilloscope

(G) Ideal for accurate and rapid service work. Entirely portable and compact. Designed for general radio servicing. Sweep rates from 20 to 30,000 per second in seven ranges. Fine adjustment vernier. Vertical and horizontal sensitivity .3 volts RMS/inch. 500 volts RMS maximum input either amplifier. Input impedance vertical is 1 meg., 45 mmf., horizontal 1 meg., 50 mmf. Equipped with 3AP1 cathode ray tube with green screen. All controls conveniently located on front panel. Vertical amplifier frequency response 20 cycles to 100 KC ±10% (sinusoidal). Horizontal 20 cycles to 70 KC ±10% (sinusoidal). Horizontal 20 cycles to 70 KC ±10% (sinusoidal). Welded steel case in gray wrinkle finish. Etched aluminum front panel. Size: 8x12 1/2x13". Shpg. wt. 30 lbs. With tubes. For 115 volts, 60 cycles.

\$98.50
C21592—Your Cost.....

G-E Type CRO-5A 5-Inch Oscilloscope

(H) Designed primarily for studying voltage and current wave forms. May also be used to study any variable which can be translated into electrical potentials by means of associated apparatus. All amplifier and sweep DC potentials are electronically regulated to give a stable trace even under adverse power line variations. Input impedance: Vertical—1.25 meg.—50 mmf. Horizontal 3.3 meg., 32 mmf. Maximum input potential 5 or 500 volts RMS on vertical and 5 volts RMS on horizontal. Sensitivity: vertical—.02 volts RMS/inch, horizontal .2 volts RMS/inch. Vertical amplifier frequency response from 20 to 350,000 cycles (sinusoidal). Horizontal amplifier from 20 to 200,000 sinusoidal cycles. Both amplifiers flat within -10%. Sweep generator 20 to 20,000 cycles in five steps. Sync control internal, external or 60 cycles. Retrace is blanked. Direct connections available at rear of cabinet. 14x8x19". Shpg. wt. 45 lbs. For use on 105-125 volts, 60 cycles. Complete with tubes.

\$195.00
C21593—Your Cost.....



(A)



(B)

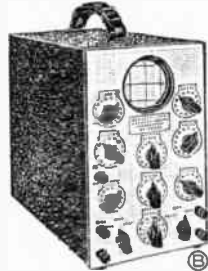

(C)



(G)



(H)



(J)



(K)



(D)

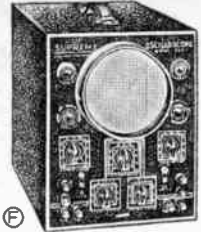

(F)

Electronic Development Laboratory 5-Inch Oscilloscope—Model 49

(D) Amplifiers compensated to give high frequency sine and square wave response, wide range linear sweep and freedom from hum effects. Horizontal and vertical sensitivity .5 RMS volt s/inch through amplifier and 14.5 RMS volts/inch direct. Horizontal and vertical amplifier input impedance .5 megohm in parallel with 20 mmf. Terminals at rear of instrument provide low capacitance connections direct to deflecting plates. For 105-120 volts, 50-60 cycles. 8 1/2x14 1/2x18 1/2". Shpg. wt. 44 lbs.

\$113.00
C21595—Your Cost.....

DUMONT 5-Inch Model 274

(E) Amplified Sweep Circuit over continuous range from 20 to 50,000 cycles. Input impedance: 11ohm horizontal, 5 megohms vertical; 1 megohm. Deflection sensitivity: Max. vertical 0.65 RMS volt/in.; horizontal 0.65 RMS volt/in. Input signal may be applied to the vertical plates either directly or through the vertical amplifier through a switch provided on the front panel. Internal modulation of the horizontal beam is provided for by a separate terminal. Horizontal amplifier may be switched to either sweep circuit or external signal. For 115 volts, 50/60 cycles. 14x8 1/2x19 1/2". Shpg. wt. 35 lbs.

\$127.50
C21774—Your Cost.....

SUPREME Model 552 5-Inch Oscilloscope

(F) Sweep oscillator with frequency range of 20 to 30,000 cycles. Linear control for fine adjustment. Sync control for positive locking of pattern on screen. Vertical and horizontal amplifiers will pass 60 cycle square wave. Rated sensitivity at .3 volts RMS/inch deflection. Vertical amplifier 20 cycles to 100 KC; horizontal amplifier 20 cycles to 75 KC. Switches arranged for external sync and horizontal sweep. Heavy steel case. Gray wrinkle case. 12x9 1/2x18". Shpg. wt. 32 lbs. with tubes.

\$97.51
C21591—Your Cost.....

SUPREME Model 546-A

Same as Model 552 but 3" tube and voltage sensitivity .5 v. RMS. 13 1/8x11 1/2x7 1/8". Shpg. wt. 23 lbs. with tubes.

\$87.95
C21598—Your Cost.....

HICKOK Model 195 5-Inch Oscilloscope

(J) Sinusoidal sweep with phasing control. Wide range sweep circuit oscillator. Deflection sensitivity; Vertical—.05 volts RMS/inch, direct 15 volts RMS/inch. Horizontal—.15 volts RMS/inch, direct 20 volts RMS/inch. Vertical amplifier 30 cycles to 50 KC—Horizontal amplifier 10 cycles to 50 KC. Input impedance: vertical—1 meg., 25 mmf., Direct—2.2 meg. Horizontal—4 meg., 35 mmf., Direct—2.2 meg. Light shield and calibrated screen for accurate work in brightly lit rooms. 105-125 volts, 50-70 cycles. 8 1/2x18 1/2x13". Shpg. wt. 30 lbs. Complete with tubes.

\$132.00
C21594—Your Cost.....

HICKOK Model 505 5-Inch Oscilloscope

(K) Wide band vertical amplifier from 30 cycles to 1 MC. Horizontal amplifier 10 cycles to 50 KC. Deflection sensitivity .2 volts RMS/inch on vertical, .3 volts RMS/inch on horizontal, 45 volts RMS/inch on horizontal-direct. Input impedance is 1 megohm, 25 mmf. on both vertical and horizontal. Includes: built-in wide and narrow band FM oscillator, 3 range frequency compensated attenuator network, Demodulator which permits modulated signal to be viewed, Signal tracer jack which permits signal being viewed to be heard by phones. Self-contained mixer circuit for frequency modulated output with any good signal generator. Return eliminator speeds up FM and AM alignment. Modulation circuit permits FM oscillator to be either internally modulated or from an external source such as phonograph pick-up or microphones. Sinusoidal sweep with phasing control. Retractable light shield for use in brightly lit areas. Size: 14x11 1/2x15 1/2". Shpg. wt. 35 lbs. Complete with tubes.

\$165.60
C21451—Your Cost.....

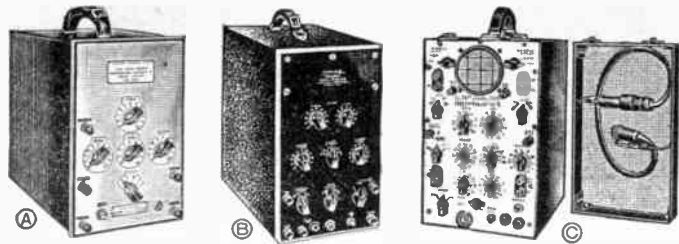

DUMONT Electronic Switch and Square Wave Generator

(A) Model 185A. Permits the simultaneous observation, for purposes of comparison, of two or more independent signals on the screen of a single cathode ray oscillograph. Square wave signals may be used in studies of vacuum tube amplifiers and other networks over a range of 10 to 500 c.p.s. Switching rate 10-2000 times per second. Input resistance 100,000 ohms. Output resistance 50,000 ohms. All controls and connections on front panel. For 115 V. 40-60 cycles. Complete with tubes. Black wrinkle finish steel cabinet. 11½x7½x13". Shpg. wt. 17 lbs.

C21783—Your Cost.....\$105.00

Type 215 Low-Frequency Linear Time Base Generator

(B) Sweep frequency range of .2 to 125 cycles per second. Balanced output signal voltage. Maximum undistorted output of approximately 400 volts peak to peak. Single sweep initiated either manually or by observed signal. Excellent linearity assured by compensating circuit. Return trace blanking. For 115 or 230 volts, 40-60 cycles. In black wrinkle finished steel case. 14¼x8¾x19½". Shpg. wt. 40 lbs.

C21556—Your Cost.....\$215.00

Type 224-A 3-Inch Oscillograph

(C) For study of signals such as pulse and square waves involving frequency components as high as 2 megacycles. Wide band vertical amplifier response within 3 db. to 2 megacycles. Provision for intensity modulation. Uses Type 3GP1 C.R. tube. For use on 115 volts, 50/60 cycles. In portable steel cabinet with carrying handle. Rugged instrument for field as well as laboratory use. Size: 14½x8¾x15½".

C21558—Your Cost.....\$290.00

FERRET Audio Oscillator

(F) Incorporates recently engineered developments. Uses four miniature tubes to achieve a range of 20 to 24,000 cycles. R/C type oscillator with sine or square wave on same calibrations with accuracy of 2% on all bands. Output is high impedance, 25 volts sine or square wave selected by a simple rotary switch. Output lead is coaxial cable. Three colored dial with 3 to 1 vernier glass enclosed for protection against damage and dirt encased in a molded escutcheon. Front panel of three color iridescent blue-gray finish. Housed in an attractive blue-gray Hammer-tone finish aluminum case with leather carrying handle. For use on 110-120 volts, 50/60 cycles. Size: 10¼x10¼x5½". Shpg. wt. 10 lbs.

C21431—Your Cost.....\$89.95

G-E Signal Generator—YGS-3

(G) Comprised of four units, any of which may be used independently or in any logical combination by switching front panel controls. Includes RF oscillator with fundamental frequency range of 100 KC to 150 MC; FM oscillator with center frequencies of 1, 20 and 50 MC and frequency deviations of 20, 300 and 750 KC respectively; 1 megacycle crystal calibrator; variable frequency audio oscillator. Internal mixer enables operator to obtain any desired FM frequency within the beat frequency range of the RF and FM oscillators. Both AM and FM oscillators may be modulated at any frequency within the range of the audio oscillator or by an external source. Percentage modulation or frequency deviation is continuously variable and is indicated by calibrated sections of a dual electron ray gun. RF level control in conjunction with step and line attenuators provides control of the output level with negligible frequency shift. Good stability, low distortion and essentially flat output throughout the entire frequency range of 100 to 12,000 cycles is provided by an RC type audio oscillator. A one megacycle low-drift crystal in the calibrator unit provides modulated or unmodulated harmonics to 150 MC. Separate audio and LF output cables are supplied. In copperplated fabricated steel case, outside gray wrinkle finish. Leather carrying handle. Removable cover with compartment for output cables. 17½x9¾x9½". 105-125 volts, 50/60 cycles. Shpg. wt. 35 lbs.

C21562—Your Cost.....\$225.00

INDUSTRIAL INSTRUMENTS • AUDIO • OSCILLATORS

RCA WV-75A Volttohyst

(D) Model WV-75A Volttohyst is an electronic voltmeter with full wave diode probe for reading peak-to-peak RF voltages to frequencies of 250 MC. Push-pull DC VTVM circuit is exceptionally stable and linear. Large electronically controlled burn-out proof DC meter with crystal clear anti-static coated one-piece unbreakable front.

Ranges: 0-3/10/30/100/300/1000 VDC; with diode probe 0-3/10/30/100 VAC. Frequency with diode probe 30 c.p.s. to 250 MC. diode probe and lead 30 c.p.s to 30 MC. and probe with AC multiplier 30 c.p.s. to 15 KC: DC resistance 0-1M/10M/100M ohms and 0-1/10/100 megohms. Input impedance using diode probe; 650M ohms and 15 mfd. at 1 MC. 32M ohms and 14.5 mfd. at 10 MC and 100 ohms and 13 mfd. at 250 MC Input impedance using diode probe with AC multiplier: 1.65 megohms and 2 mfd. at 1 KC and 1.65 megohms and 2 mfd. at 10 KC.

Steel case with grey wrinkle finish and etch brush chrome finish front panel. Complete with tubes, diode probe, test leads, and instructions. 105-115 volt 50-60 cycle operation. Shpg. wt. 18 lbs.

C21772—Your Cost.....\$125.00

RCA Audio Voltmeter

(E) Unusual sensitivity and wide range of .001 to 1000 volts AC. Excellent frequency response over the audio range (20 cycles to 20 KC). May be used as an AF amplifier with high gain and good fidelity. Unvarying meter readings despite line voltage changes or tube replacements. Logarithmic scale and overlapping attenuator provide accuracy even when pointer is at either end of scale. Can be connected across high DC potentials without harm. High level rectifier designed to produce an output proportional to the average value of the full wave, giving a meter reading that agrees very closely with an RMS meter for all usual distorted wave forms. Input impedance 1 megohm and 25 mfd. Attractive cabinet finished in dark cobalt gray Metalustre with front panel of scratch brushed aluminum. 13½x9¾x7¼". Shpg. wt. 18 lbs.

C21561—Your Cost.....\$175.00

SUPREME Audio Oscillator

(H) 15 to 15,000 cycles. Dial calibration spread over a 12-inch arc covering 280 degrees. Large 6-inch metal dial with laboratory type tuning knob. Output impedances of 250/500/5000 ohms. Each center-tapped for push-pull and other balanced input systems. Output continuously variable from minimum to maximum. Open circuit voltage approx. 65 RMS volts at 5000 ohms section. Properly loaded, produces 50 volts total or 25 volts either side of center tap. Sinusoidal type wave form with harmonic distortion at least 30 db below fundamental at 5000 cycles. Output virtually flat over the entire frequency range. Plus or minus 1 db from 30 cycles to 10,000 cycles. 2 db down at 15 and 15,000 cycles. All controls arranged for speed and simplicity of operation. Neon lamp for zero adjustment. Housed in grey wrinkle finish steel case. Steel panel finished in grey wrinkle, with white letters and markings, red highlights. Leather carrying handle. For 110/125 volts, 50/60 cycles. Size: 13¼x9x6½".

C21563—Your Cost.....\$61.69

SUPREME AF and RF Oscillator

(J) Designed to produce all the various signals required for test and repair of radio receivers. Two distinct and separate instruments—either of which may be operated independently—or together, FM oscillator for visual alignment of IF amplifiers in amplitude modulated receivers. Large three-inch round meter used to set amount of modulation. Variable from 1 to 80%. AF Oscillator flat to within 1 db from 30 to 10,000 cycles. 15 cycles and 15,000 cycles down approx. 2 db. Center tapped transformer with push-button selector of output impedances at 50/500/5000 ohms. High impedance resistor of 50,000 ohms. Attenuator controls voltage from 0 to open circuit voltage of 35 volts. RF Oscillator covers 65 KC to 20.5 MC in push-button selected five bands. Harmonics above 60 MC. Tuning knob geared to capacitor with a ratio of 5 to 1. Meter used to set carrier level at a predetermined value, aligned for accurate and variable per cent of modulation by AF oscillator. FM signal available over the range of the RF oscillator. Ladder type four-position resistor push-button attenuator. Vernier control from maximum to minimum on any of the four steps. For use on 110-125 volts, 50/60 cycles. Size: 15½x11¼x8¾". Shpg. wt. 33 lbs.

C21717—Your Cost.....\$133.87

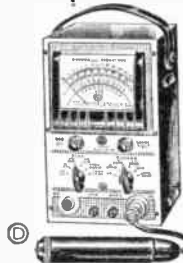

CAPACITOR CHECKERS • SIGNAL TRACERS

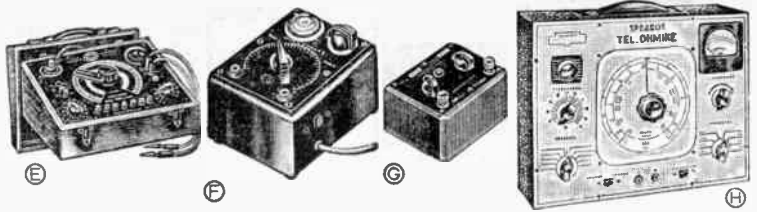

SOLAR Exam-Eter CF-1-60

(A) Accurate Wien bridge for capacitance and power factor measurements. May be switched to Wheatstone type bridge for resistance measurements. Capacitance from 10 mfd. to 2000 mfd. Insulation resistance from 3 to 10,000 megohms. and resistance of resistors from 100 ohms to 7.5 megohms. may be accurately checked. Uses 1-6L6, 2-6J5G. 110 volts a.c., 50-60 cycles. Size: 12 $\frac{3}{4}$ "x10 $\frac{1}{2}$ "x5 $\frac{1}{2}$ ". Shpg. wt. 13 lbs.
C21790—Your Cost \$58.50

SOLAR Capacitor Analyzers

(B) For measuring the capacity of any electrolytic, paper mica, or air condenser between the extremely wide limits of .00001 and 800 mfd. Electron ray bridge-balance indicator. Also measures power factor of electrolytics in percentage. Detects defective condensers. Checks resistance from 50 ohms to 2 megohms. Insulation resistance tests with tubes. For 115 volts, 60 cycles. Size: 9 $\frac{1}{2}$ "x7 $\frac{1}{2}$ "x6 $\frac{1}{2}$ ". Shpg. wt. 9 lbs.
C21781—Your Cost \$39.00

Model CBB-2-U. Same as above but for 110-220 volts, 25/60 cycles.
C21777—Your Cost \$45.96

SILVER Model 904 C-R Bridge

(C) Highly accurate, wide range, electronic bridge. Measures resistors and capacitors of all types. Has "eye" with variable sensitivity for accurate readings, power factor and insulation resistance tests, and variable applied test voltages of 0 to 500 volts DC. Four ranges each for resistance and capacitance: 10 ohms to 1000 megohms, 10 mfd to 1000 mfd for 115 volts, 50-60 cycle AC with tubes and test leads. Size: 15x11x9". Shpg. wt. 14 lbs.
C21541—Your Cost \$49.90

GE Model YCW-1 C-R Bridge

(D) Wein Bridge principle assures accurate measurements. Measures: Capacity from .000005 mfd. to 200 mfd. in three ranges. Electrolytic leakage, Insulation resistance from 0 to 2500 megohms. Resistance from 5 ohms to 20 megohms in two ranges, power factor and turns ratio of transformers. Voltmeter reads 0-500 DC. Push-button switching. Sensitive electron-ray tube for bridge-balance indication. Completely portable—weighs 10 lbs., 115 volt, 50 or 60 cycle. Size: 9 $\frac{3}{4}$ "x12"x7". Steel case, with cover.
C21597—Your Cost \$59.50

C-D "BF-50" Analyzer

(E) Incorporates a "Wien" bridge with single stage of amplification and visual "eye" for measurements. Built-in power supply for making leakage and insulation resistance tests. Measures paper, mica, air and electrolytic condensers, from .00001 to 240 mfd. Measures power factor, leakage, tests for shorts. Complete with tubes. In Walnut portable case, dimension: 6 $\frac{1}{2}$ "x12x9 $\frac{1}{4}$ ". Shpg. wt. 11 lbs.
C21727—Your Cost \$41.80

C-D "BN" Capacitor Bridge

(F) Measures accurately and quickly all capacitors between .00001 and 50 mfd. Employs Wien bridge circuit, with visual "eye" to indicate balanced conditions. Has direct reading scale, and employs 2 tubes, a 12A7 and 6AF6G. Indicates power factor, shorts, etc. In Walnut bakelite case, dimension: 3 $\frac{3}{4}$ "x5x3". With test leads and instructions, and tubes. For 110 V., 60 cycles. Shpg. wt. 4 lbs.
C21728—Each \$19.50

C-D Capacitor Decades

(G) Accurate standards covering a wide range of capacity in 3 units. For use with Type "BN" Capacity Bridge shown above or similar precise unit. Capacity range: .0001 to 11.1 mfd. Calibration chart with each. Rating 600 V. DC-220 V. AC; Tolerance $\pm 5\%$. Walnut Bakelite case, dimension: 3 $\frac{3}{4}$ "x5x3". Shpg. wt. 4 lbs.
C21729—.011 mfd. in .0001 steps \$8.33
C21730—.1 mfd. in .01 steps \$17.15
Your Cost, Each Above \$17.15

SPRAGUE TO-3 Tel-Ohmike

(H) Speedy check locates open, intermittent, or shorted condensers without removing them from the circuit. Dial of direct reading calibrated type, color coded to correspond to selector switch. Measures .00001 to 2,000 mfd. in 4 ranges, power factor from 0 to 50% at 60 cycles. 0 to 2,500 megohms insulation resistance, 2.5 ohms to 25 Megohms in 3 resistance ranges, and DC voltage in three ranges to 750 volts, DC ma. in three ranges to 75 ma. Capacity and power factor of electrolytic condensers measured with rated polarizing voltage applied. Electrolytic leakage measured in μA . at rated DC voltage. For 115 volts, 60 cycles. 13 $\frac{1}{4}$ "x10 $\frac{1}{2}$ "x5". Shpg. wt. 15 lbs.
C21717—Your Cost \$59.70

FEILER Signal Tracing Analyzer Model TS-3

(A) New electronic "stethoscope" that gets to the heart of radio troubles in a flash. Completely portable and AC operated. Uses biased diode detector probe. Does not upset the most critical circuits. 5" PM dynamic speaker included. Makes audible all signal—30 cps to 120 MC—RF, IF, Audio—without using special controls or tuning. Provision for output meter for silent tracing and for RF vacuum tube voltmeter for visual indications. In handsome brown iridescent finish. 115 v. 50/60 cycle. Size: 11 $\frac{1}{2}$ "x8x6". Shpg. wt. 22 lbs.
C21778—Your Cost \$34.95

Model TS-2

Same electrical characteristics and physical size as above but battery operated. Less batteries.
C21798—Your Cost \$29.95
 Burgess M30 batteries, 2 required. **\$1.65**
C20617—Your Cost Each \$1.65
 Burgess G3 batteries, 1 required. **51¢**
C20610—Your Cost Each \$1.65

Model TS-1

Rapid point to point testing. Portable metal case contains compartment for cable, probe and batteries. Handy sized probe contains tube and circuit components. Operates on one 22 $\frac{1}{2}$ -volt battery and one No. 2 flashlight cell. Requires set of magnetic headphones. With operating instructions. Size: 6 $\frac{1}{2}$ "x4 $\frac{1}{2}$ "x3 $\frac{3}{4}$ ". Shpg. wt. 6 lbs. Not illustrated.
C21797—Your Cost (Less batteries and phones) \$9.85
C19862—22 $\frac{1}{2}$ -volt Battery \$1.31
C20622—No. 2 Cell 61¢
C13892—2000 Ohm Headset \$1.40

PRECISION Signal Tracer

(B) Unit complete with high frequency probe and tubes, ready to operate on 110-120 volts A.C. 60 cycles covering A.M., F.M. and television sound. 30 cycles to well over 100 Megacycles with a separate channel for audio frequency. High frequency tube in probe with 3-tube High Gain Amplifier of 5 watts for RF-IF frequency makes all signals audible. Full control of the RF-IF stage is provided by a variable control and a resistive attenuator. Shpg. wt. 11 lbs.
C21799—Your Cost \$29.95

PRE-CHECK Midget Analyzer

(C) Makes fast accurate tests for open circuited condensers, ANY TYPE, in trouble shooting for low volume, excessive oscillation or distortion. Test for presence or lack of voltage on filament, plate or screen; open bleeder resistors and cathode resistors; continuity of any receiver circuit. Made of highly polished fibre tubing. All joints fitted and permanently sealed, then baked. Length overall 8 $\frac{1}{2}$ " x 3 $\frac{1}{2}$ " dia. Furnished with test lead, neon lamp and rubber insulated alligator clip. Shpg. wt. 1 lb.
C11305—Your Cost \$2.25

FERRET Deluxe Test Set

(D) Designed to eliminate the necessity of removing set speaker from radios, for servicing. Voice coil connections permit substitution of any output transformer. Input and field switches on front panel permit matching to any single or push-pull output tubes. Provides substitution for chokes, electrolytic condensers, coupling, by-pass condensers and a wide range of resistors. Eliminates soldering until all defective parts are located and substituted. A compact, portable lightweight unit 6" PM speaker. Attractive front panel with red and white lettering. Completely enclosed in black wrinkle aluminum case with leather handle. Size: 10 $\frac{1}{4}$ "x10 $\frac{1}{4}$ "x5 $\frac{1}{2}$ ". Shpg. wt. 7 lbs.
C21430—Your Cost \$29.95

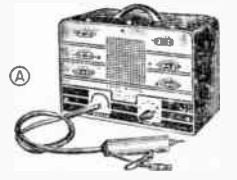

ALIGNING TOOLS and TEST PRODS

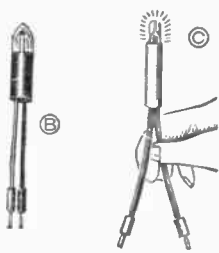
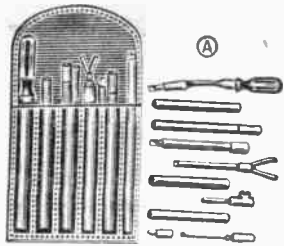

ICA Aligning Kit

(A) 14 tools telescope into six units: a flexible screwdriver, alignment tool, alligator side wrench, 6" insulated driver—metal nib, 5/16" and 3/4" nut wrench, 1/2" insulated square nut wrench, 1/4" hex metal side wrench, 2 1/2" insulated driver with metal nib, 1/4" hex slotted wrench driver, 5/16" hex insulated nut wrench, 5" and 6" insulated driver.

C15088—Kit Your Cost \$4.41

Like above, but less flexible screwdriver and aligning tool.

C15089—Your Cost \$2.75

Neon Electrical Tester

(B) Indicates from 60 to 500 V AC/DC. Traces shorted, open, or grounded circuits.

C12958—Your Cost \$29¢

Neon Circuit Tester

(C) Shows open circuits, polarity, continuity, etc. Checks fuses in circuits. Tiny neon lamp glows on only .1 ma. Coded leads have phone tips. 90-550 v. For AC or DC.

C11310—Each \$59¢

Low Voltage Type, Range 5 to 50 v. Leads have alligator clips. C11308—Each \$1.10

Hex. Socket Aligner

(D) 6" long with brass 1/4" socket head. Other end has screwdriver bit. Shaft dia. 7/16".

C15104—Your Cost \$41¢

ICA Aligning Tool Set

(E) Two tools, one fits within other. One is 6" long, 3/8" diameter with fitted brass wrenches for 1/4" and 3/8" hex nuts. Other is 3/8" rod fitted with screwdriver nib.

C15083—Your Cost \$73¢

AMPHENOL

U.H.F. Aligning Tool

(F) Pure Polystyrene—no capacity effect on critical circuits.

C15075—Each \$15¢

ICA Low "C" Aligner

(G) A low capacity screwdriver for aligning superhets. 1" bone fibre, with 2 driver nibs. One extends 1 1/2" for padding condensers. Other has recessed screwdriver for permeability tuned circuits.

C15145—Your Cost \$43¢

ICA 5-in-1 Aligner Kit

(H) Combines in a fountain pen size tool, 1/4" and 3/16" nut wrenches, miniature blade screwdriver for all aligning and a full-size insulated handle screwdriver, 3-piece set.

C15082—Your Cost \$79¢

FIBRITE Screwdriver

(J) 7" long; driver at both ends for all trimmer condensers.

C15150—3/16" diameter \$23c

C15151—5/16" diameter \$21c

Flexible Tuning Wand

(K) For determining correct alignment. A 6" flexible rod; one end brass loaded—the other, core steel. Placing either end in magnetic field of coil will show inductive condition.

C14978—Your Cost \$59¢

Solid Tuning Wand

Similar to above, except that the body is solid insulation.

C14976—Your Cost Ea. \$59¢

Neon Test-O-Lite

(L) Will check any voltage between 110 and 550 volts—either a.c. or d.c. Will also check spark-plugs, radio sets, appliances, etc. Distinguishes a.c. from d.c. Bakelite case with pocket clip.

C12983—Your Cost \$98¢

Neutralizing "Driver"

(M) For aligning coils, condensers, etc.

C15080—6 1/2" x 1/4". Each \$24¢

4-1 Neutralizing Tool

(N) Has pen clip for pocket. 1/2" nut wrench with key slot, and aligning screwdriver.

Bakelite. C14915—Your Cost \$50¢

Heavy Duty Test Prods and Leads

Pencil Prod Kit

(O) Spring prongs at the end of prods allow changing leads from spade lugs to phone tips or to spring clips. Handles are 6" long, 3/4" diameter. Five foot red and black kinkless wire. Complete with two alligator clips, two needle point phone tips and two tapered lugs.

C12971—Your Cost \$1.47

Similar to above, but fixed Spring Clip Ends.

C12882—Per Set \$73c

C12883—Per Set With Phone Tip Ends \$68c

ICA Test Lead Kit

(P) Leatherette pocket case. With one pair of test leads having 60" of red and black kinkless wire; one end has insulated phone tips, the other insulated removable banana plugs. Also includes one pair each: insulated alligator clips; insulated spade plugs; insulated needle points (all 1 red, 1 black).

C12861—Each \$2.06

Weston Type Test Leads

(R) 5" long handles of red and black phenolic. With kinkless rubber wire. Molded finger grip tips with set screws. 65" overall.

C12988—Your Cost \$1.03

Test Prods

(S) High grade insulated prods, available with three different types of tips. **Type A** is standard solderless phone tip with knurled collar; **Type B** has chuck and nut to hold plain phono needle; **Type C** has banana plug to fit standard banana jack. **Red or Black—specify color.**

SOLDERLESS PROD (A)

No. Length Each

C12881 5 1/2" 24c

C12884 6 3/4" 29c

PHONO NEEDLE TIP (B)

C12868 4 3/4" 24c

C12869 5 1/2" 26c

BANANA PLUG TIP (C)

C12912 2 1/4" 24c

C12910 3 5/8" 26c

Alligator Clip Test Leads

(T) Has 6" red and black handles and a removable phono needle chuck.

C12980—Your Cost \$88¢

10,000 Volt Test Leads

(V) Safety test up to 10,000 volts. A necessity and life saver for all cathode-ray tube work, X-ray repair jobs and transmitter work. Large diameter bakelite prods 6 inches long with guarded midgem phone-tip prods on one end and 2 inch phone tips on the other end. The conductors are heavy-duty, heavily insulated cables. 18 gauge stranded tinned copper for low voltage drop. Cables 50 inches long. One lead is red, the other black. Shpg. wt. 1 lb.

C12885—Per Pair \$2.35

ICA "No Break" Prods

(W) Of solid brass, nickeled and covered with shockless live rubber—1 red, 1 black; sharp pointed tips. Other end of .30" kinkless rubber wires have solderless insulated phone tips.

C12999—Pair \$68¢

C13000—Same as above with standard phone tips \$59¢

ICA Laboratory Prods

(X) Removable phono needle chucks. Extra-long slim black and red handles knurled at end for easy grip. Handles 6" long with 48" long heavy duty kinkless flexible rubber wire.

Each \$82¢

C12978—Spade Tips

C12979—Phone Tips

Needle and Solderless Tip Prods

(Y) Chucks and nuts hold plain phonograph needles (Type A). Fibre handles 4" long, 3/8" diam., in red and black, colored kinkless wire. Type B is solderless tip with long point. Leads 50" long.

NEEDLE TIP PRODS (A)

No. Wire Ends Pair

C12976—Phone Tips \$53¢

C12975—Spade Lugs \$65c

C12977—Alligator \$65c

SOLDERLESS TIP PLUGS (B)

C12968—Phone Tips \$53¢

C12969—Spade Lugs \$65c

C12970—Alligator \$65c

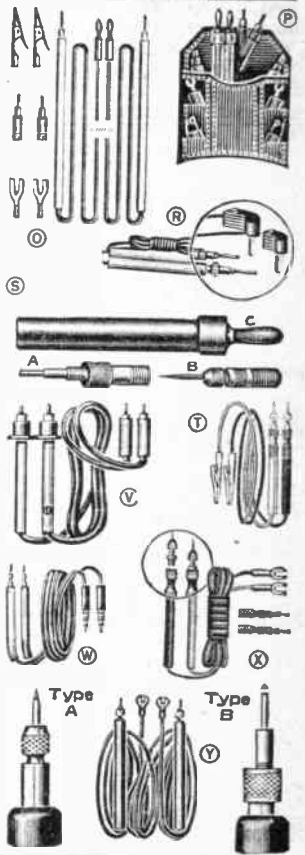

IMMEDIATE SHIPMENT FROM CHICAGO OR ATLANTA

TRIPLETT PANEL METERS

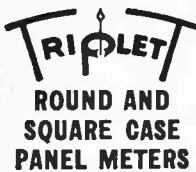
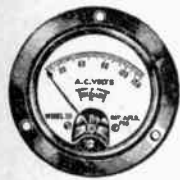

Incorporate precision engineering, the finest materials and workmanship. Molded cases, all terminals molded in. Sapphire jewels in adjustable screws. Accuracy within 2%.

D.C. Milliammeters—Round and Square Case

Range	2" Round 221		2" Square 227A		3" Round 321		3" Square 327A		4" Square 426	
	No.	No.	Each	No.	No.	Each	No.	No.	Each	Each
0-1	C11208	C11288	\$6.08	C11200	C11320	\$7.35	C11321	C11336	\$8.92	
0-1.5	C11209	C11289	6.08	C11201	C11321	7.35				
0-3	C11415	C11290	6.08	C11411	C11322	7.35				
0-5	C11416	C11298	5.10	C11412	C11323	6.08	C11337		7.64	
0-10	C11210	C11299	5.10	C11202	C11324	6.08	C11338		7.64	
0-15	C11211	C11300	5.10	C11203	C11325	6.08	C11339		7.64	
0-25	C11398	C11306	5.10	C11394	C11326	6.08	C11340		7.64	
0-50	C11212	C11309	5.10	C11204	C11327	6.08	C11341		7.64	
0-100	C11213	C11311	5.10	C11205	C11328	6.08	C11342		7.64	
0-150	C11417	C11312	5.10	C11413	C11329	6.08	C11343		7.64	
0-200	C11214	C11313	5.10	C11206	C11330	6.08	C11344		7.64	
0-250	C11418	C11314	5.10	C11414	C11331	6.08	C11345		7.64	
0-300	C11287	C11315	5.10	C11395	C11332	6.08	C11346		7.64	
0-500	C11215	C11316	5.10	C11207	C11333	6.08	C11347		7.64	
0-750	C11400	C11317	5.10	C11396	C11334	6.08	C11348		7.64	
0-1000	C11401	C11318	5.10	C11397	C11335	6.08	C11349		7.64	

D.C. Microammeters—Round and Square Case

Range	No.	Each	No.	Each	No.	Each	No.	Each
0-50*			C11352	\$17.05	C11354	\$17.05	C11358	\$22.74
0-100*			C11353	15.29	C11355	15.29	C11359	20.38
0-200	C11432	\$8.92	C11434	12.45	C11356	12.45	C11360	14.01
0-500	C11433	7.64	C11435	9.51	C11357	9.51	C11361	10.78

*With Cobalt Magnets

A.C. Voltmeters—Round and Square Case

Range	2" Round 231		2" Square 237A		3" Round 331		3" Square 337A		4" Square 436	
	No.	No.	Each	No.	No.	Each	No.	No.	Each	Each
0-5	C11280	C11449	\$5.10	C11273	C11459	\$6.08	C11466	\$7.64		
0-10	C11281	C11454	5.10	C11274	C11460	6.08	C11467	7.64		
0-15	C11282	C11455	5.10	C11275	C11461	6.08	C11468	7.64		
0-25	C11283	C11456	5.10	C11276	C11462	6.08	C11469	7.64		
0-50	C11284	C11380	5.10	C11277	C11381	6.08	C11382	7.64		
0-150	C11286	C11457	6.08	C11279	C11463	7.35	C11470	9.31		
0-300	C11409	C11458	7.45	C11406	C11464	8.43	C11383	10.29		
0-15-150				C11408	C11465	9.60				

D. C. Voltmeters

Model 321—1000 Ohms/Volt		
No.	Range	Each
C11240	0-10	\$8.43
C11241	0-50	
C11242	0-100	\$8.72
C11243	0-150	
C11244	0-500	11.07

D. C. Voltmeters

125 Ohms per Volt					
Model 321		Model 221			
No.	Each	Range	No.	Each	
C11230	\$6.08	0-5	C11247	\$5.10	
C11231		0-10	C11248		
C11232		0-15	C11249		
C11233	\$6.08	0-25	C11250	\$5.10	
C11234		0-50	C11251		
C11236		0-150	C11253		
C11237	\$7.35	0-250	C11254	\$6.17	
C11404	9.51	0-500	C11405	7.74	

Meter Dimensions

Model	Flange	Body Dia.
221, 231, 241	2 1/2"	2 1/2"
227A, 237A	2 3/8"	2 3/8"
321, 331, 341	3 1/2"	3 1/2"
327A, 337A, 347A	3 3/4"	3 3/4"
420, 430	4 1/4"	4 1/4"
521, 531	5 1/4"	5 1/4"
620, 630	6 1/2"	6 1/2"
720, 730	7 1/2"	7 1/2"



TRIPLETT D. C. Ammeters

These precision instruments incorporate the finest materials, and are assembled by skilled craftsmen. Molded cases; terminals molded

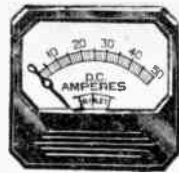

in. With external shunt. Prices on higher range meters, or on a.e. ammeters with current transformers, available on application.

Range Amps.	221-2" Round		321-3" Round		426-4" Square		626-6" Square	
	No.	Each	No.	Each	No.	Each	No.	Each
0-50	C10926	\$ 6.86	C10937	\$ 8.23	C10948	\$10.29	C10959	\$12.15
0-75	C10927	6.86	C10938	8.23	C10949	10.29	C10960	12.15
0-100	C10928	10.39	C10939	11.66	C10950	13.52	C10961	15.39
0-150	C10929	10.39	C10940	11.66	C10951	13.52	C10962	15.39
0-200	C10930	10.39	C10941	11.66	C10952	13.52	C10963	15.39
0-300	C10931	11.37	C10942	12.45	C10953	14.31	C10964	16.37

NOTE: These meters also available in ranges up to 1000 amps.

Power Level Indicators

For measuring noise levels in P.A., theaters, broadcast stations, etc. Range reads up 6 and down 10 db. Zero db at 1.73 volts, 500 ohm lines, 6 milliwatts. Standard damping. Wt. 3 lbs.



C11446 Model 321, 3" dia. **\$12.15**
Your Cost

C11447—Model 421, 4" sq. **\$20.38**
Your Cost

Thermo-Ammeters with Built-in Couples

For r.f. measurements, ant. radiation indications, etc.

Model 341 3" Round			Model 347A 3" Square		
No.	Each	Amps.	No.	Each	
C11229	\$7.06	0.5	C11220	\$7.06	
C11235	7.06	1.0	C11221	7.06	
C11238	7.06	1.5	C11222	7.06	
C11239	7.06	2.5	C11227	7.06	
C11246	7.06	5.0	C11228	7.06	

Thermo-Ammeters with External Couple

Model 341 3" Round			Model 241 2" Round		
No.	Cost	Amps.	No.	Each	
C11389	10.39	0.5	C11428		
C11391		1.0	C11425		
C11390		1.5	C11430	\$9.31	
C11392		2.5	C11426		
C11393		5.0	C11427		

Replacement couples on order, any range, specify. Each \$3.75

1000 Ohms-per-Volt Foundation Meters



0-1 d.c. milliammeter Foundation Instruments with internal resistance of 100 ohms (1000 ohms-per-volt). Scales read: 0-10-50-250-500-1000 volts; 0-1-10-50-250 milliamperes; low ohms, 2 to 500; high ohms to 100,000. Shpg. wt. each, 3 lbs.

Model	Each
C11442—Model 321, 3" Round	\$ 7.84
C11388—Model 326, 3" Square	7.84
C11278—Model 421, 4" Square	9.90
C11297—Model 521, 5" Round	10.98
C11285—Model 726, 7" Square	18.23

NOTE TRIPLETT equipment not listed on this page is available on special order at regular prices. Send for FREE TRIPLETT catalog and write us your requirements. Your correspondence will receive prompt and courteous attention.

LITTELFUSES For Test Instruments



Protect delicate instruments. Break circuit immediately on reaching blow point. Length 1" diam. 1/4". May be used on 250 volts, AC or DC. High Speed action. Type SAG

Stock No.	Rating Amps.	Max Load Ma.	Res. on 5 Ma. Load Ohms	Your Cost Each	Your Cost Per 100	V-M Ohms Per V.	To Protect Milliammeters
C12339	1/200	5	480	18c	\$14.70	over 1000	Galv.
C12385	1/100	10	160	12c	\$9.80	1000	up to 0-1
C12336	1/25	25	40			500-1000	1-10
C12387	1/60	60	5	9c	\$7.35	100 500	10-25
C12388	1/30	100	2			20-100	25-75
C12390	1/200	200	3.5			10-20	75-150
C12391	1/300	300	3			5 10	150-250
C12392	1/400	400	2			3-5	250-350
C12393	1/600	600	2		350 500		
C12394	1	1000	.24	6c	\$4.90		500-750
C12395	2	2000	.10				1000-1500

Reliance Meter Cases

Blac. crackle finish steel cases 4x1x1/4" high. Two ceramic insulators. 2 lbs. C10398—2 3/8" hole C10399—2 1/8" hole Your Cost **\$1.09**



"Meter Back" Fuse Mount

Mounts directly on any meter terminal. Will not touch other posts. Takes 1x1/4" instrument fuses only. C11049—Your Cost, **12c** Each

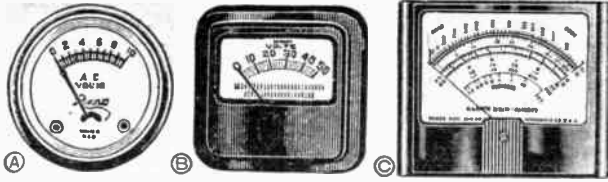

SHURITE METERS

Model 550, round, with clamp (A). Model 950, square, flange mounted (B). Black enamel finish. Both require $2\frac{1}{4}$ " hole. DC polarized-vane solenoid type; AC double-vane repulsion type. Accuracy within 5%.

D.C. MILLIAMMETERS			
Model 550		Model 950	
No.	Each	Range	No. Each
C11099	\$1.96	0-3	C11162 \$2.11
C11050	1.81	0-5	C11150 1.96
C11000	1.71	0-10	C11151 1.86
C11101	1.32	0-15	C11152 1.47
C11102	1.27	0-25	C11153 1.42
C11103	1.27	0-50	C11154 1.42
C11104	1.27	0-100	C11155 1.42
C11105	1.27	0-150	C11156 1.42
C11106	1.27	0-200	C11157 1.42
C11107	1.27	0-300	C11158 1.42
C11108	1.22	0-400	C11159 1.37

D.C. AMMETERS			
No.	Each	Range	No. Each
C11091	\$1.27	0-1	C11162 \$1.42
C11092	1.27	0-3	C11163 1.42
C11093	1.27	0-5	C11164 1.42
C11094	1.27	0-10	C11165 1.42
C11096	1.27	3-0-3	C11167 1.42
C11097	1.27	6-0-6	C11168 1.42
C11098	1.27	10-0-10	C11169 1.42
C11099	1.37	20-0-20	C11170 1.52

A.C. MILLIAMMETERS			
No.	Each	Range	No. Each
C11087	\$2.30	0-50	C11000 \$2.45
C11088	2.30	0-100	C11001 2.45
C11089	2.30	0-250	C11002 2.45
C11090	2.30	0-500	C11003 2.45

A.C. AMMETERS			
No.	Each	Range	No. Each
C11081	\$2.30	0-1	C11004 \$2.45
C11082	2.30	0-3	C11005 2.45
C11083	2.30	0-5	C11006 2.45
C11084	2.30	0-10	C11007 2.45
C11085	2.94	0-50	C11008 3.09

D.C. VOLTMETERS			
Model 550		Model 950	
No.	Each	Range	No. Each
C11051	\$1.22	0-1	C11009 \$1.37
C11052	1.27	0-3	C11010 1.42
C11053	1.27	0-5	C11011 1.42
C11054	1.27	0-6	C11012 1.42
C11055	1.27	0-8	C11013 1.42
C11056	1.32	0-10	C11014 1.47
C11057	1.37	0-15	C11015 1.52
C11059	1.27	0-25	C11016 1.42
C11060	2.35	0-25*	C11017 2.50
C11062	2.74	0-50*	C11019 2.89
C11063	1.47	0-100	C11020 1.62
C11064	2.94	0-100*	C11022 3.09
C11065	1.65	0-150	C11023 1.81
C11066	2.94	0-150*	C11024 3.09
C11067	3.18	0-300	C11025 3.33
C11068	3.67	0-500	C11026 3.82
C11070	1.27	3-0-3	C11042 1.42

A.C. VOLTMETERS			
No.	Each	Range	No. Each
C11073	\$2.30	0-6	C11029 \$2.47
C11074	2.30	0-10	C11030 2.47
C11075	2.30	0-15	C11031 2.25
C11076	3.43	0-150	C11032 3.58
C11077	4.07	0-300	C11033 4.21
C11079	5.05	0-750	C11034 5.19

RESISTANCE METER			
Direct reading 10,000 ohms, 4.5 volts.			
No.	Each	Range	No. Each
C11078	\$1.76	C11071	\$1.91

Flange for Round Meters
Diameter $2\frac{1}{4}$ " Black Finish.
C11041..... Each 13c

Shurite AND Marion METERS

CONANT

Instrument Rectifiers

General replacement rectifiers for all types of meters and relays.

Type E for applications requiring more than one milliamper current output. Disc diameter .50 inch.

Type F for applications requiring good frequency response and less than one mil. current output.

Type G. Same characteristics as Type F but outside case small enough to fit standard midget fuse clip. Ratings shown are continuous peak ratings. Intermittent ratings are twice figures shown. Instantaneous ratings are three times the figures shown.

Stock No.	Diag.	Fig.	Volts	M.A.	Your Cost
C10569	1	E	10	30	\$2.06
C10550	2	E	5	30	1.59
C10551	3	E	10	30	1.59
C10552	4	E	5	30	.88
C10572	1	F	10	5	2.06
C10553	2	F	5	5	1.59
C10554	3	F	10	5	1.59
C10555	4	F	5	5	.88
C10556	1	G	10	5	2.06

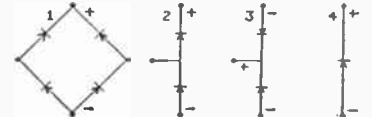
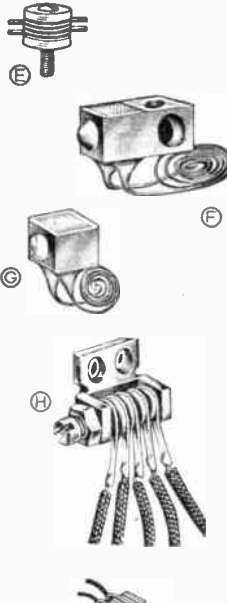

MARION Multi-Ranger Meters

Foundation meter is designed to permit the user to assemble a highly accurate Volt-Ohm-Milliammeter. Have full 100 degree three-color scales. Uses the new Alnico magnet. Scale readings are AC-DC Volts 0-10, 0-50, 0-250, 0-1000 Volts. Milliamps 0-1, 0-10, 0-50, 0-500 Milliamps. Ohms 0-500, 0-100M, 0-1Meg, 0-10 Meg. Decibels -10 to 54. Available in three electrically interchangeable sizes.

Stock No.	Model	Size	Your Cost
C10720	53SN	3" Square	\$7.84
C10721	55	4 5/8" x 4 3/8"	9.80
C10722	57S	7" x 8 1/2"	13.06

Shunt and Resistor Kit

Kit for Marion Multi-Ranger foundation meter. Consists of 14 metalized carbon film resistors and 4 Manganin wire wound shunts. Complete with schematic diagrams.

C10719. Your Cost **\$8.16**

MARION Hermetically Sealed Meters

These precision meters will withstand extremes in temperature without affecting the calibration. Heavy steel case affords magnetic and electrostatic shielding for use with hi-freq. equipment. Protected permanently against dirt, dust and moisture.

Guaranteed! If seal has not been broken, meters will be replaced FREE within 6 months from date of purchase; after 6 months, provided seal has not been broken, meters will be replaced at a charge of \$1.50 to \$2.50, depending on sensitivity. Guarantee applies regardless of electrical use or misuse of meter.

D.C. MILLIAMMETERS				
Stock No.	Range	Your Cost	Stock No. Range	
C10723	0-1	\$7.67	C10728	0-100
C10724	0-5	\$7.18	C10729	0-200
C10725	0-10		C10730	0-300
C10726	0-25		C10731	0-500
C10727	0-50			

D.C. MICROAMMETER				
Stock No.	Range	Your Cost	Stock No. Range	
C10732	0-50	\$14.70	C10734	0-200
C10733	0-100	11.44	C10735	0-500

D.C. AMMETERS				
Stock No.	Range	Your Cost	Stock No. Range	
C10736	0-10	\$7.18	C10738	0-25
C10737	0-15	7.18		

D.C. VOLTMETER (1000 ohms per volt)				
Stock No.	Range	Your Cost	Stock No. Range	
C10739	0-10	\$8.82	C10741	0-150
C10740	0-50	9.14	C10742	0-500

A.C. VOLTMETER				
Stock No.	Range	Your Cost	Stock No. Range	
C10743	0-15	\$10.29	C10745	0-150
C10744	0-50	10.61	C10746	0-250

Interchangeable round and square flanges for above meters.
C10747—Square 3 1/2". Your Cost 44c
C10748—Round 3 1/2". Your Cost 44c

BRADLEY Universal Rectifier

New "Coprox" model CX2E4U copper oxide rectifier fills all circuit needs within the rectifier rating. Circuit uses include:

Half wave.....	6 volts AC 3ma DC
	12 volts AC 3ma DC
	12 volts AC 5ma DC
Double half wave	6 volts AC 3ma DC
	6 volts AC 5ma DC
	12 volts AC 5ma DC
Full wave.....	6 volts AC 3ma DC
	12 volts AC 5ma DC
Full wave bridge	6 volts AC 5ma DC

C10565—
Your Cost **\$2.06**

ELECTROX Rectifier Units

Full wave copper oxide rectifier in metal housing with four insulated 3-inch leads. Continuous output of 5ma at max. of 3 volts DC. Max. input 4 volts AC.
C10566—Your Cost **\$2.59**

Full wave copper oxide rectifier in bakelite housing with five insulated 3-inch leads. Continuous output of 20ma at max. of 3 volts DC. Max. input 4 volts AC.
C10567—Your Cost **\$1.95**

Full wave copper oxide rectifier with five insulated 3-inch leads. Continuous output of 61ma at a max. of 3 volts DC. Max. input 4.1 volts AC.
C10568—Your Cost **\$1.75**

BRUJAC Meter Rectifier

Replacement for meter circuits varying from 50 microamps up to 15 milliamps. Will stand surges up to 5 milliamps. Size 1/4 x 3/8".
C10570—Your Cost **\$2.95**

RCA Testpoint Adaptor Set

Permits point to point and stage by stage testing of receivers and amplifiers above the chassis, without removing from the cabinet. Voltage tests and signal tracing accomplished at the tube base after inserting in the adaptor and replaced in the tube socket. Complete set consists of one each of 4, 5, 6, and 7 prong small, 7 prong large, octal and loktal types mounted on attractive wooden base. Shpg. wt. 2 lbs.
C21773—Your Cost **\$7.50**

SPRAGUE CONDENSERS

SPRAGUE "ATOMS" Ultra-Compact

Dry Electrolytics

Ultra-compact capacitors sealed in tubes with outer insulating sleeve. Protected against "Blow-ups." All have 3/16" bare wire leads riveted to end caps.

No.	Mfd.	Wkg. V.	D.-L.	Each
C769	10	25	3/16x1 1/8	44c
C770	25	25	3/16x1 1/8	50c
C2680	5	50	3/16x1 1/8	44c
C2682	10	50	3/16x1 1/8	47c
C771	25	50	3/16x1 1/8	53c
C2841	50	50	3/16x1 1/8	62c
C772	4	150	3/16x1 1/8	44c
C773	8	150	3/16x1 1/8	47c
C774	12	150	3/16x1 1/8	50c
C775	16	150	3/16x1 1/8	53c
C776	20	150	3/16x1 1/8	56c
C2840	30	150	3/16x1 1/8	59c
C777	40	150	3/16x1 1/8	65c
C778	4	450	3/16x2 1/8	53c
C779	8	450	3/16x2 1/8	56c
C780	12	450	3/16x2 1/8	68c
C781	16	450	3/16x2 1/8	79c
C782	20	450	3/16x2 1/8	88c
C783	10-10†	50	3/16x2 1/8	68c
C3164	8-8*	150	3/16x2 1/8	68c
C2842	12-20*	150	3/16x2 1/8	73c
C3165	20-20*	150	3/16x2 1/8	76c

Type "EL" Prong-Base Dry Electrolytics



In uninsulated metal cans with self-mounting feature; metal ears bend back under chassis. Lug terminals are coded. All are perfectly sealed and are impervious to moisture. Bakelite and metal mtg. plates listed below at right.

No.	Mfd.	Wkg. Vlt.	D.-L.	Each
C2522	10	450	1 x2"	\$0.76
C2523	15	450	1 x2"	.91
C2524	20	450	1 x2"	1.03
C2525	40	450	1 x2"	1.32
C2526	10-10	450	1 x2"	1.23
C2527	20-20	450	1 x2"	1.56
C2528	40-40	450	1 3/8x2"	2.35
C2529	20-20	250	1 x2"	1.21
C2531	20-20	150	1 x2"	.91
C2532	30-50	150	1 x3"	1.15
C2533	40-20	150	1 x2"	1.03
C2540	50-50	150	1 x3"	1.23
C2541	10-10/20	450/25	1 x3"	1.38
C2548	20-20/20	400/25	1 x3"	1.65
C2550	10-10/20	350/25	1 x2"	1.35
C2552	20-20/20	150	1 x2"	1.35
C2556	40-20/20	150	1x2 1/2"	1.41
C2593	40-40-40	150	1 x3"	1.53
C2597	10-10-10/20	450/25	1 3/8x2"	1.79
C2599	20-10-5/10	350/25	1 3/8x2"	1.79
C2602	40-20-10/20	200/25	1 3/8x3"	1.85

Cased Paper Condensers

Oil impregnated and wax filled. Fully cased and sealed to prevent melting of wax.



400 VOLTS WORKING				
No.	Mfd.	Dimen.	Each	
C2779	1	2 3/4x1 1/2x 3/8	\$0.68	
C2780	2	2 3/4x1 1/2x 1/2	1.06	
600 VOLTS WORKING				
C2781	1	2 3/4x1 1/2x 1/2	\$0.82	
C2782	2	3 1/4x1 1/2x 1/2	1.23	
1000 VOLTS WORKING				
C2783	1	4 1/2x1 1/2x 1/2	\$1.35	
C2784	2	4 1/2x2 1/2x 1/2	2.23	



No.	Mfd.	Wkg. V.	D.-L.	Each
C2683	20-20†	150	1 x2 1/8"	\$1.18
C744	20-30*	150	1 1/2x2 1/8"	.82
C797	30-30*	150	1 1/2x2 1/8"	.88
C745	20-40*	150	1 1/2x2 1/8"	.88
C746	40-30*	150	1x2 1/8"	.94
C798	40-10*	150	1x2 1/8"	1.00
C799	30-30*	150	1x2 1/8"	1.00
C747	50-50†	150	1 3/8x3 1/8"	1.09
C2843	40-20†	150	1 1/2x2 1/8"	1.38
C784	12-12*	300	1 1/2x2 1/8"	.76
C785	8-16*	200	1 1/2x2 1/8"	.76
C2844	8-16*	250	1x2 1/8"	.94
C2845	40-30†	250	1x2 1/8"	1.32
C787	16-16*	200	1 1/2x2 1/8"	.88
C2846	16-16*	250	1x2 1/8"	1.00
C2684	16-16†	250	1x2 1/8"	1.50
C786	8-8*	450	1 1/2x2 1/8"	1.09
C2685	8-8†	450	1 1/2x2 1/8"	1.23
C2847	8-16*	450	1x2 1/8"	1.18

(* 3 leads. (†) 4 leads.

Photo Flash Brochure

Sprague's complete Brochure on Photoflash, Principles, How to Build Flash Unit, How to Use.

C19997—Your Cost..... 25¢

Write for Sprague Tel-U-How Wall Chart.

C19999—FREE.

"LM" Cardboard Tube Compact Dry Electrolytics

All provided with universal mtg. lugs that can be soldered on top of chassis, anchored with screws or extended through holes in chassis and bent under. All have separate negative and positive leads. Lead ends are well sealed with high melting point compound; units are moisture proof.



Stock No.	Mfd.	Wkg. Vlt.	Size D.-L.	Your Cost
C2662	20	150	3/4x2 1/2"	\$0.68
C2663	8	450	3/4x2 1/2"	.68
C2664	16	450	3/4x2 1/2"	.91
C2665	20-20	150	1x2 1/2"	1.29
C2666	8-8	250	1x2 1/2"	1.29
C2667	16-16	250	1 3/8x2 1/2"	1.62
C2668	8-8	450	1x3	1.35
C2669	8-16	450	1 3/8x3 1/2"	1.59
C2670	16-16	450	1 3/8x4 1/2"	1.88
C2671	40-20/25	250/25	1 3/8x3 1/2"	1.97

Type AP Hi-Voltage Can



Dry Electrolytic for public address and theater applications where working voltage is high and surge voltage runs over 600.

Stock No.	Mfd.	DCW	Surge	Dim. D L	Your Cost
C2776	4	600	800	1 4/16"	\$1.76
C2777	8	600	800	1 3/4x1 1/2"	2.35
C2778	16	600	800	1 1/2x1 1/2"	2.94

Type PLS "Tiny Mike"

Dry electrolytic can type. May be mounted in any position. Standard through-chassis by threaded bushing on can which is completely insulated from the sections. Separate positive and negative leads. Extremely small size made possible by use of exclusive Sprague etched foil process.



450VoltsWorking 525 SurgeVolts

Stk. No.	Cap. Mfd.	No. of Leads	Dimen. Dia. Lg.	Your Cost
C2795	4	2	1 x2 3/8"	\$1.00
C2796	8	2	1 x3	1.03
C2797	12	2	1 x3	1.26
C2798	16	2	1 x3	1.41
C2786	20	2	1 3/8x2 1/8"	1.56
C2787	25	2	1 3/8x3 1/8"	1.68
C2788	30	2	1 3/8x3 1/8"	1.76
C2789	40	2	1 3/8x3 1/8"	2.00
C2790	4-8	4	1 3/8x2 1/8"	1.47
C2799	8-8	4	1 3/8x2 1/8"	1.62
C2791	8-16	4	1 3/8x4 1/8"	1.91
C2801	16-16	4	1 3/8x4 1/8"	2.06
C2800	8-8-8	6	1 3/8x2 1/8"	2.50

600 Peak Volt Replacement Dries

Highly formed dry electrolytics especially designed to replace wet electrolytics. Guaranteed to carry the ac ripple. Similar in appearance to PLS units.

Stock No.	Cap. Mfd.	Replaces Wet	Your Cost
C2515	8	4 to 8 mfd.	\$1.47
C2516	16	12 to 18 mfd.	2.20
C2517	25	20 to 40 mfd.	2.35

Photo-Flash Condensers

Light weight, hermetically sealed units with "Vitamin Q" impregnation. Designed for continuous rapid operation. 10,000 peak flashes guaranteed. 1800 peak flashes per hour maximum permissible. Adaptable to other uses where accurate time constants are required.

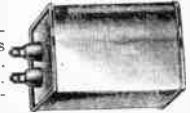

No.	Sprague	Mfd.	DC Peak V	Watt/sec	Size	Each
C3144	PQ 2510	10	2500	31	3 3/4x1 3/8x4 3/8	\$10.00
C3145	PQ 2515	15	2500	47	3 3/4x2 1/2x4 3/8	11.76
C3146	PQ 2525	25	2500	78	3 3/4x4 1/8x4 3/8	15.58
C3147	PQ 2535	35	2500	100	3 3/4x4 1/8x6	19.11
C3148	PQ 315	15	3000	67	3 3/4x4 1/8x4 3/8	14.41
C3149	PQ 425	25	4000	200	3 3/4x4 1/8x8 3/8	24.99

Type 68P Midget Tubulars

Extra Small Tubulars Designed for Miniature Radios



No.	Mfd.	Work. Volts	Dimen.	Each	No.	Mfd.	Work. Volts	Dimen.	Each
C2500	.001	400	3/4x1 1/16"	\$0.21	C2509	.005	200	3/4x1 1/16"	\$0.21
C2501	.002	400	3/4x1 1/16"	.21	C2510	.006	200	3/4x1 1/16"	.21
C2502	.003	400	3/4x1 1/16"	.21	C2511	.01	200	3/4x1 1/16"	.24
C2503	.004	400	3/4x1 1/16"	.21	C2512	.02	200	3/4x1 1/16"	.26
C2504	.005	400	3/4x1 1/16"	.21	C2513	.05	200	3/4x1 1/16"	.29
C2505	.006	400	3/4x1 1/16"	.21	C2514	.1	200	3/4x1 1/16"	.35
C2506	.01	400	3/4x1 1/16"	.24	C2520	.25	100	3/4x1 1/8"	.41
C2507	.02	400	3/4x1 1/16"	.26	C2521	.5	100	3/4x1 1/8"	.47
C2508	.05	400	3/4x1 1/16"	.29					

SPRAGUE Condenser Kits

Paper Tubular Kit of 10 type T C condensers. Contains three .05, two each .01, .02, 1 and one .25 all 600v. **\$2.28**

C2676—Your Cost. Paper Tubular Kit of 10 condensers. Contains four .01, three 0.2, two .05 and one .1. All 600v. **\$2.00**

C2677—Your Cost. Kit of 5 Atom electrolytics. Contains two 8mfd at 450v. one each 16, 20, 20/20 at 150v. **\$2.97**

C2678—Your Cost. Kit of 5 Atom electrolytics. Contains two 20/20, one 16mfd at 150v. one each 8, 20 at 450v. **\$3.49**

C2679—Your Cost.

"IF" Noise Filters

Small compact units for elimination of electrical noise. Types 1F 15 and 1F 21 for small motors. Type 1F 11 for 1 HP motors or larger. Type 1F S1 for thermostats, relays, door-bells, etc. Type 1F 37 for single fluorescent lamps. All rated 220 V AC-DC.



No.	Sprague	Sec.	Size	Each	No.	Sprague	Sec.	Size	Each
C12484	1F 15	3	1 x2 3/8"	\$1.12	C12488	1F S1	1	3/4x2 1/8"	\$0.68
C12486	1F 11	2	1 1/2x3 1/8"	2.59	C12489	1F 37	3	1 x2 1/8"	.88
C12487	1F 21	2	1 x2 3/8"	.91					

"BLUE BEAVER" Type BR Dry Electrolytics



Extremely small and very handy to use. Feature: **Electro-Chemical** etching that eliminates corrosion; **Hi-Formation Process** that affords higher voltage breakdown; **Hi-Pressure Centrifuge** that provides better impregnation and gives a lower power factor.

No.	Mfd.	Wkg.	Vlts.	In.	Each	No.	Mfd.	Wkg.	Vlts.	In.	Each
C1090	10	25	5x1 1/2		\$0.44	C1104	40	150	2x2		\$0.65
C1091	20	25	5x1 1/2		.47	C1105	4	250	5x1 1/2		.47
C1092	25	25	5x1 1/2		.50	C1106	8	250	5x1 1/2		.47
C1093	50	25	5x1 1/2		.56	C1107	12	250	5x2		.57
C1094	5	50	5x1 1/2		.44	C1108	16	250	5x1 1/2		.65
C1095	10	50	5x1 1/2		.47	C1109	20	250	5x2 1/2		.71
C1096	20	50	5x1 1/2		.50	C1110	40	250	5x2 1/2		.82
C1097	25	50	5x1 1/2		.53	C1111	4	450	5x1 1/2		.53
C1098	50	50	5x1 1/2		.62	C1112	8	450	5x2		.56
C1099	4	150	5x1 1/2		.44	C1113	12	450	5x2		.68
C1100	8	150	5x1 1/2		.47	C1114	16	450	5x2 1/2		.79
C1101	12	150	5x1 1/2		.50	C1115	20	450	1 x2 1/2		.88
C1102	16	150	5x1 1/2		.53	C1055	30	450	1 x3		.97
C1103	20	150	5x1 1/2		.56	C1116	8	500	5x1 1/2		1.18
C1054	30	150	3x2		.71	C1117	16	500	1 x2 1/2		1.18

"BRL" Dual Beavers (Com. Neg.)



Dual "Beavers" with common negative. Provided with sturdy center mounting strap; only one screw mounts to chassis. With long color-coded leads.

No.	Mfd.	Wkg.	Vlts.	In.	Each	No.	Mfd.	Wkg.	Vlts.	In.	Each
C1118	5-5	25	5x1 1/2		\$0.56	C1124	20-20	150	1/2x2 1/2		\$0.76
C1119	10-10	25	5x1 1/2		.62	C1125	8-16	250	3/8x2 3/4		.94
C1120	5-5	50	5x1 1/2		.65	C1126	16-16	250	1 x2 3/4		1.00
C1121	10-10	50	5x1 1/2		.68	C1127	8-8	450	1 x2 3/4		1.00
C1122	8-8	150	5x1 1/2		.68	C1128	8-16	450	1 1/2x3 1/4		1.18
C1123	8-16	150	1 1/2x2 1/2		.71						

"UP" Dry Electrolytics



Smallest can type dry electrolytics. Hermetically sealed in aluminum cans with terminal lugs on bakelite insulating cover. Can negative. Projecting tongues for vertical mounting on chassis or bakelite mounting plate. Tongues have wire holes. Feature low leakage and power factor, dependable operation over wide temperature range.

No.	Mfd.	Vlts.	In.	Each
C1150	10	450	1x2	1.03
C1151	20	450	1x2	0.76
C1152	40	450	1x3	1.32
C1153	20-20	150	1x2	.91
C1154	30-30	150	1x2	1.03
C1149	50-50	150	1x3	1.23
C1155	20-20	250	1x2	1.21
C1156	10-10	450	1x2	1.23
C1160	50-50/20	150/25	1x3	1.50
C1169	10-10/20	450-350/25	1x2	1.35

C1170—Bakelite mounting plate for 1" cans. Each.....3c

CORNELL DUBILIER CONDENSERS

"TVC" Metal Tubular Capacitors



Compact tubular metal can type units designed to withstand severe climatic conditions. Noninductively wound, impregnated and filled with Dykanol "B" to maintain high insulation resistance.

1000 Volts D.C.

Stock No.	MFD	Size	Each
C1175	.005	1 1/2x1 1/2	\$0.65
C1176	.01	1 1/2x1 1/2	.65
C1177	.015	1 1/2x1 1/2	.71
C1178	.02	1 1/2x1 1/2	.71
C1179	.03	5/8x2 1/2	.71
C1180	.05	5/8x2 1/2	.76
C1181	.05	5/8x2 1/2	.76
C1182	.1	3/4x2 1/2	.88

1600 Volts D.C.

C1183	.005	1 1/2x1 1/2	.71
C1184	.01	1 1/2x1 1/2	.71
C1185	.015	5/8x1 1/2	.73
C1186	.02	5/8x2 1/2	.76
C1187	.03	5/8x2 1/2	.76
C1188	.04	5/8x2 1/2	.76
C1189	.05	5/8x2 1/2	.82

"DT" Paper Tubulars

Halowax impregnated, multi-laminated Kraft tissues, Wax impregnated tube, wax-potted ends, oil-cooled Conservative DC rating.



No.	Mfd.	Each	No.	Mfd.	Each
C1221	.01	15c	C1228	.06	21c
C1222	.015	15c	C1229	.1	21c
C1223	.02	15c	C1230	.2	24c
C1224	.025	15c	C1231	.25	26c
C1225	.03	15c	C1232	.5	35c
C1226	.04	15c	C1233	1.0	53c
C1227	.05	18c			

600 Volts D.C. Wkg.

C1234	.0001	15c	C1247	.02	18c
C1235	.00025	15c	C1248	.03	21c
C1237	.001	15c	C1250	.04	21c
C1238	.002	15c	C1251	.05	24c
C1240	.004	15c	C1252	.06	24c
C1241	.005	15c	C1253	.1	26c
C1242	.006	15c	C1255	.25	32c
C1245	.01	18c	C1257	.5	47c

1600 Volts D.C.

Oil impregnated units especially designed for auto radio use.

C1262	.005	32c	C1269	.03	35c
C1264	.007	32c	C1270	.04	38c
C1266	.01	35c	C1271	.05	41c
C1268	.02	35c			

"BRH" High Capacity Low Voltage Units

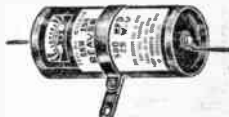

Etched foil electrolytic capacitors that are widely employed in portable radio power rectifying circuits, electric fence devices, etc. In drawn aluminum cans with cardboard sleeves. Center mounting strap.

No.	Mfd	Vlts	Size	Each
C2567	100	6	5/8x1 1/2	\$0.68
C2568	500	6	5/8x2 1/2	1.00
C2569	1000	6	5/8x2 1/2	1.32
C2573	1500	6	5/8x2 1/2	1.76
C2574	2000	6	1x2 1/2	2.29
C2575	100	12	5/8x1 1/2	.91
C2577	500	12	5/8x2 1/2	1.12
C2578	100	15	5/8x1 1/2	1.00
C2579	100	25	5/8x2 1/2	.71
C2553	500	25	1x2 1/2	1.32
C2554	100	50	5/8x2 1/2	.88

"DA" Metal Cased Paper By-Pass Condensers



Non-inductively wound. Wax impregnated and oil cooled. Lug terminals.

400 Volts D.C. Wkg.

No.	Mfd.	L x W x T	Each
C1277	.1	1 1/2x1 x 3/8"	\$1.03
C1278	.25	1 1/2x1 x 3/8"	1.18
C1279	.5	1 1/2x1 x 3/8"	1.26
C1342	1.0	2 x 1 1/2x1 1/2	1.53
C1343	2.0	2 x 2 x 1 1/2	1.97
C1344	1-1	1 1/2x1 x 3/8"	1.62
C1345	25-25	2 x 1 1/2x1 1/2	1.76
C1346	.5-5	2 x 1 1/2x1 1/2	2.06

600 Volts D.C. Wkg.

C1348	.5	2 x 1 1/2x1 1/2	\$1.62
C1350	1.0	2 x 2 x 1 1/2	1.85

C-D Molded Micacs



Compact mica condensers in molded bakelite housings. With wire leads. Individually tested; will give dependable service. Type 1W (fig. A) is 1 1/2x1 1/2. All are 1000 volts test, 500 volts DC working except sizes higher than .006 mfd. which are 600 volts test, 300 volts DC working.

No.	Mfd.	Fig.	Each
C1355	.00001	B	15c
C1356	.00002	B	15c
C1357	.000025	B	15c
C1358	.00005	B	12c
C1359	.0001	B	12c
C1360	.00015	B	12c
C1361	.0002	B	12c
C1362	.00025	B	15c
C1363	.0005	B	15c
C1364	.001	A	18c
C1366	.002	A	24c
C1367	.003	A	29c
C1372	.004	A	32c
C1373	.005	A	35c
C1374	.006	A	44c
C1377	.01	A	71c

C-D "Silver Mikes"



Designed for use in electronic circuits where frequency stability must be maintained. Molded in low-loss red bakelite and provided with tinned brass wire leads. All units rated 500 volts d.c. working, 1000 volts d.c. test except which are rated at 300 V. d.c. wkg., 600 volts d.c. test.

No.	Mfd.	Each	No.	Mfd.	Each
C1351	.000005	26c	C1386	.00015	26c
C1352	.00001	24c	C1387	.0002	26c
C1353	.000025	24c	C1388	.00025	26c
C1371	.0004	24c	C1389	.0003	32c
C1383	.0005	24c	C1390	.0004	38c
C1384	.0007	24c	C1391	.0005	41c
C1385	.0001	24c			
Type A—1 1/2x1 1/2 Square					
C1392	.001	\$0.65	C1396	.003	\$1.21
C1393	.0015	.79	C1397	.004	1.26
C1394	.002	.79	C1398	.005	1.32
C1395	.0025	1.06			

"KR" Dry Electrolytics



Extremely compact etched foil dry electrolytics with color coded leads. May be mounted in any position—either above or below sub-panel. Seamless drawn metal can equipped with mounting nut. Furnished with long insulated, color coded leads. Dual units have separate sections. Mounting nut supplied.

450 Volts DC Working

Stock No.	Cap. Mfd.	Size	Your Cost
C1295	4	1 x 2 1/2	\$1.00
C1296	8	1 x 2 1/2	1.03
C1297	12	1 x 2 1/2	1.26
C1298	16	1 x 3 1/2	1.41
C1299	4-8	1 1/2x3	1.47
C1300	8-8	1 1/2x3	1.62
C1354	8-16	1 1/2x4 1/2	1.91
C1302	8-8-8	1 1/2x4 1/2	2.50

600 Volts D.C. Working

Stock No.	Cap. Mfd.	Size	Your Cost
C1050	8	1 1/2x4 1/2	\$2.35
C1051	16	1 1/2x4 1/2	2.94

Type "WR" Dry to Replace Wet Electrolytics



Dry electrolytic capacitors in round aluminum cans especially designed to replace wet electrolytic units. Can is negative, lug terminal. Rated at 450 W. V. in four universal types. The 10 mfd. dry units will replace wet electrolytics from 4 to 12 mfd., 20 to 30 mfd., 40 mfd., 30 to 40 mfd. 1/4" mounting stud with palnut.

No.	Mfd.	Size	Each
C1052	10	1 1/2x2 1/2	\$0.85
C1053	20	1 1/2x2 1/2	1.32
C1057	30	1 1/2x3 1/2	1.53
C1056	40	1 1/2x3 1/2	1.71

"EZ" Universal Mtg. Dry Electrolytics



Popular low cost replacements. Have feet to replace inverted can or spade lug types or can be used beneath chassis by means of the center strap. Unused mountings can easily be cut off. Sealed in moisture-proof cardboard tubes, with 8" leads.

No.	Mfd.	Vlts.	Size	Each
C1326	16			

MALLORY CONDENSERS

TC Dry Electrolytics



Small dependable hermetically sealed aluminum case type condensers. Supplied with leads and insulating tube. Ideal for under chassis mounting. Can be used under all climatic conditions. Average diameter one inch.

Single Section—Type TC.

Stock No.	Cap. Mfd.	Wkg. Volts	Your Cost
C829	1000	3	\$1.06
C830	500	6	1.00
C831	1000	6	1.32
C832	500	15	1.23
C848	10	25	.44
C875	25	25	.50
C876	50	25	.57
C833	100	25	.71
C987	10	50	.47
C897	25	50	.53
C898	50	50	.62
C834	5	150	.44
C835	10	150	.50
C836	15	150	.53
C837	20	150	.56
C882	30	150	.57
C988	40	150	.65
C838	50	150	.71
C839	60	150	.76
C840	10	250	.56
C841	20	250	.71
C842	10	350	.57
C843	20	350	.76
C844	5	450	.53
C888	8	450	.56
C889	10	450	.62
C845	15	450	.76
C846	20	450	.88
C847	30	450	.97
C849	40	450	1.18
C850	10	500	1.59
C851	10	600	1.73

"TP" Paper Tubulars



Oil treated non-inductive units, wax filled and impregnated. All triple sealed. Not affected by humid climatic conditions. All have wire leads.

No.	Mfd.	Volts	Each
C3896	.01	400	.15c
C3897	.02	400	.15c
C3898	.05	400	.18c
C3899	.1	400	.21c
C3818	.2	400	.24c
C3900	.25	400	.26c
C3901	.5	400	.35c
C3819	1.0	400	.53c
C3902	.0001	600	.15c
C3903	.00025	600	.15c
C3904	.0005	600	.15c
C3905	.001	600	.15c
C3906	.002	600	.15c
C3907	.005	600	.15c
C3908	.006	600	.15c
C3909	.01	600	.18c
C3910	.02	600	.18c
C3820	.03	600	.21c
C3821	.04	600	.21c
C3911	.05	600	.24c
C3912	.06	600	.24c
C3913	.1	600	.26c
C3914	.25	600	.32c
C3915	.5	600	.47c
C3823	1.0	600	.73c

Compact Type TCD and TCS Tubulars



Similar to TC types, extremely compact, averaging one inch in diameter. Hermetically sealed in aluminum casing. Withstand moderately high humidity. Common negative with insulating covering. Type TCS is the same but two independent sections.

Dual Common Negative—Type TCD

Stock No.	Cap. Mfd.	Wkg. Volts	Your Cost
C852	25-25	25	\$0.65
C853	20-20	150	.76
C854	30-30	150	.88
C855	40-40	150	1.00
C856	10-10	250	.88
C857	20-20	250	1.06
C858	10-10	350	.94
C859	20-20	350	1.23
C860	8-8	450	1.00
C861	10-10	450	1.09
C862	15-15	450	1.29
C863	20-20	450	1.41

Dual Separate Section—Type TCS

Stock No.	Cap. Mfd.	Wkg. Volts	Your Cost
C864	15-15	150	\$1.15
C865	20-20	150	1.18
C866	30-30	150	1.35
C867	40-40	150	1.47
C868	10-10	250	1.29
C869	20-20	250	1.59
C870	8-8	350	1.23
C871	15-15	350	1.59
C872	8-8	450	1.29
C873	15-15	450	1.76
C874	20-20	450	1.94

Oil Impregnated Tubulars



Compact oil impregnated paper dielectric condensers available in two types:

OW: oil impregnated and filled. Suitable for vibrators, etc. Paper tube, with mounting bracket. 1600 working volts d.c.

OT: oil impregnated and oil filled. Metal tubes. 2000 wkg. volts d.c.

Type OW (1600 V.D.C.)

No.	Cap. Mfd.	Your Cost
C4011	.0005	EACH 32¢
C4012	.001	
C4013	.002	
C4014	.003	
C4015	.004	
C4060	.005	EACH 35¢
C4016	.006	
C4017	.007	
C4018	.008	
C4062	.01	
C4063	.015	EACH 41¢
C4064	.02	
C4065	.03	
C4066	.04	
C4067	.05	

Type OT (2000 V.D.C.)

No.	Cap. Mfd.	Your Cost
C4021	.0025	.73c
C4022	.005	.73c
C4023	.0075	.73c
C4024	.01	.73c
C4026	.015	.76c
C4027	.02	.79c
C4028	.03	.82c
C4029	.04	.82c
C4030	.05	.85c



Type FP and WP Compact Dry Electrolytics

These capacitors, long considered standard for metal encased units, are ideal for many types of service. Light in weight, compact and provided with a complete mounting feature, they save assembly space and time. Thousands of these units have given excellent service under extreme conditions of high altitudes and humidity.

Stock No.	Cap. Mfd.	Wkg. Volts	Size	Your Cost	Stock No.	Cap. Mfd.	Wkg. Volts	Size	Your Cost
C3700	1000	15	1x3"	\$1.91	C3699	30	350	1x2"	\$1.00
C3701	2000	15	1 1/2 x 3"	2.76	C3707	50	350	1x3"	1.21
C3702	100	25	1x2"	.85	C3658	10	450	1 1/2 x 2"	.76
C3703	500	25	1x3"	1.44	C3659	15	450	1x2"	.91
C3704	1000	25	1 1/2 x 3"	2.09	C3708	20	450	1x2"	1.03
C3705	500	50	1 1/2 x 3"	2.09	C3791	30	450	1x3"	1.15
C3790	50	150	1x2"	.85	C3709	40	450	1x3"	1.32
C3706	100	150	1x3"	1.15	C3681	80	450	1 1/2 x 3"	2.29

Dual Section

Stock No.	Cap. Mfd.	Wkg. Volts	Size	Your Cost	Stock No.	Cap. Mfd.	Wkg. Volts	Size	Your Cost
C3662	30-30	150	1x2"	\$1.03	C3664	10-10	450	1x2"	\$1.23
C3710	50-50	150	1x3"	1.23	C3665	20-20	450	1x3"	1.56
C3793	15-15	350	1x2"	1.23	C3711	40-40	450	1 1/2 x 3"	2.35
C3792	20-20	350	1x3"	1.38	C3712	80-10	450	1 1/2 x 3"	2.50

Multiple Section

Stock No.	Cap. Mfd.	Wkg. Volts	Size	Your Cost
C3713	20-20-20	150	1x2"	\$1.29
C3795	40-40-10	150	1x3"	1.53
C3714	10-10-10	350	1x2"	1.41
C3670	10-10-10	450	1x3"	1.47
C3798	15-15-10	450	1x3"	1.68
C3715	(40-20)(20)	(150)(25)	1x2"	1.35
C3716	(50-30)(100)	(150)(25)	1x3"	1.76
C3717	(15-10)(20)	(350)(25)	1x2"	1.35
C3718	(30-10)(20)	(350)(250)	1x3"	1.68
C3719	(30-20)(20)	(350)(25)	1x3"	1.65
C3668	(10-10)(20)	(450)(25)	1x2"	1.38
C3799	(20-20)(20)	(450)(25)	1x3"	1.73
C3720	(40-40)(20)	(450)(25)	1 1/2 x 3"	2.15
C3721	(40-10-30)(20)	(150)(25)	1 1/2 x 2"	1.82
C3673	(15-15-10)(20)	(450)(25)	1 1/2 x 2"	2.00
C3722	(20-15)(20-20)	(450)(25)	1 1/2 x 2"	2.00
C3723	(40-30-10)(20)	(450)(25)	1 1/2 x 3"	2.47
C3724	10-10-10-10	450	1 1/2 x 2"	1.91

Mounting Plates For Above Condensers

For 3/4" dia. cans	C3674—Bakelite	C3677—Metal	Any Type 3¢ ea.
For 1" dia. cans	C3675—Bakelite	C3678—Metal	
For 1 1/4" dia. cans	C3676—Bakelite	C3679—Metal	

Alum. Can Dry Electrolytic Capacitors

A high quality line of compact round can type filter condensers. Furnished complete with palmnut and flat washer. All have color coded insulated leads. Shpg. wt. 8 oz.

Stock No.	Mallory Type	Cap. Mfd.	Wkg. Volts	Dimensions	Your Cost
C3964	RS213	8	450	1 x 2 1/4"	\$1.03
C4058	HS693	8	600	1 1/2 x 4"	2.35
C3966	RS215	12	450	1 x 2 1/4"	1.26
C3967	RS216	16	450	1 x 3 1/4"	1.41
C3969	RS219	20	450	1 1/2 x 3"	1.56
C3970	RS223	30	450	1 1/2 x 3"	1.76
C3971	RS224	40	450	1 1/2 x 3"	2.00
C3972*	RM262	8-8	450	1 1/2 x 3 1/4"	1.62

*Separate Sections, insulated leads.

Cardboard Tubular Dry Electrolytics



In waxed cardboard tubes furnished with an adjustable strap for horizontal mounting. Insulated leads. Mallory type numbers marked (*) have leads out both ends. The other types have all leads out one end only. The convenience of the insulated leads and the mounting ease make these capacitors popular for replacement and original application.

Single Section—Type ST

Stock No.	Mallory Type	Cap. Mfd.	Volts DC	Dimensions	Your Cost
C3734	ST595	8	450	3/4 x 2 1/2"	\$0.68
C3735	ST597	16	450	1 1/16 x 2 3/4"	.91
C3736	ST598	20	450	1 x 2 1/2"	1.00
C3737	ST599	30	450	1 x 3 1/2"	1.09

Dual—Type 2N—Common Negative

Stock No.	Mallory Type	Cap. Mfd.	Volts DC	Dimensions	Your Cost
C3738	2N509*	20-20	150	7/8 x 2 3/8"	.76
C3739	2N513*	30-30	150	7/8 x 2 3/8"	.88
C3740	2N514*	40-20	150	7/8 x 2 3/8"	.88
C3741	2N511*	40-40	150	1 x 2 3/8"	1.00
C3742	2N520*	50-30	150	1 x 2 3/8"	1.00
C3743	2N521	50-50	150	1 1/8 x 2 3/8"	1.21
C3744	2N518	8-8	450	1 1/8 x 2 3/8"	1.12

Triple—Types 3N and TN—Common Negative

Stock No.	Mallory Type	Cap. Mfd.	Volts DC	Dimensions	Your Cost
C3745	3N527*	(20-20)(20)	(150)(25)	1 1/8 x 2 3/8"	1.12
C3746	3N533*	(30-30)(20)	(150)(25)	1 x 2 3/8"	1.15
C3747	TN125*	20-10	150	7/8 x 2 1/2"	1.09
C3748	TN129	40-20	150	1 1/8 x 2 3/8"	1.35



Cornell-Dubilier "Quietones"

Most satisfactory results are obtained when Quietones are installed at the source of the interference. Where source of interference cannot be located a Quietone connected to the electric supply line of the radio receiver will alleviate, if not fully correct, the condition. Each has plug end and receptacle.

IF-19-21



IF-18

For These	Use	For These	Use
Adding Machines	IF-18	Cash Registers	IF-18
Addressing Machines	IF-18	Dishwashers	IF-19
Billing Machines	IF-18	Flour Polishers	IF-18
Dental Machines	IF-19	Food Mixers	IF-19
Dictating Machines	IF-19	Fans	IF-19
Drilling Machines	IF-19	Juice Extractors	IF-19
Washing Machines	IF-19	Massagers	IF-19
Air Conditioners	IF-18	Radioes	IF-18
Auto Call Systems	IF-18	Refrigerators	IF-18
Barber Clippers	IF-21	Vacuum Cleaners	IF-6

IF-21. All-Wave capacitive-inductive filter. For 110 V., 1.5 amps. max. In Walnut bakelite case. Shpg. wt. 2 lbs.
C12495—Your Cost Each **\$2.35**
 IF-19. Like above, but 5 amps. max.
C12494—Shpg. wt. 2 lbs. Your Cost Each **\$4.12**
 IF-18. All-Wave capacitive-inductive filter. For 110 volts, 5 amps. max. In Walnut bakelite case. Shpg. wt. 5 lbs.
C12493—Your Cost Each **\$4.91**
C12425—IF-6—Your Cost Each **\$1.03**

Special Type "Quietones"

IF-22A. For use with Schick, Knapp Monarch, etc. shavers. Black bakelite case. Wt. 1 lb.
C12496—Your Cost Each **\$1.62**
 IF-22B. Like above, but for Packard Zephyr, Remington-Rand, Ronson, etc. shavers.
C12497—Your Cost Each **\$1.62**
 IF-27. Capacitive-inductive filter for severe interference from oil burners, motors, etc. For 110 V., 5 amps. max. Steel box; flexible leads.
C12498—Shpg. wt. 5 lbs. Each **\$4.12**
 IF-28. Same as above, but for equipment drawing up to 10 amps. max. Shpg. wt. 7 lbs.
C12499—Your Cost Each **\$7.35**

"Industrial Quietone"

IF-7A capacitive-inductive type heavy duty filter for eliminating noises caused by motors, oil burners, diathermy machines, elevators, etc. In steel cutout box 6x6x4", with knock-outs for BX cable or conduit. For single phase 110-220 volts ac. or d.c. at 5 amps. Wt. 9 lbs.
C12500—Each **\$7.35**



MALLORY Interference Filters

X-3 Plug-in Capacitive type for use between set and outlet. Rated 5 amps. at 110-220 volts. For slight interference. 1 1/2 x 2 1/4".
C12510—Each **\$1.06**
Z-2. Capacitive-inductive. 3amps. at 110-220 v. 1 1/2 x 2 1/4".
C12511—Each **\$1.29**

DeLuxe "Plug-In"

Z-6. A dual inductance-capacity filter with provision for return lead to ground. Recommended for suppressing severe interference. Rated 110-220 volts, 3 amps. Use at radio or noise source. 1 1/2 x 3 1/2".
C12516—Each **\$2.12**



W-7 Motor Type

Dual capacity unit. Use on motor brushes or rings. Bracket for mtg. to frame. For moderate interference. 110-220 volts. 1 1/2 x 2 1/4".
C12512—Each **79¢**
W-11. Like above, for severe interference. 1 3/4 x 3".
C12513—Each **\$1.23**

Heavy Duty Type LB Industrial Filters

For use with equipment that is permanently connected to the power line or which draws 10 amps. or more. Contains capacitors and chokes in standard type metal cut-out boxes. Installation is made by cutting the power line as close as practical to the offending device, and inserting the proper LB filter in series with the line at this point. Instructions enclosed. For 110 or 220 volts AC or DC.

No.	Amps.	Size	Wt. Each
C12517	10	6x 6x4	12 lbs. \$10.29
C12518	20	10x10x6	18 lbs. 27.93
C12519	40	12x10x6	25 lbs. 34.54



Heavy Duty Filters

LC-5. Inductance-capacity filter for severe interference. Rated 110-220 V., 5 amps. Has cord, plug and receptacle. 2 1/2 x 3x3 1/2" high. Case has mtg. flanges. Wt. 8 lbs.
C12514—Your cost **\$6.61**
LC-10. Same as above, rated 110-220 V., 10 amps.
C12515—Each **\$8.82**



MALLORY X-6 Noise Filter

For medium interference. Furnished in an attractive compact rectangular brown plastic case to match any surroundings. Merely plug into wall socket, then plug either offending appliance or the affected receiver into receptacle provided. Size: 1 1/2 x 2 1/2 x 1". Rated at 5 amperes on 110 volts, AC or DC.

C12509—Your Cost **94¢**



Reliance "Mites" Ultra Compact Dry Electrolytic Condensers



Ultra compact units that can be used in a large percentage of radio repair requirements. Especially well suited for use in a c.-d.-c. midsets, and wherever space is limited. Self-supporting wire leads are permanently attached to the end plates. All have cardboard outer sleeves. Conservatively rated.

Stock No.	Cap. Mfd.	Wkg. Vlt.	Size In.	Your Cost
C757	10	25	3/8x1 1/8	26c
C758	25	25	3/8x1 1/8	31c
C3275	5	50	1/2x1 1/8	28c
C3276	10	50	1/2x1 1/8	30c
C759	25	50	1/2x1 1/8	35c
C3277	50	50	1/2x1 1/8	43c
C760	4	150	1/2x2 1/8	26c
C761	8	150	1/2x2 1/8	28c
C762	12	150	1/2x2 1/8	30c
C763	16	150	1/2x2 1/8	35c
C764	20	150	1/2x2 1/8	37c
C3278	30	150	1/2x2 1/8	41c
C765	40	150	1/2x2 1/8	41c
C3279	4	250	3/8x1 1/8	28c
C3280	8	250	3/8x1 1/8	31c
C3281	12	250	3/8x1 1/8	41c
C3282	16	250	3/8x1 1/8	47c
C3283	20	250	3/8x1 1/8	51c
C3284	40	250	3/8x1 1/8	59c

Stock No.	Cap. Mfd.	Wkg. Vlt.	Size In.	Your Cost
C766	4	450	1/2x2 1/8	34c
C767	8	450	1/2x2 1/8	37c
C768	12	450	1/2x2 1/8	41c
C769	16	450	1/2x2 1/8	46c
C770	20	450	1/2x2 1/8	52c
C790*	10-10	50	3/8x2 3/8	50c
C3285*	8-8	150	1/2x2 3/8	51c
C3287*	20-20	150	1/2x2 3/8	45c
C792*	8-16	200	1/2x2 3/8	52c
C793*	16-16	200	1/2x2 3/8	64c
C794*	8-8	450	1/2x2 3/8	62c
C3289*	8-16	450	1/2x2 3/8	84c
C3290†	20-20	150	1/2x2 3/8	85c
C3296†	8-8	450	1/2x2 3/8	85c

*—1 leads; †—4 leads.
Buy in Quantity and Save! In Lots of 25 assorted an additional 10% discount may be deducted.

Reliance Midget Paper Cartridge Condensers



Ideal for A.C.-D.C. sets or wherever space is a factor. Highest quality at lowest prices. Finest metal foil and linen paper. Hermetically sealed and impregnated. Supplied in a wide variety of capacities and working voltages to meet practically every service requirement. All provided with long tinned wire leads; units can be made self-supporting.

Stock No.	Cap. Mfd.	Work. Volts	Your Cost
C3179	.01	400	9c
C3180	.02	400	
C3181	.05	400	
C3182	.1	400	
C3183	.25	400	12c
C3174	.5	400	
C3172	1.0	400	20c
C3184	.001	600	
C3185	.002	600	28c
C3186	.006	600	
C3187	.01	600	9c
C3188	.02	600	
C3189	.05	600	12c
C3190	.1	600	
C3191	.25	600	14c
C3169	.5	600	

Midget Molded Micacs

Tiny mica condensers in molded bakelite housings. Provided with pigtail wire leads. Sizes through .004 mfd. are 1000 v. test, 500 v. d.c. w.k.g.; above .004 mfd. are 600 v. d.c. test, 300 v. d.c. w.k.g.

Stock No.	Cap. Mfd.	Your Cost	Stock No.	Cap. Mfd.	Your Cost
C3438	.00001	8c	C3411	.0005	9c
C3439	.000025	8c	C3402	.0006	9c
C3403	.00005	8c	C3416	.001	11c
C3405	.0001	8c	C3400	.0015	11c
C3440	.00015	8c	C3418	.002	14c
C3407	.0002	8c	C3404	.003	18c
C3408	.00025	8c	C3446	.004	21c
C3409	.0003	9c	C3406	.005	23c
C3441	.0004	9c	C3401	.006	28c

*—3/4" square; others 1/2x1/4".

Dry Electrolytic Condensers

"Metal-Can" type in insulated cylindrical screw base aluminum cans with 6" flexible insulated leads. Walnut for mounting. Maximum protection against humidity. For upright mounting.

Stock No.	Mfd.	Vlt.	D.-L.	Each
C810	16	450	1/8x3 1/8	\$0.95
C811	20	450	1/8x3 1/8	.89
C812	30	450	1/8x3 1/8	1.15
C813	40	450	1/8x3 1/8	1.32

ICA "FILTERVOLTS"

All-Wave Model—Contains heavy duty R.F. chokes, large filter capacitors and has "PI" filter unit. Eliminates noises caused by electric heating pads, irons, toasters, vacuum cleaners, etc. Rated 250 watts. at 32, 110 and 220 volts a.c. or d.c. For use with any all-wave or broadcast receivers. Metal case 5x1x4 1/2". Has cord, plug and receptacle. Wt. 5 lbs. **\$4.41**
C12508—Each

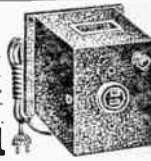

Intermediate Model

Eliminates extremely noisy radio reception due to power line disturbances caused by lights, electrical appliances, etc. Can be installed at set or at source of interference. Metal case has receptacle, cord, plug, and ground binding post. Size: 4 1/2 x 3 3/8 x 1 1/2". Shpg. wt. 2 lbs.
C12507—Each **\$2.65**



SOLAR and AEROVOX CONDENSERS



"MINICAP"

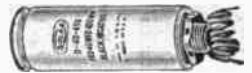

TYPE "D"



TYPE "DY"



TYPE "DS-B"

SOLAR Dry Electrolytic CONDENSERS

The "MINICAP" Dry Electrolytics are small hermetically sealed metal cased units with cardboard insulating tube. Single units have axial bare wire leads. Dual units have negative common, three bare wire leads and metal mounting strap. Ideal for under chassis mounting. Type D is of highest quality, metal cased. Insulated can unit with flexible leads. Provides excellent protection against humidity. Mounts in 3/8" hole. Type "DY Twist Prong" is a standard metal cased unit. Hermetically

sealed base assures long life, proper venting and great rigidity. Ideal for many types of service. Light in weight, compact, and provided with one bakelite and one metal mounting plate. They save assembly space and time. Terminal codes clearly stamped on case.

Type DS-B are single, dual and triple section condensers in impregnated, wax coated cardboard tubes with sturdy center mounting straps. Mounts to chassis with only one screw. 5" long color-coded leads.

"MINICAP" Dry Electrolytics

Stock No.	Mfd.	W. Volts	Size	Each	Stock No.	Mfd.	W. Volts	Size	Each	Stock No.	Mfd.	W. Volts	Size	Each
C2850	10	25	1 1/2 x 1 1/8	\$0.44	C2860	24	150	3/8 x 1 1/8	\$0.56	C2870	10	450	3/4 x 1 1/8	\$0.62
C2851	25	25	1 1/2 x 1 1/8	.50	C2861	30	150	3/4 x 1 1/8	.59	C2871	16	450	3/8 x 2 1/8	.79
C2852	50	25	3/4 x 1 1/8	.59	C2862	40	150	3/4 x 2 1/8	.65	C2872	20	450	1 x 2 1/8	.88
C2853	10	50	1 1/2 x 1 1/8	.47	C2863	8	250	3/4 x 1 1/8	.47	C2873	30	450	1 x 2 1/2	.97
C2854	25	50	3/4 x 1 1/8	.53	C2864	16	250	1 x 1 1/2	.65	C2874	40	450	1 1/2 x 2 1/8	1.18
C2855	100	50	3/4 x 1 1/8	.88	C2865	10	350	1 1/8 x 1 1/8	.59	C2875	8	525	3/8 x 2 1/8	.76
C2856	8	150	1 1/2 x 1 1/8	.47	C2866	20	350	1 1/8 x 1 1/8	.76	C2876	16	525	1 x 2 1/2	1.18
C2857	12	150	3/4 x 1 1/8	.50	C2867	40	350	1 1/8 x 2 1/8	.97	C2877	20-20	150	3/8 x 2 1/8	.76
C2858	16	150	3/4 x 1 1/8	.53	C2868	4	450	3/8 x 1 1/8	.53	C2878	30-30	150	1 1/8 x 1 1/8	.88
C2859	20	150	3/4 x 1 1/8	.56	C2869	8	450	1 1/2 x 1 1/8	.56	C2879	40-40	150	1 1/2 x 2 1/8	1.00

Type D Dry Electrolytics

Stock No.	Mfd.	W. Volts	Size	Each
C2880	50-30	150	1 1/8 x 2 1/8	\$1.00
C2881	50-50	150	1 1/8 x 2 1/8	1.09
C2882	80-40	150	1 1/8 x 2 1/8	1.18
C2883	8-8	450	7/8 x 2 1/8	1.00

Type DY "TWIST PRONG" Mounting

Stock No.	Mfd.	W. Volts	Size	Each	Stock No.	Mfd.	W. Volts	Size	Each	Stock No.	Mfd.	W. Volts	Size	Each
C2890	3000	10	1 1/2 x 3	\$2.65	C2911	20	525	1 x 3	\$1.56	C2932	40-20/100	150/25	1 x 2 1/2	\$1.76
C2891	1000	15	1 x 3	1.91	C2912	20-20	150	1 x 2	.91	C2933	50-30/30	150/25	1 x 2 1/2	1.44
C2892	2000	15	1 1/2 x 3	2.76	C2913	30-30	150	1 x 2	1.03	C2934	15-15/20	350/25	1 x 3	1.50
C2893	25	25	1 x 2	.62	C2914	40-20	150	1 x 2	1.03	C2935	30-30/50	350/50	1 1/2 x 3	1.79
C2894	100	25	1 x 2	.85	C2915	50-30	150	1 x 2	1.15	C2936	20-20/20	450/25	1 x 3	1.73
C2895	500	25	1 x 3	1.44	C2916	50-50	150	1 x 3	1.23	C2937	10-10/10	450	1 x 3	1.47
C2896	1000	25	1 1/2 x 3	2.09	C2917	80-40	150	1 x 3	1.32	C2938	15-15-15	450	1 x 3 1/2	1.79
C2897	500	50	1 1/2 x 3	2.09	C2918	15-15	350	1 x 2	1.23	C2939	20-20-20	450	1 1/2 x 3	2.03
C2898	20	150	1 x 2	.71	C2919	20-30	350	1 x 2 1/2	1.38					
C2899	40	150	1 x 2	.79	C2920	40/20	150/50	1 x 2	1.00					
C2900	80	150	1 x 2 1/2	1.03	C2921	10/25	450/50	1 x 2	1.18					
C2901	20	350	1 x 2	.91	C2922	10-10	450	1 x 2 1/2	1.23					
C2902	30	350	1 x 2	1.00	C2923	20-20	450	1 x 3 1/2	1.56					
C2903	50	350	1 x 2	1.21	C2924	30-30	450	1 1/2 x 3	1.91					
C2904	10	450	1 x 2	.76	C2925	40-40	450	1 1/2 x 3	2.35					
C2905	20	450	1 x 2 1/2	1.03	C2926	20-20-20	150	1 x 2	1.35					
C2906	30	450	1 x 3	1.12	C2927	40-40-40	150	1 x 3	1.53					
C2907	40	450	1 x 3 1/2	1.32	C2928	40-20-10	150	1 x 2 1/2	1.38					
C2908	50	450	1 x 3 1/2	1.68	C2929	40-30-20	150	1 x 2 1/2	1.44					
C2909	80	450	1 1/2 x 3 1/2	2.26	C2930	80-40-20	150	1 x 3	1.65					
C2910	10	525	1 x 3	1.03	C2931	30-20/25	150/25	1 x 2	1.32					

Type DS-B

Stock No.	Cap.	Voltage	Size	Your Cost
C2767	20-20-20	150	1 x 2 1/2	\$0.62
C2768	40-30-20	150	1 x 3	.76
C2769	80-40-20	150	1 1/2 x 3 1/2	.88
C2770	40-10/20	150/25	1 x 2 1/2	1.00
C2771	30-20/20	150/25	1 x 2 1/2	1.00
C2772	40-30/20	150/25	1 x 3	1.09
C2773	50-50/20	150/25	1 1/2 x 3	1.18
C2774	40-40/40	150/25	1 x 3 1/2	1.18

*Separate sections—all others common negative.

AEROVOX Dry Electrolytic CONDENSERS

"DANDEE"

Ultra-Compact Tubular Dry Electrolytics are space saving yet full rated capacity and voltage. Ideal for midgets, AC-DC and auto radios where maximum capacity and working voltages are required in a minimum of space. Varnished paper insulating jacket over can. Dual units have two leads plus common negative. Riveted center mounting strap.

Stock No.	Cap.	Wkg. Mfd. Volts	Size	Each
C701	25	25	9/8 x 1 1/8	\$0.50
C703	25	50	1 1/8 x 1 1/8	.53
C5053	100	50	1 1/2 x 2 1/8	.88
C749	16	150	1 1/2 x 1 1/8	.53
C751	30	150	1 1/2 x 1 1/8	.59
C723	8	250	1 1/2 x 1 1/8	.47
C724	12	250	1 1/2 x 1 1/8	.59
C725	16	250	1 1/2 x 2 1/8	.65
C737	8	350	1 1/2 x 1 1/8	.53
C738	12	350	1 1/2 x 2 1/8	.65
C739	16	350	1 1/2 x 2 1/8	.73
C5054	24	350	1 1/2 x 2 1/8	.79
C753	4	450	1 1/2 x 1 1/8	.53
C755	12	450	1 1/2 x 1 1/8	.68
C756	16	450	1 1/2 x 2 1/8	.79
C5055	20	450	1 1/2 x 2 1/8	.88
C704	10-10	50	3/4 x 2 1/8	.68
C5057	8-8	150	1 1/2 x 2 1/8	.68
C5058	8-16	150	1 1/2 x 2 1/8	.71
C5060	8-8	200	1 1/2 x 2 1/8	.73
C5063	8-8	450	1 x 2 1/8	1.00

Type PRV Universals

Cardboard electrolytics. A thoroughly satisfactory unit for universal top chassis mounting. Takes the place of standard aluminum can electrolytics requiring a hole in chassis for mounting.

Stock No.	Cap.	Wkg. Mfd. Volts	Size	Each
C4705	8	600	1 1/2 x 4 1/2	\$1.73
C4706	8	450	1 1/2 x 4	.68
C4712	40	450	1 1/2 x 4	1.29
C4713	8-8	450	1 1/2 x 4	1.35

Inverted Dry Electrolytics

Screw mounted, supplied with lock-washer nut, 3/8" screw bushing. All have two 8" color-coded leads per section for terminals. Available in single and double section units. Insulated large size can.

Stock No.	Cap.	Wkg. Mfd. Volts	Size	Each
C4517	8	600	1 1/2 x 4 1/2	\$2.35
C4652	8	450	1 1/2 x 4	1.03
C4653	12	450	1 1/2 x 4	1.26
C4654	16	450	1 1/2 x 4	1.41
C4656	8-8*	450	1 1/2 x 4	1.62
C4686	8-16*	450	1 1/2 x 4	1.91
C4574	16-16*	450	1 1/2 x 4	2.06
C4664	8	450	1 x 2 1/2	1.03
C4666	16	450	1 x 3 1/2	1.41
C4518	8-8*	450	1 1/2 x 3	1.62

*Each section has 2 leads.

Metal Can Dries

Standard size inverted units furnished in grounded can mounting type only. Aerovox type G-450. 3/8" bushing.

Stock No.	Cap.	Wkg. Mfd. Volts	Size	Each
C4510	12	450	1 1/2 x 4 1/2	\$1.26
C4511	16	450	1 1/2 x 4 1/2	1.41

Paper Tubulars

Non-inductively wound, fully wax impregnated. All have pigtail wire leads.

High quality, small size, inexpensive units. Completely sealed in wax impregnated tubes with filled ends.

400 Volts Working

No.	Mfd.	Each	No.	Mfd.	Each
C4731	.01	15c	C4734	.03	18c
C4733	.02	15c	C4735	.05	18c

600 Volts Working

No.	Mfd.	Each	No.	Mfd.	Each
C4737	.01	21c	C4741	.05	35c
C4739	.025	26c	C4742	1.0	53c

No.	Mfd.	Each	No.	Mfd.	Each
C4747	.002	15c	C4752	.01	18c
C4748	.003	15c	C4753	.015	18c
C4750	.006	15c			

No.	Mfd.	Each	No.	Mfd.	Each
C4754	.02	18c	C4758	.1	26c
C4755	.03	21c	C4760	.25	32c
C4756	.05	24c	C4762	.5	47c



"DANDEE"



INVERTED



PAPER



PRV UNIVERSAL



METAL CAN



GENERAL ELECTRIC Industrial Capacitors

Pyranol filled high voltage capacitors in hermetically sealed metal containers with pre-mounted rigid base brackets. Porcelain insulators. Screw terminals. Sizes given are overall dimensions.

No.	MFD	W.V.	H x D x W	Each	No.	MFD	W.V.	H x D x W	Each
C3768	1	600	3 7/8 x 1 1/2 x 1 1/2	\$2.60	C3758	4	1500	5 1/2 x 1 1/2 x 3 3/4	\$6.30
C3769	2	600	4 3/8 x 1 1/2 x 1 1/2	3.15	C3759	1	2000	4 7/8 x 1 1/2 x 2 1/2	4.43
C3770	4	600	4 3/8 x 1 1/2 x 2 1/2	4.08	C3760	2	2000	5 1/2 x 1 1/2 x 3 3/4	4.81
C3753	1	1000	3 1/2 x 1 1/2 x 1 1/2	2.77	C3654	4	2000	6 1/2 x 1 1/2 x 3 3/4	6.66
C3754	2	1000	5 1/2 x 1 1/2 x 1 1/2	3.70	C3651	1	3000	5 7/8 x 1 1/2 x 3 3/4	8.85
C3755	4	1000	5 1/2 x 1 1/2 x 2 1/2	4.63	C3652	2	3000	6 1/2 x 1 1/2 x 3 3/4	11.11
C3756	1	1500	5 1/2 x 1 1/2 x 1 1/2	3.33	C3653	4	3000	5 1/2 x 3/4 x 4 1/2	16.29
C3757	2	1500	5 1/2 x 1 1/2 x 2 1/2	4.63					

PLASTICON Capacitors

Sturdily built plastic film dielectric capacitors which are smaller, lighter and more economical. These units have been specified by Signal Corps, Air Corps and Navy for more severe operating conditions than other oil filled types. Extremely wide temperature range, greater safety factor, closer tolerances all insure much longer life. Complete with mounting brackets as illustrated and six-months guarantee slip. These nationally advertised condensers are without comparison. If weight is a factor, specify "Plastics." Average weight saving of 10% over low voltage types and as much as 90% on the higher voltage types. Operate continuously at 220 degrees F.

Rectangulars				Ovals			
Stock Cap. Volts	No. Mfd.	DC.	Your Cost	Stock Cap. Volts	No. Mfd.	D.C.	Your Cost
C2158	4	600	3 1/2 x 2 1/2 x 1 1/2	C2162	2	3000	4 x 3 3/4 x 1 1/2
C2151	1	1000	2 1/2 x 1 1/2 x 1	C2163	4	3000	4 3/4 x 3 3/4 x 2 1/2
C2159	2	1000	4 x 1 1/2 x 1	C2164	1	4000	4 x 3 3/4 x 1 1/2
C2153	4	1000	4 x 2 1/2 x 1 1/2	C2165	2	4000	4 x 3 3/4 x 1 1/2
C2154	8	1000	4 3/8 x 3 3/8 x 1 3/4	C2166	2	5000	3 1/2 x 3 3/4 x 4 3/8
C2160	1	2000	3 1/2 x 1 1/2 x 1				
C2156	2	2000	3 1/2 x 2 1/2 x 1 1/2				
C2157	4	2000	3 1/2 x 3 3/8 x 1 3/4				
C2161	1	3000	4 x 2 1/2 x 1 1/2				

We can supply a complete line of PLASTICON capacitors ranging up to 10,000 volts. Write us for prices, stating complete specifications. Your correspondence will receive our usual prompt reply.



MALLORY Transmitting and Television Capacitors

Type TZ capacitors are for low power transmitting, industrial and television circuits, as well as power amplifier applications. Type TX are general purpose units for commercial, amateur, broadcast, industrial and television applications. Both are conservatively rated and compact in size.

Type TZ—Round Can

No.	Mfd.	W.V.	Size	Each	No.	Mfd.	W.V.	Size	Each
C4004	2	600	1 3/8 x 3	\$2.73	C4008	4	1000	2 x 3 7/8	\$4.26
C4005	4	600	1 3/8 x 3 1/2	3.65	C4009	5	1500	1 3/8 x 3 1/2	2.97
C4006	1	1000	1 3/8 x 2 3/4	2.53	C4010	1	1500	1 3/8 x 5 1/2	3.20
C4007	2	1000	1 3/8 x 3 1/2	3.20	C4036	2	1500	2 x 4 3/4	4.26

Type TX—Rectangular Can

No.	Mfd.	W.V.	Size	Each	No.	Mfd.	W.V.	Size	Each
C3976	1	600	2 1/2 x 1 1/2 x 1	\$3.06	C3981	2	1000	3 7/8 x 1 1/2 x 1	\$4.47
C3977	2	600	2 1/2 x 1 1/2 x 1	3.82	C3982	4	1000	4 1/2 x 2 1/2 x 1 1/2	5.64
C3978	4	600	4 1/2 x 1 1/2 x 1	5.60	C3983	1	2000	4 x 1 1/2 x 1	4.94
C3979	5	1000	2 x 1 1/2 x 1	2.68	C3984	2	2000	4 1/2 x 2 1/2 x 1 1/2	5.85
C3980	1	1000	2 5/8 x 1 1/2 x 1	3.35	C3985	4	2000	4 x 3 3/4 x 1 1/2	8.08

SANGAMO X'mitting Micas

For low and high power transmitters, power supplies, power amplifiers, etc. Employ the finest ruby mica dielectric. Completely cased in moulded bakelite housings with tapped 6/32 screw terminals on each end. Size: 1 3/4" long, 1/2" thick and 1 1/8" wide (varies slightly with capacitance).

600 Volts Wkg.			1200 Volts Wkg.			2500 Volts Wkg.		
Mfd.	No.	Each	No.	Each	No.	Each	No.	Each
00005	C3051	38c	C3771	41c	C3085	53c		
0001	C3053	38c	C3772	41c	C3077	53c		
00015	C3054	38c	C3773	41c	C3078	59c		
00025	C3056	38c	C3775	41c	C3079	62c		
0005	C3060	38c	C3776	41c	C3076	73c		
001	C3061	38c	C3777	53c	C3082	88c		
002	C3064	41c	C3779	78c		\$1.32		
005	C3069	50c	C3782	\$1.03		1.94		
006	C3070	59c	C3783	1.03		2.03		
01	C3073	82c	C3784	1.63		2.41		
02	C3766	\$1.09	C3845	2.29				

Transmitting CONDENSERS

CORNELL-DUBILIER Transmitting Condensers

"TQ" DYKANOL "A"

Designed to stand up under conditions of severe transient voltages and line surges and continuous duty operation. In cylindrical aluminum containers, with 2 insulated terminals and universal mounting bracket. Maybe mounted in any position.



No.	Mfd.	Wkg.	V.	Dimen.	Each
C2962	2	600	2 1/2	x 2	\$2.91
C2963	4	600	2 1/2	x 2	4.03
C2964	1	1000	1 1/2	x 2	2.47
C2965	2	1000	2 1/2	x 2	3.35
C2966	4	1000	3 1/2	x 2	4.26
C2967	1	1500	2 1/2	x 2	3.12
C2968	2	1500	3 1/2	x 2	4.26
C2969	1	2000	3 1/2	x 2	4.03
C2970	2	2000	4 1/2	x 2	4.47
C2971	4	2000	4 1/2	x 2	6.32
C2972	1	3000	3 1/2	x 3	8.08
C2973	2	3000	5 1/2	x 3	9.85

"TJU" DYKANOL "A"

New universal mounting bracket makes these condensers a better buy than ever. DYKANOL filled and impregnated. Porcelain high tension terminals. Shpg. wt. 1 lb.

No.	Mfd.	Wkg.	V.	Ht.	Each
C2994	1	600	2 1/2		\$3.09
C2995	2	600	2 1/2		3.82
C2996	4	600	3 1/2		4.85
C2997	8	600	3 1/2		7.20
C2997	1	1000	2 1/2		3.38
C2998	2	1000	4		4.41

"TLA" DYKANOL "A"

Filter Capacitors In Sealed aluminum containers 4 1/2 x 1 1/2" (2 mfd. 600 v. and 1 mfd. 1000 v. are 2 1/2" high). Mount in any position. Dykanol dielectric.



No.	Cap.	Mfd.	Wkg.	V.	Each
C4195	2	600			\$2.44
C4196	4	600			3.35
C4197	1	1000			2.23
C4198	2	1000			2.91
C4199	1	1500			2.91

No.	Mfd.	Wkg.	V.	Ht.	Each
C3004	4	1000	4 1/2		5.59
C2958	8	1000	4 1/2		8.08
C2959	10	1000	4 1/2		8.97
C2999	1	1500	4		3.97
C3000	2	1500	4 1/2		5.59
C3005	4	1500	4 1/2		7.50

No.	Mfd.	Wkg.	V.	Ht.	Each
C2960	8	1500	4 1/2		11.17
C3001	1	2000	3 1/2		4.85
C3003	2	2000	4		5.73
C3021	4	2000	3 1/2		8.08
C3019	1	3000	3 1/2		10.73
C3020	2	3000	4 1/2		13.38
C3022	2	5000	6		28.66

CORNELL-DUBILIER X'mitting Micas

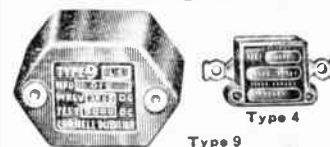

Type 9

Type 4

Stock No.	Cap. Mfd.	C.D. No.	Your Cost
C4156	.00005	4-11050	\$0.41
C4157	.0001	4-13010	.41
C4158	.0002	4-13020	.41
C4159	.00025	4-13025	.41
C4160	.0005	4-13070	.41
C4161	.001	4-12010	.41
C4162	.002	4-12020	.47
C4163	.006	4-12060	.71
C4164	.01	4-11010	.94
C4165	.02	4-11020*	1.29
C4166	.03	4-11030*	1.73

1200 V. Wkg. 2500 V. Test

C4168	.0001	4-23010	\$0.57
C4169	.00025	4-23025	.57
C4170	.0005	4-23050	.57
C4171	.001	4-22010	.73
C4172	.002	4-22020*	1.12
C4173	.005	4-22050*	1.41
C4174	.01	4-21010*	2.29

2500 V. Wkg. 5000 V. Test

C4175	.0001	4-53010	\$0.73
C4176	.0002	4-53020	.82
C4177	.00025	4-53025	.88
C4178	.0005	4-53050	1.00
C4179	.001	4-52010	1.21
C4180	.002	4-52020*	1.82
C4181	.004	4-52040*	2.56
C4182	.005	4-52050*	2.76

All thickness 1/16, except *-7/16. Type 9 Thickness 1/8, except *-7/16.

Moulded in bakelite; mechanically strong; special impregnation; high insulation resistance. No magnetic material—reduces losses at all frequencies. Short, heavy terminals—minimum R.F. and contact resistance. India Mica of gauged thickness. Used for grid and plate blocking purposes.

Type 9

600 V. Wkg. 1000 V. Test

Stock No.	Cap. Mfd.	C.D. No.	Your Cost
C4200	.00005	9-14050	\$0.50
C4201	.0001	9-13010	.50
C4202	.00025	9-13025	.50
C4203	.0005	9-13050	.50
C4204	.001	9-12010	.50
C4205	.002	9-12020	.53
C4206	.01	9-11010	1.15
C4207	.02	9-11020	1.53
C4208	.03	9-11030	2.03
C4209	.04	9-11040	2.65
C4210	.05	9-11050†	3.15

1200 V. Wkg. 2500 V. Test

C4183	.0001	9-23010	\$0.57
C4184	.00025	9-23025	.57
C4185	.0005	9-23050	.57
C4186	.001	9-22010	.73
C4187	.002	9-22020	1.12
C4188	.005	9-22050	1.41
C4189	.01	9-21010	2.29
C4190	.02	9-21020†	3.20
C4191	.03	9-21030†	3.76

2500 V. Wkg. 5000 V. Test

C4211	.0001	9-53010	\$0.73
C4212	.00025	9-53025	.88
C4213	.0005	9-53050	1.00
C4214	.001	9-52010	1.21
C4215	.002	9-52020	1.82
C4216	.004	9-52040	2.56
C4217	.005	9-52050	2.76
C4218	.01	9-51010†	3.35



IRC Insulated Resistors Type BT Metallized



Newly-designed compact size general purpose resistors with a metallized element sheathed in an overall covering of moisture proof phenolic compound. Meet rigid JAN-BF specifications. Non-inductive. Have pig-tail wire leads. Tolerance $\pm 10\%$. 5% available on special order at slightly higher prices. Specify resistance when ordering.

STANDARD RMA CODE—SPECIFY RESISTANCE

Ohms	Ohms	Ohms	Ohms	Ohms	Ohms	Megs.	Megs.
0.47	4.7	47	470	4700	47000	0.47	4.7
0.56	5.6	56	560	5600	56000	0.56	5.6
0.68	6.8	68	680	6800	68000	0.68	6.8
0.82	8.2	82	820	8200	82000	0.82	8.2
1.0	10	100	1000	10000	100000	1.0	10.0
1.2	12	120	1200	12000	120000	1.2	12.0
1.5	15	150	1500	15000	150000	1.5	15.0
1.8	18	180	1800	18000	180000	1.8	18.0
2.2	22	220	2200	22000	220000	2.2	22.0
2.7	27	270	2700	27000	270000	2.7	27.0
3.3	33	330	3300	33000	330000	3.3	33.0
3.9	39	390	3900	39000	390000	3.9	39.0

1/2-Watt—BTS		1 Watt—BTA		2 Watt—BT-2	
Size $1\frac{1}{2} \times \frac{1}{8}$. Meet Spec. JAN-R11 RC10 or RC20. Range 470 ohms to 22 megohms.	Size $1\frac{1}{2} \times \frac{1}{4}$. Meet Spec. JAN-R11 RC30. Range 330 ohms to 22 megohms.	Size $1\frac{1}{2} \times \frac{1}{8}$. Meet Spec. JAN-R11 RC41. Range 470 ohms to 22 megohms.			
C5206—	C5207—	C5263—			
Each..... 8¢	Each..... 10¢	Each..... 15¢			
Lots of 100 of one value	Lots of 100 of one value	Lots of 100 of one value			
Each..... 4¢	Each..... 6¢	Each..... 8¢			

"BW" Insulated Wire-Wound Resistors

Similar to the BT units listed above, but contain a wire wound element, completely encased in molded compound. Tolerance $\pm 10\%$. Order sizes desired from tabulated listing above. Specify Resistance.

1/2-Watt—BW-1/2		1-Watt—BW-1		2-Watt—BW-2	
Size $\frac{1}{2} \times \frac{1}{2}$. Range 0.47 to 820 ohms.	Size $1 \times \frac{1}{2}$. Range 0.47 to 4700 ohms.	Size $1\frac{1}{2} \times \frac{1}{2}$. Range 1.0 to 6800 ohms.			
C5298—	C5299—	C5299—			
Each..... 9¢	Each..... 10¢	Each..... 15¢			
Lots of 100 of one value	Lots of 100 of one value	Lots of 100 of one value			
Each..... 5¢	Each..... 6¢	Each..... 8¢			

Precision Resistors Wire-Wound



Scientifically designed and constructed. Dependable precision meter multipliers and shunts. Guaranteed accuracy 1%. Non-inductively wound. Winding is specially impregnated, which insures constant resistance at all frequencies to 50,000 cycles. WW-2— $2\frac{1}{2} \times \frac{1}{2}$. Has ferrules with binding post terminals. WW-4 has lug type terminals.

Type WW-4		Type WW-2	
Stock No.	Res. Your Cost	Stock No.	Res. Your Cost
C5125 200		C5136 30000	
C5126 300	66¢	C5138 40000	1.04
C5124 500		C5139 50000	
C5127 1000	69¢	C5140 60000	1.22
C5128 2500		C5141 75000	
C5129 5000		C5142 100000	1.42
C5130 7500	76¢	C5099 150000	1.80
C5131 10000		C5100 200000	1.80
C5132 12500	84¢	C5101 250000	1.99
C5133 15000		C5102 300000	2.19
C5134 20000	1.04	C5122 400000	2.29
C5135 25000		C5123 500000	2.60

Type WW-2

C5193 750,000.3	C5202 $1\frac{1}{2}$ Meg.	5.73
C5194 1 Meg.	C5115 2 Meg.	7.64



IRC Basic Resistor Kit

A carefully selected group of most popular resistor values and sizes. You pay for contents only. Cabinet is Free. Kit contains the following:
160 asst. BTS $\frac{1}{2}$ watt res.
115 asst. BTA 1 watt res.
60 asst. BW $\frac{1}{2}$ watt WW res.
20 asst. BW-1 1 watt WW res.
22 asst. AB 10 watt WW res.
8 asst. Volume controls
3 asst. Switches
3 asst. Shafts

All metal cabinet for the bench or wall. Individual, identified compartments. Two drawers and one compartment empty for tools and solder. Attractive yellow, blue and silver finish.
C5291—
Your Cost..... **\$46.93**

IRC Resist-O-Guide

Handy pocket calculator for resistors from .01 ohms to 99 megohms, tolerances of 5% to 20%. Made of durable glazed and waxed cardboard $2\frac{1}{2} \times 4\frac{1}{4}$.
C19747— Your Cost..... **10¢**



IRC Power Wire-Wound Variable Resistors

For all industrial and Radio uses. Dissipate heat rapidly, withstand heavy overloads, have great mechanical strength. All (except 10 watt units) are supplied with a NEW highly improved contact band that has a stainless steel spring spot-welded to it. The spring carries a silver contact button on which the pressure never varies—no torn resistance wire, no corroded contacts. Band is threaded. Mounting brackets with all but the 10-watt units.

Check sizes available in type desired before ordering, as all types are not available in every resistance value listed below.

Ohms	Ohms	Ohms	Ohms
5	250	2500	15000
10	500	3000	20000
25	750	4000	25000
50	1000	5000	40000
100	1250	6000	50000
150	1500	7500	75000
200	2000	10000	100000

Type ABA—10 Watts
 $1\frac{1}{2} \times \frac{1}{2}$. Range up to 10,000 ohms. (See list above).
C5262—
Your Cost Each..... **58¢**

C5213— Extra slider for above.
Your Cost Each..... **8¢**

Type DHA—25 Watts
 $2\frac{1}{2} \times \frac{1}{2}$. Range up to 25,000 ohms. (See list above).

No.	From	To	Each
C5274	5	5,000	73¢
C5275	6,000	15,000	84¢
C5276	20,000	25,000	92¢
C5219—	Extra slider (silver).		16¢

Type EPA—50 Watts
 $4\frac{1}{2} \times \frac{1}{2}$. Available in sizes up to 100,000 ohms. See list above. Each with brackets and one slider.

No.	From	To	Each
C5286	5	5,000	\$1.15
C5287	6,000	25,000	1.26
C5288	40,000	50,000	1.45
C5289	75,000	100,000	1.69

Type ESA—80 Watts
 $6\frac{1}{2} \times \frac{1}{2}$. Available in all sizes as listed at left (except 150, 1250 and 75,000 ohms). Each with brackets and one slider.

No.	From	To	Each
C5196	5	5,000	\$1.49
C5197	6,000	25,000	1.69
C5198	40,000	50,000	1.91
C5199	100,000	2.11

Type HAA—100 Watts
 $6\frac{1}{2} \times 1\frac{1}{2}$. Available in the following resistances.

Ohms	Ohms	Ohms	Ohms
100	2500*	10000*	50000*
500*	5000*	15000	75000*
1000*	7500	25000*	100000*
No.	From	To	Each
C5266	100	5,000	\$1.69
C5267	7,500	25,000	1.91
C5268	50,000	2.11
C5269	75,000	100,000	2.29

Type HOA—200 Watts
 $10\frac{1}{2} \times 1\frac{1}{2}$. In sizes marked by asterisk in list above.

No.	From	To	Each
C5270	500	10,000	\$2.52
C5271	25,000	100,000	2.95

Extra Sliders
Silver contact type to fit sizes listed.
Size Silver Each
50-80W C5217 16¢
100-200W C5218 20¢

IRC Wire Wound Power Resistors

Machine wound on non-hygroscopic cores; cement coating.

Ohms	Ohms	Ohms	Ohms	Ohms	Ohms	Ohms	Ohms
1	75	500*	2000*	4000*	7500*	15000*	40000*
5*	100*	750*	2250	4500	10000*	20000*	50000*
10*	150	1000*	2500*	5000*	12000*	25000*	60000*
25*	200*	1250*	3000*	6000*	12500*	30000*	75000*
50*	250*	1500*	3500	7000*	15000*	35000	100000*

Type "AB" 10-Watt Rating
 $1\frac{1}{2}$ " long, $\frac{1}{8}$ " diam. Range up to 25,000 ohms (see list).
C5210— Up to 10,000 ohms... 34¢ Above 10,000 ohms. Each... 38¢

Type "DG" 20-Watt Rating
2" long, $\frac{1}{8}$ " diam. Range up to 50,000 ohms (see list).
Stk. No. From To Each Stk. No. From To Each
C5211 1 15,000 54¢ **C5212** 20,000 50,000 66¢

Type "EP" 50-Watt (Max.)
 $4\frac{1}{2}$ " long, $\frac{3}{8}$ " diam. Range up to 100,000 ohms. Only in sizes marked with (†) (see list).
Stk. No. From To Each Stk. No. From To Each
C5248 5 5,000 92¢ **C5254** 30,000 100,000 \$1.22
C5249 6,000 25,000 \$1.07

Type "HA" 100-Watt (Max.)
 $6\frac{1}{2}$ " long, $1\frac{1}{8}$ " diam. Range up to 100,000 ohms. Only in sizes marked with asterisk* (see list).
Stk. No. From To Each Stk. No. Resistance Each
C5260 100 5,000 \$1.26 **C5235** 75,000 ohms \$1.91
C5261 7,500 25,000 1.49 **C5236** 100,000 ohms 2.11
C5234 50,000 ohms 1.69

Type "HO" 200-Watt (Max.)
 $10\frac{1}{2}$ " long, $1\frac{1}{8}$ " diam. Range up to 100,000 ohms. Only in sizes marked with (†) (see list).
Stk. No. From To Each Stk. No. From To Each
C5237 100 10,000 \$2.11 **C5238** 15,000 100,000 \$2.52



IRC Resisto-Cabinet

Free with any of the following resistor kits. Sturdy, 4 drawer (7 compartments in each) cabinets $11\frac{1}{2} \times 5\frac{1}{2} \times 5\frac{1}{2}$ ". Blue & Silver finish. Shpg. Wt. 7 lbs.
Kit No. 1: 8 Type BTS $\frac{1}{2}$ W. resistors, 37 type BTA 1 W. resistors, 10-type AB 10 W fixed resistors, 4-type ABA 10W. adjustable resistors. Total 59 resistors.

C5281— List value... \$15.03. Your Cost, Complete... **\$8.84**
Kit No. 2: 100 $\frac{1}{2}$ watt Resistors—6 Type BW- $\frac{1}{2}$, 94 type BTS.
C5280— List value... \$13.12. Your Cost, Complete... **\$7.71**
Kit No. 3: 83 1 watt resistors—6 type BW-1, 77 type BTA.
C5282— List value... \$14.11. Your Cost, Complete... **\$8.30**

"BROWN DEVIL" Fixed Resistors



Wire wound, vitreous enameled units suitable for use on all electronic and industrial equipment. Tinned copper wire terminals. Protected against humidity and mechanical damage. Tol. 10%. Wt. 3 oz.

Ohms	Ohms	Ohms	Ohms
0.4†	125†	1,850†	16,000†
0.6†*	150	2,000	17,500†
0.8†*	200	2,250†	18,000†
1†	225†	2,400††	20,000
1.2†	250	2,500	22,500†
1.3††	300	2,750†	25,000
1.5††	350	3,000	30,000
2†	400	3,500†	35,000
3†	450†	4,000	40,000
4†	500	4,500†	45,000
5	600†	5,000	50,000
7.5††	650††	6,000	55,000*
10	700†	7,000†	60,000*
12††	750	7,500	65,000*
15††	800	8,000	70,000*
20†	850†*	8,500†	75,000*
25	900††	10,000	80,000*
30†	1,000	11,000†	85,000*
35††	1,100†	12,000†	90,000*
40††	1,200†	12,500	95,000*
50	1,250	13,500†	100,000*
60	1,500	14,300†	
75	1,750†	15,000	

5 Watt Resistors

All sizes up to 10,000 ohms except those marked †:

No.	Ohms	Each
C7103	1 to 5000	30c
C7104	6000 to 10,000	33c

10 Watt Resistors

All sizes except those marked*.
C7150—0.1 to 10M ohms... 34c
C7151—11M to 50M ohms... 38c

20 Watt Resistors

All sizes except those marked †.
C7152—0.1 to 15 ohms... 54c
C7153—20M to 50M ohms... 66c
C7154—55M to 100M ohms... 84c

Vitreous Enameled Fixed Resistors



Lug type resistors, wire-wound on porcelain cores. The vitreous enameled coating both protects and insulates the wire. The best alloy and largest possible size wire are used for each resistance. The vitreous enameled coating retains the uniform spacing of the turns, just as they were wound, which permits close spacing. Wire is mechanically locked and soldered to the terminal lugs. Tolerance 10%.

25 WATT

1	150	3,000	25,000
2	200	3,500	30,000
3	250	4,000	35,000
4	500	5,000	40,000
5	750	6,000	45,000
10	800	7,500	50,000
25	1,000	10,000	60,000
50	1,500	12,000	70,000
75	2,000	15,000	80,000
100	2,500	20,000	100,000

Each

C7125—1 to 5M.....	61c
C7126—6M to 15M.....	69c
C7127—20M to 50M.....	84c
C7128—60M ohms.....	96c
C7129—70M ohms.....	\$1.03
C7130—80M ohms.....	1.15
C7131—100M ohms.....	1.45

100 WATT

1	75	1,500	20,000
2	100	2,000	25,000
3	125	2,500	30,000
4	150	3,000	40,000
5	250	5,000	50,000
10	500	7,500	60,000
25	750	10,000	75,000
50	1,000	15,000	100,000

Each

C7139—1 to 5M.....	\$1.26
C7140—7,500 to 25M.....	1.49
C7141—30M to 50M.....	1.69
C7142—60M to 75M.....	1.91
C7143—100,000 ohms.....	2.11

"RITEOHM" Precision Resistors

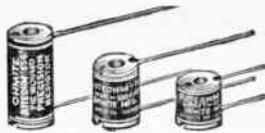

Non inductive, pie-wound units ideal for voltmeter multipliers laboratory equipment, and other applications. Wound on a ceramic bobbin with the highest quality enameled wire. Hole through center for mounting with No. 6 screw. Tolerance 1%. High dielectric strength. Sealed against moisture by vacuum impregnation. All units above 400M are 1 Watt, 400M and below are 1/2 Watt. All are 1/2" dia up to 200M ohms are 1/16" long, 225M through 400M are 1/8" long, rest are 1" long.

Ohms	Ohms	Ohms	Ohms
1	2,000	30M	250M
10	2,500	40M	300M
25	4,000	50M	400M
50	5,000	60M	500M
100	7,500	75M	600M
200	10,000	100M	750M
250	12,500	125M	900M
300	15M	150M	1 Meg.
500	20M	175M	
1000	22,500	200M	
1500	25M	225M	

Specify Resistance When Ordering

No.	Ohms	Each
C7108	1 thru 500	\$0.65
C7109	1000 thru 2500	.69
C7110	4000 thru 10,000	.76
C7111	12,000 thru 15M	.84
C7112	20M thru 50M	1.04
C7113	60M thru 75M	1.22
C7114	100M	1.42
C7115	125M	1.61
C7116	150M thru 200M	1.80
C7117	225M thru 250M	1.99
C7118	300M	2.18
C7119	400M	2.29
C7120	500M	2.60
C7121	600M	3.25
C7122	750M	3.44
C7123	900M	3.64
C7124	1 meg.	4.02



OHMITE "Little Devil" Insulated Resistors



Ready for any job anywhere are these tiny completely sealed and insulated molded plastic constructed resistors meeting all Joint Army/Navy specifications. Soft copper wire pigtail leads. Used in critical equipment and in the nation's foremost laboratories. Dissipate heat rapidly, have low noise level and low voltage coefficient. Tolerance ±10%.

Standard RMA Code—Specify Resistance

Ohms	Ohms	Ohms	Ohms	Megohms	Megohms	Megohms
10	100	1,000	10,000	0.1	1.0	10.0
12	120	1,200	12,000	0.12	1.2	12.0
15	150	1,500	15,000	0.15	1.5	15.0
18	180	1,800	18,000	0.18	1.8	18.0
22	220	2,200	22,000	0.22	2.2	22.0
27	270	2,700	27,000	0.27	2.7
33	330	3,300	33,000	0.33	3.3
39	390	3,900	39,000	0.39	3.9
47	470	4,700	47,000	0.47	4.7
56	560	5,600	56,000	0.56	5.6
68	680	6,800	68,000	0.68	6.8
82	820	8,200	82,000	0.82	8.2

1/2 Watt

Size 3/16" x 3/16".
Max. volts 350.

C7100—

Each..... 8¢

Lots of 100 of one value—Each..... 4c

1 Watt

Size 1/8" x 1/8".
Max. volts 500.

C7101—

Each..... 10¢

Lots of 100 of one value—Each..... 6c

2 Watt

Size 1/4" x 1/4".
Max. volts 1,000.

C7102—

Each..... 15¢

Lots of 100 of one value—Each..... 8c

NOTE: We can supply all RMA standard value resistors in 5% tolerance. Send us your specifications and we will gladly submit quotations.

OHMITE "DIVIDOHM" Adjustable Resistors



Wire-wound units that make ideal voltage dividers for original equipment and replacement in transmitters, rectifiers and other apparatus. Handy for obtaining odd resistance values, for adjusting circuits and for use on equipment which must be set to meet various line voltages. Vitreous enameled on porcelain cores with a narrow strip of the turns of wire exposed to form a contact surface for embossed contact on the adjustable lug. (Every turn is securely held against shifting.) Slider and mounting bracket included.

10 WATT 1 1/2" x 3/4"

5	100	1,000	4,000
10	250	2,000	5,000
25	500	2,500	7,500
50	750	3,000	10,000

C7174—

Your Cost..... 58¢

50 WATT 4" x 3/4"

1	250	3,000	12,000
2	300	3,500	15,000
3	400	4,000	20,000
4	500	4,500	25,000
5	750	5,000	30,000
10	800	6,000	40,000
25	1,000	7,000	50,000
50	1,250	7,200	60,000
75	1,500	7,500	80,000
100	2,000	8,000	100,000
150	2,250	9,000	
200	2,500	10,000	

Each

C7178—1 ohm to 5M.....	\$1.15
C7179—6M to 25M.....	1.26
C7180—30M to 50M.....	1.45
C7181—60M to 100M.....	1.69

25 WATT 2" x 3/4"

5	250	2,500	10,000
10	500	3,000	15,000
25	750	4,000	20,000
50	1,000	5,000	25,000
100	2,000	7,500	

Each

C7175—5 ohms to 5M..... 73c

C7176—7,500 to 15M..... 84c

C7177—20M to 25M..... 92c

100 WATT 6 1/2" x 3/4"

10	250	5,000	25,000
25	500	10,000	30,000
50	1,000	15,000	40,000
100	2,500	20,000	50,000

Each

C7182—10 ohms to 5M..... \$1.69

C7183—10M to 25M..... 1.91

C7184—30M to 50M..... 2.11

200 WATT 10 1/2" x 1 1/4"

5	250	5,000	25,000
10	500	10,000	30,000
25	1,000	15,000	40,000
50	2,500	20,000	50,000

Each

C7185—5 ohms to 10M..... \$2.52

C7186—15M to 50M..... 2.94

Standard Adjustable Sliders

SCREWDRIVER TYPE

Diam. Inches	Stock No.	Your Cost
5/16	C7193	8c
9/16	C7194	8c
1 1/8	C7195	12c
1 1/4	C7196	12c

BAKELITE KNOB TYPE

Stock No.	Your Cost
C7197	12c
C7198	20c
C7199	20c

SPRAGUE "KOOLOHM" Resistors

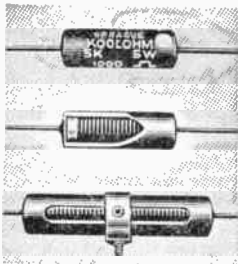

New Tropicalized fixed resistors. Insulation has high dielectric strength, withstands red heat and is impervious to moisture. Units are encased in tubular ceramic shells which permit mounting in contact with metal parts without shorting. 2 1/2" tinned copper wire leads. Meet requirement of television and other high-voltage circuits. Negligible resistance drift. Insulated for 10,000 volts. Accuracy guaranteed ±5%. Non-inductive types show zero inductance up to 50 mc. and distributed capacitance is only 2 mmfd.



CENTRALAB Power Rheostats

Ideal for use as motor speed controls, charging rate regulators, etc. All metal frame; core insulated with treated asbestos. Wire wound. All for single-hole mounting; knob supplied. Diameter 2", bushings 3/4 x 1/2" long. Depth behind panel: 25-watt units 3/4"; 50-watt units 1 1/4". All have tinned solder lug terminals for easy connections. Shipping wt. 1 lb.



25 Watts			50 Watts		
No.	Ohms	Each	No.	Ohms	Each
C8977	2	\$1.18	C8962	2	\$1.47
C8978	6		C8985	10	
C8979	15		C8987	25	
C8980	50		C8988	60	
C8976	100		C8986	100	
C8981	150		C8989	150	

Standard Fixed

Ohms	Ohms	Ohms
10	250	2500
20	300	3000
25	400	5000
30	500	7500
50	750*	10,000
75	1000	12,000*
100	1250	15,000*
150	1500	20,000
200	2000	25,000
300	3000	30,000
500	5000	40,000
750*	7500	50,000*
1000	10,000	60,000*
1250*	12,500*	70,000*
1500	15,000	
2000	20,000	

*—10 watt only. *—10 watt only.
Type 5KT—5 Watts. 1 1/2" x 1 1/4"

No.	Ohms	Each
C7513	10 to 5,000	30c
C7514	7,500 to 10,000	31c
C7515	12,500 to 15,000	35c
C7516	20,000	39c
C7517	25,000	49c
C7518	30,000	53c
C7519	40,000	60c

Type 10KT—10 Watts. 1 1/2" x 1 1/4"

No.	Ohms	Each
C7520	10 to 10M Ohms	34c
C7520	12M, 15M Ohms	38c
C7521	17,500 & 20,000	42c
C7522	25,000	49c
C7523	30,000	53c
C7524	40,000	64c
C7525	50,000	71c
C7526	60,000	88c
C7527	70,000	99c

Standard Adjustable

Type 10AD—10 Watt. 1 1/2" x 1 1/4"
 With adjustable clip.

Ohms	Ohms	Ohms	Ohms
10	200	750	3000
25	250	1000	4000
50	300	1500	5000
100	400	2000	7500
150	500	2500	10,000

C7534—Any above
Your Cost Each..... 58¢

Non-Inductive Fixed

Type 10NI—10 Watt. 1 1/2" x 1 1/4"

Ohms	Ohms	Ohms	Ohms
10	70	500	2500
20	80	750	3000
30	90	1000	3500
40	100	1250	4000
50	250	1500	5000
60	400	2000	7500

Stock No.	Ohms	Each
C7528	10 to 1000	46c
C7529	1250 to 2000	54c
C7530	2500 to 4000	58c
C7531	5000	61c
C7532	7500	69c
C7533	10,000	88c

IRC All Metal Rheostats

All-metal units with die-cast aluminum case. Heat is uniformly distributed throughout the element regardless of percentage of element actually used. Flat clockspring (Silent Spiral Connector) gives positive contact between rotor arm and center connector. 25-Watt units 1 1/2" dia., 1 1/4" behind panel; 50-Watt units 2 1/4" dia., 1 1/2" behind panel. Shpg. wt. 2 lbs.



25-Watt Rheostats			50-Watt Rheostats		
No.	Ohms	Amps.	No.	Ohms	Amps.
C9150	6	2.04	C7746	6	2.88
C9151	10	1.58	C7747	16	1.77
C9152	25	1.00	C7748	50	1.00
C9153	50	.709	C7749	125	.630
C9154	75	.575	C7750	225	.470
C9155	100	.500	C7751	300	.407
C9156	250	.315	C7752	500	.315
C9157	350	.267			
C9158	500	.222	C7753	1000	.223
C9159	750	.173	C7754	2500	.140
C9160	1000	.155			
C9161	1500	.129	C7755	5000	.100
C9162	2500	.100	C7756	10000	.070
C9163	5000	.070			

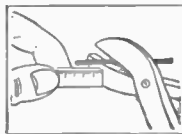

MALLERY Yard-Ohm Resistance Kits

The Yard-Ohm Kit provides a real solution to the odd-value resistor problem. Ideal for meter shunts, for experimental lab, etc. Contain all the necessary materials to construct flexible resistors of a wide range of values. Each kit consists of 1 yard spiral wound resistance wire, 1 yard insulated braid and 24 spiral wire leads. Available in eight resistance values. Dissipation—all types; 1/2 watt per inch. Instructions included.

Stk. No.	Ohms	Your Cost	Stk. No.	Ohms	Your Cost
C4407	1	.707	C4411	50	.100
C4408	5	.315	C4412	100	.071
C4409	10	.223	C4413	250	.044
C4410	25	.111	C4414	500	.031

44¢ AnyType

CONTINENTAL "Nobleloy" X-Type Resistors 1 Watt

New resistor involving the metal film principle, having the accuracy of a wire wound unit. No carbon used. Metallic resistance film is formed on the surface of a low loss ceramic tube, then hermetically sealed by a layer of vitreous enamel. Ceramic tubes are hollow and allow greater area for heat dissipation. Excellent resistance stability and negligible noise characteristics. Will withstand overloads of 200% and temperatures of 400° F without change in value upon return to room temperature. Critical tolerance within 1%. Size 3/8" x 1", 1 1/2" tinned copper leads.



Ohms	Ohms	Ohms	Ohms
1	2950	9950	85M
10	3500	10,000	90M
25	4000	13,500	100M
50	4450	15M	150M
100	4950	20M	200M
200	5000	25M	240M
400	5500	30M	250M
500	5950	40M	300M
1000	7450	50M	400M
1500	8500	60M	450M
2000	8950	75M	490M

C7105—Specify Resistance.
Your Cost Each..... 59¢

OHMITE Model Train Control Rheostats

Ideal for providing realistic single knob starting, stopping, speed and reversal. Will control one "HO" gauge locomotive pulling normal load. Single hole mounting. 2 3/8" dia. x 1 1/8" deep.

C8388—Your Cost..... \$4.41

MT-14 for "O" Gauge

Will control one "O" gauge locomotive pulling normal load. Off position for operating sequence reversers. 2 3/8" x 1 1/8" deep.

C8389—Your Cost..... \$3.67



OHMITE Power Rheostats

Designed to produce permanently smooth, close control. Ceramic and metal construction. Provided with insulated shafts with provision to keep the rheostat from turning on the panel. The resistance wire is wound over a solid porcelain core. Each turn is locked against shifting by vitreous enamel, which also covers the core and base. Requires 3/8" Hole. Wt. 1 lb.



Model "H"—25W (1 1/4" dia.)			Model "J"—50 Watt (2 1/4" dia.)		
Stock No.	Total Ohms	Max. Amps.	No.	Ohms	Amps.
C8350	1	5.000	C7200	0.5	10,000
C8362	2	3.540	C7201	1	7,070
C8351	3	2.880	C7202	2	5,000
C8363	6	2,040	C7203	4	3,530
C8352	8	1,770	C7204	8	2,500
C8364	10	1,580	C7205	12	2,040
C8365	15	1,290	C7206	16	1,760
C8366	25	1,000	C7207	22	1,500
C8353	35	.845	C7208	35	1,190
C8367	50	.707	C7209	50	1,000
C8390	75	.575	C7210	80	.790
C8368	100	.500	C7211	125	.630
C8369	125	.445	C7212	150	.575
C8370	175	.375	C7213	225	.470
C8371	250	.316	C7214	300	.408
C8391	350	.267	C7215	500	.316
C8372	500	.222	C7216	800	.250
C8392	750	.182	C7217	1,000	.224
C8373	1,000	.155	C7218	1,600	.176
C8374	1,500	.129	C7219	2,500	.141
C8375	2,500	.100	C7220	3,500	.119
C8376	3,500	.084	C7221	5,000	.100
C8377	5,000	.070	C7222	8,000	.079
			C7223	10,000	.070

MODEL "K"—100 WATT (3 1/4" DIA.)

No.	Ohms	Amps.	Each	No.	Ohms	Amps.	Each
C8378	10	3.160		C8383	500	.447	\$5.35
C8379	25	2.000		C8384	1,000	.316	\$5.73
C8380	50	1.410	\$5.35	C8385	2,500	.200	
C8381	100	1.000		C8386	5,000	.141	\$6.12
C8382	300	.575		C8387	10,000	.100	\$6.88

MALLORY VOLUME CONTROLS

Standard Universal Tapped Controls

Standard 1 1/2" diameter controls with tap for various applications. Furnished with two nuts, washer, ground terminal and knob adapter. *No provision for use with switch; if switch is desired use TRP624. †Has slotted shaft for auto sets. ‡Special taper for fader service. Others are taper 1. Less switches. Shpg. wt. 5 oz.

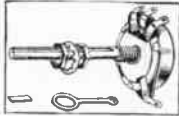

Stock No.	Mfrs. No.	Res. Ohms	Tapped At Ohms	Stock No.	Mfrs. No.	Res. Ohms	Tapped At Ohms
C6543	TRP601	40000	8000	C6588	TRP615	3 Meg.	900000
C6544	TRP602	60000	4000	C6589	TRP616	500000	60000
C6545	TRP603	250000	110000	C6590	TRP617	60000	12000
C6546	TRP604	350000	20000	C6591	TRP618	2 Meg.	250000
C6547	TRP605	500000	70000	C6592	TRP619	500000	250000
C6577	TRP606	500000	100000				
C6578	TRP607	500000	225000	C6593	TRP620	2 Meg.	900000
C6579	TRP608	1 Meg.	200000	C6594*	TRP621	2 1/4 Meg.	250000
C6580	TRP609†	1 Meg.	300000				
C6581	TRP610	1 Meg.	30000	C6595	TRP622	44000	7000
C6583	TRP612	2 Meg.	15000				
C6586	TRP613	2 Meg.	400000	C6596	TRP623	250000	50000
C6587	TRP614‡	350000	70000	C6576	TRP624	2 1/4 Meg.	250000

Your Cost Each, Any of the Above **\$1.09**

Standard Universal Dual Controls

Consists of two volume controls strapped together and driven by a single shaft. Units listed service practically all receivers.

Stock No.	Mfrs. No.	Type	Res. in Ohms	Taper
C6684	CE	WW	2000 5000	Front Rear I I
C6685	GE	WW	10000 5000	VII IV
C6685	GG	WW	10000 10000	VII IV
C6686	GK	Car.	10000 50000	I IV
C6689	LL	Car.	100000 100000	I I
C6687	LM	Car.	100000 250000	I I
C6749	MM	Car.	250000 250000	I I
C6750	NN	Car.	250000 500000	I I
C6659	NN	Car.	500000 500000	I I

WW—Wire Wound element. Car.—Carbon element.
Your Cost Each, Any Size **\$1.82**

Explanation Of Mallory Volume Control Tapers

- No. (1) For audio or antenna shunt circuits.
- No. (2) For series circuits such as cathode voltage controls.
- No. (3) For antenna shunt and "C" bias circuits.
- No. (4) Linear taper; for voltage divider circuits.
- No. (4a) Modified linear taper, similar to No. 4.
- No. (7) Wire wound element. For antenna and "C" bias.

COMPACT RHEOSTATS & POTENTIOMETERS

TYPE C—2 WATTS



Wire Wound. Controls ideal for use where space is limited. Contact arm is grounded to the shaft. Diam. 1 1/2". 1/4" shaft. is 3/4" long.

TYPE M—4 WATTS



Wire Wound. Conservatively rated at 4 watts. Fully enclosed. 1 1/2" diam.; mount in 1/2" hole. Shaft 1/4" diam., 3/8" long. With dust cover.

RHEOSTATS			RHEOSTATS				
No.	Ohms	Ohms	No.	No.	Ohms		
C6197	6	C6201	30	C6480	1	C6486	20
C6198	10	C6202	40	C6481	2	C6487	25
C6199	15	C6203	50	C6482	3	C6173	40
C6200	20	C6204	100	C6483	6	C6174	50
				C6484	10	C6175	60
				C6485	15	C6176	75

POTENTIOMETERS			POTENTIOMETERS				
No.	Ohms	Ohms	No.	No.	Ohms		
C6205	6	C6210	40	C6503	20	C6496	200
C6206	10	C6211	50	C6492	50	C6497	400
C6207	15	C6212	100	C6495	100		
C6208	20	C6213	200				
C6209	30	C6214	400				

Your Cost Each, Any of the Above **73¢**
 C6215—1000ohms }
 C6216—3000ohms } Ea. **82¢**
 C6217—5000ohms }
 C6218—6000ohms }
 C6219—10000ohms } Ea. **97¢**
 C6220—15000ohms }

UNIVERSAL VOLUME CONTROLS

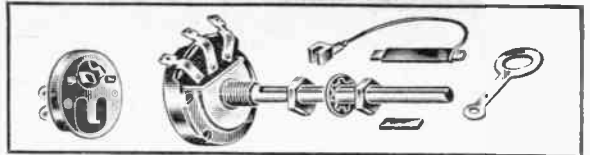

The Mallory-Yaxley Volume Controls listed on these pages can be used to service over 90% of all the radio receivers now in use. With comparatively few units, the serviceman is enabled to meet practically all service requirements. Mallory-Yaxley Controls feature: minimum bias adjustment on all bias controls; 3" shafts that can be shortened by notching and breaking off; complete shielding; all furnished with knob adapter, and mounting hardware. Approved switch (listed below) can be added to any control.

UNIVERSAL REPLACEMENT CONTROLS

All with two mounting nuts, washer, ground terminal and knob adapter. Wire wound units have adjustable bias feature (exclusive Mallory-Yaxley); carbon element units with adjustable bias resistor where required.

No.	Part	Type	Ohms	Taper	No.	Part	Type	Ohms	Taper
C6660	Q	WW	2	4	C6675	H*	WW	15000	2
C6661	R	WW	6	4	C6713	H7*	WW	15000	7
C6662	S	WW	10	4	C6714	II12*	Car.	15000	1
C6663	T	WW	20	4	C6741	A20MP*	WW	20000	4
C6664	U	WW	30	4	C6715	Y*	Car.	20000	1
C6665	V	WW	60	4	C6742	Z5MP	Car.	25000	4
C6666	W	WW	100	4	C6676	J*	Car.	25000	1
C6667	X	WW	200	4	C6743	Y50MP	Car.	50000	4
C6732	A400P	WW	400	4	C6677	K*	Car.	50000	2
C6668	A	WW	500	1	C6716	K12	Car.	50000	1
C6733	A550P	WW	550	4	C6717	Z*	Car.	75000	2
C6734	A1MP	WW	1000	4	C6718	Z12	Car.	75000	1
C6669	B	WW	1000	1	C6744	Y100MP	Car.	100000	4
C6719	UC500	WW	1000	2	C6721	YC510*	Car.	100000	2
C6735	A2MP*	WW	2000	4	C6722	YC509*	Car.	150000	1
C6670	C*	WW	2000	2	C6745	Y200MP	Car.	200000	4
C6704	C12*	WW	2000	1	C6746	Y250MP	Car.	250000	4
C6736	A3MP*	WW	3000	4	C6679	M	Car.	250000	1
C6671	D*	WW	3000	2	C6730	UC511†	Car.	250000	1
C6705	D7*	WW	3000	7	C6728	UC508*	Car.	250000	2
C6706	D12*	WW	3000	1	C6747	Y500MP	Car.	500000	4
C6737	A5MP*	WW	5000	4	C6690	N	Car.	500000	1
C6738	Y5MP	Car.	5000	4	C6731	UC512†	Car.	500000	1
C6672	E*	WW	5000	2	C6793	UC513	Car.	500000	2
C6707	E7*	WW	5000	7	C6722	UC533	Car.	750000	1
C6708	F12*	Car.	5000	1	C6748	Y1000MP	Car.	1 Meg.	4
C6673	F*	WW	7500	2	C6681	O	Car.	1 Meg.	1
C6709	F7*	WW	7500	7	C6794	UC514†	Car.	1 Meg.	1
C6710	F12*	Car.	7500	1	C6682	P	Car.	2 Meg.	1
C6739	A10MP*	WW	10000	4	C6723	UC504	Car.	3 Meg.	1
C6740	Y10MP	Car.	10000	4	C6724	UC505	Car.	4 Meg.	1
C6674	G*	WW	10000	2	C6725	UC506	Car.	5 Meg.	1
C6711	G7*	WW	10000	7	C6726	UC507	Car.	5 Meg.	2
C6712	G12*	Car.	10000	1	C6727	UC508	Car.	9 Meg.	1
C6720	UC501	Car.	10000	2					

Car.—Carbon element. WW—Wire wound. *—Has adjustable bias feature. Wire wound units have adjustable plate; carbon element controls have external adjustable resistor. †—Has slotted shaft for auto sets. Supplied Less Switch.

Your Cost Each, Any of the above Controls **73¢**

Control Switches



Attachable switches to fit all universal, tapped, and dual controls listed on this page.

Stock No.	Part	Type	Each
C6288	6-9 S.P.S.T.		35c
C12853	8 S.P.D.T.		44¢
C6289	7 D.P.S.T.		
C6290	13 3-P.S.T.		
C6291	14 4-P.S.T.		

Mounting Brackets



For use where control mounts off chassis. Plated metal. Adjustable mounting centers.

C6297—Type RB-248—Mounting centers 1 1/2" to 2 3/8".
 C6298—Type RB-249—Mounting centers 2 3/8" to 2 3/8".

Your Cost Each, Either Type **15¢**

Extension Shafts

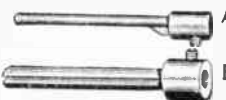

Type A—Length 4".
 C6561—1/2" diam., 1/8" flat.
 C6562—3/4" diam., 3/8" flat.
 C6563—1" diam., 1/2" flat.

Any Size, Your Cost Each **24¢**

Type B—2" long, 3/4" diameter with 3/8" slot. Enclosed in tight fitting tube.

C6559—Your Cost **26¢**

Control Hex Nuts

No.	For Panels	Each
C6384	1/4"	12c
C6386	3/8"	15c
C6385	1/2"	18c

Volume Control Wrench



For standard volume control nuts.

C6387—No. 178 Your Cost Each **15¢**

MALLORY "UM" and "TM" Junior Controls



Ultra-compact controls featuring noiseless composition elements; attachable switches; plug-in type shafts. Both UM and TM types have slotted shafts which will take any one of the 28 different types of special shafts listed below. The TM types are similar to the UM but are provided with a tap as shown. TM type designed for use in tone compensating circuits. All are 1/2" thick, 1 1/4" diameter. Complete with SSI shaft.

MALLORY "UM" Type Junior Controls

Stock No.	Type No.	Ohms & Taper	Stock No.	Type No.	Ohms & Taper	Stock No.	Type No.	Ohms & Taper
C6926	UM114	5M(4A)	C6935	UM133	50M(1)	C6944	UM147	250M(1)
C6927	UM118	10M(1)	C6936	UM134	50M(2)	C6945	UM149	250M(4)
C6928	UM119	10M(2)	C6937	UM135	50M(4)	C6946	UM151	350M(1)
C6929	UM120	10M(4)	C6938	UM137	75M(1)	C6947	UM154	500M(1)
C6930	UM121	15M(1)	C6939	UM138	75M(2)	C6948	UM156	500M(4)
C6931	UM122	15M(2)	C6940	UM140	100M(1)	C6949	UM158	750M(1)
C6932	UM124	20M(1)	C6941	UM141	100M(2)	C6950	UM161	1 Meg.(1)
C6933	UM128	25M(2)	C6942	UM142	100M(4)	C6951	UM163	2 Meg.(1)
C6934	UM129	25M(4)	C6943	UM144	150M(1)	C6952	UM165	3 Meg.(1)

Type UM Controls, complete with SSI shaft. **73¢**
Your Cost, Any Size

MALLORY "TM" Type Tapped Controls

No.	Type	Ohms	Tapped	No.	Type	Ohms	Tapped
C6953	TM221	25M	50M	C6959	TM240	1 Meg.	200M
C6954	TM221	250M	110M	C7006*	TM241	1 Meg.	200M
C7013*	TM222	250M	110M	C7007*	TM242	1 Meg.	450M
C7014*	TM223	500M	60M	C6960	TM243	1 Meg.	450M
C7015*	TM224	500M	100M	C7008	TM244	1 1/2 Meg.	200M
C6955	TM225	350M	70M	C6961	TM245	2 Meg.	5M
C7016	TM226	500M	15M	C6962	TM246	2 Meg.	15M
C7017	TM227	500M	100M	C6963	TM247	2 Meg.	60M
C6956	TM228	500M	5M	C6964	TM248	2 Meg.	250M
C6957	TM230	500M	150M	C6965	TM249	2 Meg.	600M
C6958	TM231	500M	225M	C7009	TM250	2 Meg.	125M
C7018*	TM232	500M	225M	C6966	TM251	2 Meg.	900M
C7019	TM233	500M	60M	C7010*	TM252	2 Meg.	900M
C7020	TM234	1 Meg.	65M	C7011	TM254	2 Meg.	400M
C7021	TM236	1 Meg.	125M	C6967	TM257	3 Meg.	900M
C7022	TM238	1 Meg.	300M	C7012	TM259	2 Meg.	900M
C6864*	TM239	1 Meg.	300M				

Type TM Controls, complete with SSI shaft. **\$1.09**
Any Type Above, Your Cost Each

MALLORY Plug-In Shafts

Fit all UM and TM junior control. Adapt for use with most auto and home radios.

- C6989—SS17. Replaces any slotted "Insacup" shaft to 6" long. **38¢**
- C6992—SS18. For Belmont. **18¢**
- C6993—SS19. Each. **38¢**
- C6994—SS20. Each. **38¢**
- C6995—SS21. Motorola model 171). Each. **26¢**
- C6996—SS22. Each. **18¢**
- C6997—SS23. Each. **18¢**
- C6998—SS24. Each. **18¢**
- C6999—SS25. Replaces standard knurled shafts from 3/4" to 4" long. Each. **18¢**
- C6809—SS26. Zenith sets. **18¢**
- C6810—SS27. Philco sets. **18¢**
- C6820—SS28. Motorola sets. **38¢**
- C6821—SS29. Motorola sets. **18¢**
- C6822—SS30. Motorola sets. **18¢**
- C6826—SS31. Philco sets. **18¢**
- C6827—SS32. Philco sets. **18¢**

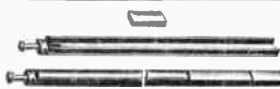

- C6973—SS1. Replaces any 1/2" round shaft or 1/2" or 3/4" flattened shaft up to 4" long. Each. **18¢**
- C6974—SS2. Each. **18¢**
- C6975—SS3. Replaces any 3/4" slotted shaft up to 2" long. **26¢**
- C6976—SS4. Each. **18¢**
- C6977—SS5. Each. **18¢**
- C6978—SS6. RCA, Hudson H6. **18¢**
- C6982—SS10. Each. **18¢**
- C6983—SS11. Replaces any 3/2" slotted shaft 2 to 4" long. **26¢**
- C6984—SS12. Each. **18¢**
- C6986—SS14. Replaces any 1 1/2" slotted shaft to 2" long. **26¢**
- C6987—SS15. Replaces any 3/2" slotted shaft 4 to 6" long. **26¢**
- C6988—SS16. **18¢**

MALLORY "T" & "L" Pads

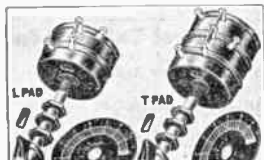

For controlling level of low imp. audio circuits, mikes or phono. etc. With knob, dial and plate.

"L" Pads		"T" Pads	
No.	Ohms Imp.	No.	
C6356	6	C6362	
	8	C6363	
C6357	15	C6364	
C6358	50	C6365	
C6359	200	C6366	
C6381	250	C6382	
C6360	500	C6387	
C6361	2000	C6368	

"L" Pads; Any Type Above. **\$2.20**
"T" Pads; Any Type Above. **\$2.50**

CLAROSTAT 10-Watt Output Attenuators

Type C1B: Compact constant impedance attenuators that will dissipate 10 watts in any position. Ideal for individual speaker controls. Linear attenuation in 3 db steps to 30 db final step to infinity. Units are 2" dia., 2 3/4" long. Mount in single hole. Bushing 3/8"; shaft 1" long. Supplied with dial plate and knob. Shpg. wt. 1 lb.

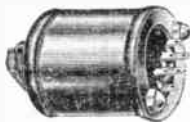

No.	Ohms	No.	Ohms	No.	Ohms	Any Type, Each
C7837	8	C7839	50	C7841	250	\$6.37
C7838	15	C7840	200	C7842	500	

MALLORY VOLUME CONTROLS



MALLORY Type "MR" Junior Controls

Ultra compact controls are similar to the types UM and TM junior controls listed at left except that they feature standard shafts, 3" long, milled the entire length and furnished with knob adapters (for spring type knobs). All are rated conservatively at 1/2 watt.

No.	Type	Ohms	No.	Type	Ohms	No.	Type	Ohms
C6900	MR14	5M(4A)	C6909	MR33	50M(1)	C6918	MR44	250M(1)
C6901	MR18	10M(1)	C6910	MR34	50M(2)	C6919	MR45	250M(2)
C6902	MR19	10M(2)	C6911	MR35	50M(4)	C6920	MR48	500M(1)
C6903	MR20	10M(4)	C6912	MR36	75M(1)	C6921	MR50	500M(4)
C6904	MR21	15M(1)	C6913	MR37	75M(2)	C6922	MR51	750M(1)
C6905	MR22	15M(2)	C6914	MR39	100M(1)	C6923	MR53	1 Meg.(1)
C6906	MR24	20M(1)	C6915	MR40	100M(2)	C6924	MR55	2 Meg.(1)
C6907	MR28	25M(2)	C6916	MR41	100M(4)	C6925	MR57	3 Meg.(1)
C6908	MR29	25M(4)	C6917	MR42	150M(1)			

Type MR Controls, Any Size, Each **73¢**

Junior Controls With Fixed Knurled Shafts

Similar to type "MR" controls above, but have 3" universal knurled shaft for replacing original units of this type.

Stock No.	Type	Ohms & Taper	Stock No.	Type	Ohms & Taper
C6637	MK-400	250M(1)	C6639	MK-402	1 Meg.(1)
C6638	MK-401	500M(1)	C6640	MK-403	2 Meg.(1)

Type MK Controls, Your Cost Each, Any Type. **73¢**

Type MRT Midget Controls with Single Tap



Midget controls with single tap and fixed shaft for use in home radio receiver applications. Easy-to-cut channel shaft and insert fits all types knobs. Nuts, washer and ground terminal furnished. 1 1/2" dia. Switches listed below are easily attached.

No.	Type	Ohms	Tap	No.	Type	Ohms	Tap
C6762	MRT420	250M	50M	C6772	MRT443	1 Meg.	450M
C6763	MRT425	350M	70M	C6773	MRT460	1 Meg.	500M
C6764	MRT428	500M	5M	C6774	MRT445	2 Meg.	5M
C6765	MRT426	500M	15M	C6775	MRT446	2 Meg.	15M
C6766	MRT427	500M	100M	C6776	MRT447	2 Meg.	60M
C6767	MRT430	500M	150M	C6777	MRT450	2 Meg.	125M
C6768	MRT431	500M	225M	C6778	MRT448	2 Meg.	250M
C6769	MRT436	1 Meg.	125M	C6779	MRT454	2 Meg.	400M
C6770	MRT440	1 Meg.	200M	C6780	MRT449	2 Meg.	600M
C6771	MRT438	1 Meg.	300M	C6781	MRT451	2 Meg.	900M

Your Cost, Any Above. **\$1.09**

MALLORY Attachable Switches

Fit all "UM," "TM," "MR" & "MRT" Junior controls listed on this page.

- C6968—Single Pole, Single Throw. Each. **35¢**
- C6969—Double Pole, Single Throw
- C6970—Single Pole, Double Throw
- C6972—Four Pole, Single Throw (Shorting Type) Each. **44¢**

MALLORY-YAXLEY Encyclopedia, 5th Edition

Latest, biggest, most valuable issue. Contains all the essential service information on all prewar receivers, including all the makes and models listed in former MYE's plus an additional 4000 sets. A 25% increase in the number of new listings, makes it the largest publication ever printed containing complete, accurate replacement information on all major radio components. Incorporates all references up to and including Riders Volume XIV. **\$1.25**
C19786—Your Cost

CENTRALAB FADERS



Straight Fader

Use with high impedance input devices, dial pickups, mikes, etc. Provide smooth quiet fading from one source to another. Each tapped at center.



"Delta-T" Pad

Dual control maintaining constant impedance to both sides. For sound amplifiers, recorders, etc.

Stock No.	Resistance	Each Side c.t.	Your Cost
C9004	500M		\$1.18
C9005	1 Meg.		

Gain Control

Like above but without center tap.

No.	Resistance	Each	No.	Impedance	Each
C9000	250M	\$1.03	C9006	50 ohms	\$2.06
C9001	500M		C9007	200 ohms	
C9002	1 Meg.		C9008	500 ohms	
C9003	2 Meg.				

IRC VOLUME CONTROLS

Clutch Type DC Controls



Practical for auto radio use and other applications. Have friction clutch drive-arm equipped with a special fixed shaft for use where either slotted or tongued type shaft required. Instructions tell how to cut shaft for either applications. Switches cannot be used with friction clutch controls. Dimensions: $1\frac{1}{2} \times 1\frac{1}{4}$.

Stock No.	Type	Ohms	Price
C7757	DC13-130	250,000	Each \$1.09
C7759	DC13-133	500,000	
C7761	DC13-137	1.0 Meg.	
C7763	DC13-139	2.0 Meg.	
C7763	DC13-139	2.0 Meg.	

TAPPED CONTROLS

Stock No.	Type	No.	Tap	Ohms
C7758	DC18-130X	50M		250M
C7760	DC13-133X†	125M		500M
C7762	DC13-137X	250M		1.0 Meg.
C7764	DC13-139X	500M		2.0 Meg.

Any type above, each **\$1.09**

IRC Volume Control Guide

136-page replacement manual. Includes mfg. part numbers, Riders schematic reference and special shaft requirements. Free with order of 3 controls. **25¢**

TAP-IN SHAFTS FOR TYPE D CONTROLS

TYPE "A" SUPPLIED WITH "D" CONTROLS

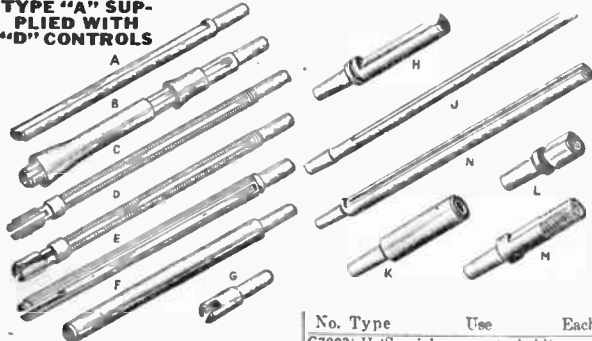

No.	Type	Use	Price
C7799	B	For Auto Radio Controls	26c
C7737	C	Knurled—For Push-on Knobs	Each 18c
C7738	D	Unknurled—For Push-on Knobs	
C7800	E	One Piece Split Knurled.	Each 18c
C7801	F	$\frac{1}{8}$ " Dia. Full Round 3" Long.	
C7802	G	$\frac{1}{8}$ " Long Slotted with Axial Hole	

No.	Type	Use	Each
C7803	H	Special groove to hold corner of dial plate.	18c
C7805	J	$\frac{1}{8}$ " Diam. with .105" flat. For Zenith Sets.	
C7806	K	Has 2 concentric holes for Motorola Sets.	
C7740	L	Has groove and threaded hole in end.	
C7769	N	Universal, $\frac{1}{8}$ " dia., fluted and slotted.	
C7768	M	Flatted, with threaded end and tapped hole.	

IRC Handy Control and Parts Cabinet



A sturdy, all-metal constructed, attractive 3 color finish. IRC Volume Control Cabinet is included FREE with a special assortment of popular sizes of Type D Controls, 5 Shafts and 6 Switches that will enable you to handle up to 80% of your Volume Control Replacements. Cabinet measures $14\frac{1}{2} \times 7\frac{1}{2} \times 4\frac{1}{4}$ ". Accommodates 20 controls, has 3 handy drawers for switches, tap-in shafts and other small parts. Control assortment includes one type DC and 17 type D Volume Controls. (Sizes indicated in stock lists upper right by type.) You pay only for Controls, Shafts and Switches. Cabinet is FREE.

C7739—Your Cost Complete.....\$18.17

THE "CENTURY" LINE— Universal Type D Controls



Compact all-purpose controls for miscellaneous service needs. Each D control accommodates any of the 13 Tap-in Shafts shown in adjoining column which greatly increases their utility. Shaft flats may be located in any position. A Double Flatted A shaft is included with each D Control, which accommodates popular push on knobs requiring either $\frac{1}{8}$ " or $\frac{1}{16}$ " flats and all set screw knobs without filing or use of inserts. Controls measure $1\frac{1}{4}$ " dia. x $1\frac{1}{2}$ " thick.

No.	Type	Use	Ohms	No.	Type	Use	Ohms
C7706	D11-103	A	500	C7728	D14-123*	D	50000
C7707	D11-108	A	1000	C7729	D13-125	C	75000
C7708	D11-110	A	2000	C7730	D14-125*	D	75000
C7724	D11-112	A	3000	C7716	D11-128†	A	100000
C7709	D11-113	A	4000	C7785	D13-128†	C	100000
C7779	D11-114	A	5000	C7717	D11-129	A	200000
C7710	D13-114	C	5000	C7718	D14-129*	D	200000
C7850	D14-114*	D	5000	C7731	D11-130	A	250000
C7725	D11-115	A	7500	C7786	D13-130†	C	250000
C7780	D11-116*†	A	10000	C7719	D14-130*	D	250000
C7711	D13-116	C	10000	C7787	D13-132	C	350000
C7781	D14-116*†	D	10000	C7732	D11-133†	A	500000
C7782	D16-116*	F	10000	C7788	D13-133†	C	500000
C7726	D11-118*	D	15000	C7720	D14-133	D	500000
C7783	D16-118*	F	15000	C7852	D11-137	A	1.0 Meg.
C7712	D16-119*†	F	20000	C7789	D13-137†	C	1.0 Meg.
C7713	D11-120	A	25000	C7705	D14-137	D	1.0 Meg.
C7727	D14-120*	D	25000	C7790	D13-139†	C	2.0 Meg.
C7714	D16-120	F	25000	C7733	D13-140	C	3.0 Meg.
C7715	D11-123†	A	50000	C7721	D11-141	A	5.0 Meg.
C7784	D13-123†	C	50000	C7723	D11-143	A	10.0 Meg.

Your Cost Each, Any Type Above

73¢

D Tapped Controls

Similar in construction to the above single controls but with tap for replacement of original control having this feature. Type A Tap-in Shaft included with each control.

Stock No.	Type	Use	Tap	Ohms
C7863	D18-117X	H	3M	13M
C7864	D18-122X	H	6M	30M
C7865	D18-123XX	Sp	7M	44M
C7736	D13-130X*	Sp	125M	250M
C7866	D17-130X	Sp	25M	250M
C7791	D18-130X	H	60M	250M
C7867	D18-130XX	Sp	60M	250M
C7868	D17-132X	Sp	35M	350M
C7792	D18-132X	H	75M	350M
C7793	D13-133X*	H	125M	500M
C7869	D17-133X	Sp	25M	500M
C7843	D18-133X	Sp	50M	500M
C7870	D18-133XX	Sp	100M	500M
C7871	D19-133X	Sp	25M	500M
C7794	D13-137X*	H	250M	1.0 Meg.
C7853	D17-137X	Sp	35M	1.0 Meg.
C7872	D17-137XX	Sp	50M	1.0 Meg.
C7735	D18-137X	Sp	100M	1.0 Meg.
C7873	D18-137XX	Sp	250M	1.0 Meg.
C7844	D19-137X	Sp	100M	1.0 Meg.
C7854	DVC-539X†	Sp	500M	1.0 Meg.
C7795	D13-139X†	H	500M	2.0 Meg.
C7874	D13-139XX	Sp	500M	2.0 Meg.
C7875	D15-139X	Sp	5M	2.0 Meg.
C7855	D17-139X	Sp	150M	2.0 Meg.
C7734	D18-139X	Sp	1.0 Meg.	2.0 Meg.
C7856	D18-139XX	Sp	250M	2.0 Meg.
C7857	D19-139X	Sp	50M	2.0 Meg.

Any type above, less switch each **\$1.09**
 †Special control for use as a fader.
 ‡Included in control cabinet.
 *Includes 270 ohm $\frac{1}{2}$ watt resistor.

Popular DS Types

These sixteen controls have been the most frequently called for. Furnished with fixed shafts for convenient, easy use. Dimensions: $1\frac{1}{2} \times 1\frac{1}{2}$ ". Uses '40' series switches.

Stock No.	Type	No.	Use	Ohms	Price
C9108	DS11-116	A		10M	Less Switch Each 73c
C9109	DS14-116*	D		10M	
C9114	DS14-120*	D		25M	
C9117	DS11-123	A		50M	
C9121	DS11-128	A		100M	
C9122	DS13-128	C		100M	
C7858	DS11-130	A		250M	
C9125	DS13-130	C		250M	
C9127	DS13-133	C		500M	
C9129	DS13-137	C		1.0 Meg.	
C9131	DS13-139	C		2.0 Meg.	

TAPPED CONTROLS

Stock No.	Type	No.	Use	Tap	Ohms
C9145	DS13-130X	SP		125M	250M
C7809	DS18-130X	H		60M	250M
C9128	DS13-133X	H		125M	500M
C9130	DS13-137X	H		250M	1.0 Meg.
C9147	DS13-139X	H		500M	2.0 Meg.

Any type above, less switch, each **\$1.09**
 *Includes 270 ohm $\frac{1}{2}$ watt resistor.

IRC SWITCHES FOR USE WITH D AND DS CONTROLS

Stock No.	Type	IRC No.	Price
C7796	SPST	41	35c
C7797	DPST	42	44c
C7798	SPDT	43	44c

IRC Control Taper Code

- A—Uniform (Pot. or Rho.)
- C—Audio Grid or Ant. Shunt
- D—Grid Bias
- F—Ant. & Grid Bias 1 or 2 Tubes
- H—Audio Tapped for Bass Comp.
- Sp—For Special Applications

Type J Controls for Special Applications

For a wide variety of sets with specific requirements, these controls are extremely useful. Play safe, stock at least one of each.

Stock No.	Type	Resistance	Price
C7859	DJ 4	2.0 Meg./1.0 Meg.	\$2.20
C7860	DJ 5	2.0 Meg./1.0 Meg.	2.20
C9169	J-15	32,000 Ohms	1.09
C9190	J-107	10,000/50,000 Ohms	1.82
C9195	J-127	3800/3800 Ohms	1.82
C9460	J-296	225,000/5,000 Ohms	1.82
C9460	J-77	350,000 Ohms	1.09
C9149	J-823	150,000/250,000 Ohms	1.82
C7862	J-843	350,000 Ohms	1.09

IRC "Junior" Control Cabinet



Hot number controls with switches and additional shafts plus a sturdy cabinet. You pay only for the merchandise.

Controls	Switches
5—D13-133	3—No. 41
1—D13-137	1—No. 42
1—D13-139	Shafts
1—D13-133X	9—type A
1—D13-137X	3—type E
	1—type H

C7698—Your Cost.....\$9.53

CENTRALAB Volume Controls

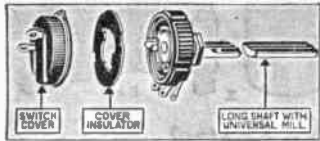

Standard Radiohms
 Noted for their long noiseless life these famous controls employ a patented non-wearing contact arrangement. A highly polished metal band is pressed into contact with the resistance strip by the rotating arm. Contact between the arm

and the band is by means of an oil-treated wood button that is absolutely noiseless and perfectly smooth in operation. Control dimensions: Diameter—1 1/4"; Depth—5/8"; Shaft length—2 1/2"; Diameter—1/4"; Bushing diameter—3/8". Flat milled shaft. Tapers follow:

- S—Voltage Divider (uniform)
- A—Antenna Shunt
- A1—Antenna Shunt & "C" Bias for 1 Tube
- A2—Ant. Sh. & "C" Bias 2 Tubes
- C—"C" Bias
- T—Tone Control
- PT—Audio Grid or Tone Control
- GT—Series in R.F. Plate

No.	CRL	Ohms	No.	CRL	Ohms	No.	CRL	Ohms
C8876	A-100	500U	C8873	A-112	15,000A	C8880	A-123	100,000GT
C8865	A-101	1000U	C8931	A-113	15,000A1	C8697	A-124	150,000GT
C8859	A-102	2000U	C8877	A-114	20,000A	C8878	A-125	200,000GT
C8866	A-103	3000U	C8869	A-115	25,000U	C8694	A-126	200,000C
C8867	A-104	4000U	C9032	A-116	25,000C	C8879	A-127	250,000GT
C8868	A-105	5000U	C8860	A-117	25,000C	C8864	A-128	500,000U
C8842	A-106	5000S	C8861	A-118	50,000U	C8841	A-129	500,000P
C8907	A-107	7500U	C8875	A-119	50,000T	C8863	A-130	500,000GT
C8872	A-108	10,000A	C9033	A-120	75,000T	C8908	A-131	750,000GT
C8871	A-109	10,000A1	C8840	A-121	75,000C	C8874	A-132	1 Meg. GT
C8843	A-110	10,000A2	C8862	A-122	100,000U	C8890	A-133	2 Meg. GT
C8858	A-111	10,000S				C8696	A-134	3 Meg. GT

Your Cost Each—Any Type Listed Above..... 73¢

TAPPED RADIOHMS (For Tone Compensation) (Composition Element)

C8891—AT-135	250,000 ohms GT	} Your Cost Each..... \$1.09
C8881—AT-136	500,000 ohms GT	
C8882—AT-137	1 Megohm GT	
C8909—AT-138	2 Megohms GT	

WIRE WOUND RADIOHMS

C8959	V-104	6	C8683	V-123	200	C8687	V-131	2000
C8961	V-108	10	C8684	V-126	400	C8765	V-133	3000
C8681	V-116	50	C8685	V-127	500	C8804	V-135	5000
C8682	V-121	100	C8686	V-129	1000	C8766	V-137	10,000

Your Cost Each, Any Type Listed Above..... 73¢

Twin Replacement RADIOHMS

Most popular twin controls for general replacement.

Stock No.	CRL No.	Front Ohms	Rear Ohms	Your Cost Each.....
C8312	C-100	10,000	25,000	\$1.82
C8913	C-101	10,000	50,000	
C8758	C-102	100,000	100,000	
C8768	C-103	250,000	250,000	
C8787	C-104	500,000	500,000	

SWITCH COVERPLATES For Standard Radiohms

C8665	S.P.S.T.	35¢	C8669	4 Point	} 44¢
C8666	S.P.D.T.	44¢	C8670	*S.P.D.T.	
C8660	D.P.S.T.		C8661	†S.P.S.T.	

*—Open at clockwise position. †—With dummy lug.

CENTRALAB Midget Radiohms

Small diameter controls for use in auto radio sets or in midget radios. Molded bakelite cases. All potentiometer type, with insulated terminals. Depth, less switch, 3/4". 2 1/2" shaft milled entire length. Separate switches easy to install. Same taper symbols as shown with standard Radiohms above. CRL type numbers given below are less switch.

No.	CRL	Ohms	No.	CRL	Ohms	No.	CRL	Ohms
C8187	N106	5000U	C8281	N112	20,000A	C8192	N102	250,000GT
C8190	N107	10,000A	C8217	N113	25,000U	C8273	N118	500,000U
C8188	N100	10,000A1	C8191	N101	25,000A	C8193	N103	500,000GT
C8189	N108	10,000A2	C8218	N114	50,000U	C8194	N104	1 Meg. GT
C8278	N109	10,000S	C8219	N115	50,000T	C8169	N155	2 Meg. GT
C8279	N110	15,000A1	C8220	N116	100,000U	C8166	N177	5 Meg. U
C8280	N111	15,000A2	C8272	N117	100,000GT	C8170	N178	10 Meg. U

Any Type Listed Above (Less Switch) Each..... 73¢

Tapped Midget Radiohms			Midget Switch Plates		
CRL	Ohms	Each	Stock No.	Type	Each
C8274	NT119	250,000	C8195	S.P.S.T.	35¢
C8275	NT120	500,000	C8196	S.P.D.T.	} 44¢
C8276	NT121	1 Meg.	C8197	D.P.S.T.	
C8277	NT122	2 Meg.	C8198	4 Point	
			C8199	*S.P.S.T.	*—With dummy lug.

CRL Split Knurl Midget Radiohms

For 1938-39-40-41 radios using split-knurl shafts where the knobs will not fit any other type of shaft. Shafts 2 3/8" long.

No.	CRL	Ohms	No.	CRL	Ohms	Each
C8285	NK-139	250M	C8289	NK-143	500M*	\$1.09
C8286	NK-140	500M	C8291	NK-144	1 Meg.*	
C8287	NK-141	1 Meg.			*—Tapped controls.	
C8288	NK-142	2 Meg.				

Nationally-known VOLUME CONTROLS

IRC Type "W" Wire Wound Controls

Diameter 1 1/4". Rated 2-watts. 3" shaft. Less switch, but switch covers listed below can be easily added. Uniform taper. Ideal for use where space is limited. Shield dust cover supplied.

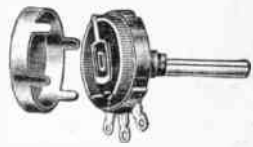

Stock No.	IRC No.	Ohms	Stock No.	IRC No.	Ohms	Stock No.	IRC No.	Ohms
C7810	W-6	6	C7818	W-50	50	C7826	W-750	750
C7811	W-8	8	C7819	W-60	60	C7827	W-1000	1000
C7812	W-10	10	C7820	W-75	75	C7828	W-2000	2000
C7813	W-15	15	C7821	W-100	100	C7829	W-3000	3000
C7814	W-20	20	C7822	W-200	200	C7830	W-4000	4000
C7815	W-25	25	C7823	W-300	300	C7831	W-5000	5000
C7816	W-30	30	C7824	W-400	400	C7832	W-7500	7500
C7817	W-40	40	C7825	W-500	500	C7833	W-10000	10000

Your Cost Each, Any Above Type..... 73¢

Switches for "W" Controls

SPST	DPST	SPDT
C7834—Ea..... 35¢	C7835—Ea..... 44¢	C7836—Ea..... 44¢

CLAROSTAT Wirewound Controls

Wirewound controls with alloy wire precisely wound on thin bakelite strip. Perfect sliding contact. 1/4" shaft, 1 1/2" long.



- * —Rheostat L—Untuned Antenna
- S—Standard Pot. (Uniform) V—"C" Bias Control
- W—Screen Grid; Phono Control
- U—Antenna & "C" Bias (1 Tube)

No.	Ohms	No.	Ohms	No.	Ohms	No.	Ohms
C7048*	1	C7058*	40	C7092	1000S	C7080	7500U
C7049*	2	C7059	50S	C7090	2000S	C7079	7500V
C7050*	3	C7060*	60	C7089	2000L	C7078	10000V
C7051*	4	C7061*	75	C7088	2000V	C7075	10000V
C7052*	6	C7098	100S	C7087	3000S	C7074	10000W
C7053*	10	C7097	200S	C7086	3000U	C7073	15000S
C7054*	15	C7096	300S	C7047	4000S	C7072	15000U
C7055*	20	C7095	400S	C7084	5000S	C7070	20000S
C7056*	25	C7094	500S	C7083	5000U		
C7057*	30	C7093	750S	C7082	5000V		

Any Above Type—Your Cost Each..... 73¢

Any Above Type—Your Cost Each..... 94¢

Any Above Type—Your Cost Each..... \$2.06

RELIANCE Volume Controls

Guaranteed Quality at Low Prices

Full length shaft. Standard 3/4" bushing. Switches are affixed, SPST, Less Switch With Switch Ohms Taper

C8112	C8123	25,000	Linear, for voltage-divider circuits
C8115	C8119	50,000	Linear, for voltage-divider circuits
C8114	C8129	100,000	Linear, for voltage-divider circuits
C8116	C8120	250,000	Linear, for voltage-divider circuits
C8117	C8121	500,000	Linear, for voltage-divider circuits
C8113	C8126	500,000	For audio or antenna shunt circuits
C8118	C8122	1 megohm	Linear, for voltage-divider circuits
C8105	C8127	1 megohm	For audio or antenna shunt circuits
C8111	C8133	2 megohm	For audio or antenna shunt circuits

Less Switch, Your Cost..... 34¢

With Switch, Your Cost..... 44¢

Potentiometer with Switch

160 ohm 4 watt potentiometer with insulated rotor and switch. Straight taper. 3/8" threaded bushing with 1/4" shaft extending 3/4" from bushing. Less mtg. nut. Molded bakelite case. Snap-on switch plate.

C8142
Your Cost..... 29¢

SPST Tone Control Switch

SPST rotary tone switch, with rotor grounded to shaft. Standard 3/4" bushing with 1/4" shaft to accommodate standard knob. Shaft length 1 1/4".

C1259
Your Cost..... 8¢

Thordarson

Replacement Transformers

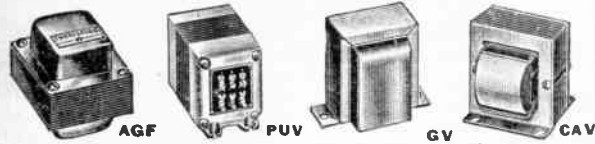

Vibrator Power Transformers					
No.	Type	Primary	Secondary	Mtg. Type	Cost
C2093	T22R20	6-8V DC	250V DC 50 ma	CAV	\$3.22
C2094	T22R22	6-8V DC	325V DC 75 ma	CAV	3.82
C2095	T22R24	6-8V DC 117V AC	325V DC 135 ma& 6.3V CT 4.75 A	GGV	7.06

Audio Interstage Transformers					
Stock No.	Type No.	Mtg. Type	Application	Turns Ratio	Your Cost
C2008	T20A16	BAH	Sgl. pl. to sgl. or PP grids	1:2	\$1.41
C2009	T20A17	FGV	Sgl. pl. to sgl. or PP grids	1:2	1.53
C2010	T20A19	BAH	Sgl. or PP pl. to sgl. or PP grids	1:3	1.53
C2011	T20A22	BAH	Sgl. pl. to sgl. or PP grids	1:3	1.88
C2012	T20A23	FGV	Sgl. pl. to sgl. or PP grids	1:3	2.06
C2013	T20A24	FGV	PP plates to PP grids	1:3	2.41
C2014	T20A25*	RTV	Sgl. or PP pl. to sgl. or PP grids	1:1.41	4.41

*Fully potted; hum-bucking coil and core.

Universal Chokes

Newly designed Universal Chokes replace swinging or smoothing types. Voltage regulation not affected. Provides more inductance in filter throughout current range, decreasing ripple voltage.

Stock No.	Type No.	Inductance	Ily. Rated	Current MA. Rated	DC Ohms	Mtg. Type	Your Cost
C2015	T20C50	350	75	5	25	5300 BAH	\$1.76
C2016	T20C51	35	15	25	1850	BAH	1.06
C2017	T20C52	8	4	40	65	450 BAH	1.06
C2018	T20C53	12	8	80	100	375 BAH	1.47
C2019	T20C54	8	4	150	200	145 GGV	2.50
C2020	T20C55	6	2	200	300	75 GGV	2.79
C2021	T20C56	7	4	300	375	60 GGV	4.56
C2022	T20C57	10	6	500	600	65 PUV	17.64
C2023	T20C58*	.75	.75	0	10	30 BAH	1.18

Driver Transformers

Stock No.	Type No.	Input Tubes	Output Tubes	Ratio	Pri. MA	Mtg. Type	Your Cost
C2028	T20D75	1-30, 1-49, 1-6C5, 1H4 (single pl.)	1J6, 19, 2-30, 2-49	2.4:1	3 BAH	MA Type	\$1.32
C2029	T20D76	1-6N7, 6A6, 53, 1-76 (sgl. pl.)	1-6N7, 6A6, 53	5.2:1	7 BAH		1.47
C2030	T20D77	1-89, 6F6, triode 1-6C5 (sgl. pl.)	79, 2-46, 59	2.5:1	30 FGV		2.20
C2031	T20D78	2-6F6, Triode 2-6A6, 53	2-6F6 (class AB ₂) 2-6N7 (class B)	4:1	40 GGV		2.94
C2032	T20D79	2-6N7 (sgl. or PP pri.)	2-6N7 (PP class B grids)	5.2:1	30 FGV		2.50
C2033	T20D80	2-2A3, 45, 6L6 (PP pri.)	203A, T20, 805, 100TH, T55 (cl. B)	3.2:1	40 GGV		3.47
C2034	T20D81	PP 845, etc. (PP pri.)	PP 805, 833, etc. (PP Cl. B grids)	5:1	50 GGV		4.41
C2035	T20D82	2-2A3, 45, 6L6 (PP pri.)	PP 805, 833, etc. (PP Cl. B grids)	5:1, 4:1	60 GGV		4.41
C2036	T20D83	Pri. 500 ohm line 1:1, 1:1.25, 1:1.75, 1:2, 1:2.5, 1:2.75, 1:3.	Class B Grids Ratio*		PUV		14.11

Universal Replacement Power Transformers

Replacements for amplifiers, receivers. Adjustable mounting brackets. All leads RMA color-coded. 117V 50-60 cycle input. Mtg. type AGF. *Mtg. type GG.

Stock No.	Type No.	Plate V	MA	Rect. Fila.	Fila. No. 2	Fila. No. 3	Your Cost
C2081	T22R00	250-0-250	40	5V-2A	6.3VCT-2A		\$3.09
C2083	T22R01	275-0-275	50	5V-2A	6.3VCT-2.5A		3.12
C2084	T22R02	300-0-300	70	5V-2A	6.3VCT-3A		3.97
C2085	T22R04	300-0-300	90	5V-2A	6.3VCT-3.5A		4.41
C2086	T22R05	300-0-300	120	5V-3A	6.3VCT-5A		4.70
C2087	T22R06	325-0-325	150	5V-3A	6.3VCT-5A		5.59
C2088	T22R07	350-0-350	200	5V-3A	6.3VCT-6A		6.35
C2089	T22R08	250-0-250	40	5V-2A	2.5VCT-4A		3.09
C2090	T22R09	275-0-275	50	5V-2A	2.5VCT-4.5A		3.67
C2091	T22R10	325-0-325	85	5V-2A	2.5VCT-9A	2.5VCT-3.5A	4.70
C2092	T22R11	325-0-325	120	5V-2A	2.5VCT-12.5A	2.5VCT-5A	5.59
C2093	T22R13*	275-0-275	50	5V-2A	6.3VCT-2.5A		4.26
C2097	T22R13*	360-0-360	80	5V-2A	6.3VCT-2.5A		4.56
C2098	T22R13*	350-0-350	110	5V-2A	6.3VCT-3A		5.14
C2099	T22R13*	375-0-375	160	5V-3A	6.3VCT-5A		6.17
C2100	T22R13*	385-0-385	225	5V-3A	6.3VCT-5A		7.94
C2101	T22R13*	400-0-400	340	5V-6A	6.3VCT-7A		8.82

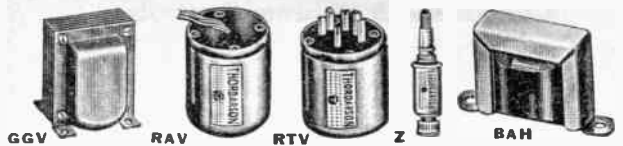

Dual Tone Control

An effective tone compensating network for sound systems. Treble and bass frequencies attenuated or accentuated independently. For smooth control over wide range of audio frequencies. T20C74 Tone Control Choke with Hum-bucking Coil and Core. DC ohms 220. Test volts 500. Mtg. Type RAV.

C2027—
Your Cost **\$1.91**
R1068-X Dual Tone Control Potentiometer for above circuit.
C2149—
Your Cost **\$2.44**

Feedback Control Transformer

T20A26 is the control element in a variable audio inverse feedback system, basis of compressor-expander circuit. Variable gain is produced by automatically controlling inverse feedback voltage. Superior to DC grid bias control, response faster, harmonic distortion does not rise. Transformer comes with complete details of 10 Watt hi fidelity amplifier incorporating above circuit. Mtg. type RTV.

C2026—
Your Cost **\$4.41**

Microphone Cable Transformers

Permits rapid change from low impedance to high impedance microphone or any amplifier. Frequency response flat from 30 to 15000 cycles. Mtg. Type Z.

Stock No.	Type No.	Primary	Sec.	Turns Ratio	Your Cost
C2006	T20A40	30-60	50,000	1:31.6	\$11.76
C2007	T20A41	200-250	50,000	1:14.2	11.76

Audio Input Transformers

Stock No.	Type No.	Mtg. Type	Application	Turns Ratio	Your Cost
C2000	T20A00	BAH	Line or mic. to single or PP grids	1:10	\$1.41
C2001	T20A01	FGV	Line or mic. to single or PP grids	1:20	2.00
C2002	T20A02	FGV	Line or mic. to PP grids	1:20	2.06
C2005	T20A05	RTV	Line to mic. grid mic. to single or PP grids	1:10	5.88
C2004	T20A04	BAH	V.C. or low imp. mic. to grid	1:80	1.23

Transceiver Transformer

Stock No.	Type No.	Mtg. Type	Application	Turns Ratio	Your Cost
C2003	T20A03	BAH	Single pl. to grid Line or mic. to grid	1:3.25 1:35	\$1.76

Output Transformers

Low Level Output Transformers (BAH)

Stock No.	Type No.	Application	Pri. Imp.	Sec. Imp.	Power Output	Your Cost
C2103	T22S45	Sgl Pl to VC	1500 to 3000	3.2 to 4	3	\$0.97
C2104	T22S46		3000 to 6000	3.2 to 4	3	1.00
C2105	T22S47		6000 to 12000CT	3.2 to 4	3	1.32
C2106	T22S48		12000 to 25000CT	3.2 to 4	3	1.41
C2107	T22S55	Sgl & PP	8000 or 10000CT		8	1.76
C2108	T22S58	Pl to VC	5000 or 7000CT	3.2 to 4	8	1.76
C2109	T22S60		2500 or 4000CT	6 to 8	8	2.00

Special Duty Hi-Level Output Transformers (GGV)

Stock No.	Type No.	Application	Pri. Imp.	Sec. Imp.	Power Output	Your Cost
C2111	T22S64		10000CT		25	\$3.67
C2112	T22S66		8000CT	3.2 to 4	25	3.67
C2113	T22S68	Sgl & PP Pl	6500CT	6 to 8-	25	3.82
C2114	T22S70	to Line & VC	5000CT	15-250-500	25	4.12
C2115	T22S72		3000CT		25	4.12
C2118	T22S78		3300CT		60	5.59

Universal Replacement to Multiple Voice Coil (BAH)

Stock No.	Type No.	Application	Pri. Imp.	Sec. Imp.	Power Output	Your Cost
C2116	T22S74	Sgl or PP Pl to VC	14000-10000-8000	1 to 30	25	\$3.09
			6600-5000-3000			
			2500CT			
C2110	T22S62	Sgl Pl to VC	4000-3000-2500	1 to 30	8	2.18
			2000-1500			
C2124	T22S86	Sgl Pl or PP Pl to VC	14000CT-8000CT	3.2 to 4	3	1.62
C2125	T22S87		3500-2000	6 to 8	6	1.76
C2126	T22S88			8	1.91	

Universal and Special Duty

Stock No.	Type No.	Application	Pri. Imp.	Sec. Imp.	Power Output	Your Cost
C2117	T22S76	Univ. or PP Tubes to Line	14000-12000-10000-8000-5000-3000CT	500 to 600	25	\$3.23
C2127	T22S90	Sgl or PP Pl (FGV)	20000CT	125-200-500 to 600CT	3	2.65
C2128	T22S92	Sgl or PP Pl Hum-bucking Coil and Core	20000CT	125-200-500 to 600CT	3	5.88
Matching Line or Lines to Voice Coil (BAH)						
C2119	T22S80	Sgl Line to VC	500 to 600		8	\$2.35
C2120	T22S82	Multiple Lines to VC			25	4.70
C2121	T22S83	Lines to VC	2000-1500-	3.2 to 4	15	3.23
C2122	T22S84		1000-500	6 to 8-15	5	2.29
C2123	T22S85				3	2.00

UNIVERSAL OUTPUT TRANSFORMERS

(All have secondaries adjustable from 1 to 30 ohms)

No.	Type	Primary Ohms	Mtg.	Ctrs.	Lbs.	Each
C1675	A-3856	All for Single	Q	2 1/2"	1	\$1.32
C1637	A-3823	or P. P. plates,	J	2 1/2"	1	1.41
C1671	A-3850	4000, 7000, 8000,	J	2 1/2"	1	1.50
C1673	A-3852	10M, 14M CT	J	2 1/2"	1	1.82
C1678	A-3890		TD	2 1/2"	2	2.79
C1670	A-3849*	1500, 2000, 4000, 5000, 7000, 10,000	Q	2 1/2"	1	1.32
C1666	A-3830†	3000, 5000, 6600, 7000, 8000, 10,000 CT	J	2 1/2"	3	2.50

*For battery radios. †Designed for tubes with large output.

LINE TO VOICE COIL

Stock No.	Type	Impedance	Mtg.	Watts	Size	Wt.	Each
C1635	A7947	Pri. 2000, 1500, 500- Sec. 6 ohms	Q	8	1 1/2" x 2 1/2" x 1 1/2"	1 lb.	\$1.47
C1636	A7949	Pri. 2000, 1500, 500- Sec. 6-8 ohms	J	12	2 1/2" x 2 1/2" x 1 1/2"	1 lb.	1.76

CRYSTAL RECORDER OUTPUT TRANSFORMERS

Type A mtg. Shpg. wt. 5 W.—1 lb.; 10 W.—1 1/2 lbs.

Stock No.	Output Tubes	Impedance Pri.	Sec.	Max. Watt	Dimensions H x W x D	Mtg. Ctrs.	Wt. Lbs.	Your Cost
C1591	Single	7M	70M or 4-6	5	1 1/2" x 3 1/2" x 1 1/2"	2 1/2"	1	\$2.15
C1592	Single	7M	70M or 4-6	10	1 1/2" x 3 1/2" x 2 1/2"	3 1/2"	1	2.35
C1593	P.P.	10M	70M or 4-6	5	1 1/2" x 3 1/2" x 1 1/2"	2 1/2"	1	2.20
C1594	P.P.	10M	70M or 4-6	10	1 1/2" x 3 1/2" x 2 1/2"	3 1/2"	1	2.59

REPLACEMENT DRIVER TRANSFORMERS

Stock No.	Type No.	Impedance Pri.	Sec.	Ratio 1/2 Sec.	Mtg. Type	Ctrs.	Wt. Lbs.	Your Cost
C1684	A-4712*	20M	2.2M	3:1	A	2 1/2"	1	\$1.47
C1685	A-4713	10M	2.5M	2:1	A	2 1/2"	1	1.32
C1688	A-4723	10M	1.1M	3:1	A	2 1/2"	1	1.32
C1687	A-4722	10M	10M	1:1	TD	2 1/2"	2	2.76
C1682	A-4401	10M	1.6M	2.7:1	J	2 1/2"	2	2.03
C1689	A-4734	10M	1.6M	2.5:1	S	2 1/2"	2	1.73

UNIVERSAL INTERSTAGE TRANSFORMERS

Split secondaries. Primary center tapped. May be used plate to grid, p.p. input or p.p. interstage. Primary will pass 10 milliamperes DC. Shpg. wt. each, 2 lbs.

No.	Type	Core	Mtg.	H. W. D.	Centers	Each
C1630	A-4773	3 1/2" x 1"	TD	2 1/2" x 2 1/2" x 2 1/2"	2 1/2"	\$3.12
C1631	A-4774	3 1/2" x 1"	S	2 1/2" x 2 1/2" x 2 1/2"	2 1/2"	2.06
C1634	A-4775	7 1/2" x 2 1/2"	S	2 1/2" x 2 1/2" x 2 1/2"	2 1/2"	2.68

Push-Pull Inputs (1 Pl. to 2 G.)

Stock No.	Type No.	Turns Ratio	Dimensions H x W x D	Mtg. Type	Ctrs.	Wt. Lbs.	Your Cost
C1651	A-53C	3:1	1 1/2" x 2 1/2" x 1 1/2"	A	2"	1	\$1.26
C1690	A-63C	3:1	2" x 2 1/2" x 1 1/2"	A	2"	1	1.35
C1654	A-73C	3:1	2" x 3 1/2" x 1 1/2"	A	2 1/2"	1	1.76
C1691	A-4750	3:1	2 1/2" x 2 1/2" x 1 1/2"	S	2 1/2"	1	1.76
C1686	A-4719	3:1	2 1/2" x 2 1/2" x 2 1/2"	TD	2 1/2"	2	3.00
C1587	A-62C	2:1	1 1/2" x 2 1/2" x 1 1/2"	A	..	1	1.35
C1588†	A-4745	2:1	2 1/2" x 2 1/2" x 2 1/2"	TD	..	2	3.23
C1589*	A-4206	3:1	3 1/2" x 2 1/2" x 2 1/2"	C	..	3	3.73

*Split Secondary. †Has static shield.

Push-Pull Interstage (2 Pl. to 2 G.)

Stock No.	Type	Turns Ratio	Dimensions H x W x D	Mtg.	Ctrs.	Wt. Lbs.	Your Cost
C1683	A-4711	1:1	1 1/2" x 2 1/2" x 1 1/2"	A	2 1/2"	1	\$1.59
C1681*	A-4208	1.4:1	3 1/2" x 2 1/2" x 2 1/2"	C	..	2.5	3.06

*Has split secondary.

UNIVERSAL MOUNTING POWER TRANSFORMERS

★ Electrostatically Shielded ★ 5 Possible Mounting Positions
★ Primaries for 115 V. 50/60 Cycles ★ Heavy 8-Inch Flexible Leads

Stock No.	Type No.	No. of Tubes	Your Cost	Plate		Rec. Fil.		Fil. No. 1		Fil. No. 2		Mtg. Area	Wt. Lbs.
				Vlts.	M.A.	V.	A.	V.	A.	V.	A.		
C1706	P-6001	4-5	\$3.06	650	40	5	2	2.5	4	2 1/2" x 3 1/2"	4
C1712	P-6002	5-6	3.53	700	50	5	3	2.5	7 1/2	2 1/2" x 3 1/2"	4
C1713	P-6003	6-7	4.26	700	70	5	3	2.5	9	2 1/2" x 3 3/4"	4
C1714	P-6004	8-9	4.32	700	90	5	3	2.5	12.5	3 1/2" x 3 3/4"	6
C1715	P-6005	6-7	4.41	550	70	5	3	5.0	5	2.5	10.5	2 1/2" x 3 3/4"	5
C1716	P-6006	6-7	4.35	700	70	5	3	2.5	9	2.5	3.5	2 1/2" x 3 3/4"	6
C1716	P-6006	11-13	5.44	700	120	5	3	2.5	12.5	2.5	3.5	3 1/2" x 3 3/4"	6
C1717	P-6007	10-12	5.32	800	110	5	3	2.5	15	2.5	3.5	3 1/2" x 3 3/4"	7
C1735	P-6297	4-5	2.85	480	40	5	2	6.3	2	2 1/2" x 3 1/2"	4
C1720	P-6010	4-5	2.85	650	40	5	3	6.3	2	2 1/2" x 3 1/2"	4
C1721	P-6011	6-7	3.73	700	70	5	3	6.3	2.5	2 1/2" x 3 1/2"	4
C1722	P-6012	8-9	3.94	700	90	5	3	6.3	3.5	2 1/2" x 3 3/4"	6
C1723	P-6013	11-13	4.38	700	120	5	3	6.3	4.7	3 1/2" x 3 3/4"	6
C1724	P-6014	13-15	5.53	750	150	5	3	6.3	5	3 1/2" x 3 3/4"	6
C1726	P-6165	14-16	6.41	800	200	5	4	6.3	5.5	3 3/4" x 4 1/2"	7
C1731	P-6293	6-7	4.12	600	60	5	3	6.3	2.5	2.5	7.5	2 1/2" x 3 3/4"	4
C1733	P-6295	8-9	5.23	700	90	5	3	6.3-2.5	3.5	2.5	9	3 1/2" x 3 3/4"	6
C1734*	P-6234*	11-13	6.32	660	90	5	3	2.5	12	2.5-5.0	4	3 1/2" x 3 3/4"	6
C1718	P-6008	14-16	5.97	750	180	5	3	6.3	3.3	2.5	6	3 7/8" x 4 1/2"	7

*C1734—P-6234 has an additional 2.5 V. at 1.75 amp. CT Filament winding.

SPECIAL 6.3 V. TRANSFORMERS FOR SETS USING P.M. SPEAKERS

Stock No.	Type No.	No. of Tubes	Your Cost	Plate Vlts.	M.A.	Rec. Fil. V.	A.	Fil. No. 1 V.	A.	Fil. No. 2 V.	A.	Mtg. Area	Wt. Lbs.
C1785	P-6289	5-6	\$2.85	420	40	5	2	6.3	2	2 1/2" x 3 1/2"	4
C1786	P-6119	6-7	3.53	600	55	5	2	6.3	2.7	2 1/2" x 3 1/2"	4
C1787	P-6120	7-9	3.76	630	70	5	3	6.3	3.5	2 1/2" x 3 3/4"	6
C1741	P-6312	7-8	4.29	580	90	5	3	6.3	2.8	3 3/8" x 2 1/2"	6
C1743	P-6313	11-13	4.85	580	125	5	3	6.3	4.5	4 1/8" x 3 7/8"	7
C1744	P-6314	14-16	6.29	700	200	5	3	6.3	5.5	4 1/2" x 3 3/4"	8
C1745	P-6315	16-18	8.59	740	275	5	3	6.3	7.0	4 1/2" x 3 3/4"	9

STANCOR

Replacement Transformers

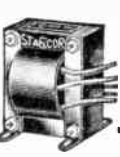

OUTPUT TRANSFORMERS

Stock No.	Type No.	Class Oper.	Tubes	Impedance in Ohms		Mx. Wts.	Mtg. No.	Your Cost
				Prim.	Secondary			
C1663	A-3822	A	S	7M, 10M	7 to 4	5	Q	\$1.12
C1669	A-3848	A	S	16,000	1, 2, 4	5	Q	1.32
C1676	A-3857	A	S	25,000	4	5	A	1.15
C1677	A-3865	A	S	1,500	2, 4, 6	5	A	1.21
C1640	A-3876	A	S	2,000	4	5	A	.88
C1645	A-3877	A	S	5,000	4	5	A	.91
C1646	A-3878	A	S	7,000	4	5	A	.91
C1648	A-3879	A	S	10,000	4	5	A	.94
C1649	A-3881	A	S	15,000	4	5	A	.94
C1647	A-2201	A	S or PP	8,000	6	10	A	1.59
C1664	A-3824	B	S	8,000	1, 2, 4	8	Q	2.09
C1665	A-3825	A	S	2,500	1, 2, 4	8	Q	1.47
C1667	A-3831	B	S or PP	10M	2, 4, 8	5	A	1.38
C1656	A-3303	A & B	S or PP	11M	4, 8, 15, 500	20	C	3.50
C1657	A-3301	A & B	S or PP	10M, 7M	4, 8, 15, 500	25	C	3.67
C1644	A-3301	A & B	PP	3,000	4, 8, 15, 500	30	C	3.94
C1672	A-3851*	AB1	PP	4,100	4, 8, 15, 250, 500	30	C	4.56
C1590	A-3855	A	S or PP	7,000	10, 2000	5	TD	2.88
C1661	A-3800	A & AB	PP	5,000	4, 8, 15, 30	30	C	4.03
C1662	A-3801	AB1	PP	6,600	250, 500	35	C	4.70

*10% Inverse Feedback Winding.

FILTER CHOKES TYPE A

Stock No.	Type No.	Henrys	Ctr. D.C.	Dimensions H x W x D	Wt. Lbs.	Your Cost
C1698	C-1706	4.5	50	300	1 1/2" x 2 1/2" x 1 1/2"	\$0.82
C1699	C-1707	7	50	550	1 1/2" x 2 1/2" x 1 1/2"	1.82
C1700	C-1708	13	65	500	1 1/2" x 2 1/2" x 1 1/2"	1.06
C1701	C-1709	8	85	250	1 1/2" x 2 1/2" x 1 1/2"	1.41
C1702	C-1710	7	150	200	2 1/2" x 2 1/2" x 1 1/2"	1.79
C1623†	C-4003	16	50	500	1 1/2" x 3 1/2" x 1 1/2"	2.09
C1624	C-4002	15	75	400	1 1/2" x 3 1/2" x 1 1/2"	1.50
C1625	C-4001	10.5	110	225	2 1/2" x 4" x 2"	1.88
C1626*	C-4034	8	30	1365	1 1/2" x 2 1/2" x 1 1/2"	2.135
C1583	C-2303	2.5	130	100	2" x 3" x 1 1/2"	1.132
C1584	C-2304	2.5	150	60	2" x	

UTC Replacement Transformers



VARITAP Universal Mount Transformers and Chokes

VARITAP audios represent the acme in replacement transformer development. The **double shells** and universal mounting brackets are finished in high lustrous black. All mounting positions incorporate long slots for maximum flexibility. All coils are well shielded, and have tropical wetproof impregnation. Shipping weight each, 3 lbs.

No.	Type	Description	Size	Ea.
C5540	R-231	1 Plate to 1 Grid. Ratio 3½:1	G	\$2.41
C5541	R-241	Plate to 2 Grids. Ratio 2:1	G	2.53
C5542	R-252	2 Plates to 2 Grids. 1.5:1 step-up for Class A triodes, 1.5:1 step-down for 6L6's, 2A3's, 2A5's, etc.	G	2.65
C5543	R-26	Driver, 1 Plate to 2 Grids, Single 42, 2A5, 6F6, 45 to AB 6L6's, 42's, 2A5's, etc.	G	2.65
C5544	R-27	15-Watt Output. All tubes to 1-30 ohm voice coils	G	2.41
C5545	R-28	35-Watt Output. All tubes to 1-30 ohm voice coils	H	3.41
C5546	R-29	Single or double button mike or line to 1 grid.	G	2.53
C5547	R-31	Filter Choke. 10 Henrys, 80 ma., 100 ohms.	G	2.06
C5548	R-32	Filter Choke. 10 Hy., 150 ma., 200 ohms.	H	2.94

Tropic Sealed Channel Frame Audios

An excellently designed series of channel frame TROPICAL WET-PROOF audios. In addition to good frequency response, coils are vacuum-pressure treated followed by the UTC MOULD SEAL process of WET PROOFING to prevent moisture absorption. All have black enamel finish, and have long insulated leads. Average shipping weight, each 2 lbs.

Audio Transformers

No.	Type	Description of Unit	Size	Each
C5514	R-33	1 Plate to 1 Grid. Ratio 4:1	B	\$1.71
C5515	R-34	1 Plate to 2 Grids. Ratio 2:1	B	1.76
C5516	R-35	Mike to 1 Grid. Ratio 17:1	B	2.17
C5517	R-56	1 Plate to 2 Grids. Ratio 2:1	D	2.17
C5518	R-57	1 Plate to 2 Grids. High Fidelity. Ratio 2½:1	F	3.41
C5519	R-36	Driver (30, 49, etc.) to Class B 19, 79, 89 Grids	B	2.17
C5520	R-37	R.F. Output. Class B19, 49, 79, 89 plates to 3500, and 5000 ohms.	B	2.29
C5521	R-58	5-Watt Universal Output. Any single tube to any voice coil from .1 to 30 ohms	A	1.76
C5522	R-38A	6-Watt Univ. Out. Any tubes to .1 to 30 ohms	A	1.76
C5523	R-59	10-Watt Univ. Out. Any tubes to .1 to 30 ohms	B	2.06
C5524	R-60	15-Watt Univ. Out. Any tubes to .1 to 30 ohms	D	2.17
C5525	R-39	10-Watt Line Matching: 250, 500, 1500 ohms to 2, 8, 15 ohm voice coil.	B	2.23
C5526	R-40	25-Watt Line Matching: 250, 500, 1500 ohms to 2, 8, 15 ohm voice coil.	C	3.23

Filter and Audio Chokes

No.	Type	Henrys	Ma.	Ohms D.C.	Size	Each
C5527	R-55	10	35	300	A	\$1.03
C5528	R-14	12	40	250	B	1.23
C5529	R-15	15	30	450	B	1.23
C5530	R-16	20	30	600	B	1.23
C5531	R-17	25	30	1000	D	1.65
C5533	R-18	10	75	250	D	1.65
C5534	R-19	15	100	450	E	2.29
C5535	R-20	8	160	100	F	2.53
C5537	R-21	5/25	160	100	F	2.53
C5538	R-22	500	5	6000	D	2.29

Mounting Dimensions of Above Units

Size A: 2½" w., 1½" d., 1½" h.	Size E: 3½" w., 1½" d., 2½" h.
Size B: 2½" w., 1½" d., 1½" h.	Size F: 4½" w., 2" d., 2½" h.
Size C: 4½" w., 2½" d., 2½" h.	Size G: 2½" w., 1½" d., 2" h.
Size D: 3½" w., 1½" d., 2" h.	Size H: 3" w., 2½" d., 2½" h.

Photo-Flash Transformers

For use with standard Amko type or Sylvania trigger type multiple flash bulbs. Circuit detail included with transformers.

PF-1 Primary for 115 v., 50/60 cyc. Secondaries for power supply delivering 2200 VDC to condenser up to 100 MFD. Compound sealed. 2½x2½x2½". Shipping weight 3 lbs.

C5414 - Your Cost \$5.88
PF-2 For portable use. Primary for 4- or 6-volt battery. Secondary for delivering 2200 VDC to condenser up to 60 mfd. Same case and weight as above.

C5415 - Your Cost \$5.88
PF-3 Trigger Transformer 15KV peak.

C5416 - Your Cost 2.65

VARITAP All-Purpose Power X'formers

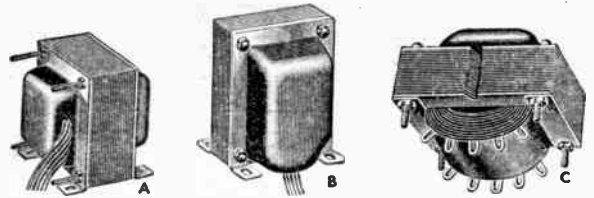

Type A units feature universal mounting. Leads brought out through single insulated opening, universal flanges supplied. Type B standard vertical shielded transformers with long insulated leads. Type C are for flush mounting and have lug terminals with windings marked. All units vacuum sealed. Black enamel finish. High voltage filament windings center-tapped. Primaries 115v., 50/60 cycles.

File No. 1 and File No. 2 provides either ONE of the voltages shown

Universal Mounting Transformers (type A)

Stock No.	Type	Plate		Rect. Fil.		Fil. No. 1		Fil. No. 2		Your Cost
		V.	Ma.	V.	A.	V.	A.	V.	A.	
C5500	R-1	650	40	5	2	6.3	2	2.5		\$3.59
C5501	R-2	700	70	5	3	6.3	2.5	2.5		4.35
C5502	R-3	700	95	5	3	6.3	4.5	2.5	9	5.29
C5503	R-4	750	120	5	4	6.3	5	2.5	15	6.29
C5504	R-5	770	180	5	4	6.3	4	6.3	5	7.64

Vertical Shielded Transformers (type B)

C5505	R-51	600	50	5	2	6.3	2	2.5		3.88
C5506	R-11	700	75	5	3	6.3	3	2.5	8	5.59
C5507	R-12	750	100	5	3	6.3	4	6.3	2	6.35
C5508	R-13	850	200	5	3	6.3	5	6.3	3	9.11

Flush Mounting Transformers (type C)

C5509	R-6	600	50	5	2	6.3	2	2.5		3.59
C5510	R-7	700	75	5	3	6.3	3	2.5	8	4.59
C5511	R-8	750	100	5	3	6.3	4	2.5	10	5.59
C5512	R-9	800	125	5	3	6.3	4	6.3	2	6.47
C5513	R-10	850	200	5	3	6.3	5	6.3	3	8.23

Dimensions and Shipping Weights

Type	W.xD.xH.	Lbs.	Type	W.xD.xH.	Lbs.
R-1	3 x 2½ x 2½"	2½	R-8	3½ x 3 x 3½"	5½
R-2	3 x 2 x 3"	3½	R-9	4½ x 3½ x 4"	6½
R-3	3½ x 3 x 3"	6½	R-10	4½ x 3½ x 4½"	8½
R-4	4½ x 3½ x 3½"	6½	R-11	3 x 3½ x 3½"	4
R-5	4½ x 3½ x 4½"	8½	R-12	3½ x 3 x 4"	6½
R-6	3 x 2½ x 2½"	2½	R-13	3 x 4½ x 4"	8½
R-7	3 x 2 x 3½"	3	R-54	2½ x 2½ x 3½"	2½

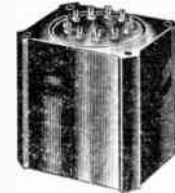

UTC "Linear Standard" Audios

Shielded high fidelity audio transformers. Lowest hum pick-up available. Uniform frequency response, low wave form distortion, high efficiency and thoroughly shielded. Multiple tap windings—wide combination of impedance terminations. **Guaranteed** uniform response within 1.3 db from 20 to 20,000 cycles. Threaded four-hole mounting for top or bottom mounting. All but LS-55 and LS-6L3 measure 3½" long, 2½" wide, 3½" high, with 6-32 screw mounting. Shipping weight 4 lbs.

No.	Type	Pri. Imp.	Sec. Imp.	Application	Each
C5401	LS-10	50, 125, 200, 250, 300, 600 in two sections	333, 500/600	Mike, pick-up or multiple line to grid	\$14.70
C5402	LS-10X	As above	50,000	As above	18.82
C5403	LS-12	50, 125, 200, 250, 333, 500/600	120,000 in two sections	As above for p.p. grids	16.46
C5404	LS-12X	As above	80,000 in two sections	As above	20.58
C5413	LS-21	15,000	135,000	Single plate to p.p. grids.	
C5405	LS-30	50, 125, 200, 250, 333, 500, 600	50, 125, 200, 250, 333, 500, 600	Split windings. Mixing, mike, pick-up, or multiple line to multiple line	14.11
C5406	LS-50	15,000	50, 125, 200, 250, 333, 500, 600	Single plate to multiple line	14.70
C5412	LS-55*	5,000 plate to plate	500, 333, 250, 200, 125, 50, 30, 20, 15, 10, 7.5, 5, 2.5, 1.2	P-p. 2A3's, 6A5G's, 300A's, 275A's, 6A3's, 6L6's	16.46
C5398	LS-6L3†	9,000 plate to plate	30, 20, 15, 10, 7.5, 5, 2.5, 1.2 bias	P-p. 6L6's self bias	16.46

*In LS-2 case 4½x3½x4½". Shpg. wt. 9 lbs.

†In LS-3 case 5½x5x4½". Shpg. wt. 17 lbs.

Reliance MERIT TRANSFORMERS

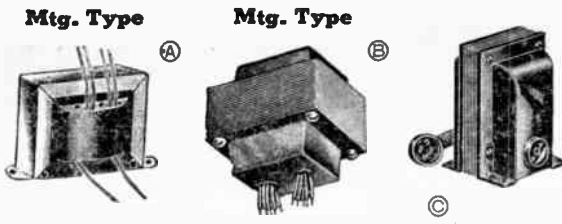

Reliance Transformers - Quality Performance at Economy Prices

Reliance transformers are practical transformers, designed for quality, performance and durability. Amazingly low prices are achieved by modern efficiency in factory production methods and equipment plus large volume purchases of raw materials at the most favorable market opportunities. Cool operation and perpetual freedom from mechanical hum are the result of Reliance's unique system of high-vacuum wax varnish impregnation. All laminations are cushion bonded and inter-lamination eddy currents are practically eliminated.

Output Transformers Receiver Replacements

(A) Class A oper. 3.5 ohms secondary. 5 watts max. 2" mtg. centers. 1 1/2" H, 2 3/8" W, 1 1/4" D.

Stock No.	Pri. Impedance	Pri. M.A.	Your Cost
C1964	2000	60	58c
C1965	5000	40	58c
C1966	7000	30	58c
C1967	10000	30	58c
C1968	15000	10	58c
C1969	25000 ct.	10	75c

Step-Down Transformers (C)

Most economical method of using standard voltage motors, accessories and appliances with line voltages from 220 to 250 v., 50-60 cy. Sec. voltage 110-125. Furnished with built-in receptacle and cord with plug. Use under all climatic conditions.

Stock No.	Watts	Size	Wt. Lbs.	Your Cost
C1981	80	3 3/8 x 3 1/2 x 2 1/8"	5	\$3.35
C1982	150	3 1/2 x 3 3/4 x 2 1/8"	7	4.10
C1983	250	4 1/4 x 3 1/2 x 3 3/8"	9	5.10
C1984	500	4 3/4 x 4 x 3 3/8"	12	6.50

Filament Transformers (A)

Stock No.	Primary Volts	Secondary Volts	Secondary Amperes	Dimen. H x W x D	Your Cost
C1950	115, 60 cy.	6.3 ct.	1	1 5/8 x 2 1/2 x 1 1/2"	\$0.87
C1951	115, 60 cy.	6.3 ct.	3	2 x 3 1/4 x 1 3/8"	1.35
C1952	115, 60 cy.	6.3 ct.	6	2 3/8 x 4 x 2 1/4"	2.10
C1953	115, 60 cy.	5 ct.	3	2 3/8 x 2 3/4 x 2"	1.33

Universal Output Transformers (A)

Stock No.	Class Oper.	Primary Impedance	Sec. Imp.	Max. Watts	Mtg. Ctrs.	Dimen. H, W, D.	Your Cost
C1954	Sin.	4000/7000	.17	to	4 2"	1 3/8 x 2 3/8 x 1 1/4"	\$0.87
C1955	P.P.	8000/10000	32	to	8 2 3/8"	1 3/8 x 2 1/2 x 1 1/2"	.97
C1956	"	14000 Ct.	"	18	2 3/8"	2 1/4 x 2 1/8 x 1 1/2"	1.30
C1957	Sin.	1500/2000	.1	to	10 2 3/8"	1 3/8 x 2 1/2 x 1 1/2"	1.15
		4000/5000	40	7000/10000			

Filter Chokes—Replacement Type

(A) All insulated for 1500 volts. Inductance ratings are at 60 cycles with rated current flowing per RMA recommendations.

Stock No.	Inductance Henries	Current M.A.	DC Res. Ohms	Mtg. Ctrs.	Dimen. H, W, D.	Your Cost
C1970	4.5	50	200	2 3/8"	1 5/8 x 2 1/2 x 1 1/2"	\$0.74
C1971	8.5	50	400	2 3/8"	1 3/8 x 2 1/2 x 1 1/2"	.74
C1972	16	50	550	2 1/2"	2 x 3 1/4 x 1 1/2"	.89
C1973	15	75	400	3 1/8"	2 1/4 x 3 1/2 x 2 1/8"	1.19
C1974	10.5	110	220	3 1/8"	2 3/8 x 4 x 2 1/4"	1.38

Power Transformers—Receiver Replacement

(B) Primary 115 v., 60 cy. Full-wave rectification. RMA color-coded leads. One 5-v. one 6.3-v. center-tapped filament winding.

Stock No.	H.V. Volts	Secondary DC Ma.	Fil. V. Amps.	Fil. V. Amps.	Mtg. Ctrs.	Your Cost
C1958	480 ct.	40	5	2 6.3	2 2 x 2 1/2"	\$2.05
C1959	650 ct.	40	5	2 6.3	2 2 x 2 1/2"	2.10
C1960	700 ct.	70	5	3 6.3	2 2 x 2 1/2"	2.65
C1961	700 ct.	90	5	3 6.3	3.5 2 1/2 x 2 1/2"	2.90
C1962	700 ct.	120	5	3 6.3	4.7 2 1/2 x 3 1/2"	3.45
C1963	750 ct.	150	5	3 6.3	5 2 1/2 x 3 1/2"	4.30



MERIT TRANSFORMERS—CHOKES—OUTPUT TRANSFORMERS

Embodying new developments, Merit Transformers have demonstrated dependable service under the most difficult conditions. Recognized and welcomed by thousands of satisfied users. Conform to the latest and most rigid specifications. Merit Transformers are now standard equipment with many leading radio and amplifier manufacturers.

The Merit line of transformers is especially designed to supply a simplified compact group of transformers which will meet 90% of all requirements in receiver servicing, construction of receivers, electronic control equipment, and amplifiers. Stock up now with a liberal selection of the items listed below.

Kits of Output Transformers (B) Save 10% by buying in Kits.

Handy kits of high-quality replacement transformers for practically all receivers encountered in service work, eliminate need for expensive universal output transformers. All have secondary impedances to match 3.5-ohm voice coils. Specifications of the transformers are in tabulation below.

Kit No. 1, 8 transformers: 2 No. 2928, 1 each 2930, 2931, 2932, 2934, 2936, 2937. **Your Cost \$6.22**

Kit No. 2, 8 transformers: 2 No. 2928, 2 No. 2937, 1 each 2930, 2931, 2934, 2936. **Your Cost \$6.46**

Kit No. 3, 8 transformers: 1 each 2928, 2930, 2931, 2932, 2933, 2934, 2937, 2938. **Your Cost \$6.24**

Kit No. 4, 8 transformers: 2 each 2928, 2931, 2936, 2937. **Your Cost \$6.83**

Power Transformers—Receiver Replacement Type

(A) High quality line of replacement-type power transformers, for 110-120 volt, 60 cy. line. Leads color coded to RMA recommendations. Each has one 5-volt rectifier fil., and one center-tapped tube-heater winding at 6.3 volts.

Stock No.	H.V. Winding	Sec. M.A.	D.C.	Fil. V. Amps.	Fil. V. Amps.	Mtg. Ctrs.	Your Cost
C1924	240-240	40	5	2 6.3	2 2	2 x 2 1/2"	\$2.50
C1925	325-325	40	5	2 6.3	2 2	2 x 2 1/2"	2.65
C1926	350-350	70	5	3 6.3	2.5 2	2 x 2 1/2"	3.38
C1927	350-350	90	5	3 6.3	3.5 2 1/2	2 1/2 x 2 1/2"	3.67

Mfr's No.	Pri. Imp.	Pri. M.A.	Max. Watts	Mtg. Ctrs.	Dimen. H x W x D	Your Cost
2928	2000	60	5	2"	1 3/8 x 2 3/8 x 1 1/4"	\$0.87
2930	5000	40	5	2"	1 3/8 x 2 3/8 x 1 1/4"	1.35
2931	7000	30	5	2"	1 3/8 x 2 3/8 x 1 1/4"	2.10
2932	10000	30	5	2"	1 3/8 x 2 3/8 x 1 1/4"	1.33
2936*	10000 ct.	40	10	2 3/8"	1 5/8 x 2 1/2 x 1 1/2"	\$0.87
2938	10000 ct.	40	5	2"	1 3/8 x 2 3/8 x 1 1/4"	1.35
2933	12000	10	5	2"	1 3/8 x 2 3/8 x 1 1/4"	2.10
2934	15000	10	5	2"	1 3/8 x 2 3/8 x 1 1/4"	1.33
2937	25000 ct.	10	5	2"	1 3/8 x 2 3/8 x 1 1/4"	1.15

*2936 is designed for PP 6AC5 in Class B or PP 6V6 or 7C5 in class AB1. All others designed for class A operation

Power Transformers—Fully Shielded, Upright Mounting Type (E)

Stock No.	H.V. Winding	Sec. M.A.	D.C.	Fil. V. Amps.	Fil. V. Amps.	Dimen. HxWxD	Mtg. Ctrs.	Your Cost
C1928	350-350	70	5	3 6.3	3	3 3/4 x 3 1/2 x 3 3/8"	2 1/2 x 1 1/2"	\$4.12
C1929	350-350	90	5	3 6.3	3.5	4 1/4 x 3 1/2 x 3 3/8"	2 3/4 x 2 1/4"	4.56
C1930	350-350	110	5	3 6.3	4.5	4 3/8 x 3 3/4 x 3 3/8"	3 x 2 1/4"	5.14

Universal Line Transformers

To couple various line impedances to a voice coil. Four primary taps to match 500, 1000, 1500 or 2000-ohm lines to remote speakers.

Stock No.	Sec. Imp.	Max. Watts	Dimen. H x W x D	Fig. (B), (D), (C)	Mtg. Ctrs.	Your Cost
C1931	3.2	10	1 3/8 x 2 1/2 x 1 1/2"	(B)	2 3/8"	\$1.12
C1932	6.8	18	2 1/4 x 2 3/8 x 1 3/8"	(D)	2 3/8"	1.91
C1933	6.8	24	2 1/4 x 3 1/2 x 2 1/2"	(C)	3 3/8"	2.06

USE OUR ORDER BLANK FOR FASTEST POSSIBLE SERVICE

STANCOR-Thordarson

TRANSMITTING TRANSFORMERS

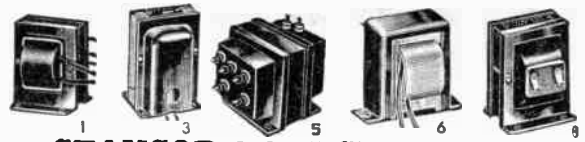

STANCOR TRANSFORMERS PLATE MODULATION TRANSFORMERS

No.	Type	Tubes	Sec. Imp.	Audio	Mtg.	Lbs.	Each
C1748	A3845	1-6A6, 6N7, 53, 79, 6Y7	3000, 5000 6500, 8000	25 W.	3	4	53.23
C1751	A3808	PP 6L6, 807, HY61, RK41, PP Par. 6L6	4000, 5000 7500, 10000	60 W.	8	8	7.29
C1757	A2907	PP 10, T20, TZ-20, HY25, 35, 46, 801, 809	3300, 5000, 6800, 9000, 12,500	90 W.	8	10	8.56
C1758	A2908	PP RK18, T20, TZ20, HY25, RK31, 35T, 50T	3000, 4500 5350, 6250	120 W.	8	11	9.03
C1759	A3829	P.P. RK 12, 57, HY25-40Z, T40, 809, 100TL	3000, 4000 5000, 6250	175 W.	8	12	9.73

PLATE TRANSFORMERS

Stock No.	Stancor Type	D.C.* Voltage	MA.	Mtg. Dimen. H. W. D.	Mtg.	Lbs.	Each
C1860	P8042	600	300	4 5/8 x 3 1/2 x 6 1/2"	3	16	\$12.88
C1861	P8043	750	300	7 1/2 x 6 1/2 x 8"	5	27	19.32
C1862	P8026	1250	300	7 5/8 x 7 1/2 x 8 3/4"	5	36	27.69
C1863	P8028	1500	300	7 5/8 x 7 1/2 x 9"	5	38	28.64
C1864	P8032	2000	300	7 5/8 x 7 1/2 x 9 3/4"	5	45	36.13

FILAMENT TRANSFORMERS

No.	Type	Sec. V.	Amps.	HxWxD	Mtg.	Lbs.	Each
C1774	P3060	2.5	10	3 1/2 x 2 1/2 x 2 1/2"	6	3	\$2.91
C1790	P4088	5.0	3	3 1/2 x 2 1/2 x 2 1/2"	6	2	2.00
C1779	P5014	6.3	3	3 1/2 x 2 1/2 x 2 1/2"	6	2	2.20
C1775	P3064	6.3	6	3 1/2 x 2 1/2 x 2 1/2"	6	3	2.70
C1780	P5015	7.5	4	3 1/2 x 2 1/2 x 2 1/2"	6	3	2.41
C1782	P6138	7.5	8	3 1/2 x 3 1/2 x 2 1/2"	6	4	3.38
C1781	P5016	10.0	4	3 1/2 x 3 1/2 x 2 1/2"	6	3	2.70
C1791	P4096	10.0	5	3 1/2 x 3 1/2 x 3 1/2"	3	5	4.03

All secondaries C.T.—All primaries 115 V. 60 cycles.

DRIVER TRANSFORMERS

Driver tubes listed in order of preference with best listed first.

No.	Type	From	To	Class	Mtg.	Each
C1692	A4752	1-6G6G, 6F6, 42, 2A5 as TRIODES	P. P. GRIDS 6V6, 6Y6, 6F6, 6L6, 6Z7	AB	6	\$2.03
C1897	A4702	1-2A3, 45, 46, 89, 2A5, 6F6, 42	PP 6L6, 6V6, 6F6, 45, PP Par. 6L6	AB2 AB1	3	2.97

POLY-PEDANCE MODULATION TRANSFORMERS

Tapped to give wide range impedances for correctly matching every type load. Impedance chart and instructions with each unit.

Stock No.	Type No.	Max. Audio	Pri. Ma. Per Side	Sec. Ma. Ser. Par.	Dimen. HxWxD	Type Mtg.	Each
C1621	A-3892	30W	80	80 160	3 1/2 x 3 1/2 x 4 3/4"	1	\$6.09
C1622	A-3893	60W	125	125 250	3 1/2 x 3 1/2 x 4 3/4"	1	7.14
C1627	A-3894	125W	150	150 300	4 1/2 x 3 1/2 x 5 1/2"	1	9.44

Shpg. wts.: C1621, 6 lbs.; C1622, 8 lbs.; C1627, 14 lbs.

SWINGING CHOKES

No.	Type	Hys.	Ma. Ohms	HxWxD	Mtg.	Wt. Lbs.	Each
C1827	C1400	12-2	175	100	3 1/2 x 2 1/2 x 2 1/2"	3	\$2.70
C1766	C1702	12-2	250	60	3 1/2 x 2 1/2 x 3"	6	3.56
C1829	C1402	12-2	250	60	3 1/2 x 3 1/2 x 3 1/2"	3	3.94
C1769	C1720	20-1	300	80	4 1/2 x 3 1/2 x 3 1/2"	6	4.50

FILTER CHOKES

No.	Type	Hys.	Ma. Ohms	HxWxD	Mtg.	Wt. Lbs.	Each
C1830	C1410	4	175	100	3 1/2 x 2 1/2 x 2 1/2"	3	\$2.56
C1831	C1411	4.5	200	80	3 1/2 x 2 1/2 x 3 1/2"	3	3.35
C1832	C1646	5	200	90	3 1/2 x 3 1/2 x 3 1/2"	3	3.73
C1767	C1703	4	250	60	3 1/2 x 3 1/2 x 3 1/2"	6	3.56
C1833	C1413	8	300	80	4 1/2 x 3 1/2 x 3 1/2"	8	6.17

POLY-PEDANCE DRIVER TRANSFORMERS

Tapped to give usable ratios in Class B Drivers. Cap. of C1616 and C1617, 15 wats; primary per side,—60 ma. Cap. C1618, 30 wats; primary 120 ma. per side. All type 1 mtg. Wt. 4 lbs.

Stock No.	Type No.	Ratio Primary to 1/2 Secondary	Dimen. HxWxD	Each
C1616	A-4761	1.25:1, 1.4:1, 1.6:1, 1.8:1, 2:1, 2.2:1, 2.4:1	3 1/2 x 2 3/8 x 3 1/4"	\$6.56
C1617	A-4762	2.6:1, 3:1, 3.2:1, 3.4:1, 4:1, 4.5:1, 5:1	3 1/2 x 2 3/8 x 3 1/4"	6.17
C1618	A-4763	1.25:1, 1.5:1, 1.75:1, 2:1, 2.25:1, 3.2:1	3 1/2 x 3 1/4 x 1"	7.14

THORDARSON TRANSMITTING TRANSFORMERS



FILAMENT TRANSFORMERS

Ratings for continuous operation at peak load. Primary 117 volt 50/60 cycles. RMS insulation voltage 1600 on all except *RMS insulation voltage 750 †RMS Insulation voltage 10,000 **tapped sec. ‡tapped primary.

Stock No.	Type No.	Volts	Amps.	Mtg.	Your Cost
C2037	T21F00	2.5 CT	5	BAV	\$1.91
C2038	T21F01	2.5 CT	10	BAV	2.47
C2039	T21F02*	2.5 CT	10	CAV	2.94
C2040	T21F03	5 CT	3	BAV	1.94
C2041	T21F04	5 CT	7	CAV	3.29
C2139	T21F20†	5 CT	15	CAV	5.00
C2042	T21F05†	5 CT	3	CAV	2.94
C2043	T21F06	5 CT	13	CAV	3.23
C2044	T21F07	5 CT	21	CAV	4.41
C2045	T21F08	6.3 CT	1	BAV	1.59
C2046	T21F10	6.3 CT	3	BAH	1.91
C2047	T21F11	6.3 CT	6	CAV	3.29
C2048	T21F12	6.3 CT	10	CAV	3.29
C2049	T21F14**	6.3-5-2.5	2.5	BAH	2.12
C2050	T21F15	7.5 CT	4	BAV	2.35
C2051	T21F16	7.5 CT	8	CAV	3.23
C2052	T21F17	7.5 CT	12	CAV	3.67
C2053	T21F18	10 CT	5	CAV	2.94
C2054	T21F19‡	10 CT	12	CAV	4.41
		11 CT	11		

PLATE TRANSFORMERS

Electrostatic shields. Current ratings are for CCS (continuous commercial service.) ICAS (Interrupted Commercial Amateur Service) ratings approximately 25% higher.

Stock No.	Type No.	Mtg. Type	DC Volts	MA.	Your Cost
C2066	T21P75	PUV	2500-2000-1250	500	\$79.38
C2067	T21P77	PUV	2500-2000	300	55.86
C2068	T21P79	PUV	1580-1250	400	39.69
C2069	T21P81	PUV	1250-1000	300	33.81
C2070	T21P82	PUV	2000-1500	220	35.28
C2071	T21P83	PUV	1250-1000	200	21.76
C2072	T21P85	PUV	600-500	300	14.99
C2073	T21P87	GGV	650-500	220	8.82
C2077	T21P89	GGV	400	175	5.29
C2078	T21P91	PUV	1000-750	150-110	15.88
C2080	T21P93	GGV	1000-400	95-125	8.82

SPLATTER SUPPRESSOR CHOKES

Attenuates audio modulating frequencies over 3000 CPS, eliminates splatter harmonics generated in speech amplifier.

Stock No.	Type No.	Application	DC Res.	Mtg. Type	Your Cost
C2024	T20C60	Induct. 2 to 1.5H at 300MA DC	30	KTV	\$ 8.23
C2025	T20C61	Induct. 2 to 1.5H at 500MA DC	27	KTV	10.00

MODULATION TRANSFORMERS

For specific tube types with low and medium power.

Stock No.	Type No.	Primary Application	Impedance Primary	Sec.	Audio Pwr.	Mtg. Type	Your Cost
C2055	T21M50	1-19, etc.	10000CT	4500	3	BAH	\$1.65
C2056	T21M52	6N7, etc.	10000CT	4500-3750	10	FGV	2.35
				3000			
C2057	T21M54	PP 6L6, etc.	6600CT	4000	25	GGV	3.38
C2058	T21M56	TZ2-809, etc.	10000CT	6600-3750	75	GGV	5.29
C2059	T21M58	811-812, etc.	15000CT	6250	100	KTV	13.23

MULTI-MATCH MODULATION TRANSFORMERS

Enables accurate matching of various tube-loads without changing transformers. For medium and high power requirements. *Line to RF load. sec. Imp. 5M, 6M, 7M, 8M, 9M, 10M.

Stock No.	Type No.	Pri. Ma. each side	Sec. MA Series	Audio Pwr.	Mtg. Type	Your Cost	
C2060	T21M60	50	50	100	15	KTV	\$ 7.06
C2061	T21M61	125	125	250	60	PUV	10.58
C2062	T21M62	210	160	320	125	PUV	16.17
C2063	T21M64	250	250	500	300	PUV	27.93
C2064	T21M65	320	320	640	500	PUV	47.04
C2065	T21M66*	500 ohm line	200	500	500	KTV	111.76

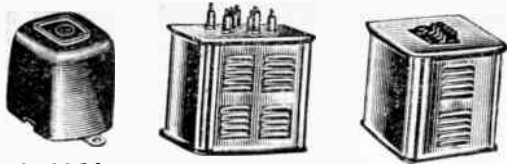

G1 TO G4

G5 TO G11

Class A Input Transformers

No.	Type	Application	Ratio	Case	Wt.	Each
C5802	S-2	1 plate* to 2 grids.....	2:1	G-2	3½ lbs.	\$3.72
C5804	S-4	1 plate* to 2 grids, wide range response.....	1:1	G-3	4	5.10
C5805	S-5	Single or double button mike or line to 1 grid; hum bucking type.....	16:1	G-2	3½	4.16
C5806	S-6	Single or double button mike or line to 1 grid, compact type.....	16:1	G-1	3	3.04

*Will match tubes like 6C5, 56, 6C6 triode, 77 triode, etc. Can be used with high mu triodes with loss in low frequencies.

Universal Output To Line and Voice Coil

All secondaries designed to match 2, 8 and 15 ohm voice coils and 500 ohm line. Shpg. wts.: G-2, 3½ lbs., G-1, 5 lbs.

No.	Type	Primary Ohms	Watts	Case	Each
C5814	S-14	2500, 4000, 7000.....	10	G-2	\$4.41
C5815	S-15	4000, 5000, 10,000.....	12	G-2	4.61
C5816	S-16	3000, 6000-6600, 10,000.....	30	G-4	6.08

Universal Modulation Transformers

Designed to match any modulator tubes to any RF load. Secondary will carry DC current of a Class C stage.

No.	Type	Watts	Case	Lbs.	Each
C5818	S-18	12	G-3	4	\$4.90
C5819	S-19	30	G-4	5	7.35
C5820	S-20	55	G-5	6½	10.78
C5821	S-21	110	G-7	11	15.19
C5822	S-22	250	G-9	23	23.52

Matching Transformer

Stock No.	Type No.	Application	Pri. Ohms	Sec. Ohms	Case	Your Cost
C5811	S-11	Single 56, 6C6 triode, 6C5 or similar tube to line.....	10,000	200, 500	G-2	\$4.16

Universal Driver Transformer

No.	Type	Application	Case	Lbs.	Each
C5809	S-9	P.P. Driver plates to grids of Class B tubes up to 400 watts output.....	G-3	4	\$5.10

Multiple Secondary Filament Windings

Primaries tapped 105, 115 volts, 50 60 cycles AC. All secondaries center tapped. Shpg. wt., each, 6½ lbs.

Stock No.	Type No.	Fil. No. 1 Volts Amps.	Fil. No. 2 Volts Amps.	Fil. No. 3 Volts Amps.	Case	Your Cost
C5865	S-65	2.5 5	5 4	6.3 3	G-5	\$5.39
C5868	S-68	5 3	6.3 4	7.5 5	G-5	5.88
C5870	S-70	6.3 5	6.3 5		G-5	5.88

All 3000 volt insulation.

Filter, Swinging and Audio Chokes

No.	Type	Service	Hf.	Ma.	Ohms	Case	Each
C5823	Δ S-23	Audio	500	5	6000	G-2	\$3.33
C5827	*S-27	Filter	30	75	350	G-4	3.72
C5828	*S-28	Filter	20	100	350	G-4	3.72
C5829	*S-29	Filter	10	175	95	G-4	3.72
C5830	*S-30	Swing.	5/25	175	95	G-4	3.72
C5831	*S-31	Filter	20	225	120	G-5	4.90
C5832	*S-32	Swing.	5/25	225	120	G-5	4.90
C5833	Δ S-33	Filter	20	300	90	G-7	6.86
C5834	Δ S-34	Swing.	5/25	300	90	G-7	6.86
C5835	Δ S-35	Swing.	5/25	400	85	G-8	10.29
C5837	Δ S-37	Filter	20	550	60	G-8	13.72

Shpg. wts.: Δ 3½ lbs., *6 lbs., †11 lbs., ‡15 lbs.

Case Dimensions

Type	Height	Width	Depth	Type	Height	Width	Depth
G1	1¼"	2½"	1¾"	G8	4½"	5¾"	5¾"
G2	2¼"	3¾"	1¾"	G9	5½"	5¾"	6¾"
G3	2¼"	3¾"	2¾"	G10	5½"	6¾"	6¾"
G4	2½"	4½"	2¾"	G11	5½"	6½"	7¾"
G5	3¾"	3½"	4½"	G12	10¼"	7¾"	9¼"
G7	4¾"	4¾"	5½"				

UTC Transmitting Transformers

Plate Transformers

Primaries for 115 v., 50 60 cycles a.c. For duplex rectifiers, the high and low voltage output of any of the units listed below can be used simultaneously. The rated d.c. current can be divided as required between both voltage outputs.

No.	Type	High Voltage	Ma.	Case	Lbs.	Each
C5344	S-14	575-525-0-525-575.....	500	G-9	23	\$15.19
C5845	S-45	900-750-0-750-900.....	200	G-8	15	11.76
C5846	S-46	1000-750-0-750-1000....	300	G-9	23	14.70
C5847	S-47	1500-1250-1000-0-1000-1250-1500.....	300	G-10	27	18.62
C5848	S-48	1500-1250-1000-0-1000-1250-1500.....	500	G-11	34	27.44
C5850	S-50	3000-2500-0-2500-3000..	300	G-12	55	36.26

Plate and Filament Transformers

All primaries for 115 volts, 50/60 cycles a.c. High volt. 490-400-0-400-490 at 175 ma.; 5 v. at 3 a. (rect.); 2.5 v. c.t. at 6 a.; 6.3 v. c.t. at 4 a. G-7. Wt. 11 lbs.

C5839	S-39	Your Cost	\$10.29
C5840	S-40	Your Cost	\$10.29
C5841	S-41	Your Cost	\$9.31
C5842	S-42	Your Cost	\$12.25

Single Secondary Filament Transformers

Primaries tapped 105, 115 volts, 50 60 cycles a.c.

No.	Type	Sec. Volts	Amps.	Insul.	Case	Lbs.	Each
C5853	S-53	2.5 c.t.	10	1500 v.	G-3	4	\$3.14
C5854	S-54	5 c.t.	4	2500 v.	G-3	4	3.14
C5855	S-55	6.3 c.t.	3	1500 v.	G-3	4	3.14
C5857	S-57	2.5 c.t.	10	10000 v.	G-5	6½	4.41
C5858	S-58	2.5 c.t.	20	10000 v.	G-5	6½	5.39
C5859	S-59	5 to 5.25 c.t.	13	5000 v.	G-5	6½	4.41
C5861	S-61	7.5 tapped, 6.3 c.t.	8	3000 v.	G-5	6½	4.41
C5862	S-62	10 c.t.	10	5000 v.	G-5	6½	5.39
C5863	S-63	14 v. c.t. tapped at 12 v. c.t., 11 v. c.t.	10	5000 v.	G-7	11	9.80

Ultra-Compact Line Matching

Compact high fidelity units having a frequency range from 30 to 20,000 c.p.s. Only 1x1x1" threaded inserts for mounting. Match 50, 125, 200, 250, 500 ohm lines. Net wt. 6 oz.; shpg. wt. each 1 lb.

C5394	A-10	Line to 1 grid, 50,000 ohms.	\$8.82
C5397	A-24	1 Triode plate 8000/15000 ohms to line.	\$8.82

Your Cost Each, Either Above Type..... \$8.82
Multiple Alloy Shield Type: Frequency range from 50 to 10,000 c.p.s. and has multiple alloy shield for extremely low hum pickup. Matches 50, 200 or 500 ohms to 1 or 2 grids.
C5726—Type A-11. Your Cost Each..... \$8.82

Varimatch Modulation Transformers

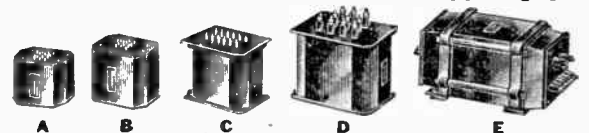

Universal modulation transformers with tapped primary and secondary windings for matching all popular types of modulator tubes to plate modulated Class C amplifier stage. Secondaries are designed to carry the plate current of the Class C stage.

Stock No.	Type	Max. Watts Audio Class C Stage	L.	Size W.	H.	Case	Shpg. Wt.	Your Cost
C5359	VM-0	12 10-25	2½"	3"	3"	A	3	\$5.00
C5360	VM-1	30 20-60	3½"	4½"	4½"	A	6	8.23
C5361	VM-2	60 40-120	3¾"	4¾"	4½"	B	12	12.05
C5362	VM-3	125 100-250	6"	4¾"	6"	C	20	17.64
C5363	VM-4	300 200-600	7¾"	9"	5½"	D	31	29.40
C5364	VM-5	600 450-1000	11"	11"	9"	E	89	67.62

All-Purpose SOCKETS

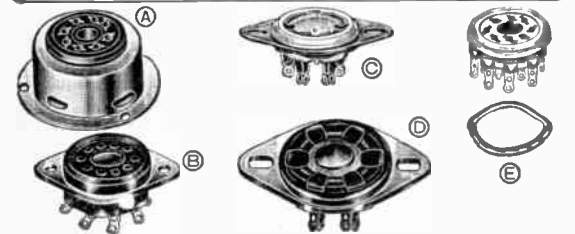

AMPHENOL Above-Chassis Sockets

(A) For mounting above the level of the chassis surface. Bakelite socket with various prong arrangements as below, in metal shell. Height $1\frac{1}{16}$ " above sub-panel or chassis surface. Has 4 knockouts for leads, plus mounting flange.

No.	Prongs	No.	Prongs
C13100	4	C13103	7 S
C13101	5	C13104	7 L
C13102	6		

Any Type Above, Your Cost Each **15¢**
 C13105—7 L. & S. C13106—Oct. Either Type Above, Your Cost Each **17¢**

AMPHENOL "MIP"

(B) Molded from high-dielectric black bakelite, with molded-in plate for $1\frac{1}{2}$ " mounting centers. Cannot come loose or rattle. Strong, dependable.

Stock No.	Prongs	Your Cost Each
C13164	4	7¢
C13165	5	
C13166	6	
C13167	7 small	9¢
C13168	7 large	
C13169	8 octal	11¢
C13223	9	
C13224	11	14¢

Midget "MIP" Octal

Smaller, more compact than above. Has $1\frac{1}{4}$ " mtg. centers. Octal, 8 prongs, only. C13225—Your Cost Each **8¢**
 C13243—"MIP" Loktal Type. Your Cost, Each **13¢**

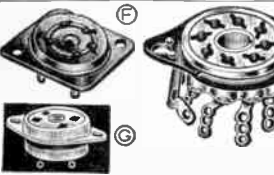

National Isolantite "CIR" Locking Ring Sockets

(F) Low loss isolantite sockets can be locked in metal flange. Ideal for h.f. receivers and xmitters.

No.	Prongs	No.	Prongs
C14534	4	C14537	7 small
C14535	5	C14538	7 large
C14536	6	C14539	8 octal

Any Type, Your Cost **27¢**

MILLEN Sockets

(C) Much higher Steatite body used to provide increased insulation. Barriers separate all contacts, permitting use of higher than ordinarily used voltages. Sht. No. Mfrs. No. Prongs. Each

C8045	3300.	4
C8046	33005	5
C8047	33006	6
C8049	33008	Octal

AMPHENOL Steatite Socket

(C) Withstand higher temperatures, do not absorb moisture. Contacts are phosphor bronze, all silver-plated for low resistance connections with the tube prongs.

Prongs	Stock No.	Each
4	C13194	28¢
5	C13195	28¢
6	C13196	28¢
7S	C13197	28¢
7L	C13198	36¢
8 octal	C13199	28¢

AMPHENOL Standard Tube Sockets

Type "D" is designed for general replacement work and has a steel adapter plate to fit mounting centers from $1\frac{1}{2}$ " to $1\frac{1}{8}$ ". Type "E" is for new work and requires only a single $1\frac{1}{16}$ " hole, being held in place with a retainer ring, unusually easy to mount. Both types available in Bakelite. 9 and 11 prong sockets are for Amphentol connectors. 7C sockets fit small and large base tubes.

No.	(E)	(D)	Stock No.	Stock No.	Each
4	C13207	C13057	8c		
5	C13208	C13058	8c		
6	C13209	C13059	8c		
7S	C13210	C13061	8c		
7L	C13211	C13060	8c		
7C	C13237	C13056	10c		
8 octal	C13212	C13050	10c		
8 loktal	C13045	C13040	13c		
9	C13213	C13041	12c		
11	C13214	C13042	17c		

AMPHENOL Polystyrene Socket

(H) Molded polystyrene base. Fine for U.H.F. work. 8 prongs. Caution: Solder fast! Do not heat beyond 200° F. $1\frac{1}{2}$ " hole— $1\frac{1}{2}$ " centers. C13170—Octal, Each **28¢**
 C13160—Loktal, Your Cost Each **32¢**

Magic Eye Assembly

(J) For installation in any set having AVC. 6-prong type requires 6E5 or 6G5 tube for 6.3V. sets; 2E5 for 2.5V. sets. 8-prong type requires a 6AD6G or 6AP6G. Easily installed—complete instructions. C11480—6-prong C12645—8-prong Either Type, Your Cost **89¢**
 Both less tube, Each **89¢**
 C11481—Escutcheon for octal. **21c**
 C11482—Escutcheon for 6-prong **18c**

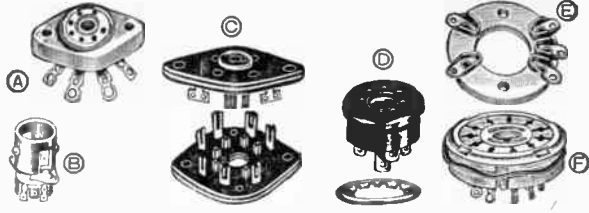

JOHNSON Miniature Sockets and Shields

(A) Designed for use with the 9000 series and Miniature series tubes, including 1S4, 1S5, 1T4, etc. Contacts are phosphor bronze, heavily silver plated and are self-aligning. Designed to permit a minimum amount of capacity between contacts. Exceptionally low-loss construction.

C13186 Type 267. Your Cost **29¢**

(B) No. 277B—Steatite socket with metal ring extending upward to form a shield base. C13219—Your Cost **44¢**

No. 277S—Miniature socket shield base only. C13220—Your Cost **9¢**

No. 278A— $1\frac{1}{8}$ " shield for 277B or S. C13221—Your Cost **12¢**

No. 278B— $1\frac{1}{4}$ " shield for 277B or S. C13222—Your Cost **12¢**

Wafer Sockets

(C) Sturdily constructed of laminated Bakelite. Heavily plated, self-aligning, floating one piece contacts. Have $1\frac{1}{2}$ " mounting centers.

Stock No.	Prongs	Your Cost Each
C13114	Four	6¢
C13115	Five	
C13121	Six	
C13122	7, small	
C13125	7, large	
C13127	8, octal	
C13075	8 Loktal	10 for... 54c

"Miniature" Wafer

For the ultra-compact all glass tubes ($\frac{3}{8}$ " dia.) 7-pin type. Mtg. center, $\frac{7}{8}$ ". C13097—Each **8¢**
 10 For **72c**

AMPHENOL Miniature Tube Sockets

For the New RCA Hytron, Raytheon and Cetron Baby Tubes

(D) For the new miniature tubes of all makes for use in hearing aids, pocket radios, remote controls, measuring devices, etc. All mounting holes $\frac{3}{4}$ " except Raytheon ($\frac{1}{2}$ "). Correct retainer ring supplied with socket.

Designed for RCA Tubes

C13173—Black Bakelite. **13c**
 C13172—As above, but of molded polystyrene for UHF work. Each **25c**

For Hythron Tubes For HY113, HY115, HY125.

C11542—Black Bakelite. Ea. **13c**

For Raytheon Tubes For CK501, CK502, CK503, CK504.

C11598—Black Bakelite. Ea. **13c**

For Photo Cells To fit RCA Pee-Wee and Cetron CE-5B11, CE-20 photo-cells.

C11599—Black Bakelite. Ea. **10c**

Acorn Tube Socket

(E) Loss loss socket with rugged spring contacts for 954 and 955 tubes. Constructed of ceramic material. 586980—Your Cost **19¢**
 C13156—Socket and mount for 922, 921 tubes. Your Cost **59¢**

C-R Tube Socket

(F) Magnol type C-R socket with 11 silver-plated contacts. Substantial barriers between each contact increase the leakage path resulting in less loss, thus reducing possible voltage breakdown. Complete with retainer ring for direct chassis mounting. C13185—Your Cost, Each **71¢**



Steatite UHF Socket

(A) Johnson No. 122-101. A 7-pin steatite wafer socket incorporating a base shield, retainer springs and provision for mounting button mica capacitors directly to socket thus keeping leads short. Designed for UHF use with tubes such as the 826, 829, and 832. Contacts and spring silver plated and recessed to prevent movement. Grid terminals designed so connecting wires may be isolated and permit small grid coils to be mounted on terminal ends for tank-circuit use. Four mounting poles 2.312" between centers. C14159—Your Cost **\$1.76**

JOHNSON 237 Socket

For 813 and 11K257 tubes. Low loss steatite socket excellent for use at high and ultra high frequencies. Cadmium plated contacts reinforced with recessed cadmium plated steel springs. Size $2\frac{1}{2}$ " square, $1\frac{1}{8}$ " matching centers. C14158—Your Cost **65¢**

JOHNSON Sockets

(B) Low-absorption ceramic base. Heavy phosphor bronze contacts, cadmium-plated, with double filament springs. Heavy nickel-plated brass shells. C14160—UX base. Ea. **65¢**
 C14161—50 Watt base. Your Cost **94¢**
 C14157—Giant 5-prong socket, for RCA 803, RK 28, etc. Your Cost **\$1.47**

JOHNSON 275 Socket

(C) For Eimac type 4-125A and 4-250 A tubes. Steatite insulation. Contacts cadmium plated, reinforced with cadmium plated steel springs. Metal parts counter sunk and mtg. holes bussed for panel mtg. 5 prong $2\frac{1}{4}$ " square, with $\frac{3}{8}$ " mtg. holes on $2\frac{1}{4}$ " centers. C14156—Your Cost **\$1.03**

JOHNSON 247 Socket

7 pin Steatite wafer socket for 829, 826, etc. with aluminum base shield. C13187—Your Cost **73¢**

AMPHENOL 83 Series UHF Connectors



This line of UHF low-loss single contact connectors and adapters for use with RG type cables serves all practical applications and they are made in both small and large sizes for coax and twinax cable. Very ruggedly constructed of die cast zinc and machined brass shells, silver plated. Easy assembly and positive connection.

- C11550**—83-1SP 2 piece straight plug with molded low loss mica filled insert. **82¢**
- C11551**—83-1R Receptacle chassis or box type. Low-loss mica filled insert. **\$1.22**
- C11552**—83-1AP Angle plug adapter. Polystyrene insert—pin and socket. **\$1.46**
- C11553**—83-1T "T" connector. For 83-1R, factory wired **\$1.80**
- C11554**—83-1J Junction for use with 83-1SP—double contact. **\$1.14**

- C11555**—83-1F Feed thru connector, similar in appearance to 83-11, but threaded entire length and equipped with two hex-nuts. Polystyrene insert **\$1.73**
- C11556**—83-1H Hood for RG cables 8/U, 10/U, 11/U, 22/U, 63/U, 65/U. **14¢**
- C11557**—83-168 Adapter for small cable, RG59/U, use with 83-1SP connector. **21¢**
- C11558**—83-185 Adapter for small cable, RG58/U, use with 83-1SP Connector. **21¢**

AMPHENOL Receptacles and Plugs

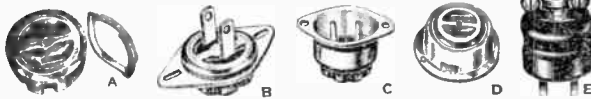

Molded black bakelite insulation 2-pole receptacles have one elongated hole and can be used with both the standard type of plug and the polarized type, having one $\frac{1}{4}$ " and one $\frac{3}{16}$ " blade. 3 pole receptacles are for use with 3 pole plugs. Underwriters ratings: 15A—125V, or 10A-250V. Dimensions: (A) hole—1.172", (B) Mtg. ctrs.— $1\frac{1}{2}$ " to 1 7/8", (C) hole— $1\frac{1}{4}$ ", Mtg. ctrs.— $1\frac{1}{4}$ " (D) diam.— $2\frac{1}{8}$ ", height— $1\frac{1}{8}$ ", (E) diam. $1\frac{1}{8}$ ".

- | | | | |
|-----------------------|------------------|-------------------------|------------------|
| PLAIN (A) | | FLUSH (C) | |
| No. Poles | Type | No. Poles | Type |
| C11502 | 2 Receptacle | C11504 | 2 Receptacle |
| C11503 | 2 Standard Plug | C11505 | 2 Standard Plug |
| C11624 | 2 Polarized Plug | C11635 | 2 Polarized Plug |
| C11625 | 3 Receptacle | | |
| C11626 | 3 Polarized Plug | | |
| WITH PLATE (B) | | SURFACE TYPE (D) | |
| C11500 | 2 Receptacle | C11637 | 2 Receptacle |
| C11501 | 2 Standard Plug | C11638 | 2 Standard Plug |
| C11627 | 2 Polarized Plug | C11639 | 2 Polarized Plug |
- Each 18c, 25c, 20c, 28c, 25c

SHIELDED PLUGS AND RECEPTACLES (E)

	Receptacle	Std. plug	Polarized plug	Each
2 pole with $\frac{1}{2}$ " clamp	C11546	C11545	C11647	32c
2 pole side outlet less clamp	C11548	C11547	C11650	28c
2 pole end outlet less clamp	C11651	C11652	C11653	28c
3 pole end outlet with clamp	C11648	C11649		39c

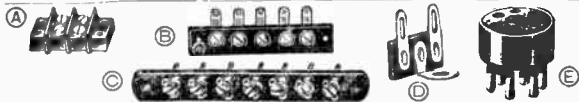

- JONES Terminal Strips**
- (A) No. 140— $\frac{7}{8}$ " wide by $\frac{1}{2}$ " high. Terminals are mounted on $\frac{3}{8}$ " centers. $\frac{1}{4}$ " metal to metal spacing over bakelite.
- No. 141— $1\frac{1}{8}$ " wide by $\frac{1}{2}$ " high. Terminals mounted on $\frac{1}{16}$ " centers. $\frac{3}{8}$ " metal to metal spacing over bakelite.
- | | | | |
|---------|--------|---------|--------|
| No. 140 | 10 For | No. 141 | 10 For |
| C12527 | 13c | C12529 | 17c |
| C12528 | 18c | C12540 | 23c |
| C12529 | 23c | C12541 | 28c |
| C12530 | 27c | C12542 | 34c |
| C12531 | 31c | C12543 | 40c |
| C12532 | 36c | C12544 | 47c |
| C12533 | 41c | C12545 | 53c |
| C12534 | 46c | C12546 | 59c |
| C12535 | 51c | C12547 | 66c |
| C12536 | 55c | C12548 | 72c |
| C12537 | 60c | C12549 | 77c |

- Heavy Bakelite Strips**
- (C) Screw and collar terminals bakelite strips, $\frac{1}{8}$ " wide.
- | | | |
|---------------|-----|------------|
| No. Terminals | Ea. | 10 For |
| C13140 | 2 | 11c \$0.99 |
| C13141 | 3 | 14c 1.26 |
| C13142 | 4 | 17c 1.53 |
| C13143 | 5 | 20c 1.80 |
| C13144 | 6 | 23c 2.07 |
| C13230 | 7 | 26c 2.34 |
| C13231 | 8 | 29c 2.61 |
| C13232 | 9 | 32c 2.88 |
| C13233 | 10 | 35c 3.15 |
- Bakelite Mounting Strip**
- (D) For mounting parts on chassis.
- | | | | |
|-----------|------|------|--------|
| Stock No. | Lugs | Each | 10 For |
| C13124 | 1 | 2c | 14c |
| C13133 | 2 | 3c | 16c |
| C13134 | 3 | 3c | 19c |
| C13135 | 4 | 4c | 31c |
| C13137 | 6 | 5c | 45c |
- Standard Speaker Plugs**
- (E) 1-piece molded bakelite, speaker cables easily wired.
- | | |
|----------------|----------------|
| No. Type | No. Type |
| C11512 4 prong | C11514 6 prong |
| C11513 5 prong | C11515 7 prong |
- Your cost any above... 8c
C11516 8 prong... 10c

- Terminal Strips**
- (B) Hi-quality bakelite terminal strips, $\frac{1}{16}$ " thick.
- | | | |
|---------------|-----|-----------|
| No. Terminals | Ea. | 10 For |
| C13145 | 2 | 6c \$0.54 |
| C13123 | 3 | 9c .81 |
| C13112 | 4 | 11c .99 |
| C13113 | 6 | 16c 1.44 |

PLUGS and CONNECTORS

JONES PLUGS AND SOCKETS

Multiple contact plugs and sockets in both "400" series heavy duty (25 ampere) and "300" series standard duty (5 ampere) sizes. Cable type plugs and sockets have cable clamps. Chassis type have brackets—heavy duty type at ends—standard duty type at sides.

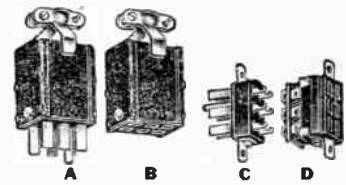

- | | | | | | | | | | |
|---------------------|------------|---------------|------------|-----------------------|---------------|---------------|------------|--------|--------|
| TYPE A PLUGS | | | | TYPE B SOCKETS | | | | | |
| Standard Duty | Heavy Duty | Standard Duty | Heavy Duty | Standard Duty | Heavy Duty | Standard Duty | Heavy Duty | | |
| Stock No. | Your Cost | Con-Stock No. | Duty Cost | Stock No. | Con-Stock No. | Stock No. | Duty Cost | | |
| C12460 | 28c | 2 | C12400 | 48c | C12466 | 28c | 2 | C12412 | 51c |
| C12461 | 33c | 4 | C12401 | 58c | C12467 | 33c | 4 | C12413 | 65c |
| C12462 | 36c | 6 | C12402 | 68c | C12468 | 38c | 6 | C12414 | 78c |
| C12463 | 40c | 8 | C12403 | 77c | C12469 | 44c | 8 | C12415 | 92c |
| C12464 | 45c | 10 | C12404 | 87c | C12470 | 50c | 10 | C12416 | \$1.05 |
| C12465 | 49c | 12 | C12405 | 98c | C12471 | 56c | 12 | C12417 | 1.19 |
-
- | | | | | | | | | | |
|------------------------------|------------|---------------|------------|--------------------------------|---------------|---------------|------------|--------|-----|
| Chassis Type Plug (C) | | | | Chassis Type Socket (D) | | | | | |
| Standard Duty | Heavy Duty | Standard Duty | Heavy Duty | Standard Duty | Heavy Duty | Standard Duty | Heavy Duty | | |
| Stock No. | Your Cost | Con-Stock No. | Duty Cost | Stock No. | Con-Stock No. | Stock No. | Duty Cost | | |
| C12472 | 13c | 2 | C12426 | 30c | C12478 | 14c | 2 | C12406 | 34c |
| C12473 | 17c | 4 | C12427 | 37c | C12479 | 19c | 4 | C12407 | 44c |
| C12474 | 21c | 6 | C12428 | 44c | C12480 | 23c | 6 | C12408 | 54c |
| C12475 | 24c | 8 | C12429 | 51c | C12481 | 27c | 8 | C12409 | 64c |
| C12476 | 27c | 10 | C12430 | 58c | C12482 | 33c | 10 | C12410 | 74c |
| C12477 | 31c | 12 | C12431 | 64c | C12483 | 38c | 12 | C12411 | 84c |

CONNECTORS—SOCKETS—PLUGS

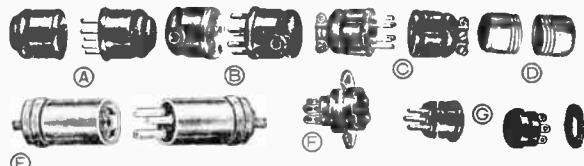

- Cable Connectors**
- (A) Tube-base connectors with shield caps. Rubber-grommet cable opening at end for protection against abrasion.
- | | | | |
|--------|--------|----------|------|
| Female | Male | Contacts | Each |
| C11475 | C11471 | 4 | 18c |
| C11476 | C11472 | 5 | 18c |
| C11477 | C11473 | 6 | 18c |
| C11478 | C11474 | 7S | 18c |
| C11491 | C11490 | 8 Oct. | 21c |
| C11508 | C11506 | 9 | 23c |
| C11509 | C11507 | 11 | 28c |
- Miniature Connectors**
- (E) Molded bakelite connectors in cadmium plated brass shells. Only $1\frac{1}{8}$ " long, $\frac{1}{16}$ " diameter. Bakelite element held in place by set screw. When used with shielded cable, shield can be soldered to shell. Accommodates cables up to $\frac{3}{8}$ ".
- | | | | |
|--------|--------|-------|------|
| Male | Female | Cont. | Each |
| C13335 | C13337 | 3 | 21c |
| C13336 | C13339 | 4 | 24c |
| C13333 | C13334 | 5 | 26c |
| C13338 | C13340 | 6 | 26c |

- Side Opening**
- (B) Same as above but with side opening. $1\frac{1}{4}$ " D., $1\frac{1}{4}$ " L.
- | | | | |
|--------|--------|----------|------|
| Female | Male | Contacts | Each |
| C11586 | C11579 | 4 | 18c |
| C11587 | C11580 | 5 | 18c |
| C11588 | C11581 | 6 | 18c |
| C11589 | C11582 | 7S | 18c |
| C11590 | C11583 | 8 Oct. | 21c |
| C11591 | C11584 | 9 | 23c |
| C11592 | C11585 | 11 | 28c |

- Clamp Type**
- (C) Same as (A), but has positive gripping cable clamp. For cables up to $\frac{3}{16}$ " in diameter. Takes up cable pull and relieves soldered connections of strain.
- | | | | |
|--------|--------|----------|------|
| Female | Male | Contacts | Each |
| C11684 | C11692 | 4 | 22c |
| C11685 | C11693 | 5 | 22c |
| C11686 | C11694 | 6 | 22c |
| C11687 | C11695 | 7S | 22c |
| C11688 | C11696 | 7L | 22c |
| C11689 | C11697 | 8 Oct. | 24c |
| C11690 | C11698 | 9 | 26c |
| C11691 | C11699 | 11 | 31c |

- Shielded Sockets**
- (F) Similar to sockets listed as above but with shield. When used with shielded male connector listed above, a completely shielded connection is obtained. Easily mounted.
- | | | |
|--------|------------|-----------|
| No. | Type | Your Cost |
| C12704 | —3-contact | 21c |
| C12705 | —4-contact | 21c |
| C12706 | —5-contact | 24c |
| C12707 | —6-contact | 24c |

- Locking Covers**
- (D) For above connectors. $1\frac{1}{2}$ " x $2\frac{1}{2}$ ".
- C11479—Per Pair... 18c

MALLORY-Centralab SWITCHES

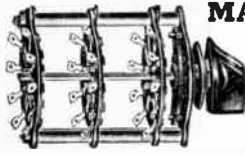

MALLORY Gang Switches

Contact members are heavily silver plated, and given a smooth hard finish. Contact shoe, of the self-cleaning type, is of silver alloy. All switches are provided with one permanent stop and one adjustable stop. Bushings $\frac{3}{8}$ " and extend $\frac{3}{8}$ ". Pointer type, Bakelite knob supplied.

SINGLE GANG SWITCHES

Shorting Stock No.	Type	Non-Shorting Stock No.	Type	Total No. Circuits	Points	Your Cost
C6247	1216L	C6263	1316L	1 Circuit	1 to 6 points	\$0.76
C6248	1211L	C6264	1311L	1 Circuit	1 to 11 points	.91
C6249	1215L	C6265	1315L	2 Circuit	1 to 5 points each	.97
C6250	1213L	C6266	1313L	3 Circuit	1 to 3 points each	1.06
C6251	1212L	C6267	1312L	4 Circuit	1 to 2 points each	1.12

TWO GANG SWITCHES

C6252	1226L	C6268	1326L	2 Circuit	1 to 6 points each	1.26
C6253	1221L	C6269	1321L	2 Circuit	1 to 11 points each	1.35
C6254	1225L	C6270	1325L	4 Circuit	1 to 5 points each	1.53
C6255	1223L	C6271	1323L	6 Circuit	1 to 3 points each	1.65
C6256	1222L	C6272	1322L	8 Circuit	1 to 2 points each	1.73

THREE GANG SWITCHES

C6257	1236L	C6273	1336L	3 Circuit	1 to 6 points each	1.71
C6258	1231L	C6274	1331L	3 Circuit	1 to 11 points each	1.82
C6259	1235L	C6275	1335L	6 Circuit	1 to 5 points each	1.94

FOUR GANG SWITCHES

C6260	1246L	C6276	1346L	4 Circuit	1 to 6 points each	2.12
C6261	1241L	C6277	1341L	4 Circuit	1 to 11 points each	2.32
C6262	1245L	C6278	1345L	8 Circuit	1 to 5 points each	2.70

SIX GANG SWITCHES

C6281	1261L	C6283	1361L	6 Circuit	1 to 11 points each	3.41
C6286	1266L	C6287	1366L	12 Circuit	1 to 6 points each	4.35



MALLORY Ceramic Switches

No.	Type	Gangs	Circuits	Each
C6642	161C	1	1	\$1.18
C6643	162C	2	2	1.76
C6644	163C	3	3	2.35
C6645	164C	4	4	2.94
C6646	165C	5	5	3.67

Low loss ceramic insulation, wide contact spacing, improved heavy silver plated contacts. For transmitters with power up to 100 watts. 4 contacts per circ. With knob.

C6647—Special dial plate for above. Numbered from 1 to 4.
Your Cost **12¢**
Each.

"3100" Series Single-Gang Tap and Circuit Selector Switches



Suitable for use in many types of test circuits. 2" notched shafts, $\frac{1}{2}$ " diam. With black bar knob and mounting nut, $\frac{3}{8}$ " bushings. Same features as gang switches (listed above). *—Have adjustable stop.

Shorting Stock No.	Type	Non-Shorting Stock No.	Type	No. of Circuits	Baso. Contacts Per Circuit	Baso. Diam.	Cost
C6878	3115J	C6888	3215J	One	5	1 1/2"	\$0.68
C6879	3112J	C6889	3212J	One	12	1 1/2"	.68
C6890	3122J	C6890	3222J	Two	2	1 1/2"	.68
C6891	3123J	C6891	3223J	Two	3	1 1/2"	.68
C6880	3126J	C6892	3226J	Two	6	1 1/2"	.68
C6881	3134J	C6893	3234J	Three	4	1 1/2"	.71
C6882	3142J	C6894	3242J	Four	2	1 1/2"	.71
C6883	3143J	C6895	3243J	Four	3	1 1/2"	.71
C6884*	31117J	C6896*	32117J	One	17	1 1/2"	1.06
C6885*	3129J	C6897*	3229J	Two	9	1 1/2"	1.06
C6886*	3136J	C6898*	3236J	Three	6	1 1/2"	1.15
C6887*	3163J	C6899*	3263J	Six	3	1 1/2"	1.15

Special Switches

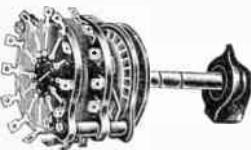

No. 1400L—12 positions; opens one line at a time while maintaining circuit through others. $1\frac{1}{2}$ " x $2\frac{3}{8}$ " wide. $\frac{3}{8}$ " bushing. 2" notched shaft. With knob and dial plate.
C6370—Your Cost **\$3.47**

24 Point Tap Switch

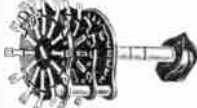

Special single-circuit, 24-point non-shorting switch. $\frac{3}{8}$ " bushing, 2" grooved shaft. Complete with dial plate and bar-type knob.
C6371—
Your Cost **\$2.06**

CONCORD can furnish Mallory or Centralab switches to fit any specification or applications. Write us your requirements.

MALLORY Push Button Switches

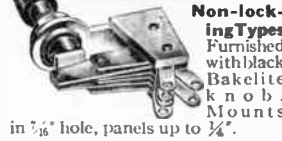

Non-locking Types
Furnished with black Bakelite knob. Mounts in $\frac{7}{16}$ " hole, panels up to $\frac{1}{4}$ ".
Stock
No. Type Contacts Your Cost
C6460 2001 SPST no \$0.76
C6461 2002 SPST nc .76
C6462 2003 SPDT .82
C6457 2004 DPST no .94
C6463 2006 DPDT 1.15

Midget Jack Switches

Same general construction as Junior types. Mount in $\frac{1}{8}$ " hole. Include black knob and pointer.
C6446—No. 10. S.P.S.T.
Your Cost **38¢**
No. 11—S.P.D.T. **51¢**
C6447—Your Cost



MALLORY Junior Jack Switches

Furnished with black knob; on-off plate. Mounts in $\frac{1}{8}$ " hole. Panels up to $\frac{1}{4}$ " thick. $\frac{1}{2}$ " deep.
Two Position Switches
No. Part Type Each
C6470 720 S.P.S.T. \$0.65
C6471 730 S.P.D.T. .79
C6472 740 D.P.S.T. .88
C6473 745 5-Spring 1.03
C6474 760 D.P.D.T. 1.15
C6475 733 3-P.S.T. 1.15
C6469 744 4-P.S.T. 1.50

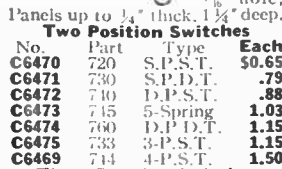

Three Position Switches (Center Position Off)
C6440 732 S.P.D.T. .67
C6441 762 D.P.D.T. .93
C6442 763 3-P.D.T. 1.22
C6443 764 4-P.D.T. 1.51

CENTRALAB Momentary Push Switches



For many light duty applications such as meter insertion, test equipment, etc. Rated 1 amp. at 110 v. a.c. Silvered contacts. Insulated $\frac{3}{8}$ " bushing, $\frac{3}{8}$ " long. Button extends $\frac{1}{2}$ " from end of bushing. Available with contacts normally closed or open.

C12867—Normally open
C12862—Normally closed
Either Type, Your Cost, Each **29¢**

CENTRALAB Tone Switches

Rotary Action
Shorting type: have $\frac{3}{4}$ " dia. bushing with $\frac{1}{2}$ " insulated steel shaft, $2\frac{1}{4}$ " long. No knobs or plates.
Stock No. Description Each
C12768* S.P. 2 pos. 44¢
C12769* S.P. 3 pos. 44¢
C12770* D.P. 2 pos. 44¢
C12820* D.P. 3 pos. 59¢
C12771* S.P. 2 pos. 44¢
C12772* D.P. 2 pos. 59¢
C12807 S.P. 4 pos. 44¢
Line Sw. S.P. S.T. 73¢
*Pos. Action. †Spring Return.

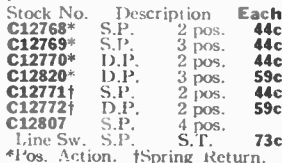

MALLORY Etched Plates

Hard aluminum with numbers etched in white. Fit $\frac{3}{8}$ " bushings. Plates with on-off position for use with switches. 30° spacing for all switch types 1200L, 1300L and 1 1/4" base 3100J and 3200J. 20° spacing for all type 3100J, 3200J switches with 1 1/4" base.



Marking	Stk. No.	30° Spacing 20° Spacing	Stk. No.
1 to 2	C6224		
1 to 3	C6225		C6303
1 to 4	C6226		C6304
1 to 5	C6227		C6305
1 to 6	C6228		C6306
1 to 7	C6229		C6307
1 to 8	C6230		C6308
1 to 9	C6231		C6309
1 to 10	C6232		C6310
1 to 11	C6233		C6311
1 to 12	C6234		C6312
1 to 15			C6243
Volume	C6244		
Off-1 to 3	C6235		C6313
Off-1 to 4	C6236		C6314
Off-1 to 5	C6237		C6315
Off-1 to 6	C6238		C6316
Off-1 to 7	C6239		C6317
Off-1 to 8	C6240		C6318
Off-1 to 9	C6241		C6319
Off-1 to 10	C6242		C6320
Any Type—Your Cost			12¢
C6223 Marked "0-100"			Each 15¢

MALLORY Hamswitch

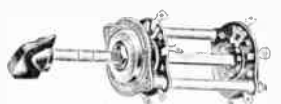

Provides means of using a single meter to measure currents or voltages in live transmitter circuits. High insulation factor and low loss construction. Conservative rating of 1000 volts RMS AC or 1500 volts DC. Two gang with $2\frac{1}{2}$ " spacing between sections. 2" grooved shaft. $\frac{3}{4}$ " bushing.
C6372—Your Cost **\$1.62**
C6374—Dial Plate, 1-5. 60° markings. **12¢**

CENTRALAB "Positive" & "Spring Return" Switches

Lever Action
Each switch supplied with knob. Plates available for mounting singly or in groups up to five.

Shorting No.	Type	Non-Shorting No.	Type
C12825	2 3 Positive	C12799	
C12826	2 3 Spring	C12800	
C12801	4 2 Spring	C12802	
C12804	2 3 Positive	C12803	
C12805	4 2 Pos. & Spr.	C12806	

Any Type Above, Each **73¢**

Mounting Plates

No.	Gangs	Dimen.	Each
C12794	1	2 1/2" x 3 1/2"	21¢
C12795	2	1 1/2" x 3 1/2"	24¢
C12796	3	2 1/2" x 1 1/2"	29¢
C12797	4	3" x 2 1/4"	35¢
C12798	5	3 3/4" x 3"	44¢

Universal Fiat Switches

Compact, inexpensive. May be used in variety of ways ranging from single pole single throw to 4 pole double throw. Bakelite insulation, non-shorting teeth. Requires $\frac{3}{8}$ " depth for mounting. With $2\frac{1}{4}$ " shaft and bar knob.
C12764—
Your Cost **59¢**
C12773—With spring return. Your Cost **73¢**



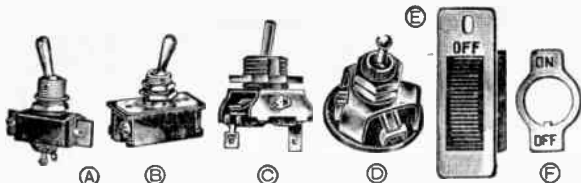

CUTLER-HAMMER SWITCHES

Approved type with nickel plated metal parts. New design. Fast action. Excellent for appliances, radio receivers, etc. Approved by Underwriters. Buy in quantity and save.

Stock No.	Fig.	Poles	Stem Length	Power		2-9 10-20 21-40			
				Amp.	Volt	Each	Each	Each	Each
C12836	A	SPST	1 1/2"	3	250	\$0.39	\$0.27	\$0.24	\$0.22
C13834	A	SPDT	1 1/2"	3	125	.49	.34	.29	.27
C12833	A	DPDT	1 1/2"	3	250	.93	.66	.56	.51
C12817	A	DPST	1 1/2"	3	250	.88	.62	.53	.49
C12813	B	SPST	1 1/2"	6	250	.98	.69	.59	.54
C12814	B	DPST	1 1/2"	5	250	1.03	.72	.62	.57
C12815	B	SPST	1 1/2"	10	250	1.57	1.10	.94	.86
C12816	B	DPST	1 1/2"	10	250	1.71	1.20	1.03	.94
C12837	C	SPST	1 1/2"	3	125*	.44	.31	.26	.24
C12832	D	SPST†	1 1/2"	3	125*	.44	.31	.26	.24
C12831	E	SP3T†	1 1/2"	3	125*	1.71	1.20	1.03	.94
C12841	F	SPST	1 1/2"	6	125	.78	.55	.47	.43

*Rated AC. †With dead center position.

Ⓕ On-Off switch plates for toggle switches. With locating projection. Marked "on" and "off."

C12818—Your Cost..... **6 1/2¢**
10 For..... **38¢**

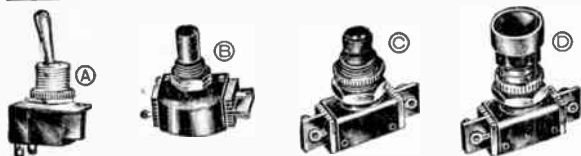

H and H SWITCHES

Ⓐ All have nickel metal parts, black finish.

Stock No.	Stem Length	Poles	Power		Each	Lots 10 Ea.
			Amp.	Volts		
C12754	1 1/2"	SPST	6	125	25c	\$2.25
C12755	1 1/2"	SPDT	3	125	30c	2.70
C12756	1 1/2"	DPST	5	125	48c	4.32
C12757	1 1/2"	DPDT	3	125	50c	4.50

H. & H. Rotary Panel Switches

Ⓑ Rated 3 amps., 125 volts. Approved type. With locknuts. Shaft extends 1". Bushing 3/8" in diameter. With lug terminals.

No.	Type	Each 10 For	No.	Type	Each 10 For
C12779	S.P.S.T.†	25c \$2.25	C12782	D.P.S.T.*	57c \$5.13
C12693	S.P.D.T.†	32c 2.88	C12783	D.P.D.T.*	51c 4.59
C12780	S.P.S.T.†	32c 2.88	C12784	D.P.D.T.*	58c 5.22
C12781	D.P.S.T.	47c 4.23			

*Bushings extends 1". Others, 3/8". †3 amp, 250 volt.

H & H Two Circuit Push Switches

In normal position, with plunger out, one circuit is "on," and the other "off." When plunger is depressed, circuits are reversed. Slow make, quick break momentary contacts. Rated 1 amp. at 125 v. a. c. Bushing 1 1/2" dia., 3/8" long.

METAL PLUNGER (C)

Used on Supreme instruments and other popular makes.

C12774—Your Cost..... **42¢**
10 For..... **\$3.78**

BAKELITE TIP (C)

C12777—Red } **55¢** 10 For **\$4.95**
C12778—Black } Each

BAKELITE BUTTON (D)

C12775—Red } **50¢** 10 For **\$4.50**
C12776—Black } Each

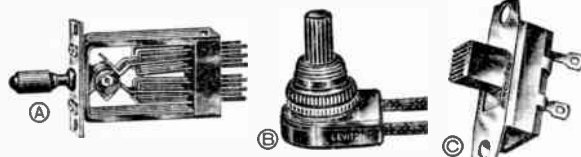

FEDERAL Anti-Capacity Switches

Ⓐ Springs are phosphor bronze silverplated, actuated by a cam roller. Stock No. Type Your Cost Stock No. Type Your Cost
C12852 D.P.S.T. } **\$1.90** C12850 4-P.D.T. } **\$2.25**
C12851 D.P.D.T. }

Canopy Switch

Ⓑ Rotary type, composition top. Very shallow. Wire leads. Rated 3 amp. at 125 volts.
C13342—Each..... **16¢**

Slide Switches

Ⓒ Compact slide silver plated switches in cadmium plated steel housings. All rates at 125 V. AC-DC. 1 1/8" mtg. ctrs.
No. Type Amp. Term. Ea. No. Type Amp. Term. Ea.
C12482 SPST .75 2 16c C12844 DPST .50 4 22c
C12483 SPDT .75 3 19c C12840 DPDT .50 6 28c

ALL PURPOSE SWITCHES

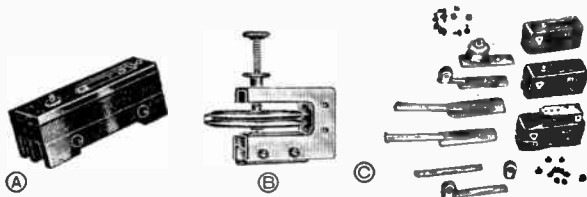

Standard MU-Switch

Ⓐ Light pressure, quick action precision units. Require only 4 oz. pressure and .001" of movement to operate. Underwriters approved. Rated 15 amps. at 125 volts a.c.; 1/2 H.P. inductive loads at 125-160 v. a.c. Bakelite case 1 1/8" x 1 1/8" x 1 1/8" high. Screw terminals with lugs. Used for sorters, counters, float controls, etc.

No. Type Normal Each
C12725 S.P.S.T. Closed **90¢**
C12726 S.P.S.T. Open }
C12727 S.P.D.T. } **\$1.08**

Thermostat-Type MU-Switch

Ⓑ For automatic control of temperature in electrically heated brooders and incubators, or wherever an automatic electric heat control is desired. Maximum efficiency between 80° and 120° F. Has double ether-filled wafer and adjusting screw. Rated 15 amps. 125 v.; 5 amps. 250 v. A.C. only. Non-inductive loads.

C12753—Your Cost..... **\$1.35**

UNIMAX Design Kit

Ⓒ For the designer and model maker. Design kit enables quick selection of precision switch types necessary to suit a particular requirement. Fills many needs in the drafting room, model shop and maintenance department by making available diversified switch types for quick determination of size, shape, mounting and method of actuating, best suited for a particular application. Kit complete with two MX-1 SPDT base switches, one MX T-1 base switch with direct acting hinge arm. Adaptaplates, one style "J" spring plunger with threaded bushing for one-hole panel mounting, one style "W" leaf spring with steel roller, two style "L" standard leaf springs, one style "T" direct acting with leaf, one style "R" direct acting with roller, roller assembly to fit styles "L" and "T" adaptaplates. Screws and rivets for attaching adaptaplates.

C12758—Your Cost..... **\$2.75**

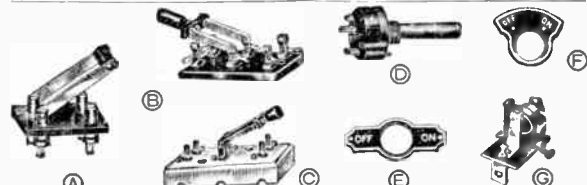

Midget Knife Switches

Ⓐ Panel mounting. Have black bakelite bases, plated metal parts. Single pole types 1 1/4" long, 1/2" wide; double pole 1 1/4" long, 1" wide. With mtg. nuts.

Your Cost Each
No. Type
C16842 S.P.S.T. 19c
C16843 S.P.D.T. 32c
C16845 D.P.S.T. 38c
C16844 D.P.D.T. 40c

Bakelite Knife Switches

Ⓑ Heavily plated metal parts, bakelite base. Single pole types 1 1/8" long; double pole 2 1/8" long.

Stock No. Type Your Cost
C16830 S.P.S.T. 50c
C16831 S.P.D.T. 59c
C16832 D.P.S.T. 68c
C16833 D.P.D.T. 79c
C16834 3-P.S.T. 51.09
C16835 3-P.D.T. 1.18
C16836 4-P.S.T. 1.47
C16837 4-P.D.T. 1.76

Porcelain Base Knife Switches

Ⓒ Especially suitable for aerial and ground. Copper contacts and blades.

Stock No. Type Your Cost
C16820 S.P.S.T. 13c
C16821 S.P.D.T. 16c
C16822 D.P.S.T. 23c
C16823 D.P.D.T. 27c
C16825 3-P.D.T. 53c

CLAROSTAT Rotary Switches

Ⓓ Compact, positive contact Underwriters' Approved Switches. Bakelite molded construction. Rated 1 amp., 250 volts; 3 amps., 125 volts. 1 1/2" diam., 9/16" body depth; bushings are 3/8" diam., 1 1/2" shaft.

Your Cost Each
No. Description
C12845 S.P.—S.T. 35c
C12846 D.P.—S.T. 44c
C12847 S.P.—D.T. 44c
C12848 4-Wire, S.T. 44c

Rotary Switch Plate

Ⓔ "Off-On" switch plate. Etched aluminum and black. Size: 1x1 1/2". Clean cut lettering. C9857—10 for 65¢
Your Cost Each..... **7¢**

Switch Plate

Ⓕ "Off-On" switch plate. Etched aluminum and black. Size: 1 1/8" x 1 1/8". C9859—10 for 65¢
Your Cost Each..... **7¢**

Bias Cells

Ⓖ 1 and 1 1/4 volt types. For biasing high-gain amplifiers. C6419—1 volt.
C6424—1 1/4 volt.
Your Cost Each..... **24¢**

Holders Only for Above

C6420—For 1 Cell..... 9c
C6421—For 2 Cells..... 15c
C6422—For 3 Cells..... 21c
C6423—For 4 Cells..... 24c

DIALS Variable Condensers

CROFLEX Tuners and Calibrations

Choose for size alone because flexibility of these new tuners adapts them to any normal chassis. Condenser may be clockwise or counter-clockwise and may be located in various positions relative to the tuner. Each tuner permits choice of 5 different knob locations. Stock calibrations listed below permit horizontal or vertical mounting of the tuner. All models have attractive "3-dimension" edgelighted glass dial scales and genuine antiqued bronze escutcheons. The smallest size has one lamp socket; the other three models furnish two sockets. Hubs are all $\frac{3}{8}$ " with $\frac{1}{4}$ " adapters. All supplied with horizontal double-channel calibrations, broadcast-band 55 to 170 and short-wave 6 to 18, with low numbers at left, but the largest model, No. 234, has a third scale reading reverse, arbitrary 0 to 100. Dial scales are brown background to harmonize with any cabinet.

Model	Escutcheon	Panel	Pointer	Stock	Your
	Overall	Cutout	Travel	No.	Cost
(A) 231	$2\frac{1}{2} \times 4\frac{3}{8}$ "	$1\frac{7}{8} \times 1\frac{1}{2}$ "	$3\frac{1}{2}$ "	C9818	\$2.50
(B) 232	$2\frac{9}{16} \times 6\frac{1}{8}$ "	$1\frac{1}{2} \times 5\frac{1}{2}$ "	$4\frac{1}{2}$ "	C9819	2.65
(C) 233	$3\frac{3}{8} \times 6\frac{1}{8}$ "	$2\frac{1}{4} \times 6\frac{1}{8}$ "	$5\frac{1}{2}$ "	C9820	2.79
(D) 234	$3\frac{1}{16} \times 8\frac{7}{16}$ "	$2\frac{3}{16} \times 7\frac{1}{16}$ "	$6\frac{3}{4}$ "	C9821	2.94

Stock Calibrations: The glass dial scales may be removed and replacements put in easily.

Model	AM Broadcast & Short-wave, double channel		AM Broadcast only, single channel	
	Horizontal	Vertical	Horizontal	Vertical
231	+	C9822	C9826	C9830
232	+	C9823	C9827	C9831
233	+	C9824	C9828	C9832
234	+	C9825	C9829	C9833

†—All Horizontals supplied with respective dials.

‡—Stock calibrations as above.

Your Cost Each **4.4¢**

Permeability Tuners and Dials

Complete assembly, includes dial, coils, knob shaft, cable, slug carriage, two High Q slugs, and clear plastic dial cover. Tunes RF and Oscillator coils by moving the slugs in and out of the cores as the knob shaft is turned. Highly efficient superheterodyne circuit component, carefully pre-tracked at the factory, ready to install and operate. Fool proof, retains alignment. Complete with wiring diagram and instructions. Use as the basis for ultra-compact receivers, no tuning gang capacitor needed. Smooth dial drive; handsome gold, buff and brown finished dial scale. Covers 540 to 1600 kc.

- (E) C10451—With slide rule dial and window. **Your Cost \$4.05**
- (F) C10450—With rectangular dial. **Your Cost \$2.85**

CRO-BAND Dial

(G) Escutcheon opening measures $1\frac{7}{8} \times 7\frac{1}{4}$ " with Croglas crystal and antique bronze finish. For use with $\frac{3}{8}$ " or $\frac{1}{2}$ " shafts. Pilot light sockets furnished. For counter-clockwise condensers. **Your Cost \$3.53**

Slide Rule Dials

(H) In both $\frac{1}{4}$ " and $\frac{3}{8}$ " shafts. For close right or close left condensers. Panel opening required: $1\frac{1}{4} \times 5\frac{1}{8}$ ". Universal scale for broadcast and short-wave.

- C9812—Counter-clockwise.
- C9811—Clockwise.
- Either Type \$2.06**
- Similar to above but smaller. Requires $1\frac{1}{8} \times 3\frac{1}{8}$ " opening.
- C9817—Counter clockwise.
- C9816—Clockwise.
- Either Type \$1.71**



Midget Condensers

- (J) For communications receivers and transmitters. Compact, rugged and highly efficient. Ceramic insulation, sturdy lug terminals, single hole mounting feature, etc. $\frac{1}{4}$ " shaft plated to resist corrosion. With mounting nut. Shpg. wt. 1 lb.
- C9728—Capacity 3.5 to 25 mmfd. 4 plates. **Each 76¢**
- C9731—Capacity 6 to 80 mmfd. 11 plates. **Each 88¢**
- C9727—Capacity 6 to 100 mmfd. 14 plates. **Each 94¢**
- C9714—Capacity 7 to 110 mmfd. 19 plates. **Each \$1.03**

Midget Single Gang Condensers

- (K) With all the features and characteristics of larger units. Ideal for limited space apparatus. Rotor and stator plates, firmly staked into position. Low-loss bakelite insulation. Improved ball bearing. Counter-clockwise rotation for all types. $\frac{1}{4}$ " shafts. $1\frac{3}{4} \times 1\frac{3}{4} \times 1\frac{1}{16}$ " deep. Less trimmers. Wt. 1 lb.

No.	Mmfd.	Each	No.	Mmfd.	Each	No.	Mmfd.	Each
C10189*	15		C10193*	75		C10198	410	
C10190*	25	49¢	C10194	100		C10199	450	49¢
C10191*	35		C10195	150				
C10192*	50		C10196	250				

*—Double spaced.

DEFIANCE Gang Condensers

(N) All feature aluminum plates, ball bearing rotors and low-loss insulation. Two and three gang units supplied with trimmers on the bottom. Shafts $\frac{1}{4}$ " dia., $1\frac{1}{4}$ " long. Three mounting holes tapped for 6/32 screws. All $1\frac{3}{8}$ " high, $1\frac{1}{8}$ " wide. Shpg. wt. 1 lb. All 365 mmfd. per section except cut sections on 456 Kc Super types.

No.	Each	Gangs	Length	Rotation	456 Kc Super
C9780	\$0.59	1	$1\frac{1}{8}$ "	counter-clock	No. C9798
C9781	1.19	2	$2\frac{1}{8}$ "	counter-clock	C9799
C9782	1.65	3	$3\frac{1}{8}$ "	counter-clock	C9799
C9783	.59	1	$1\frac{1}{8}$ "	clockwise	C9796
C9784	1.19	2	$2\frac{1}{8}$ "	clockwise	C9796
C9785	1.65	3	$3\frac{1}{8}$ "	clockwise	C9797

420-160 mmfd Defiance Gang Condensers

Two gang, 420, and 160 mmfd. condensers for use with 456 KC IF superhets. Counter-clockwise rotation, with trimmers built onto frame. Total length $2\frac{3}{16}$ ". Shpg. wt. 1 lb.

- C9775—Two Gang, 420 and 160 mmfd. **\$1.19**
- C9776—Three Gang, Two 420 and one 160 mmfd. **1.65**

NEW! Gang Condensers for FM and FM-AM

Four new Defiance models for modern sets. Each section has a trimmer. Aluminum plates, ball-bearings, low-loss insulation, $\frac{1}{4}$ " shafts.

- (L) **FM-AM 5-Section:** Ranges shown are in mmf. FM front section, 19.1-1.4. FM center section, 18.5-1.2. FM rear section, 18.5-1.3. AM RF section, 421-31.6 AM oscillator section, 161.6-21.1. **Your Cost \$1.95**
- FM-AM 4-Section:** Ranges shown are in mmf. Two FM sections, each 18.5-1.2. AM RF section, 420 maximum. AM oscillator section, 162 maximum. **Your Cost \$1.65**
- (M) **FM 3-Section:** Each section 14.8-1.3 mmf. **Your Cost \$1.25**
- FM 2-Section:** Each section 14.8-1.3 mmf. **Your Cost 95¢**

Shaft Couplings and Bushings

- (P) Well-made brass bushings that have many applications.

1 (Coupler)	2 (Extender)
Sizes	Fig. Stock No.
$\frac{1}{8} \times \frac{1}{4}$ "	1 C15014 C15000
$\frac{3}{16} \times \frac{1}{2}$ "	1 C15006 C15001
$\frac{1}{2} \times \frac{1}{2}$ "	1 C15008 C15002
$\frac{1}{2} \times \frac{3}{4}$ "	1 C15017 C15004
$\frac{3}{4} \times \frac{1}{2}$ "	2 C15018 C15005
$\frac{3}{4} \times \frac{3}{4}$ "	2 C15009 C15003

Your Cost, Any Type \$1.08

Split Bushing

Type 3. For increasing shaft dia. from $\frac{1}{4}$ " to $\frac{3}{8}$ ". Brass, $\frac{7}{16}$ " long. **Your Cost Each 6¢**

Panel Bearing Assembly

- (R) Use with rigid or flexible coupling when mounting. For up to $\frac{3}{16}$ " panels.

No.	Size	Each
C9563	3" long, $\frac{3}{4}$ " Shaft	21¢
C9562	6" long, $\frac{3}{4}$ " Shaft	28¢
C9564	Bearing only	5¢

Brass and Fibre Shaftings

- Fine for extensions. $\frac{1}{4}$ " dia.
- C15010—6" Brass **12¢**
- C15011—6" Fibre. **Your Cost 12¢**
- C15012—12" Brass. **Your Cost 24¢**
- C15013—12" Fibre. **Your Cost 24¢**

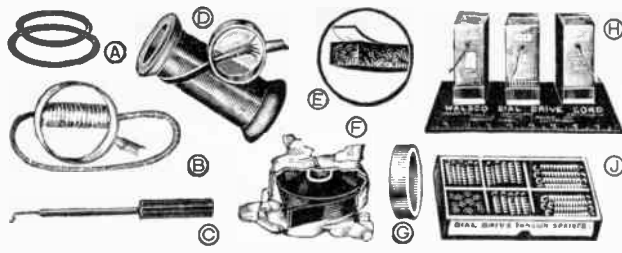

DIAL CABLE AND FUSES

Linen Dial Cable

All four types of dial cable of black woven linen. To be used as exact replacement in most receivers. All have high tensile strength for long trouble-free service. Special thin .025" dia. Standard .031" dia. Medium .042" dia. Heavy .062" dia.

Special		Standard		Medium		Heavy		
Lgth.	Stock	Stock	Each	Stock	Each	Stock	Each	
25 ft.	Env.* C9930	\$0.24	C9943	\$0.65	C9931	\$0.24	C9932	\$0.24
100 ft.	C9889	.53	C9944	2.06	C9928	.73	C9940	.83
	C9927	1.68	C9944	2.06	C9929	2.57	C9882	2.70

*Special Thin 13 1/2', Medium 8 1/2', Heavy 8'

A JFD WOVEN FABRIC DIAL BELTS

Best quality belts that will not stretch or slip. **IMPORTANT!** Order by Stock No. and Give Belt No.

Cut Lgth.	Belt No.	Cut Lgth.	Belt No.	Cut Lgth.	Belt No.	Cut Lgth.	Belt No.
6 1/2"	1	8 1/2"	53	11"	29	13 1/2"	75
6 1/2"	58	8 1/2"	60	11"	79	13 1/2"	46
7 1/2"	2	9"	84	11 1/2"	32	14 1/2"	47
7 1/2"	61	9 1/2"	76	11 1/2"	65	14 1/2"	83
7 1/2"	57	9 1/2"	80	11 1/2"	30	15 1/2"	48
7 1/2"	56	9 1/2"	15	11 1/2"	31	15 1/2"	49
7 1/2"	5	9 1/2"	63	11 1/2"	34	15 1/2"	86
7 1/2"	5	9 1/2"	16	11 1/2"	36	16"	85
7 1/2"	55	10"	19	12 1/2"	43	16 1/2"	87
8"	88	10 1/2"	66	12 1/2"	41	16 1/2"	50
8 1/2"	11	10 1/2"	27	12 1/2"	38	16 1/2"	51
8 1/2"	4	10 1/2"	26	12 1/2"	54	17"	89
8 1/2"	59	10 1/2"	24	12 1/2"	67	17 1/2"	68
8 1/2"	72	10 1/2"	64	12 1/2"	40	17 1/2"	81
8 1/2"	14	10 1/2"	22	12 1/2"	39	18 1/2"	82
8 1/2"	10	10 1/2"	52	12 1/2"	44	19 1/2"	90
8 1/2"	8	10 1/2"	20	12 1/2"	45	21 1/2"	73
8 1/2"	13	10 1/2"	21	13 1/2"	77	22 1/2"	74

C9909—SPECIFY BELT No. Your Cost Each.....15c

Detrola Drive Springs

Exact replacements for 1946-47 Detrola-Utah Expansion spring with inserted core. C9893—Your Cost.....24¢

Dial Cable Adjuster

Handy aid for replacing slipped-off dial cable over dial drum. C15061—Your Cost.....44¢

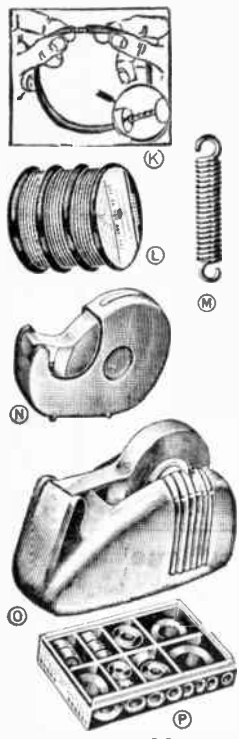

Drive Rubbers

Kit contains eight different types of friction drive rubbers for replacement in popular receivers including: Atwater Kent, RCA, and Stewart Warner. C9400—Kit of 24 pieces. Your Cost...88¢

WALSCO Thrifty Cord Rack

Contains 100 ft. each of medium, special thin, and standard dial cable on aluminum base. C9887—Your Cost.....\$5.22

Dial Drive Spring Assortment

Handy kit for servicemen. Box contains six different sizes of hard to get tension springs. Total of 25 springs in all. Offered at an unusually low price. Shpg. wt., 1 lb. C9892—Your Cost.....65¢

WALSCO Unibelt

Replacement for any dial belt. Cut to size—join ends with simple zipper-like connector. Breaking strength over 60 lbs. 5 ft. spool with 10 connectors. C9888—Your Cost.....\$1.47

Dial Cable Thrift Spool

Economical and practical assortment of dial cables. 3 section spool contains 15 ft. each of phosphor bronze cable, medium linen cord, and special thin cord. Shpg. wt., 1 lb. C9879—Your Cost.....\$1.18

Dial Drive Springs

High grade steel wire rust-proof springs. Five sizes take care of all requirements. C9890—Kit of 10 Ass't. Your Cost.....24¢
C9891—Kit of 10 small sizes. Your Cost.....24¢

Transparent Scotch Tape

C15046—1/4"x792".....Ea. 6 for 50c \$2.70
C15047—3/8"x792".....60c 3.24

Dispensers

C15033—Plastic hand dispenser. 1/2" tape. Your Cost.....29c
C15034—Plastic hand dispenser. 3/4" tape. Your Cost.....29c
C15035—Desk dispenser. Takes both sizes. Your Cost.....\$1.39

Phosphor Bronze Dial Cable

16 strand closely braided. 42 strand consists of seven 6 strand cables over linen core.

42	16				
Lgth.	Strand	Each	Strand	Each	
25 ft.	Env.*	C9925	\$0.24	C9926	\$0.24
100 ft.	C9934	.76	C9937	.55	
	C9872	2.73	C9881	2.03	

*42 strand 8 1/2', 16 strand 11 1/2'.

Rub-R-Shim

Strips of shockproof live sponge rubber. One side adhesive coated. 10-ft. rolls. No. W x T. Ea. 10 For
C14861 3/4"x2" 38c \$4.10
C14862 3/4"x3 1/2" 46c 4.95
C14863 3/8"x1 1/2" 52c 5.60

Friction Tape

Handy 3/4" wide rolls. Packed in individual boxes. C14829—2 Oz. Each...11c
C14842—4 Oz. Each...20c
C14843—8 Oz. Each...36c

Black Scotch Tape

For insulating or binding radio parts. Hi-adhesive quality. Very flexible, easy to remove. 3/4" wide. Roll is 360 inches long. Black color. C15039—Your Cost.....25¢

FUSES AND FUSE MOUNTINGS

Radio and Auto Fuses

Ⓡ Type 3-AG: Rated 250V. 1 1/4 x 1 1/4". Tins of 5. May be assorted for quantity price.
C13189—Specify Amperage.
1 Amp. Per 5 Per 100
2 " } 18¢ \$3.25
3 " }
5 " }
10 " }
15 " } 12¢ \$2.10
20 " }
25 " }
30 " }

LITTELFUSE Auto Fuses

Ⓡ Type 3-AG. Ratings are at 25 V. 1 1/4 x 1 1/4".
C12320—5 amps.....3c \$2.45
C12321—10 amps.....3c 1.96
C12322—15 amps.....3c 1.96
C12323—20 amps.....2c 1.71

Fuse Retainer

Ⓢ Two piece connector made of heavy metal, with heavy fibre inside insulation. Powerful spring contacts insure good connections. Length 2 1/2". C12372—Your Cost.....9¢
12 for.....97c

Bakelite Fuse Mounts

Ⓢ Sub-Panel Type. Molded bakelite. 1" 6-32 studs. For instrument fuses only. C12382—Each.....12¢
As above, but for 1 1/4 x 1 1/4" fuses (type 3AG). C12327—Each.....12c

Panel Type

Molded bakelite. 1 1/4 x 3/8 x 1 1/4". For 1" instrument type fuses only. Plated fuse clips. C12383—Your Cost.....9¢
Same as above, but for 1 1/4 x 1 1/4" fuses (type 3AG). C12324—Each.....15¢

LITTELFUSES For Radio Sets and Amplifiers

Ⓡ Type 3-AG. 1 1/4 x 1 1/4". Approved.
250 Volt
No. Amps. No. Amps.
C12378 1 C12396 3/4
C12379 1 1/2 C12397 1/2
C12380 2 C12398 1/2
C12381 3 C12399 1/2
Above, Each 4¢ Above, Each 9¢
100 for...\$3.43 100 for...\$7.35

Plug Fuses

Ⓢ For use in 110 volt house circuits.
C13200—6 amp. C13203—20 amp.
C13201—10 amp. C13204—30 amp.
C13202—15 amp.
Your Cost Each.....5¢

NITE-T-LITE

Ⓢ Soft neon glow ideal for all rooms in the house, stairways, hallways. Not intended for illumination. Provides ample light for orientation in the dark. Fits all standard plug-in outlets. Operates on AC or DC, up to 120 volts. Uses less than 1/10 watt. Neon bulb, sealed in clear molded plastic. Underwriters Listed. C12330 Your Cost.....25¢
Lots of 24 \$4.64

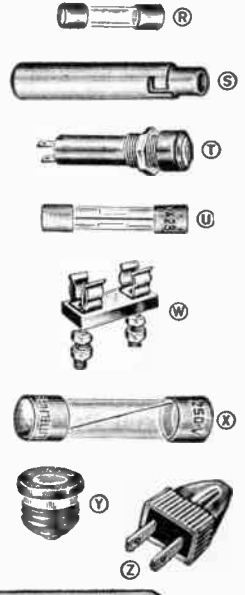

Ⓢ "Jumbo" Fuse Retainer
Replacement for Philco and Motorola radios. Complete with bushings, springs. 2 1/2" long by 1/2" dia. C8349—Your Cost.....17¢
12 for.....\$1.84

Extractor Fuse Posts

Ⓢ For use with 1" instrument type fuse only. Diameter 1/2". Bushing for panels up to 3/16" thick. C12328—Your Cost.....24¢
As above for 3AG fuses (1 1/4 x 1 1/4"). C12326—Your Cost.....24¢

RADIO for Beginners

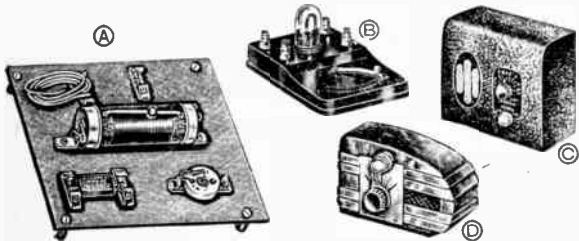

Radio Beginners Crystal Detector Kit

A Ready to assemble kit especially designed for beginners in radio. All radio parts necessary for assembly are included. No soldering or involved wiring techniques are required. Fahstock clips are provided for fastening wires to terminal points. Merely mount parts and clip wires to the points indicated by the large full size instructions that accompany each kit. Size when assembled is 7"x7 1/2"x2 1/2" high. Shpg. wt. 4 lbs. Includes all parts, wire, and extra sensitive silicon detector unit.

C13871—Your Cost **\$2.45**

SUPERTONE Crystal Set

B This Supertone Crystal Set is a big seller and there is plenty of good reason for its popularity. Remarkable results have been obtained and its scientific construction gives loud, clear, distortion free reception. A Super-sensitive crystal is utilized which is mounted in a glass dust-proof enclosure. Shpg. wt. 1 lb.

C13888 **\$1.12**

LITTLE WONDER: like above, but detector is not enclosed. Bakelite housing. Shpg. wt. 1 lb.

C13889—Your Cost **76¢**

SUPERTONE Radio Kit

B An interesting, educational, ready-to-assemble radio kit that is ideal for beginners. Includes molded bakelite base with contact slider, single headphone, and Super-Sensitive crystal as shown above. Complete directions for assembly and operation, as well as instructions for putting up the most effective antenna.

C13870—Your Cost **\$1.95**

TEE-NEE RADIO

★ No Batteries ★ No Tubes ★ No Current

C None of the fuss of batteries, tubes, or plugging into power lines, needs only an aerial and ground. Housed in a beautifully finished mahogany crackle finished steel case. Supplied complete with single headphone with head band, but less aerial and ground wires. Size 5 1/2"x4 1/4"x3". Shpg. wt. 1 1/2 lbs.

C13880—Model Crystal Set 250. **\$3.92**

Your Cost

TEE-NEE PLASTIC CASE RADIO

D Beautiful mahogany colored plastic case. Just like the big sets. Earphone sets into case when not in use. Remove the earphone from the case and hold close to the ear for good reception. Complete with single earphone, but less aerial and ground wire. Size 4"x2 1/2"x1 3/4". Shpg. wt. 1 lb.

C13881—Model 100 Crystal Set. Your Cost **\$2.36**



Glass-Enclosed Crystal Detector

E Dust-proof. An easily adjusted crystal unit equipped with a super-sensitive mineral and a cats whisker.

C13916—Each **26¢**

Crystal Detector

F Includes ball and socket swivel arm, crystal holder and mtg. hardware. Completely mounted as illustrated but less crystal. Crystal, base and clips not supplied.

C13903—Each **12¢**

Mounted crystal for above.

C13900—Each **6c**

Fixed Crystal Detector

G Super-sensitive point found by meters and fixed permanently. In Bakelite case with screw connections.

C13913—Your Cost **46¢**

Cat Whisker

H Finest wire—correct tension holds that sensitive spot.

C13921—Envelope of 3. Your Cost **9¢**

Super-Sensitive Crystal

J Gets more stations and gets them louder. Each crystal is meter tested after selection.

C13901—Each **12¢**

10 for **\$1.08**

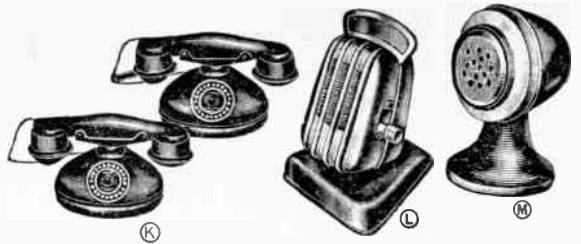

Marvel Phones

K Here is a new utility telephone system which provides an inexpensive method of establishing intercommunication in homes, offices, factories, farms, etc. Consists of two pressed metal cradle-type telephones connected by a single conductor cable 70 feet long. Requires two dry cells at each phone. The set will operate over much greater distances depending upon the number of batteries used (not furnished). Operated by merely pushing the "push-to-buzz" button and then lifting the hand phone to listen. Complete instructions and guarantee are included with each set. Wt. 3 lbs.

C14004 **\$7.95**

Your Cost

Lots of 3, Your Cost each **\$7.46**

C19858—Batteries for above. Each **35c**

Wireless Microphone

L Talk through your radio with no connecting wires! Tunes in like a regular broadcast station. With two units, radios may be used as intercommunication sets between various parts of the house.

75 ft. effective range. Tunes 1000 to 1700 KC by means of knob at side, assures a clear channel. Entirely self contained with power supplied by one flash light cell and a "Minimax" "B" battery. Extremely small form, due to use of single 1L4 tube. Measures 6 1/4" high, 5 1/4" deep, 5" base. Microphone silver-gray, base brown with protective rubber rim. With batteries and tube.

C22548— **\$6.63**

Your Cost

Model 500 Microphone

M Permanent magnet type mike equipped with 18 feet of cable. Bullet shape design finished in black and nickel. Has exceptional capabilities for amplifying sound with minimum distortion and maximum fidelity. Size 1x3x3 inches. Shpg. wt. 9 oz.

C13380— **\$2.21**

Your Cost

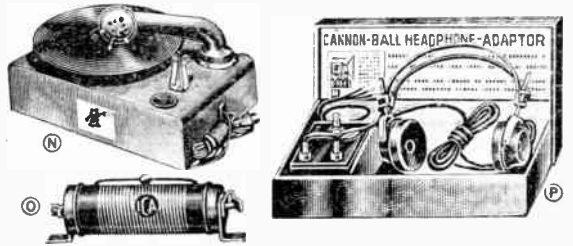

Phonograph Model 1000

N A newly engineered Carron phonograph with a mechanical reproducer. Eliminates the necessity for using radio tubes, and is of an improved type with a greater range and volume. Has a constant speed motor that operates on 110 volts, 60 cycles, and plays records up to 12" in size. The balanced tone arm keeps excessive weight off the records and permits smoother playing—longer record life. Incorporates a tone chamber that amplifies and rounds out the sound. Motor is enclosed in a metal case finished in baked enamel with a decorative decal. An ideal gift for children. Size 13x9x3". Shpg. wt. 9 lbs.

C22655— **\$7.85**

Your Cost

ICA 3-in-1 Radio Tuner

O Antenna tuner, wave trap, aerial eliminator all in this one instrument, depending on the manner of its connections to the radio set; greatly enhancing radio performance. Operates on any make or model radio set. Can be installed by anyone in a few minutes.

C12678— **59¢**

Your Cost

10 for **\$5.31**

Headphone Kit

P When installed, the user can enjoy choice of headphone reception only, speaker reception only, or both together. Complete outfit consists of: 18" connecting cable, adaptor with three-way switch and terminal jacks on an insulated panel, special Reliance phones with 6-ft. cord and complete installation instructions. Shpg. wt. 3 lbs.

C13944— **\$2.61**

Your Cost

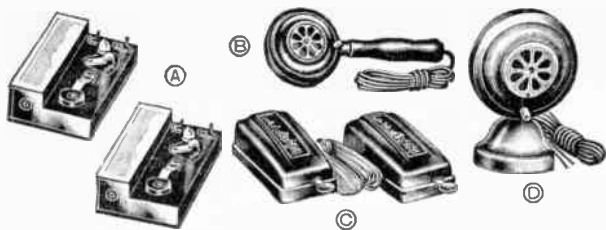

"Western Union" Telegraph Set

★ It Buzzes! Flashes, Clicks

(A) Consists of two "WESTERN UNION" telegraph signal units. Easy to connect and operate. You can learn how to send and receive telegraph code messages. Space is provided for two standard flashlight batteries in each case (batteries not supplied).

C14007—(Less Batteries) **65¢**
Your Cost.....
C20622—Battery, Each..... 6½¢

Hand Microphone

(B) A real hand microphone. Works with any set using a loudspeaker. Does not interfere with reception. Push button switch permits reception or use of mike at will. Handsomely finished.

C13831—Your Cost..... **88¢**

3-Way Telegraph Set

(C) Ideal educational toy. Two-station set with 100 ft. connecting wire. International Morse Code engraved in top of each set. Key with professional "feel." Switch selects choice of light blinker, buzzer, or railroad-type clacker. Buzzer is built in. Headsets may be attached if desired. Blinker-light for line-of-sight transmission is self contained. With instruction booklet.

C14003—**\$4.80**
Your Cost.....

"MIKE" Jr.

(D) A real radio microphone easily attached to any radio. Great for home entertainment but also has practical uses for voice students, etc. In brown finished metal case with attachment cord. Has a push switch to cut out radio whenever desired. Shpg. wt. 1 lb.

C13379—Your Cost, only..... **59¢**

RADIO KITS TRAINING SETS

CONNECTICUT

Duplex Telephone Set

★ For Home, Business, Play



Handsome green finished all metal phone cases with built-in bell ringers and black bakelite mouthpieces. Separate earphone with black bakelite earpiece. Perfectly safe! Uses two ordinary No. 6 dry cells at each station for lines up to 1000 feet long. Longer lines up to 2000 ft. in length may be run by adding more batteries. Ideal for house to garage, basement to upstairs, farm-house to out-buildings. Complete with 160 feet of 19-gauge white plastic insulated copper line wire, two phone stations and necessary hardware for wall mounting. Batteries not furnished.

C14002—Per Set **\$9.30**
Your Cost.....
 Batteries for above. **35¢**
C19858—Each, Your Cost.....

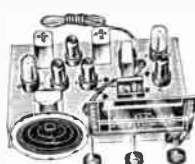
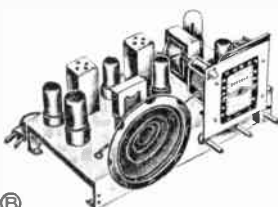
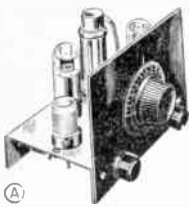

MEISSNER RADIO KITS

★ Ideal for Elementary Radio Training!

★ Easy to Construct—Simple to Operate!

★ Enjoy Building, Learning, Using!

(A) Easy-to-build Regenerative sets designed for Radio Students. With complete instructions and plug-in coil for Broadcast band (180 to 550 Meters).

Two Tube AC-DC Receiver. Uses one 76 tube as a detector and one 76 tube as a rectifier. Operates from any 110 volt AC or DC supply. Supplied less tubes and headphones.

C10441—Your Cost..... **\$5.29**

Three Tube AC-DC Receiver. Uses one 76 tube as a detector, one 76 tube as audio, and one 76 tube as rectifier. Operates from any 110 volt AC or DC supply. Supplied less tubes and headphones.

C10442—**\$6.03**
Your Cost.....

Accessories

C10422—17 to 35 Meter Plug-in Coil..... } **Each 49¢**
C10421—35 to 70 Meter Plug-in Coil..... }
C10420—70 to 200 Meter Plug-in Coil..... }
C10423—5.15 to 1500 Meter (Long Wave) Coil. Your Cost..... **\$1.23**

6-Tube Two-Band Superhet Kit

(B) Dial calibrated to cover broadcast band of from 550 to 1600 kilocycles and shortwave band from 6 to 18 megacycles. Tuning control, Band switch, and volume control, with built-in On-Off switch conveniently grouped beneath square illuminated dial. Untuned stage of RF amplification on both bands. Peaking circuit for added sensitivity on short wave. Filter choke for hum free operation at maximum output. Has 12SK7 RF amplifier, 12SA7 converter, 12SK7 IF amplifier, 12SQ7 Detector, AVC, 1st Audio, 35L6GT Power Amplifier and 35Z5GT Rectifier. Kit includes all parts needed for completion of the receiver. Detailed step-by-step instructions are included to facilitate construction. 6-Tube 2-Band Kit, complete with tubes and speaker.

C24459—Your Cost..... **\$24.70**

5-Tube AC-DC Superhet

(C) Frequency range 540 to 1600 KC. All parts necessary to complete set and including tubes and speaker. Factory wound loop, 2 gang tuning condensers, 2 double tuned IF transformers, and attractive accurately calibrated dial. 12SA7 mixer-oscillator, 12SK7 IF, 12SQ7GT detector-1st audio, 50L6GT beam power output, and 35Z5GT rectifier. 110 V AC-DC operation. Instructions included.

C24458—Your Cost..... **\$20.20**

6- and 8-Tube AC-DC Superhet Kits

Long Wave—Broadcast Band—Short Wave

(D) Highly sensitive sets with RF stage for all bands in all models. Easy to assemble. Instructions are complete with both pictorial and schematic diagrams. Chassis is punched, formed, and cadmium plated. No holes to drill. No dial to mark. Only screwdriver, pliers and soldering iron needed. Coils pretuned and impregnated. All tubes and components are standard brand name parts. All models are for AC or DC, 105-125 volts.

6-Tube Kit, Two Bands, 550-1600 kc and 5.5-18.0 mc.
C24451—**\$24.75**
Your Cost.....

6-Tube Kit, Two Bands, 140-425 kc and 550-1600 kc.
C24452—**\$24.75**
Your Cost.....

Both 8-Tube kits below include Tone Control and push-pull output:
 8-Tube Kit, Two Bands, 550-1600 kc and 5.5-18.0 mc.
C24453—**\$41.59**
Your Cost.....

8-Tube Kit, Two Bands, 110-425 kc and 5.5-18.0 mc.
C24454—**\$41.59**
Your Cost.....

5-Tube AC-DC Kit

(E) With Plastic Cabinet. Circuit is the extremely popular five-tube AC-DC superheterodyne using 12SA7, 12SK7, 12SQ7, 50L6 and 35Z5. Includes automatic volume control, true tone reproduction, Streamlined airplane dial, wide tuning that covers 550 to 1600 KC, built in loop antenna and a new Alnico V speaker. Cabinet is a beautiful modern design in brown plastic.

The loop antenna is tuned by one section of the tuning condenser and feeds directly into the mixer oscillator tube, the other section tuning the oscillator coil. No padding is required because of the specially shaped condenser plates. IF channel is 456 KC and uses two double tuned transformers. Kit contains all parts to build complete receiver.

C24456—With cabinet and tubes **\$14.75**
Your Cost.....

Electric Motor Kit and Book for Youngsters

(F) Combination motor kit and large book that every youngster will treasure. The fascinating story of electricity told pictorially in 6 beautifully lithographed brilliant colors. 32 pages of the drama, history, and principles of electricity in easy-to-understand language. Permanent metal binding and hard covers. 33 precision-made parts and wire to assemble an electric motor that really runs. Safe. Operates from flash light batteries.

C24455—Your Cost..... **\$2.95**
C20622—Batteries (2 required). Each..... 6½¢

POPULAR MECHANICS KITS

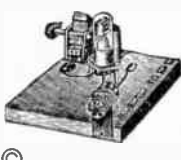
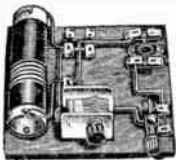
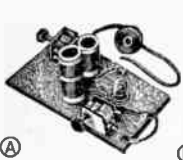
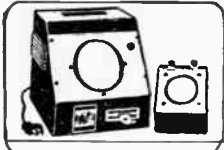

Beginners Crystal Set

(A) Simple design but outstanding performance. Employs a crystal detector of highest sensitivity in conjunction with a coil-condenser circuit. Shpg. wt. 7 lbs. Popular Mechanics R311. Less Baseboard.

C24503—
Your Cost..... \$3.30

Radio Beginners Crystal Detector Kit

(B) Something new in crystal detector sets is this kit designed for radio beginners. No solder required. Fahnestock clips provided to clip wires from one point to the other. Includes all parts as well as an extra-sensitive silicon crystal detector unit. Shpg. wt. 6 lbs.

C24519—
Your Cost..... \$2.45

Beginners "Spec" 1 and 2 Tube Kits

(C) These kits are extremely simple in construction and operation. Both employ a 1Q5GT detector tube. The two tube has another 1Q5GT audio amplifier which boosts the output on standard or short-wave stations. Complete broadcast and short-wave reception. Either set may be operated from batteries or a combination of batteries and B-battery eliminator. Less tubes, earphone, Baseboard and batteries. Shpg. wt. 1-tube kit approx. 3 lbs. 2-tube kit 4 lbs.

C24500—1-Tube Kit,
Popular Mechanics R-305.
Your
Cost..... \$3.30

C24501—2-Tube Kit,
Popular Mec. R-307.
Your Cost..... \$7.59

ELECTRONIC Photo-Print Timer

Accurately controlled timing enables the busy photographer to make uniform prints. This is especially important when making large numbers of duplicate prints, such as personalized holiday cards, etc. The time range is from 1 to 60 seconds and the unit will control any electric appliance or lamp that does not draw more than 250 watts. The relay coil is in series with the plate circuit of the triode-connected portion of a 117L7-GT tube. After a warm-up period, the tube con-

ducts through the relay coil and closes the relay. Principle of operation is grid control of the tube by the mathematically certain time it takes for a capacitor to discharge through a resistor. The dark-room "Safe-lite" is on all the time except during the exposure time period. An enlarged blueprint of all layout and wiring diagrams complete in every detail is furnished with the kit. Popular Mechanics No. R-339. Less tube. Shpg. wt. 6 lb

C24518—
Your Cost..... \$7.67

25 Popular Mechanics Blue Prints

Blue Stock No.	Popular Mech. No.	Name of Kit
C20300*	R305	Beginners "Spec" 1 tube battery kit
C20306	R306	Inter-room Communicator System
C20301*	R307	Beginners "Spec" 2-tube kit
C20302*	R310	Four Watt AC-DC Amplifier
C20303*	R311	Two Modern Crystal Receivers for Beginners
C20304	R313	Safety Code-Practice Oscillator and Short-Wave Receiver for Students
C20305	R317	Emergency "B" Power Unit
C20307*	R323	Portable Phono and Mystery Player
C20308	R327	Dual Phono Unit and Amplifier
C20309	R328	Desk Lamp "DX" "ER" for Boys Room
C20310*	R331	High Quality Ten Watt Amplifier
C20311	R342	1946 "Little Giant" AC-DC Super
C20312	R335	Two Low Cost Receivers for Experimenters
C20313*	R337	Two Tube Pockette Portable
C20314	R338	Three Tube 8 Watt Cake Pan Amplifier
C20315*	R339	Electronic Photo-Print Timer
C20316	R341	Three Tube Short-Wave Superhet
C20321*	R353	1947 Little Giant AC-DC Super
C20317	R354	Beginners Low Cost Progressive Receiver Set No. 1
C20318	R355	Beginners Four-Tube Progressive Receiver Set No. 2
C20319	R357	Dual Purpose Signal Generator for set testing
C20320	R358	Hi-Q 50 8-band Phone and CW Transmitter

*Indicates Kit is described on this page.
Your Cost Each..... 25¢

All **POPULAR MECHANICS KITS** on this page are available for immediate delivery. These are especially well suited for home, classroom and demonstration purposes. Only the highest quality parts are used, thus adapting them to repeated tearing down and rebuilding as is done in training and experimental work.

All kits include large, clearly defined blueprints, complete instruction sheets, all necessary hardware and hook-up wire.

Blueprints may be ordered separately—see list below. Parts list free of charge to those desiring additional information on any kits shown below. Specify project you are interested in.

Portable Phono and "Mystery" Player Kit



May be coupled directly to any radio or may be used as a wireless oscillator type phonograph, thus eliminating the necessity of wiring it to your radio. It is merely necessary to plug into any nearby electric outlet. Oscillator consists of a 6A7 and one type 6C6 rectifier. Shpg. wt. 19 lbs. Popular Mechanics R323.

C24509—Less Tubes and Carrying Case.
Your Cost..... \$14.19

1947 "Little Giant" AC-DC Super

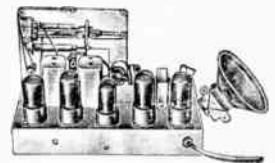

Readers of Popular Mechanics have always found something practical and different in the "Little Giant" receivers described in March issues. This latest model is an excellent performer in the broadcast band, gets police calls, includes AVC, and is easy to build. Uses a standard commercial "Air-Com" permeability tuner and a 5" slide-rule tuning dial. Enlarged blueprint of all layout and wiring diagrams furnished with kit. Uses 12SA7GT, 12SK7GT, 12SQ7, 50L6GT, and 35Z5GT tubes. Popular Mechanics R-353. Less tubes and cabinet. Shpg. wt. 9 lbs.

C24525—
Your Cost..... \$15.51

Four-Watt AC-DC Phono Amplifier

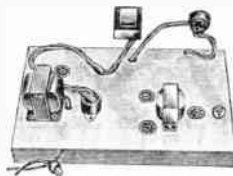

No power transformer required to build this simple music maker. It is an excellent performer and requires very few parts to build. Pleasing tone quality and ample volume with an ordinary record player make it an ideal amplifier for rumpus-room dancing and similar entertainment in the house or recreation center. Output is over four watts, which is more than enough for small groups. AC-DC circuit eliminates the need for a power transformer, keeping the unit light in weight and allowing its use on alternating or direct current. Spring-driven phonograph turntables can be converted for electrical amplification by the use of a crystal or magnetic pickup arm and this amplifier. Tubes used are 6C5GT, two 25L6GT's and a 25Z5GT. Less tubes, speaker, and wooden parts. Shpg. wt. 8 lbs. Popular Mechanics No. R-310.

C24502—
Your Cost..... \$8.10

High Quality Ten-Watt Amplifier

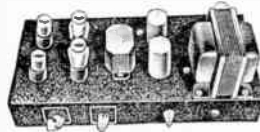

Wherever a good ten watt audio amplifier with negligible distortion is desired this conservatively rated unit "fills the bill." An exceptional bass reproduction method is employed which eliminates the booming unnatural tones so often heard in audio amplifiers. The output stage is resistance coupled with a pair of 6A3 type tubes in push-pull being used. Circuit includes a phase inverter and a simple form of feedback that prevents distortion and reduces hum level to an absolute minimum value. Tubes employed: 6C5, 6N7, two 6A3, 5U4G. Kit complete less 10-inch PM speaker and tubes. Shpg. wt. 24 lbs. Popular Mechanics R331.

C24512—
Your Cost..... \$19.95

Two-Tube "POCKET" Portable

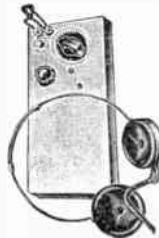

Operates on flashlight cells. Slips into your coat pocket with just enough extending out the top to tune. Built in antenna, self-contained batteries. Very good volume on local stations. Covers the broadcast band with additional range on each side of the dial. Uses two 154 miniature tubes in a standard regenerative-detector circuit transformer coupled to AF output stage. Case is easily made from cigar box. Popular Mechanics No. R-337, less tubes, batteries, headset. Shpg. wt. 5 lbs.

C24516—
Your Cost..... \$5.61

TRANSVISION Television Kits

SAVINGS—When assembled, either of the kits shown below becomes a modern television receiver worth more than twice its cost. The quality of performance has been acclaimed as superior by over 10,000 satisfied customers.

COMPLETE—With sight and sound high fidelity reproduction. Nothing more to buy. No technical knowledge required for assembly. No test equipment needed, instruction sheet gives all the information to complete and put either receiver "on the air."

BEAUTIFUL CABINETS—Exclusively designed for the kits shown below. Made of selected grain wood with attractive hand rubbed walnut finish. An accessory kit is included for use in mounting the assembled kit.

Standard 12" Television Kit

Sensational new 12" television kit. Engineered for easy, rapid assembly. An outstanding television receiver for use in the home, in taverns, and schools, at a saving of hundreds of dollars. Complete with all tubes, parts, wire, and solder, including magnetic deflection type 12" picture tube, and specially designed folded dipole antenna with 60 ft. of lead-in cable. Finest quality parts are used throughout. Complete with easy-to-follow instructions and schematics.

Picture size 75 square inches. (1½ times larger than with a 10" tube.) R.F. Unit, 3 stages of picture IF, and 2 stages of IF coils are all factory wired, pretuned and aligned before shipment for 7 channels. All television channels have band width of 4 mc. for full picture definition. 9000 volt second anode potential for brightness and contrast. High signal sensitivity only 50 microvolts required for picture circuit. 22 tubes and 12-inch picture tube. Measures 24" wide x 17" high x 18" deep.

C24492—Your Cost (Less Cabinet) \$289.00

Deluxe Model with built-in FM Radio. Same as above plus continuous tuning from 50 to 216 mc. Covering entire FM band and all 13 television channels. Cutoff switch to eliminate unused tubes when used as FM receiver only.

C24493—Your Cost (Less Cabinet) \$359.50

Cabinet for 12" kit. In beautiful hand-rubbed wood finish. Fully drilled, ready for installation of receiver.

C24494—Your Cost \$44.95

7" Television Kit

It's easy, quick, anyone can do it. No knowledge of Television or Radio required. Everything is supplied, all tubes (including picture tube), all parts, wire and solder. Complete easy to follow directions, and schematics. All intricate parts are pre-assembled. A boon to those who derive pleasure from creative activity, yet want to keep costs down—for those who want to acquire basic training in television. For experimenters, amateurs, and schools. Opens a new and intriguing field of television to servicemen and repairmen who wish to build and sell this receiver as a complete unit.

Brilliant clear seven-inch picture tube, large six-inch speaker with heavy weight Alnico magnet, provide excellent voice and sound performance. R.F. unit aligned, wired and pretuned to 3 channels before shipment, eliminating need for costly test instruments.

Eighteen-tube set with 3.5 mc. band width picture circuit. Newly designed sweep and synchronizing circuits. 3000 volts second anode voltage. High signal sensitivity, only 100 microvolts required for picture circuit. Measures 17" deep, 17½" wide, 17¾" high. Shpg. wt. with antenna and tubes 59 lbs.

C24497—Your Cost \$169.00

Deluxe model 7" television kit complete with FM radio.

C24495—Your Cost \$199.00

Cabinet for 7" kit. Handsome table model cabinet with all holes and fittings drilled. In smooth hand-rubbed wood finish.

C24496—Your Cost \$32.50

TELEVISION AND Radio Kits

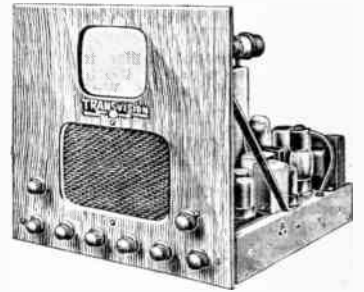

CONCORD Tested Kits for Radio TRAINING

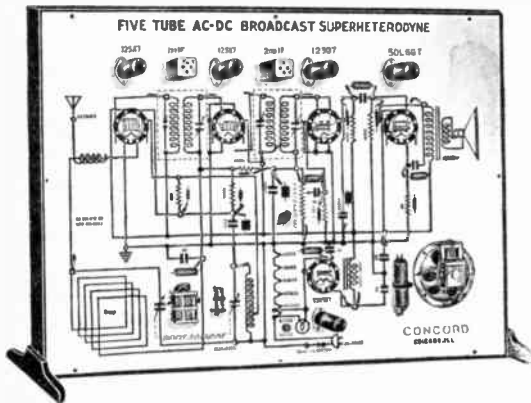

5-TUBE AC-DC DEMONSTRATOR

(A) An excellent demonstration unit designed principally to simplify instruction in the theory of radio circuit design and operation. Circuit analysis and trouble shooting, and proper use of test equipment in repair work. Multiple snap connectors are used on each tube element for signal and voltage measurement; also at circuit junctions so that each coil, condenser or resistor may be opened, or, where it will not damage the unit, shorted out to simulate actual conditions in defective receivers. Circuit diagnosis by use of test equipment can be practised without necessity of wiring in parts which are actually defective.

All trimmers are easily accessible from the front of the panel for demonstration of alignment procedure.

Consists of a 5-tube AC-DC superheterodyne, covering a frequency range of 540 to 1600 KC, with the following tube line-up: 12SA7, 1st detector and oscillator; 12SK7 intermediate frequency amplifier; 12SQ7 2nd detector and 1st audio; 50L6 beam power output; 35Z5 rectifier.

For operation from any 110-120 volt, AC or DC, 50-60 cycle power source. Available in kit form, with every necessary part supplied, and with four-color panel completely finished and drilled. Shpg. wt. 39 lbs.

C24530—CONCORD Demonstrator, in kit form, less tubes. Your Cost \$36.30



One and Two Tube Kits

(B) Ideal for use in elementary radio training, for instruction in detector operation, regeneration, and simple alignment procedure. Both kits use a 6J5GT regenerative detector, and the two tube kit has a 6SK7GT RF stage in addition. Identical chassis and panels are used in both kits, so that the one tube kit may be easily converted to a two-tube with an RF stage with a minimum of additional parts. Frequency range 550 to 1700 KC. Operates from either CRC-20R or CRC-30R power supplies. Chassis and panel completely formed and punched. Panel size, 5½ x 7"; Chassis, 7 x 4½ x 1½". Complete but less tubes, headphones and power supply. Shpg. wt. 7 lbs.

C24523—One tube kit, CRC-10R. Your Cost \$4.84

C24524—Two-tube kit, CRC-10BR. Your Cost \$5.83

Audio Amplifier Kit

(C) A high gain two-stage resistance coupled amplifier, utilizing a 6SJ7 input stage, and 6F6 output stage. Has sufficient gain to operate with high impedance microphones or phonograph pickups. Because of its excellent response characteristics and simplicity it is ideal for use in schools for plotting response curves and in teaching basic audio theory. Fully shielded output transformer with 4-8-16-500 ohm output impedances. Can be used to amplify the CRC-10R one tube or CRC-10BR two tube kits. One CRC-20R supply will insure very good quality. Complete with input and output connections and all other necessary parts. May be used with any good PM speaker. (Not supplied.) Chassis: 5x9½x1½". Shpg. wt. 8 lbs.

C24528—Less tubes. Your Cost \$7.40

Power Supply Kits

(D) Companion units to operate CONCORD kits requiring external power source. Tapped variable voltage divider provides intermediate voltages which, with both filament and high voltages, are terminated at a standard 7-prong socket. Three-section filter uses two heavy duty chokes. In addition to their use as power source for the CONCORD kits described, these units may also be used as a hum-free supply for other receivers, amplifiers, and small transmitters. Complete with all parts except 80 type rectifier tube. Ready to assemble and wire. Chassis size: 5x9½x1½". For 117 volts 50-60 cycles AC.

C24526—350 V., at 70 Ma and 6.3 V., at 3A. Shpg. wt. \$10.89

C24527—350 V., at 140 Ma and 6.3 V., at 3A. Shpg. wt. \$14.30

15 lbs. Your Cost \$14.30

IMMEDIATE SHIPMENT FROM CHICAGO OR ATLANTA

TRINDL ARC WELDERS and POWER EQUIPMENT

- ★ Simple operation
- ★ No Wearing Parts
- ★ Compact and Portable
- ★ Positive Starting Arc
- ★ Magnetic Blow Eliminated
- ★ Flexible Arc Control

Welders for industrial maintenance work, garages, farm machinery repairs, machine shops and all other places where reliable and simple operation is necessary. Can be operated by anyone following directions supplied. Further technical data and information supplied on request.



TRINDL Arc Torch

(A) Works with any 60 to 125 amp. AC or DC arc welder. Anyone can weld, brass, or solder on aluminum, bronze, iron, steel, etc. Complete with 7 1/2 ft. cables, four 1/4x6" carbons, two taper jack plugs, and simplified operating instructions. Shpg. wt. 3 lbs.

C25635—\$6.66
Your Cost.....

Heavy duty model similar to above. For use with any 160 to 360 amp. capacity welder. With 10 ft. cables and 1/4x6" carbons. Shpg. wt. 6 lbs.

C25647—\$24.25
Your Cost.....

Replacement Carbon Electrodes: 12 to the package, per package:

C25648—1/4x6".....\$1.47
C25649—1/4x6".....1.76

TRINDL Electrode Holder

Unique design allows rod to be held in several positions. Strong, high conductivity bronze jaws make this holder extremely durable. Shpg. wt. 2 lbs.

C25640—150 Amps. \$4.16
Each.....

C25641—300 Amps. Each. \$4.90

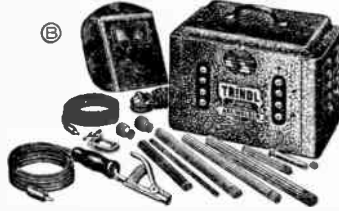

Model 75A

(B) Portable. Operate from any properly wired 110 volt line. Welds iron, steel, brass and other metals, from 20 gauge to 1/8" thick on a single pass, much thicker work by repeating passes. Handles 1/8 to 3/16" welding rods. 9 heat stages from 20 to 60 amps. Complete, ready to operate, with headshield, electrode holder, 2 welding cables, clamp, welding rods and detailed instructions. 10x13x10". Shpg. wt. 40 lbs.

C25625—For 110 Volts, 60 cycles. \$38.71
Your Cost.....
C25626—For 220 Volts, 60 cycles.....\$41.65
C25627—For 110/220 Volts, 60 cycles.....47.53

Model 125A

(B) Similar to Model 75-A above but larger and for heavier duty. Welds metals up to 3/16" thick on single pass, handles 1/6 to 3/8" welding rod. Vernier-type arc control, 16 heat stages from 10 to 125 amps maximum, 110 amps continuous. Input line frequency 50 to 60 cycles. 10 1/2 x 15 3/8 x 10 1/8". Shpg. wt. 100 lbs. Comes complete with all accessories.

C25630—For 110 Volts. \$68.11
C25631—For 220 Volts. \$68.11
Either Model Above. Your Cost.....
C25632—For 110/220 Volts.....\$77.91

Model 160A

(C) Heavy duty floor model. Ideal for high-grade, high-speed production and maintenance jobs in sheet metal shops, mills and factories, and farm-equipment repair. Welds metals up to 3/8" thick on single pass, handles 1/4 to 3/16" welding rod. Vernier-type panel control, 36 heat stages from 20 to 160 amps continuous. Beautiful red crackle-finish welded steel cabinet, modern sloping control panel, and easy-rolling casters. Comes complete with all accessories. 29x19x14 1/2". Shpg. wt. 170 lbs. For 220 Volts, 50/60 cycles.

C25628—Your Cost \$146.51
C25629—For 110/220 Volts, 50/60 cycles.....\$156.31



AUDEL'S Welders' Guide

422 pages of fundamental welding operations, as well as specialized techniques of hand and machine welding. Handy reference index gives you immediate solution to all welding problems. Size: 5x6 3/8".
C20296 Postpaid. 98¢
Your Cost.....

Welding Gauntlet



Preferred by welders because of their low cost, light weight, softness and flexibility. Highest quality specially tanned horsehide suede with four-inch gauntlet. Thumb and forefingers are reinforced to give durability and added life.

C25642—Your Cost, Per Pair \$2.20

TRINDL SPEEDWELD Mild Steel Welding Rods

A high grade, deep penetrating, mild steel general purpose shielded arc welding electrode. For use with AC transformer-type machines

Stock No.	Size	Min. Amps.	Max. Amps.	Your Cost
C25650	1/8x9"	20	40	\$2.84
C25651	3/16x9"	20	60	2.19
C25636	3/16x12"	30	80	1.22

or on straight polarity with DC welders. Light tan flux coating. Furnished in 5-lb. packages, at package costs as below.

Stock No.	Size	Min. Amps.	Max. Amps.	Your Cost
C25637	1/8x14"	70	120	\$0.86
C25638	3/16x14"	120	200	.76
C25639	3/16x14"	150	280	.73

KATO Gas-Electric Plants

Filtered, shielded, compact and lightweight as the best engineering can provide consistent with rugged durability and power output. Both models illustrated provide 115 volts 60 cycles AC at the rated wattages for continuous duty, and the first model shown also provides 150 watts at 6 volts DC for charging batteries. Both use air-cooled gasoline engines for simple operation with minimum maintenance.

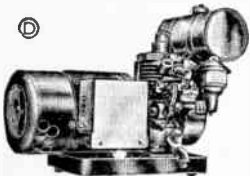

(D) Portable units. 500 watt unit has 1 h.p. single-cylinder engine. 600 watt unit has 1.4 h.p. single-cylinder engine. Will run 6 to 6 1/2 hours on 1 gallon of gasoline. Both units have start and stop push buttons, with cutout, DC ammeter, charging control resistor, and battery cables. One 6-volt storage battery required for starting (not supplied).
C19819—Model No. 231AAB4, 500 watts, weighs 170 lbs. \$136.50
Your Cost.....

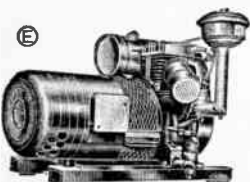

C19820—Model No. 14HAB4, 600 watts, weighs 220 lbs. \$181.10
Your Cost.....
(E) Heavy duty unit. 1000 watts continuous duty output. Single-cylinder, 4-cycle, 2.4 h.p. engine. Runs 4 1/2 hours on 1 gallon of gasoline. Manual starting. Weighs 265 lbs. Shpg. wt. 295 lbs.
C19821—Model 26HAB4. \$257.25
Your Cost.....

CARTER Genemotors and Super-Converters

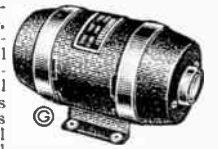

(F) Genemotor, standard for police radio, amplifiers, small aircraft transmitters, small vessels. Low ripple, efficient, dependable. All ratings for continuous duty except numbers marked (*) are Int. All less filter and relay. All inputs are 6 volts DC except **C17208** which is 5.5 volts DC.

Stock No.	Input Amps.	Output Volts	Input MA	Cost	Stock No.	Input Amps.	Output Volts	Input MA	Your Cost
C17200	7.9	250	100	\$32.24	C17201	10.9	350	100	\$33.61
C17202	14	350	150	35.67	C17203	18.2	400	150	37.04
C17208	25	400	200	\$41.16	C17206*	27.4	500	200	40.47
C17204	23.4	400	200	39.44	C17209*	32	600	200	44.25
C17205*	27.4	400	250	37.73	C17213*	39	600	250	46.51

(G) Super Converter, change 115 Volt DC to 115 Volt, 60 cy. AC. for non-inductive loads. Minimum load P.F. 85%. All models here are for continuous duty. 13 lb. frame is 8 1/4 x 4 1/2 x 4 1/4". 19 lb. frame is 10 1/4 x 4 1/2 x 4 1/4".

C17214—13 lb., 100 watts. \$41.16 **C17216—19 lb., 200 watts. \$50.76**
C17215—13 lb., 150 watts. 44.59 **C17218—19 lb., 250 watts. 54.19**



DETECT-O-RAY Electric Eye

Use for Remote Controls, Automatic Counters, Sorters, Electric Door Openers, Burglar, Fire, Smoke Alarms, Machine Safety Devices

(A) Projects a light beam which is reflected by a small external mirror to the photo cell in the unit. Any object breaking either beam instantly activates an alarm, bell, camera, safety device, or sets into action any other unit you wish to perform work automatically. Provides perfect burglar and fire protection for homes, stores, offices, or factories. Many industrial applications such as safety devices on machines, as sorters, conveyor controls, electric door openers or automatic counters.

Effective range is about 60 ft. on the White beam; about 35 feet on the "Unseen" beam. Selection of beams by switch on front panel. Sensitivity dial regulates units reaction to purpose and conditions. Signal selector for choice between Continuous Action from one break in beam until shut off—or Single Action with each break.

Simple to install. Plugs into 110 V AC light socket. Housed in attractive black wrinkle finished steel case. 5" high, 6 1/4" wide, 7" deep. Shpg. wt. 7 lbs.

C15725—Complete with outside mirror.
Your Cost

\$27.78

Photo Electric EQUIPMENT

DETECT-O-RAY Power Relay

(B) Model L-205 Power Relay carries 1000 watts, at 110V AC. Require no extra wiring to be used for controlling most motors, machinery, floodlights and other devices. Input plugs into 110 V AC socket. Output connects to device you wish to control.

C15724—Your Cost **\$6.86**

Cetron Phototubes

(C) The finest phototubes for use in Worner equipment listed on this page.

Type CE-23-C—Gas

160 microamps average sensitivity per lumen.

C10580—Your Cost **\$2.84**

Type CE-1-D—Gas

100 microamps average sensitivity per lumen.

C10581—Your Cost **\$2.55**

Selenium Photo-Cell

(D) These cells are of the barrier layer, self-generating type. Light striking upon cell generates current sufficient to operate relays directly without the use of auxiliary power. The lifetime of the cell is unlimited for practical purpose. Leliuers 600 microamperes output at 100 foot candles, 2" diameter, mounted in plastic housing.

C10576—Photo Cell, in plastic housing.
Your Cost **\$9.37**

WORNER Fotoelectric Announcer

(A) Designed to project a light beam across entrance. Breaking of the light beam by any person entering will activate a chime or other device to announce the entrant. Model 61 includes light source, and sensitive photo cell unit in compact metal case. Supplied with mirror for reflecting light up to 10 feet. For 115-volt, 60-cycle, A.C.

Less chimes.
C15654—Your Cost **\$16.35**

Model 301 Mirror

Can be used in connection with any model alarm. Function is to reflect the beam around obstructions, and to criss-cross the area to be protected, making it impossible to avoid beam. Size 8x4x2 1/2".

C15657—Your Cost **\$4.22**

WORNER Burglar Alarm System

(B) Light source projects beam of invisible infra-red light to condensing lens of receiver. Interruption of beam or disconnection of power to the unit operates a relay which may be connected to any audible or visible alarm device. Alarm is continuous and can only be silenced by the possessor of key to pick-proof switch lock on the receiver. Mirrors may be used to project the light beam around a room to protect several entrances simultaneously. Can be operated with light beam lengths of up to 100 feet. For 110 volts 60 cycle AC only. Shipping weight 10 lbs.

C15659—Model 5100 System. Your Cost **\$55.12**

WORNER Industrial Photo-electric Set

(C) A two-unit system for use in counting, grading, sorting and speed control in conveyor belt set-ups, to operate automatic doors, and as safety device on heavy machinery. Relay in receiver unit operates up to 500 times per minute. Receiver includes light cell, amplifier sensitivity control and relay. Sensitivity may be set so that unit is not affected by daylight or artificial light. Light source contains low-wattage bulb with approximately 2000 hours' life. Throws concentrated beam up to 50 feet. Less counter.

C15655—Your Cost **\$51.45**

Photo Electric Eye Amplifier Kit

(D) Burglar alarm, door announcing, counting and sorting are just a few of the many applications of the photo electric eye amplifier. Operates with any light source. Kit contains all necessary parts and complete instructions, including 5 1/2 x 4 1/2 x 2 1/2" case. Operates on 115 volts, AC or DC.

C15672—Your Cost **\$9.75**

Photo Electric Light Source Kit

(E) Dependable light source for above amplifier kit. Projects a beam of light 25 feet. Kit includes light bulb, socket and all necessary parts including case. Operates on 115 volts, AC or DC.

C15673—Your Cost **\$5.83**

TORK Freezalarm

(F) Gives warning of electrical or mechanical failure of deep freeze refrigerators. Provides a single-stroke alarm bell every few seconds for 18 to 20 hours. Alarm uses spring-driven mechanism, that is always fully wound but electrically locked. Upon rise in temperature or power failure, alarm goes off. For 110-volt AC.

C15605—Your Cost **\$24.50**

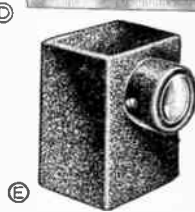

TORK Electric Time Switches

(C) Self-starting, for automatic control of solenoid valves, signs, stokers. Shown with cover off. For 110 volts 60 cycles, 8 1/2 x 5 x 3 3/4". Shipping weight 8 lbs. Model 191B has 2 1/2-minute ratchet dial. Capacity 20 amps., 2000 watts. For general use. Single-pole on-off switch.

C15600—Your Cost **\$9.10**

Model 962B

Double pole. Capacity 4000 watts, 20 amp. per pole.

C15601—Your Cost **\$10.50**

Model 5191BP Poultry House Lighting Timer

For morning and evening operation. Bright light circuit 2000 watts. Dimmer circuit 800 watts.

C15602—Your Cost **\$12.95**

Personal Model similar to Model 191B but in portable case, fitted cord and plug and a clock controlled receptacle. Automatic control at 15-min. intervals of fans, heaters, bedside radios. Minimum setting of 45 minutes between on and off positions. Capacity 600 watts.

C15603—Your Cost **\$8.40**

C15604—Same as above but 1320 watt capacity. **\$9.45**

Your Cost

Service Needs



Bakelite Knobs
Molded and polished walnut bakelite knobs for 1/4" shafts. All are set screw type except those marked with * which are brown push-button knobs; † is knurled hole mtg.; ** have recessed tops.

Stock No.	Type	Dia.	Each	10 For
C9655	A	1 3/8"	8c	72c
C9693	B†	1 1/2"	4c	33c
C9736	D	1 1/2"	5c	44c
C9737	D	1 1/2"	6c	54c
C9692	E	1 1/2"	3c	44c
C9694	G*	1 1/2"	5c	27c
C9695	G**	1 1/2"	5c	27c
C9661	H*	1 1/2"	4c	33c
C9696	I**	1 1/2"	7c	63c
C9657	J	1 1/2"	7c	63c
C9660	L	1 1/2"	7c	63c

Midget Knobs
With and without the pointer illustrated. For small sets. 1 1/16" dia. Set screw. 1/4" shaft.

Color	Pointer	Pointer	Each	For 10
Walnut	C9676	C9680	6c	54c
Ivory	C9677	C9681	6c	54c
Red	C9678	C9682	6c	54c
Black	C9679	C9683	6c	54c

Kit of 50 Knobs
Assorted sizes and colors in new, modern designs as used on the latest post-war sets. All standard shaft size openings. Four each of 12 different designs, two each of one design. Kit consists of 12 set screw type, 18 knurled shaft type and 20 flattened shaft spring type.

C9662—Your Cost. \$2.48

Pointer and Lever Knobs
Polished black bakelite. All have filled pointers except "M" (has ridged top). For 1/4" shafts.

No.	Len.	Ht.	Type	Each	10 For
C13027	2 1/2"	1 1/2"	(C)	9c	72c
C13028	1 1/2"	1 1/2"	(C)	6c	54c
C13053	1 1/2"	1 1/2"	(F)	5c	44c
C13024	1 1/2"	1 1/2"	(F*)	7c	63c
C9650	1 1/2"	1 1/2"	(M)	8c	72c
C9651	2 1/2"	1 1/2"	(M)	10c	90c

*Red Bakelite.

G.C. Knob Puller
Knobs that are hard to grip can be easily removed with this knob puller. Simply slip the G-C puller behind the knob and pull it off. Saves time, the cabinet, and the knob. Have one in your shop and in your tool kit!

C15042—Your Cost. \$1.54



WALSCO Flock Spray Outfit
Complete. With instructions. Beginners turn out professional velvet-like flock jobs. Contains spray gun, ivory and brown felt flock, undercoats to match, thinner, brush. Shpg. wt. 3 lbs.

Walsco K-50, Complete outfit. **C15489—\$6.76**

Spray gun only from the outfit. **C15490—\$2.32**

455. Walsco

Extra containers of felt flock, 3 1/2 oz. each (1 oz. covers 1 1/2 to 2 square ft.), in bright colors:

- C15491—#470, Brown
- C15492—#471, Ivory
- C15493—#474, Red
- C15494—#475, Green

Extra half-pint cans of undercoat; acts as color base and adhesive. 1/2 pint covers about 10 square ft. on non-porous surfaces.

- C15495—#480, Brown
- C15496—#481, Ivory
- C15497—#484, Red
- C15498—#485, Green

Extra half-pint can of thinner. Use to clean brush and thin out undercoat if necessary. **C15499—Walsco #468—\$3.24**



AMPHENOL "Liquid-912"
Polystyrene base. A synthetic resin that is non-hygroscopic and has low-loss factor. Ideal for high frequency coils. Prevents humidity variations from altering your calibrations or log positions. Keeps metallic dust particles from coils. Use on antenna connections.

C15362—2-oz. bottle. \$2.94

C15363—1-oz. bottle. 38c

"916-2" Thinner for "912" with brush. **C15364—2-oz. bottle. \$1.54**

Radio Service Cement
Suitable for cementing replacement cones and repairing torn cones. Used on glass, to hold wires in place, etc. Vibration-Proof, Waterproof, Fast-Drying.

C15314—2-oz. bottle, brush attached to cap. Each 29c

C15315—4-oz. bottle. 53c

C15316—8-oz. bottle. 94c

C15317—1-pt. bottle. \$1.76

All-Purpose Cement
For speaker cones, bakelite, metal, wood, hard-rubber, etc.

C15310—2-oz. size. 32c

C15311—8-oz. size. 94c

C15312—1-pt. size. \$1.76



WALSCO Plastic Cement
Cements plastics, metal, wood, glass, etc. Dries fast. Strong bond. Waterproof and heat resisting. Especially made to repair broken plastic cabinet knobs, grid caps, etc. Brush attached to cap. Walsco No. 42, 2-oz. bottle.

C15321—Your Cost. \$3.24

KROMALL
KROMALL gives that smooth satiny appearance and provides a finish that can hardly be distinguished from metal. Shows no brush marks or laps, flows to a beautiful chrome-like finish. 20-min. set, 4-hr. drying.

C15305—4-oz. bottle. 23c

C15306—16-oz. bottle. 60c

"WALSCOLUB B" Lubricant
New chemical that eliminates noise on bandswitches, controls, and other air-exposed contacts. Superior to graphite. In a dispenser tube.

C15378—Your Cost. \$2.94

DUCO Cement
Excellent for repairing speaker cones, cementing grille cloths, etc.

Lots of 12. 19c ea.

C15257—Each 21c

WALSCO Contact Cleaning Fluid
Prepared to clean tuning condenser springs, volume controls, band switches, etc. Prevents future corrosion of contacts. With brush. 2-oz. bottle.

C15377—Each 24c

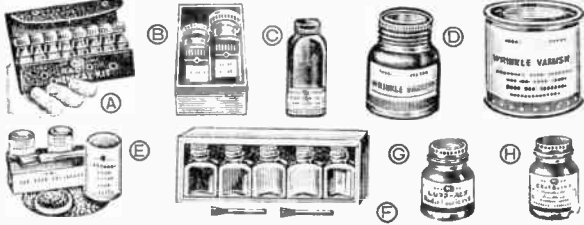

GENERAL CEMENT SERVICING NEEDS

Radio Chemical Kit
A complete kit of 8 chemical necessities in a neat leatherette pocket case. A handy kit for servicemen. Consists of the following necessities: Service Cement, Rubber Drive Cement, Carbon-X, Grafoline, Scratch Polish, Non-Slip Compound, Dial Gil, and Contact Cleaner. An applicator is attached to the cap of each container to make it easy to use.

C15529—Your Cost. \$1.62

Felt-Koat "Flock Finish Kit"
Complete Flock Finish Kit for applying soft felt-like flock to phono turntables, cabinets, testers, panels, displays, tool chests, compartments, lamp bases, wire mesh on speakers, and microphone grills, etc. Produces heavy soft velvet-like coat that prevents scratching. Easy to apply. DeLux Kit containing Brown flock, special applicator, undercoat, thinner and brush.

C15528—Your Cost \$1.18

Coil Dope Kit
Has a polystyrene base and its power factor loss is negligible even if used for high frequency work. Will render articles moisture proof. May also be used for cementing parts made of polystyrene. Kit contains 2-oz. bottle of coil dope, 1-oz. bottle of thinner and two brushes. Shpg. wt. 1 lb.

C15313—Your Cost. \$3.54

Color Coding Enamel
For color coding coils, terminals, etc. Green, blue, red, yellow and a bottle of thinner. Two brushes are included. Have your own system of color coding. Adds greatly to appearance.

C15258—Your Cost. 44c

Air Drying Finishes
Now you can get professional appearing finishes in either crystal, wrinkle or smooth with these new air-drying finishes. Simply apply and let it dry for durable and lasting finish. Air-dry or bake on metal or wood. In 2-oz. and 8-oz. sizes.

CARBON-X—For Noisy Carbon Controls
A practical method to touch up worn and noisy spots on carbon controls. Just apply Carbon-X over the bad spots. Ideal for servicemen. Also an electrical conductor.

C15531—1-oz. bottle. 29c

C15532—2-oz. bottle. 44c

Wrinkle Lacquer (Crystal)
2 oz. 8 oz.

No.	Each Color	No.	Each
C15259	26c Black	C15309	88c
C15319	26c Gray	C15387	88c
C15320	26c Brown	C15388	88c
C15380	26c Red	C15389	88c

Wrinkle (Varnish) Finish

No.	Each Color	No.	Each
C15381	26c Black	C15390	73c
C15382	26c Red	C15391	73c
C15383	26c Gray	C15392	73c

Telephone (Smooth) Finish

No.	Each Color	No.	Each
C15384	21c Black	C15393	62c
C15385	21c Gray	C15394	62c

Thinner for Above Finishes

C15396 21c Thinner C15397 44c

LUBE-REX
A contact cleaner that is ideal for attenuators, push button switches, etc. Cleans contact and prevents corrosion. Moisture repellent, rust preventing and clings to metal. Excellent for Philco Mystery controls.

C15533—2-oz. 29c

C15534—1-pint. \$1.32

GRAFOLINE
Made for noisy controls, switches and wire wound controls. Eliminates noises.

C15535—2 oz. 21c

C15536—Pint. \$1.18

MUELLER Clips and Plastic Insulators



Spring actuated clips for lab., test and battery uses. Type 27 and 27C are laboratory types with mesh teeth on three sides, others have teeth in front only. New Plastic insulators cover entire clip as shown. Listing below shows insulators opposite proper size clip. All packed 10 to a box; clips are marked + and - (5 each), insulators 5 red and 5 black.

CLIPS				INSULATORS				
No.	Type	Size	Each	10 For	No.	Type	Each	10 For
C16029*	45	1 1/2"	5c	\$0.36	C16031	47	9c	\$0.59
C16030†	45C	1 1/2"	6c	.54	C16031	47	9c	.59
C16032*	48I3	2"	5c	.39	C16033	49	9c	.59
C16034*	24A	3"	10c	.78	C16035	26	19c	1.27
C16026*	27	2 1/2"	8c	.68	C16028	29	12c	.82
C16027†	27C	2 1/2"	13c	1.17	C16028	29	12c	.82
C16018†	21A	4"	13c	1.17	C16019	23	32c	2.25

*Cadmium plated steel. †Lead coated steel. ‡Solid copper.

No. 85T Mueller Crocodile Tip Clip

For connecting Bridges, Voltmeters, etc., or anything having binding posts with non-removable heads. Fine for test prods.

C16023—Your Cost Each	11c	10 For	93c
No. 85. As above, less phone tip.	5c	10 For	44c
C16020—Your Cost Each	6c	10 For	36c

Plastic insulator for either of the above No. 87

C16021—Your Cost Each	16c	10 For	\$1.31
-----------------------	-----	--------	--------

MUELLER Wee-Pee-Wee Clip

Non-Ferrous R.F. Clip. Will not heat in high frequency circuits. Ideal for tapping coils. Length 1 1/2". Completely insulated with Red or Black jacket (specify color desired. No. 88-93).

C16022	16c	10 For	\$1.31
--------	-----	--------	--------

FAHNESTOCK Clips



Fahnestock clips used where connections must be made and broken a great deal. No tools required to make connection. Grips wire with right pressure for good electrical contact without injury to wire. All are nickel-plated brass except* which are nickel-plated bronze. All are 3/8" wide except* which are 1/16".

Stock	Fig.	Lgth.	Max. Wire	Mtg. Hole	10 For	1000 For
C14824	B	1"	No. 10	No. 8	8c	\$ 6.40
C14828	C	1 1/2"	No. 10	No. 8	14c	9.40
C14826	A	1 1/2"	No. 10	No. 8	36c	29.00
C14823*	B	1 1/2"	No. 14	No. 6	7c	5.60
C14825*	A	1 1/2"	No. 14	No. 6	30c	24.80
C14820†	D	1 1/2"	No. 10	Copper lug	44c	34.20
C14821	E	3/4"	No. 12	No. 6-32	13c	8.50

Screen Grid Clips

Miniature Clips for Metal Tubes. With wire ferrule.

C14985—Your Cost Ea.	2c
Per Doz.	10c
For Glass Tubes	
C14827—Each	2c
12 For	10c
100 For	75c

Rubber Insulated Clip

Soft rubber outer covering. Each with approx. 12" lead.

No.	Type	Each
C11620	—For 806, etc.	16c
C11621	—Glass tubes	10c
C11622	—Metal tubes	10c

Angle Brackets With Tapped Holes

Stock	No.	Size	Each	10 For
C14909		3/2 x 1/2"	3c	27c
C14910		3/2 x 3/4"	3c	27c
C14911		3/2 x 3/8"	4c	36c

BELDEN Terminal Assortment

Contains 100 most popular solder terminals. For all servicing and set building requirements. In transparent container.

C14790—Your Cost	42c
------------------	-----

Battery Clips

Good quality spring clip. Heavily plated steel body.

C16060—1 1/2" long.	3c	25c
C16061—2" long.	5c	42c
C16062—2 1/2" long.	6c	54c

Threaded Rods

Brass threaded rod for making your own long screws. Easily cut to any length. In 12" lengths.

C14913—6-32 size. Per Lgth.	18c
C14914—8-32 size. Per Lgth.	18c
C14918—10-32 size. Per Lgth.	24c

Rivet-Eyelet Punch Set

Hardened steel tools. Cast iron holder. Hex sides to grip in vise. With rivets and eyelets.

C15045—Your Cost	\$2.35
Rivet—Eyelet Assortment	47c
C15066—100 assorted rivets and eyelets.	47c

CLIPS HARDWARE TUBE SHIELDS

Jacket Type Tube Shields

Will form-fit all glass tubes. Bodies consist of two halves snugly held to the tube by a spring ring. Supplied complete with ground clip to be held by socket mounting bolt against shield.

C13258—For ST-14 tubes with or without cap such as 24A, 01A, 26, etc.

C13262—For ST-12 tubes without caps such as 27, 50, 41, 1H4G.

C13264—For ST-12 tubes with grid cap such as 6C6, 57, 58, 75, 6A7, 6J7G, etc.

Any Type Above, Each 7c

10 For .59c 100 For \$5.75

"Form-Fit" Shields

Smooth, seamless drawn walls assure a snug, positive fit on the tube. Vertical grooves provide flexible fit, and the shield automatically grounds to the tube base on metal based tubes.

For GT Tubes: 1.218" base.

C13256—Open top.

C13257—Closed top.

For GT/G tubes: 1.165" base.

C13246—Open top.

C13247—Closed top.

For Loktal Tubes: C13247—Closed top.

Each, Any Type Above... 3c

10 For... 24c

Bantam Tube Shields

Designed especially for the new 1.5 volt and bantam "GT" tubes or other "T-9" bulbs. Available with and without grid cap, as described below.

C13259—Thin shield, without cap. One-piece, grounds automatically 10 For... 24c

Your Cost Each... 3c

C13260—Same as above, but with short cap and ground clip. For tubes without top grid cap. Type A. 10 For... 38c

Your Cost Each... 4 1/2c

C13261—Type B. With grid-lead cap and ground clip. 10 For... 49c

Your Cost Each... 5 1/2c

Metal Tube Cap Shields

For use with screen grid metal tubes. Bakelite insert prevents shorting.

C13216—Your Cost Ea. 15c

10 For... \$1.35

Regular type without insert. C13217—Your Cost, Each... 6c

Split Lock Washers

C14791—For No. 6 screws

C14792—For No. 8 screws

C14793—For No. 10 screws

Your Cost For 25 7c

Bumper Feet

Of felt, with No. 6 P-K screw for mounting. Felt is permanently clamped in place by metal ring 1/4" in diam.

C14757—Your Cost Each... 3c

10 For... 25c

100 For... \$1.96

Hole Plugs

10 ass't. sizes snap button hole plugs in cellophane envelope. Handy for plugging up holes in panels, chassis, etc. up to 1/16" thick.

C14837—Your Cost Per 10 Ass't. 24c

Steel Screws & Washers

10 3/2 oval head screws. The cup washer, also 10 3/2 is designed to match the screw head in appearance.

Stock No. Length 12 For

C14775 1/2" 6c

C14776 1" 8c

C14777—Cup washer

Your Cost for 12... 7c

Snap Fastener Battery Terminals

Same as used for Ever-ready types 430, 435, 455, 467; Burgess type XX-45 nidget batteries.

C11732—Set of 2 (1 male, 1 female). 10 sets for 25c

Your Cost... 3c

JOHNSON Tube Clamp

Holds tube securely to withstand heavy vibrations and shock. For 1 1/2" diam. tube.

C13157—Each... 21c

Metal & Glass Tube Cap

Fits either type. With 11" lead and pin-tip. In red or black. Specify color with order.

C11728—Your Cost Ea. 15c

Cable Clamps

Heavy gauge steel. No. 6 mtg. hole. Plated.

C14951—1/4" cable. 4 For... 3c

C14952—1/2" cable. 3 For... 5c

Mounting Lugs

Of heavy plated steel. Hole in flat end for 1/2 screw; threaded end 5/8.

C14955—Per 10... 8c

Your Cost Per 100... 45c

Wing Nuts

Sturdy, well made. Have numerous uses.

Stock No. Thread Per 10

C12926 6-32 31c

C12927 8-32

C12928 10-32

C12929 1/4-20

Per 100 (assorted)... \$2.90

BINDING POSTS PHONE TIPS BANANA PLUGS

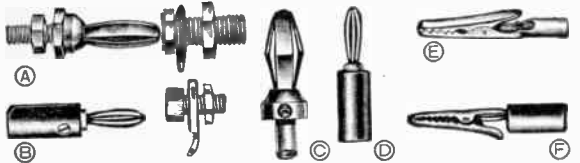

Plain Banana Jacks and Plugs

(A) Plug is 1 1/4" long. Jack is 3/8" long and fits 1/8" hole in panels up to 3/8" thick.
C12919—Plug, Each 7¢
 10 For 60¢ 100 For \$5.40
C12923—Jack, 4¢
 Each 35¢ 100 For \$3.25

Insulated Banana Jacks and Plugs

(B) Plug has set screw for solderless wire connection. Jack fits 1/4" hole and panels up to 3/8" thick. Red or black insulation on both. Specify color desired.
C12915—Plug 10 For 100 For
Each 12¢ \$1.08 \$9.70
C12916—Jack 10 For 100 For
Each 9¢ 81¢ \$7.60

Beryllium Banana Plugs

(C) Signal Corps approved. Used on all government equipment. Made of Beryllium copper. Rivet shank of plug can be turned over without splitting. Shank 1/4" long. 1/8" diam. Overall size 1 1/4".
C13183—Your Cost Each 9¢
C13184—Overall size 1 1/4". Same but with 6-32 threaded stud 3/8" long.
Your Cost Each 15¢



Right Angle Tip Plugs
 Streamlined plugs with set screw for solderless connections.
C12937—(A) Specify red or black.
Your Cost Each 24¢
C12984—(B) Red. } 26¢
C12985—(B) Black. }

Solderless Insulated Phone Tip Plugs

(C) Solderless type: fit all standard tip jacks. Used on test leads. In red or black; specify color.
C12973—2" long. } Each
C12974—1 1/2" long. } 10¢
 Per Ten, Either Type 90¢

Standard Phone Tips

(D) Well made. Heavily plated. Takes up to No. 18 wire. 1" long.
C14881—10 For 12¢
 Per 100 \$1.02

Plain Solderless Phone Tip Plugs

(E) All metal tip plug for tip jack use. Solderless connection. 1 1/2" long.
C12943—10 for 54¢ 6¢
Your Cost Each 6¢
 As above but 1 1/4" long.
C12944—10 for 54¢ 6¢
Your Cost Each 6¢

Split Type Banana Plug

(D) Insulated. Fit standard banana jacks. Set screw in barrel for solderless connection. Positive spring action. Plug 1 1/2" long; overall 1 7/16". Red or black; specify.
C12902—
Each 12¢
 10 For \$1.07

Alligator Clips

(E) Powerful grip. 2" clip is 1/4" wide, 2 3/4" clip is 3/16" wide. Steel non-rusting finish.
 No. Length Each 10 For
C12955* 2" 5¢ 39¢
C12956 2 3/4" 12¢ \$1.08
 *End takes banana plug.

Copper—with bronze spring. For RP work. Has set screw 2" long.
C12947—
Your Cost 7¢
 10 For 50¢

Insulated Alligator Clips

(F) Plated metal grips with insulated handles that take banana plugs. Handles in red or black; specify. Steel non-rusting finish.
 No. Length Each 10 For
C12911 2 1/4" 7¢ 63¢
C12909 3 1/2" 15¢ \$1.35
C12949* 2 1/4" 10¢ 88¢
 *Copper—with bronze spring.

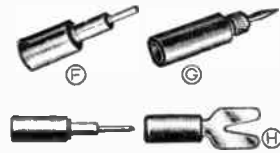

Heavy Duty Phone Tip
 (F) High quality heavy brass. Nickel plated. Used on test leads—prods, etc. 1 1/2" long overall.
C14822—
Your Cost Each 8¢
 10 for 72¢

Phono Needle Plug

(G) Constructed so that the insulated sleeve will take a banana plug, and the prod itself will make positive contact with the banana plug. Tip holds phono needle (needles easily replaceable). Overall length 1 1/4". Red or black; specify color.
C12917—
Each 12¢
 10 For \$1.08

Phone Tip and Lug Adapters for Prods

(H) Handy for use with any banana plug, or test prod fitted with a banana plug end. Fits either tip jacks or binding posts. Red or Black—Specify color.
C12913—Phone tip end.
C12914—Spade lug end.
Each, Either Type 10¢
 10 For 90¢



EBY Binding Posts Non-Removable Tops

(A) Specially designed for use on metal chassis. Post has hole for wire or phone tip.
C13082—Junior Post. Has 6-32 stud, 1 1/2" long.
Your Cost Each 15¢
C13083—Ensign Post. Has 6-32 stud, 3/4" long.
Your Cost Each 23¢
C13084—Commander Post. Has 8-32 stud, 3/8" long.
Your Cost Each 29¢

EBY Twin Post Units

Two posts molded into a Bakelite base.
C13062—Your Cost 42¢
 As above, but with three posts.
C13063—Your Cost 73¢

Insulated Posts

(B) Red or black composition top. Plated ferrule. Specify color. 10 for 99¢.
C13163—
Your Cost Each 11¢

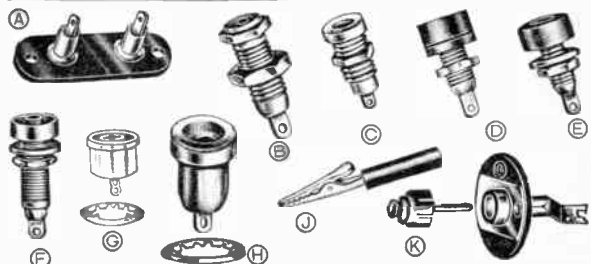

Tip Jacks

(A) Mounted on 3/8" Bakelite. Contact springs grip cord tips securely.
C13037—Double jack. Ea. 9¢
 10 For 81¢
C13036—Triple jack. 14¢
Your Cost Each \$1.26
 10 For \$12.60

Plain Tip Jacks

(B) For test equipment. Powerful spring. 1/4" mounting hole.
C12918
Your Cost Each 6¢
 10 For 54¢

All Insulated Tip Jack

(C) Countersunk 1/2" d. head. 3/8" overall. Fits 3/8" hole. Bronze spring.
C12934—Red 9¢
C12935—Black } 9¢
 10 For 80¢

Insulated Tip Jacks

(D) Have new type springs which provide sure grip contact. Mounts in 3/16" hole. In red or black. Specify color.
C12879—Each 9¢
 10 For 80¢

Molded Bakelite Insulated Tip Jacks

(E) Large diameter molded Bakelite heads take all phone tips. Phosphor bronze springs. With insulating washer.
C12877—Red } Each
C12878—Black } 12¢ 10 For
C12878—Black } 12¢ \$1.08

Combination Jack

(F) New type, takes both phone tips and banana plugs. Fully insulated, with insulating washer. In red or black. Specify color desired.
C12925—
Your Cost Each 11¢
 10 For 99¢

Spring Clamp Binding Posts

(C) Insulated top. Spring clamp holds wire. Overall length 1 1/2".
C13046
Your Cost Each 7¢
 10 For 63¢

Binding Post With Banana Jack Top

(D) Hole in top takes banana plug. Hole in stem for wire. In red or black. Specify color when ordering.
C12945
Your Cost Each 15¢
 10 for \$1.35

Spring Clamp Binding Post Assembly

(E) Mounted on Bakelite strip 2" long, 1 1/8" wide. Centers 1 1/8". Marked "Ant" and "Gnd."
 10 for \$1.44
C13049—
Your Cost Each 16¢

UHF Tip Jack

(G) Takes standard phone tips, but contact may be removed and the body used as an UHF thru-panel bushing as well. Mounts in 3/4" dia. hole. Retainer ring included.
C12767—
Your Cost Each 18¢

AMPHENOL Phone Tip Jacks

(H) Bakelite body. Takes standard plain or solderless phone tips. Mounts securely by means of snap ring. Requires 3/4" hole. Red or Black—specify color desired.
 Amphenol type 78-1P.
C12765—
Each 5¢

High Voltage Jack

13000 V. Tip Jack. As above but 1/2" diam. For xmitters, etc. Red or Black. Specify color.
 Type 78-1PI.
C12766—
Your Cost Each 7¢

Alligator Phone Tip Jack

(J) Alligator clip fitted with standard phone tip jack. Fits test prods equipped with phone tip ends. Red or black—specify color.
C12880—
Your Cost Each 25¢
 10 For \$2.24

Phono Tip Plug and Jack

(K) Single prong shielded plug used extensively for mike or phono pickup and other connections. The phono jack mounts in rear of panel through 3/4" hole and is 1/16" between centers.
C11773—Plug, Each 5¢
C11774—Jack, Each 8¢

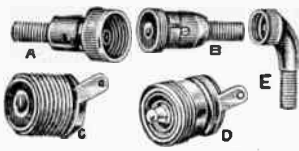

Single Contact Mike Connectors

Pressure type compact connectors for use with single conductor microphone cable—utilize shell for second contact. Contact is made when center soldered connections are pressed together by tightening coupling ring. Plated metal shells. Insulation is special tissue base laminated bakelite. Cable shield easily grounded through shell by soldering to cable protector. Accommodate cables up to 1/4" in diameter.

Type MC1F—Female cord connector. (A). **C13359—Each..... 32¢**

Type PC1M—Male chassis connector. Same as MC1M, but for chassis mtg. (C). **C13361—Each..... 19¢**

Type MC1F-A—Right angle female cord connector with spring cord protector. Use with PC1M, SP-PC1M or CL-PC1M. **C13277—(E)—Each..... 39¢**

Type MC1M—Male cord connector. (B). **C13360—Each..... 26¢**

Type SP-PC1M—Same as PC1M but with center contact floating on a heavy coil spring. (D). **C13385—Each..... 26¢**

Type CL-PC1M—Closed circuit chassis connector. Closes circuit automatically when mike is disconnected. (E). **C13268—Each..... 26¢**

Shielded Locking Type Microphone Connectors



MC series. With polarized shells. Can be used on 3/4"-27 stands. Locking ring on male, and cable clamps on both, with spring cord protector. Interchangeable bakelite elements. Coupled, 2 3/4 x 3/8".

3-Contact Connectors
C13489—Male (A) **65¢ Ea.**
C13490—Female (B) }
C13396—Female chassis type (C). For 1 3/16" hole. **32¢**

4-Contact Connectors
C13488—Male (A) **71¢ Ea.**
C13499—Female (B) }
C13397—Female chassis type (C). For 1 3/16" hole. **35¢**



Pin Connectors

Metal shells are heavily plated. Bakelite elements. Screw type coupling rings. Shells may be utilized for second conductor. For cable up to 1/4" dia.

Single-Conductor

C13286—Male (B) **42¢ Ea.**
C13287—Female (A) }
C13288—Female chassis connector. Mounts in a single 5/16" hole. (C). **26¢**

C12574—Female chassis connector with riveting plate. Single 5/16" hole mtg. (D). **32¢**

Two-Conductor

As above, but for 2-conductor cables and twisted pairs.

C13289—Female **52¢ Ea.**
C13290—Male }
C13292—Female chassis connector. Mounts in a single 5/16" hole. **29¢**

C12575—Female chassis connector with riveting plate. Single 5/16" hole mtg. **35¢**

ICA Shielded 3 Way Microphone Plug

Barrel made of nickel plated brass. Fully insulated bushing. **C13519—Each..... 85¢**
As above but with bakelite barrel. **C13521—Your Cost..... 59¢**

Popular Phone Plugs



For 1 or 2 phone or speaker cords. Molded bakelite shell. 2 3/4" long, 3/4" diam. Screw connections. **C14974**—Black **27¢**
C14971—Red. Each **27¢**
10 For..... **\$2.43**

Metal Shell Type

Same with nicked brass shell. 3 3/4 x 3/4". 10 For **\$4.41**
C14970—Each **49¢**

"Stubby" Metal Shell

As above but with short metal shell. 2 1/4" overall. 10 For **\$3.75**. **C14959—Each..... 42¢**

Midget Bakelite Plug

Bakelite shell. 2 1/4" overall x 9/16" diameter. Solder lug connections. **C14960**—Black **C14963**—Red **27¢**
Each **27¢**

Midget Metal Shell

Same with metal shell. 2 1/4" overall x 9/16" diam. 10 for **\$3.40**. **C14958—Your Cost..... 38¢**

U. S. Army and Navy Specification Plugs



Manufactured to meet the very exacting requirements of the U.S. Army Signal Corps and U.S. Navy Specifications. Will fit all standard jacks.

C14965—PL54. Short 2-way Plug. **1.03**
C14966—PL55 Long 2-way Plug. **50¢**
C14967—PL68 3-way Mike Plug. **1.03**
Your Cost Each..... **\$1.03**

Flat Plug

Ultra-compact type, for use where space is limited. Molded bakelite body. 1 1/16" dia., 3/4" thick. **C14964—Each..... 39¢**

Phone Plug Adapter



Makes a standard phone plug out of the MC1F cable connector. No soldering or wiring required.

C13388—MC1P **29¢**
Your Cost..... **29¢**

Microphone Switch



Attaches between male and female of any of the above connectors. Push to-talk or slide switch for permanent connection. **C13357**—MC1S **65¢**
Your Cost..... **65¢**

PLUGS and CONNECTORS

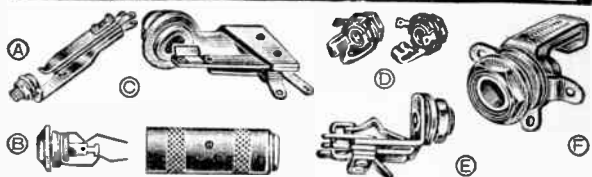

Long Frame Jacks

(A) Extend 3/8" behind panel. Pure silver contacts. Bakelite separators. No. 1. Open Circuit. **C6400—Your Cost..... 38¢**
C6401—No. 2 Circuit Closing. **C6402**—No. 2A. Two Circuit. **Either Type, Your Cost Each..... 47¢**

ICA Shielded 3 Way Jack

(B) Phosphor bronze spring jack. Nickeled brass shell. **C13520—Your Cost..... 88¢**
C13522—Jack, less shell **44¢**
Your Cost..... **44¢**

MALLORY Junior Jacks

(C) Compact, extend only 1 1/16" behind the panel. Heavily plated springs. No. 701—Open Circuit. **32¢**
C6450—Your Cost..... 32¢
C6451—No. 702. Circuit closing. **C6449**—No. 702A. Two circuit. **C6435**—No. 702B. Three circuit microphone. **44¢**
Your Cost, Any Type. **44¢**
C6452—No. 703. Single circuit filament control. **C6459**—No. 703A. Circuit reversing. **C6466**—No. 703B. 3-circuit Mike, one circuit closing. **50¢**
Your Cost, Any Type **50¢**
C6453—No. 704. Interstage **C6478**—No. 704A. 2-circuit filament control. **59¢**
Your Cost, Any Type **59¢**
C6479—No. 705. 2-circuit filament lighting. **68¢**
C6448—No. 706. Interstage filament control. **73¢**
Your Cost..... **73¢**

High Volt. Plugs & Jacks

(A) Heavy duty type, in medium and giant sizes. Handle 1000 volts at 10 amps. For use with high R.F. currents, diathermy work, x'mitters, etc. Insulated threaded heads and handles. Hardware furnished with jacks. Medium jacks for panels up to 3/8" thick; giant jacks for panels up to 3/4" thick. **Medium Plugs—2x1/2x3 3/8"**
C12870 blk. & red **32¢ ea.**
C12871—black }
Medium Jacks—2x3 3/8"
C12872—blk. & red **56¢ ea.**
C12873—black }
Giant Plugs—2x1 1/2x3 3/4"
C12785—blk. & red **44¢ ea.**
C12786—black }
Giant Jacks—2 1/4x3 3/8"
C12787—blk. & red **68¢ ea.**
C12788—black }

Signal Corps Type Jacks

(D) Phone Jack: Like Sig. Corps type JK-31A. Open circuit. Takes Mallory 75; W. E. 47A, 47B; Sig. Corps No. PL-47, PL-48, PL-55, PL-148, PL-155. **C6300—Each..... 32¢**
Mike Jack: Three circuit. Like Sig. Corps No. JK-33A. Takes W. E. 109; Sig. Corps No. PL-46, PL-68, PL-168. **C6301—Each..... 38¢**

MALLORY Midget Jacks

(E) Extremely compact. Mount in 3/8" hole. Type A-1 "Infant" jack is not illustrated. No. Part Type **Each**
C6182 A-1 Open Circuit **18¢**
C6183 A-2 Circuit Closing **28¢**
C6184 A-2A Two Circuit **32¢**
C6185 A-3A Cir. Reversing **47¢**

Grounding Jack

No. GJ-1—For grounding airplanes while re-fueling. Similar in construction to midget jack No. A-1, except for insulation. **C6339—Your Cost..... 26¢**

Midget Jacks

(F) Midget jacks of compact size, high quality, and low price. Fine grade bakelite insulation and tempered nickel silver springs. Mounts in 3/8" dia. hole in panels up to 3/16" thick. With mounting nut and washer. **C6548**—Closed circuit jack. **19¢**
C6549—Open circuit jack. **16¢**
New Imp. Short Jack. Fits standard 3-circuit mike plug. **C6550—Each..... 24¢**

MALLORY Plugs & Jacks

(B) No. 75. Two way. Bakelite shell. Tie cord anchor. **C6295—Each..... 38¢**
No. 75N. As above, but nickel shell. Tie cord anchor. **C6293—Each..... 59¢**
No. 75A. As above, with built-in cable clamp. **C6346—Each..... 97¢**
No. 100. 2-Way Extension jack. Fibre shell. **C6348—Each..... 76¢**
No. 100N. As above, but with nickel shell. **C6342—Each..... 97¢**
No. 100A. As above, with nickel shell, cable clamp. **C6349—Each..... \$1.35**

Microphone Plugs & Jacks

No. 76. 3-way mike plug. Bakelite shell. **C6296—Each..... 59¢**
No. 76A. Same, but with nickel shell. **C6347—Each..... \$1.15**

WALSCO Miniature Plug and Jack

Two-Conductor precision army type. Needs no screws. molded plastic case cements together. Ideal for hearing aids, speaker extensions, etc. **C14961**—1 plug (type PL-291) **24¢**
C14962—1 jack (type JK-48) **24¢**

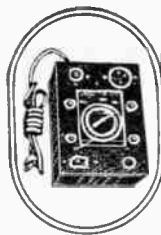

Power EQUIPMENT



MALLORY Vibrapacks

Flexible, heavy-duty vibrator power supplies for supplying high voltage direct current from a storage battery or similar d.c. source. For use with receivers, amplifiers, transmitters, etc., in marine, vehicular P.A., aircraft, police car, fire truck and similar applications. Four voltage outputs in 25 volt steps. Compact and light in weight (average shipping weight is approx. 10 lbs.). High efficiency reduces drain on batteries. NOTE: Two types are listed, self-rectifier and tube rectifier. "B" minus is at ground potentials in the self-rectifier types. Use the tube rectifier type for applications where "B" minus should not be grounded.

No.	Type	Vltg.	Output	Voltage	Output	Type	Each
C6090	VP-551	6.3	125-150-175-200	100 ma.	Self-Rect.	\$10.88	
C6094	VP-552	6.3	225-250-275-300	100 ma.	Self-Rect.	13.23	
C6091	VP-553	6.3	125-150-175-200	100 ma.	Tube Rect.	11.47	
C6095	VP-554	6.3	225-250-275-300	100 ma.	Tube Rect.	13.82	
C6066	VP-555*	6.3	300	200 ma.	Tube Rect.	27.05	
C6067	VP-557*	6.3	400	150 ma.	Tube Rect.	27.05	
C6092	VP-G556	12.6	225-250-275-300	100 ma.	Self-Rect.	13.82	
C6068	VP-F558	32.0	225-250-275-300	100 ma.	Tube Rect.	14.41	

*Special Dual Packs for high output. Output voltage not adjustable.
Type VF-223 Filter—For all single unit packs where utmost hum suppression and voltage regulation is required. C6060.....\$4.70

Replacement Vibrators for Vibrapacks

No.	Vibrapacks	Type	Each	No.	Vibrapacks	Type	Each
C6062	VP-551, 552, 540	725	\$4.50	C6064	VP-G556	G-725	\$5.32
C6063	VP-553, 554, 555†, 557†	825	3.67	C6065	VP-F558	F-826	4.06

†—Two vibrators required.

MALLORY VP—540 Filtered Vibrapack

A complete "B" power unit that operates from any 6 volt storage battery and delivers 250 volts at 60 ma., closely matching the power requirements of most auto, marine and aircraft receivers. The self rectifying unit is fully filtered. Complete with overall dust cover and special mounting bracket. Size: 7½"x3½"x5½". Wt. 9 lbs.

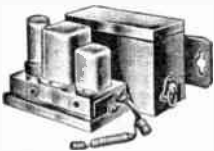

C6059—
Your Cost.....\$15.29

UTC Standard VARITRAN Voltage Controls

The VARITRAN is an ideal voltage control unit of the type employing a sliding contact riding over the transformer turns. They provide continuously variable output voltages FROM 0 TO 130 VOLTS without interruption of the circuit. Used extensively to control lights, line voltage, rectifiers, motors, transmitters, etc. Type V-1 (illustrated) is completely shielded and includes cord, plug, and switch. Other units are completely shielded and have screw terminals on an insulated strip. All units shown below for 115 volt input.

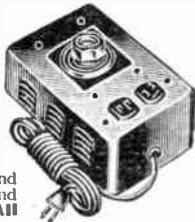

No.	Type	Watts	Amps.	Size	Wt.	Price
C5733	V-0	230	2	4 x 6 x 4½"	10 lbs.	\$11.27
C5771	V-1	570	5	5 x 8½ x 3½"	14 lbs.	17.15
C5716	*V1-M	570	5	5 x 10½ x 3½"	14 lbs.	28.42
C5772	V-2	570	5	5 x 7 x 4½"	13 lbs.	14.70
C5773	V-3	850	7.5	5 x 7 x 5½"	19 lbs.	21.56
C5774	V-4	1250	11	6½ x 9½ x 6"	37 lbs.	31.36

*Same as V-1, but includes 0-150 volt A.C. meter.

Sonic Vacuum-Tube Inverter

- ★No Vibrating Parts ★No Radiation
- ★Quiet Operation ★Speed Control
- ★Steady Voltage Output ★Powerful

The first really new and different idea in inverters. Changes 115 v DC to 115 v AC. Especially useful with radio-phonograph combinations where receiver is of AC-DC type and the phono motor of AC type. No vibrators or moving parts, inversion accomplished by vacuum tubes, thus eliminating the undesirable inherent noise of vibrator inverters. Constant voltage output and variable speed control insures faithful reproduction of recordings. Delivers ample power to maintain constant speed even through record changing cycle of automatic changers of the Garrard and Webster types.

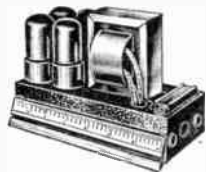

C17241—
Your Cost.....\$24.50

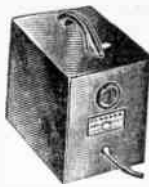

(A)



(B)



(C)

THORDARSON Automatic Voltage Regulators

(A) Continuous duty transformers which hold output constant to within ±1% regardless of line variations from 95 to 130 volts or load variations from no-load to full load. For 60 cycles. Line cord and plug for primary, receptacle on front for output.

Stock No.	Mfr's No.	VA	Wt. lbs.	Your Cost
C2129	T23V06*	20	12	\$29.40
C2129	T23V00†	40	18	33.81
C2130	T23V01†	100	48	38.22
C2131	T23V02†	250	68	52.92
C2132	T23V05†	500	76	79.38
C2134	T23V10†	1000	150	135.24

*Secondary 6.3 volts.
 †Secondary 110, 115, or 120 volts, as selected by switch on back.

THORDARSON Voltage-Changer Autotransformers

Change 220-250 volts, 50-60 cycle to 110-125 volts. Cont. duty. Line cord and plug for primary, standard line receptacle for secondary.

Stock No.	Mfr's No.	VA	Wt. lbs.	Your Cost
C2135	T23V21	80	5	\$ 5.88
C2136	T23V22	150	6¼	7.06
C2137	T23V23	250	10¼	8.82
C2138	T23V24	500	13	11.76

Adjust-A-Volt VARIABLE TRANSFORMER



This easily controlled rheostat type of voltage regulator plus a high efficiency transformer fills the need for a portable heavy duty unit.

Adjustment provided by means of a self-lubricating moving contact which taps turns of the winding. Output voltages obtainable from two ranges: 0 to 140 volts, and from 0 to 280 volts. Output is independent of load. Units are ruggedly constructed, well ventilated and made to operate on 50-60 cycles. Control on panel has calibrated scale. Provides smooth control of voltage to regulate: AC lines, power, heat, light and speed devices. All rated at 860 V.A.

Stock No.	Input Volts	Output Volts	Wt. lbs.	Price Each
C1990	115	0-140	25	\$17.15
C1991	230	0-280	25	24.99
C1992	230	0-140	37	22.05

Isolation Types

Constructed similarly to the above, but have isolated primaries. Husky cores and windings, smooth continuous control plus fuse protection guarantee continuous operating service. Used in any application requiring from 70 to 140 volts. Useful to servicemen to detect faulty oscillators by dropping line voltage to 105 volts or to check breakdown intermittent part by increasing voltage to 130 or 140 volts. Both rated at 500 V.A.

Stock No.	Input Volts	Shgp. Wt.	Price Each
C1993	115	25 lbs.	\$23.03
C1994	230	25 lbs.	24.01

ELECTRO Model "A" DC Power Pack

(B) 6 or 12 volts. To demonstrate or repair auto, marine, or aircraft radios. Plugs into 60 cycle line, primary taps for 105, 115, 125v. Two separately filtered and fused 6v outputs, each 7½ amp. Use separately, or in series for 12v, or in parallel for 6v, 15 amp. Will furnish 20 amp intermittent to operate relays and solenoids. Bridge rectifier, chokes, two 2000 mf condensers. Negligible ripple. Steel cabinet, blue hammerflood finish. Line Cord+Plug 7½"H, 7¾"W, 11¾"L. Shpg. wt. 31 lbs. **C15703—**
Your Cost.....\$38.22

E-L Model 976 Rectifier Pack

(C) 6.3VDC, 7 amp, continuous output from 115VAC, 60 cy. input. Fused and filtered. Use as trickle charger, or to demonstrate and service auto radios, defroster fans, heaters, etc. 6¾"W, 8½"L, 6¾"H. Shpg. wt. 13 lbs. Line cord + plug. **C17249—Each. \$20.55**

E-L Inverter



Model 307—Input 6 VDC; output 115 VAC 60 cps, 100 watts max. At rated load 67% efficient and 37.1% regulation.

Carefully filtered to eliminate RF noise from 550 KC to 20 MC. Ruggedly constructed to withstand severe shock or sudden jar. Complete with vibrator, and 5 ft. battery cable with clips. Size: 10¾"x7½"x8¼". Net. wt. 23½ lbs. **C17248—**
Your Cost.....\$23.52

ATR Inverter



This newly developed line of DC to AC inverters is especially recommended for operating AC Radios, Public Address Systems, Amplifiers, etc., from DC voltages. Extremely well filtered to insure interference-free all-wave radio reception. All models listed below have 110 volt 60 cycle AC output. Standard Models measure 7½"x8¾"x4½", shipping weight, 17 lbs. Heavy Duty Model measures 7½"x9¾"x6¼", shipping weight 26 lbs.

Stock No.	Volts	Watts	DC Input	AC Cont.	YOUR COST
C17242	6	85	75		\$22.34
C17243	12	125	100		22.34
C17244	32	150	100		23.23
C17245	110	325	150		33.52
C17246*	110	325	225		33.52
C17247	220	250	150		24.70

Vibrators for Above

C6048—For 6V models.
Your Cost.....\$5.00
 C6049—For 110 V models.
Your Cost.....\$5.00

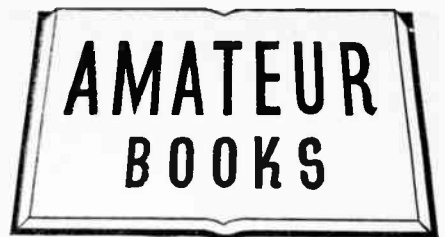
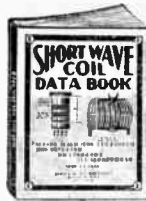

CQ-DX Handbook

First Edition. Published by CQ-Radio Magazines, Inc. Written by and for hams. Lawrence LeKashman, editor. 16 chapters covering essentials and operating techniques of working DX, DX predictions, WAZ system, international time tables and chart, world and country lists, Q codes and miscellaneous information calculated to be of help to amateurs who wish to become DXers. Great Circle direction charts and Great Circle maps centered on principal U.S. cities. Varnished paper binding. 6 3/4 x 9 3/4". 104 pages.

C19953—Your Cost... **50¢**

First Radio Book For Boys

By Alfred Morgan. Complete basic radio theory written in the simplest terms. Includes construction details for crystal sets, one- and two-tube receivers, a simple phono oscillator, etc., and how to learn the International Morse code and obtain a license. 5x8". 192 pages, illustrated.

C20256 Postpaid... **\$2.50**
Your Cost...

Radio Operating Questions and Answers

By Nilson and Hornung. Latest edition. Has over 400 pages of typical radio operator license examination questions with answers. Covers spark, arc and tube transmitters; batteries, generators, broadcasting, shortwave, radio-compass, etc. 5x7 1/2". Shpg. wt. 2 lbs.

C19943—Postpaid... **\$3.43**

Practical Radio Communication. By Nilson and Hornung. Covers receiving, transmitting and practical design. Over 751 pages. Postpaid... **\$6.37**
C20020—Your Cost

Radio Operators' License Manual

By Wayne Miller. 1943 Edition of question and answer manual on radio operator license examinations. Has answers to all questions appearing on exams for commercial radio telephone and telegraph licenses. 6x9". 211 pages.

C20290—Postpaid... **\$3.00**

"RADIO" Handbook

Revisions in this new Eleventh Edition adapt it for basic training and general use to a greater extent than ever before. Contains added and simplified theory in the clearest possible language; test equipment, home or field-constructed, and a review of mathematics for solving radio problems. More than 600 pages, durably cloth-bound, gold-stamped. Radios' outstanding practical text for radio training and regular purposes.

C20000 Postpaid... **\$2.50**
Your Cost...

Hathaway and Gorder's "Radio Fundamentals"

The latest volume in the American Technical Society's excellent series. Designed thoroughly to acquaint the reader with basic radio and electrical theory and practice from crystal receivers to Frequency Modulation. Written with exceptional clarity and simplicity, it will prove a boon to those seeking a thorough, easily understandable book on radio.

C19980—Postpaid... **\$2.94**
Your Cost

S-W Coil Data Book

How to make your own short-wave coils. Method of computing wire size, turns, forms, spacing. No duplication.

C19985—Your Cost... **25¢**

Radio Operator's Code Manual With Touch Typing

By Wayne Miller. An outstanding book embodying the most recently developed method of teaching the continental Morse radio telegraph code. For home-study and classroom use to teach code and touch-typing with a minimum of effort. 6x9". 144 pages.

C20291—Postpaid... **\$2.00**

Radio Amateur Newcomer

Everything necessary for the newcomer to understand simplified basic theory, obtain his license, build simple equipment, and get on the air. 128 illustrations. 160 pages, 6x9".

C20022—Postpaid... **\$1.00**



A.R.R.L. Antenna Book

A comprehensive manual of antenna design and construction. Contains 18 full chapters profusely illustrated. Includes theory and practical data on all types. Over 100 pages.

C19721—Postpaid... **50¢**

A.R.R.L. Log Book

The law requires that amateurs maintain a log. This one is spiral bound, has 31 log pages, 31 note pages, "Q" signals, graph paper, message number sheet. Postpaid.

C19946—Your Cost... **35¢**
Each... **\$1.00**

How to Become a Radio Amateur

A thorough easy-to-read booklet covering the subject of entering the amateur ranks. Explains elementary theory, construction of inexpensive stations, "code" laws, operating procedures, etc. A.R.R.L. publication. Latest revised edition.

C19935—Postpaid... **25¢**
Your Cost

Learning the Radio Code

Designed to train students to handle code skillfully employing accepted method of "sound" conception. Helpful home study material for members of code classes. Adequate practice material included for classwork.

C20006—Your Cost... **25¢**
Postpaid

A.R.R.L. Radio Amateur's Handbook—Latest Edition

Newest edition of this famous handbook. Contains as always complete fundamental data, constructional information on transmitters and receivers of latest design, and a great deal of new material designed to make it even more valuable than ever before. 5-18 pages, 900 diagrams, charts.

C19949—Postpaid... **\$1.25**
Your Cost

The Radio Amateur's License Manual

How to get your licenses, made easy. Includes complete questions and answers for the new Class A, B and C examinations. Latest edition. 29 pages.

C19940—Postpaid... **25¢**
Your Cost

Course in Radio Fundamentals

A new ARRL book prepared in response to the demand for a course of study emphasizing the fundamentals on which practical communication is built. For best results should be used in conjunction with the ARRL Amateur's Handbook. Material is divided into 36 assignments with a series of questions designed to bring out significant points in the text.

C20211—Postpaid... **50¢**
Your Cost

Hints and Kinks

Volume Two. 128 pages of selected practical money-saving ideas. Numerous diagrams and illustrations.

C19981—Postpaid... **50¢**

Manly's Radio and Electronic Dictionary

Defines 3800 terms in alphabetical order. 300 pages 6x9". 550 illustrations. Maroon binding. Shpg. wt. 3 lbs.

C19939—Postpaid... **\$2.62**

Books For Young Radio Experimenters

For the beginner in radio and electricity. Tells how and why in simple language. 5x6 1/2".
C19975—No. 1. How to Build 4 Doerle Short-Wave Sets.
C19970—No. 2. How to Make the Most Popular All-Wave 1- and 2-Tube Receivers.
C19972—No. 3. Alternating Current for Beginners.
C19998—No. 4. All About Aerials.
C20008—No. 5. Beginner's Radio Dictionary.
C20009—No. 6. How to Have Fun With Radio.
C20010—No. 7. How to Read Radio Diagrams.
C20011—No. 8. Radio For Beginners.

C20003—No. 9. Simple Electrical Experiments.
C20004—No. 10. Television.

Any above... **10¢**

Your Cost Each... **40¢**

5 for... **75¢**

10 for...

Radio-Craft Library Series 10 New Books

Each in this new series is crammed full of meaty material for immediate, practical application. All are set in modern easy-to-read type, carefully printed and illustrated. Postpaid.

C19910—Handy Kinks and Short Cuts.

C19911—Unusual Patented Circuits 1944-46.

C19912—Radio Questions and Answers.

C19913—Advanced Service Technique.

C19914—Amplifier Builder's Guide.

C19915—Radio Electronic Circuits.

C19916—Amateur Radio Builder's Guide.

C19917—Radio Test Instruments.

C19918—Elementary Radio Servicing.

C19919—How to Build Radio Receivers.

Any above... **50¢**
Your Cost, Postpaid

Radio Amateur Call Book

Issued March, June, September and December. Contains a complete up-to-date list of all licensed radio amateurs throughout the world. 8 1/2 x 11 1/4". New postwar issue.

C19936—Your Cost... **\$1.50**

RADIO ENGINEERING BOOKS



How Electronic Tubes Work

A G.E. book that fully illustrates and explains the functions of the heater, cathode, anode, grid, etc. Explains the difference between the gas-filled and high-vacuum tubes (space charge and ionization). Explains the Kenotron, Plotron, Phanotron, Ignitron, Glow Tube, etc. 23 pages. **C19979—Your Cost . . . 15¢**

The Ignitron Tube and how it is used. C19982—Postpaid. . . 15¢

RCA Receiving Tube Characteristics Chart. C19984—Postpaid . . . 5¢

RCAPT-20R1 Phototube Book. C20226—Postpaid. . . 5¢

Each Power & Gas Tubes. C19986—Your Cost . . . 5¢

Mathematics for Radio and Communication

By Maedel. Written by the chief instructor for the RCA Institutes in New York. Used as official texts. Vol. 1 covers Arithmetic, Algebra, and Geometry. Vol. 2 covers Advanced Algebra, Trigonometry and Complex Numbers. **Postpaid. C19676—Vol. 1. \$3.75**

Your Cost . . . C19677—Vol. 2. 4.00



TELEVISION—The Eyes of Tomorrow

By Capt. William S. Eddy. Explains how television works and how television shows are produced. It goes into programming, acting, lighting, sets and make-up. Discusses color television and other new developments. Also includes the history and economic aspects of the industry. A "must" for everyone interested in this wonderful new art of communication. **Postpaid in U.S.A. C20297—Your Cost . . . \$3.67**

"TELEVISION"

By V. K. Zworykin and G. A. Morton. A book on radio's newest developments, written in direct clear-cut English by two of the most famous men in the field. 616 pages. 494 illustrations. **Postpaid. C19789—Your Cost . . . \$6.86**

Practical Mathematics

By Hobbs-Dalzell-McKinney. A very practical "how-to-do-it" book dealing with the fundamentals of mathematics. From the beginning to Roots, Equations, Graphs and Logarithms; includes six place log tables and questions and answers. 599 pages. Shipping wt. 3 lbs. **C20280—Your Cost . . . \$2.69**

Your Cost . . . \$2.69

Fundamentals of Vacuum Tubes

By A. V. Eastman. New second edition covering all types of vacuum tubes from diodes to the most complex modern multigrad tubes. Also covers industrial types such as thyatrons, mercury arc rectifiers, etc. 584 pages. 6x9". Shipping wt. 3 lbs. **Postpaid. C20250 . . . \$4.90**

JENSEN Technical Monographs

First five booklets of a series in the interest of improved sound reproduction. Up-to-date factual information, replete with useful charts, graphs and tables, they supply a wealth of data to guide in the selection, installation, and operation of loud-speakers. **Loud-Speaker Frequency-Response Measurements. C19905—**

Impedance Matching and Power Distribution. C19906—

Frequency Range in Music Reproduction. C19907—

'The Effective Reproduction of Speech. C19908—

Horn-Type Loud-Speakers. C19909—

Your Cost Each . . . 25¢



Slide Rule Simplified

By C. O. Harris. A popular, yet scholarly presentation on this most useful instrument. Takes the mystery out of the slide rule. 266 pages, well illustrated and bound. With a genuine Dietzgen 10" slide rule. Shipping wt. 5 lbs. **Postpaid. C20281—Your Cost . . . \$3.92**

Book alone, less slide rule. C20282—Postpaid. \$2.69

Your Cost . . . \$2.69

Mathematics for Electricians and Radiomen

By Nelson M. Cooke, Chief Radio Electrician U.S.N. Teaches you mathematics from elementary algebra through quadratic equations, logarithms, trigonometry, plane vectors, and elementary vector algebra with direct applications to electrical and radio problems. 600 illustrated problems, worked out in detail, provide 3000 problems with correct answers to check your progress. Only the knowledge of arithmetic is necessary in order to use this book. 604 pages. 6x9". **Postpaid. C20246—Your Cost . . . \$4.41**

Your Cost . . . \$4.41

U.H.F. Radio Simplified

By Milton S. Kiver. In this book U.H.F. radio is simply explained in easy-to-understand language. From the first page to the last, this book is organized in every detail to assure your progress from every-day (low frequency) radio to a thorough command of the principles and practice of U.H.F. work. Take advantage of this opportunity to familiarize yourself with such U.H.F. subjects as: Klystrons, wave guides, cavity resonators and U.H.F. antennae. 242 pages. 5½x8¾". **C19988—Your Cost . . . \$3.18**

Radio Engineering Handbook

By Keith Henney. This book contains a wealth of essential theory, practice and data. Especially suited for the engineer dealing with all electronic problems. Highly authoritative information on such subjects as: antennas, U.H.F. circuits, Television, facsimile, etc. Consult this book for authoritative facts and data on problems of design, research, and construction of electronic equipment. Volume 3. 954 pages. Shipping wt. 2 lbs. **Postpaid. C19983—Your Cost . . . \$5.88**

Your Cost . . . \$5.88

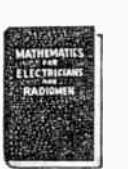

Radio Engineering

By Terman. Comprehensive engineering treatise covering important vacuum tube and radio phenomena. A technical book for technicians men. 688 pages. 418 illustrations. **Postpaid. C20221—Your Cost . . . \$5.88**

Your Cost . . . \$5.88

Photocells and Their Application

By Zworykin and Wilson. 2nd edition. 348 pages covering theory and practice including television, talkies, facsimile, etc. Shipping wt. 4 lbs. **Postpaid. C19886—Your Cost . . . \$3.43**

Your Cost . . . \$3.43

Radiotron Designers Handbook

By F. Langford Smith. Sponsored by RCA. For the set designer but of value to all engineers, servicemen and students. 365 pages. **C19680—Your Cost . . . \$1.22**

Your Cost . . . \$1.22

FM Simplified

By Kiver. Covers basic FM theory, interference reduction properties of FM. Theory and operation of three methods of FM detection. Complete analysis of typical FM receiver. Servicing, Alignment. **C19974—Your Cost . . . \$5.88**

Your Cost . . . \$5.88

Mallory Vibrator Data Book

Only one of its kind. Answers all questions about vibrator power supply design and servicing. Deals with Basic vibrator structures, selection of correct vibrator, transformer design, specification, characteristics, power supply circuits, inspection, design practices and vibrator data sheets. A "must" for the serviceman, design engineer or experimenter. **C19992—Your Cost . . . 98¢**

Your Cost . . . 98¢

Principles of Radio

Fourth Edition. By Keith Henney. Easy-to-read, comprehensive style for use by the beginner and student new to radio and electronics. Covers fundamentals, various electrical and radio laws, theory behind operation of tubes and radio circuits, design of amplifiers, receiving systems, rectifiers, antenna systems. Minimum of mathematics and worded in such manner as to be readily understood. Receiving tube characteristics and relation between wavelengths and frequency on inside front and back covers. Hard cloth covers. 549 pages. 5½x8". Shipping wt. 3 lbs. **Postpaid. C19736—Your Cost . . . \$3.67**

Your Cost . . . \$3.67

TELEVISION Simplified

By Milton S. Kiver. Practical Television explained without involved theory or mathematics. Especially written for radio servicemen, radio workers and set owners. Principles and practices governing Modern Television covered in concise, to-the-point wording. Practical chapters include: Cathode Ray Tubes, Color Television, Typical Television Receiver and Servicing Television Receivers. **C19990—Your Cost . . . \$5.88**

Your Cost . . . \$5.88

Frequency Modulation

By August Hund. Here is an engineering treatment of frequency modulation, covering both basic principles and the design of commercial apparatus. The phenomena and features of frequency and phase modulation are described in a thorough approach that includes comparison with customary amplitude modulation, following with application in FM transmitters, receivers, auxiliary apparatus, and antennas are fully discussed. The use of tables and curves to simplify design is also emphasized. 375 pages. 6x9". 113 illustrations. **Postpaid. C19989—Your Cost . . . \$4.41**

Your Cost . . . \$4.41



SERVICING BOOKS

3rd Edition Radio Troubleshooter's Handbook

"Case histories" of over 4,600 receivers and automatic record changers! 50-page tabulation of IF peaks of 20,173 superhets and alignment data for practically every superhet known! 60 pages of auto radio charts and data! Covers 1,250 portable radio models! 20-page tube chart! And loads of other information covering manufacturer's names, data on ballasts, pilot lamps, tube testing, magnet wire, tuning coils, grid bias resistors, condensers, transformers, parallel and series networks, decibels, volume and tone controls, filters, conversion factors, reactance charts, servicing data, etc., etc. 710 pages. 8 1/2"x11" in size. C19959—**Postpaid in U.S.A. \$5.00** SAVE MONEY! Order the above and C19958 together. **Shipped postpaid in U.S.A. \$9.50** Both For.....

Drake's Cyclopedia of Radio and Electronics

Practical reference book of radio transmission and reception, public address, sound pictures, photocells, television and short wave. Latest revised edition. 764 pages, 9x6 1/2". Wt. 4 lbs. **Postpaid, C19938—Your Cost \$4.50**

Modern Radio Servicing

The latest edition. This comprehensive volume gives a 1300 page course on latest "factory" methods; servicing radios of all kinds; how to construct and operate modern test equipment; trouble shooting; repairing; locating and eliminating noise; cathode ray aligning; auto radios, etc. Profusely illustrated, 700 diagrams, charts, photos, etc. Shpg. wt. 5 lbs. **Shipped Postpaid in U.S.A. C19958—Your Cost \$5.00**

Principles and Practice of Radio Servicing

By H. J. Hicks
Definite instructions for performance of all the more complicated servicing procedures. Covers test equipment, signal tracing, frequency modulation and modern antennas. Includes a worthwhile chapter on getting and retaining radio servicing business. Fully illustrated, 391 pages. 6x9". Shpg. wt. 3 lbs. **Postpaid, C19735—Your Cost \$3.92**

Electrolytic Capacitors

Author is chief-engineer of Cornell-Dubilier Electrolytic Division and an authority on this subject. Well illustrated, 300 pages. **Postpaid, C19727—Your Cost 98¢**

GHIRARDI'S Radio Physics Course (Latest Revised Edition)

This famous text has long been the radio "bible" for teaching fundamentals of radio and television to beginners and students. 972 pages with over 500 illustrations covering every phase of radio, public address, talking pictures, television, photocells, elements of a.c. and d.c. electricity. Used in schools everywhere. Cloth binding. **Shipped postpaid in U.S.A. \$5.00 C19897—Your Cost**

Radio Service Trade Kinks

By L. S. Simon
Full of valuable short cuts and hints on where to look for radio troubles and what to do about them. 269 pages. 8 1/2"x11". Shpg. wt. 1 lbs. **Postpaid \$3.43 C19732—Your Cost**

Elements of Radio

By A. Marcus
Covers the basic principles and the application of radio theory. Written in terms that the average reader can understand with scores of easy to follow illustrations. 699 pages. **Postpaid in U.S.A. C20259—Your Cost \$3.92**

Twin "Trouble-Shooter Gadgets"

Two remarkable, ingenious radio set "trouble finders." A flip of the card and for any trouble symptom you find not only the cause and the location of the trouble but the remedy as well. Made in pocket size. **C19932—Home Radio Sets C19933—Auto Radio Sets Postpaid in U.S.A. 50¢ Each.....**

R.C.A. Service Manuals

Revised and abridged edition of all R.C.A. Victor Service Notes from 1938 to 1942, inclusive. Here, in one volume, are the notes the serviceman needs to repair R.C.A. radio-receivers, phonographs and combinations. Handsomely bound in red deluxe vellum book covering lettered in gold. Volume 2, 816 pages. **C19902—Vol. 11, 1938 to 1942. C19901—Vol. 1, Data from 1923 to 1937, inclusive. 880 pages. Your Cost either postpaid \$6.00**

MYE Technical Manual

A practical, simply written book that bridges the gap between theory and practice. Designed for the Serviceman, Engineer, Amateur or Experimenter. Hard cloth covers. 392 pages, 8 1/2"x11". Permanent sewed binding. **C19780—Your Cost \$1.96**



Electrician's Handbook by COYNE

A practical book for Electrical workers. Contains up-to-the-minute rules, laws, tables, wiring methods, etc. Gives over 5,000 electrical facts as well as the latest changes in the National Electrical Code. Also includes tested plans for plant and electrical system improvements. Diagrams and illustrations galore. A "must" for the electrical worker who wants to get ahead. **Postpaid in U.S.A. \$2.75 C20293—Your Cost**

ELECTRONICS

This valuable book by Coyne is a handy fact packed manual written in a thoroughly practical easy-to-understand language. Describes the different kinds of tubes, their applications, servicing, testing and trouble shooting. Diagrams and illustrations galore. 412 pages. **Postpaid, C20292—Your Cost \$4.95**

R.C.A. Receiving Tube Manual

Complete technical data of all glass and metal receiving tubes. Contains: curves, charts, circuits and socket diagrams. 192 pages; 5 1/2"x8 1/2". An essential for every radioman. **C19963—Your Cost 35¢**

Refrigeration Manual

Explains construction and operation of complete systems and of all their parts, also instructions relating to installation, testing, trouble-shooting, adjustment and repair. Includes 23 tables devoted to causes and remedies for easily recognized symptoms of faulty operation. Very simply and directly written, with 138 diagrams and illustrations. 300 pages. Shpg. wt. 2 lbs. **Postpaid, C20298—Your Cost \$1.96**

COYNE Dictionary and Data Book

Handy vest pocket dictionary and data book for personal use. Includes definitions and data on electricity, radio, electronics, radar, and also information on the language used in the study or application of atomic energy. All words arranged in one continuous alphabetical order. 304 pages. 3x6 1/4". Red simulated morocco binding. **Postpaid in U.S.A. C20209—Your Cost \$1.00**

How To Make Good Recordings

Explains how to make "commercial quality" recordings. Tells all the "tricks" used by the experts. Describes equipment, needles, discs, turntable drives, etc. Profusely illustrated. 5 1/2"x8 1/4". **C19991—Your Cost 90¢**

Techniques of Recordings

By Goldsmith and Geisel. Fundamentals of recording. 16 chapters, illustrated, dealing with functions of recording, for the beginner and the advanced recordist. Shpg. wt. 1 lb. **C20268—Your Cost 75¢**

COYNE Radioman's Handbook

Practical reference book for radio workers. Up to the minute with the latest in radio developments in such simplified form that the data is quickly available for use on the job. Contains complete easy to follow formulas, methods, charts, rules, diagrams, circuits, laws, tests, emergency repair data, definitions and designs. 355 pages 4 1/2"x7 1/2". Simulated morocco binder. **Postpaid, C20210—Your Cost \$2.75**

Wiring Diagrams For Light and Power

Contains valuable data and easy-to-read diagrams for wiring practically every type of electrical apparatus. Covers house wiring, meters, relays, motors, switchboards, etc. 210 pages. Pocket size. **Postpaid, C20295—Your Cost 98¢**

Armature and Magnet Winding

270 well illustrated pages. Complete tables. For a.c. and d.c. Answers all questions clearly and concisely. Highly practical. Sturdily bound. Shpg. wt. 1 lb. **Postpaid, C19719—Your Cost \$1.25**

MALLORY-YAXLEY Encyclopedia 5th Edition

Latest, biggest, most valuable issue. Contains all the essential service information on all pre-war receivers, including all the makes and models listed in former MYE's plus an additional 4000 sets. A 25% increase in the number of new listings, makes it the largest publication ever printed containing complete, accurate replacement information on all major radio components. Incorporates all references up to and including Rider's Volume XIV. **C19786—Your Cost \$1.25**

RIDER AND SUPREME SERVICING BOOKS



RIDER'S Service Manuals

Now more than ever before you need a complete set of Rider's Manuals with its authoritative information on the latest sets.

Vol. 16—Approximately 768 pages of circuit diagrams and Service data with "Classified Schematics" breakdown of Multi-band receivers. "How it works" book and separate index included. With 8½" by 11" loose-leaf post binder.

C20036—Your Cost \$6.47

Volume 1-5—A new abridged volume taking the place of the five original individual volumes. All the important sets from 1930 to 1935 in one giant 2000-page volume.

C19684— \$17.15

No.	Volume	Year	Price
C20027	15	46-47	\$17.64
C20025	14	1942	14.70
C20026	13	Late '41	14.70
C19784	12	Early '41	14.70
C19898	11	Late '40	14.70
C19738	10	Early '40	14.70
C19893	9	1939	14.70
C19892	8	1938	14.70
C19951	7	1937	14.70
C19942	6	1936	10.78

Master Index

204 Pages 8½x11" Covering Rider Manuals, Volumes I thru XV. Sturdy Paper Covers.

C20037—Your Cost \$1.47

Record Changers & Recorders

All the information you need to repair these highly complicated mechanical marvels. Sharp, clear pictures illustrate every phase of operation. 744 pages, same size as other Rider manuals.

C19642— \$8.82

RIDER Text Books "Hour a Day with Rider"

Start from the beginning with John Rider as your personal instructor and really learn theory and practice. Each book is written in simple language, is sturdily and handsomely bound and profusely illustrated. Each text measures 8½x5½". A real profitmaker for the serviceman.

C20030—Alternating Currents in Radio Receivers.

C20031—On Resonance and Alignment.

C20032—D.C. Voltage Distribution in Radio Receivers.

C20033—On Automatic Volume Control.

Your Cost Each, \$1.22
Any Above Titles . . .

"Cathode Ray Tube at Work"

338 profusely illustrated pages covering theory and application of the C-R tube.

C20017—Each . . . \$3.92

THE METER AT WORK. Book is cleverly arranged with text separated from the illustrations. 152 pages.

C20058—Each . . . \$1.96

THE OSCILLATOR AT WORK. Covers all types of signal generators and oscillators. 256 pages.

C19739—Each . . . \$2.45

VACUUM-TUBE VOLT-METERS. Includes theory and practice. 180 pages.

C19783—Each . . . \$2.45

Frequency Modulation

More and more F.M. transmitters are going on the air—manufacturers are selling the special receivers and converters for picking up these signals. This book tells how to service these receivers and converters. 136 pages. 5½x8".

C19745—Each . . . \$1.96

RADAR

What it is . . .

By Rider and Rowe. A fact filled book that is a non-technical explanation of radar principles. Explanatory details of how radar works with thrilling accounts and vivid descriptions of how it was actually used.

C20035—Your Cost . . . 98¢

A.C. Calculation Charts

By R. Lorenzen. 146 charts 7x11" printed in two colors, covering all alternating current calculations in series-parallel and mesh circuits, at frequencies from 10 cycles to 1000 megacycles. A tremendous time-saver for engineers and others who work on electrical communication and electrical power problems. Each book contains a transparent straight edge.

C20267—Each . . . \$7.35

Servicing by Signal Tracing

Tells how to locate troubles in receivers quickly and accurately. Actual signals used for localizing and determining set ailments. 360 pages.

C19737— \$3.92

Servicing Superheterodynes

Covers theory of all types of superhets and answers all questions pertaining to their servicing. 288 pages.

C19927—Your Cost \$1.96

Automatic Frequency Control Systems. Theory, as well as breakdown analysis in commercial sets. 144 pages.

C20007—Your Cost \$1.71

Aligning Philco Receivers. Vol. 1: Authoritative collection of alignment data covering every Philco Set. 176 pages.

C19975—Each . . . \$1.96

Vol. 2: 1937 to 1941. 200 pages. Postpaid.

C19709—Your Cost \$1.96

Servicing Receivers by Means of Resistance Measurement. How to localize set troubles with an ohmmeter, 203 pages.

C19928— \$1.96

Your Cost . . . \$1.96

NOTE

ALL BOOKS ON THIS PAGE SHIPPED POSTPAID IN U. S. A. ONLY

Inside the Vacuum Tube

By John F. Rider. This is not just another book about vacuum tubes; its prime purpose is to present a solid understandable concept of theory and operation of the basic types of tubes as a foundation upon which can be built a more advanced knowledge of tubes in general. It explains clearly load lines, plate and grid characteristics, curves, and many other things about vacuum tubes. With spectacles for viewing anaglyphs in three dimensions. 430 pages.

C20034—Your Cost \$4.41



Most Often-Needed Radio Diagrams

Helps you repair radios quickly, properly, and efficiently. Follow the factory instructions given in these manuals. Easy to use and inexpensive. Lists 4 out of 5 circuits you will ever need. Complete with alignment data, service hints, I. F. peaks and replacement parts lists. Also includes data on F.M. portables, recording, etc. Diagrams galore. Information given is both time-saving and money-making. Fact-packed pages. Each volume is 8½x11".

No.	Vol.	Year	Pages	Price
C20244	7	1947	192	\$2.00
C20230	6	1946	192	2.00
C20227	5	1942	192	2.00
C19674	4	1941	192	2.00
C19673	3	1940	208	2.00
C19672	2	1939	192	2.00
C19710	1	1926-1938	240	2.50

Index to First 6 Volumes

C19708 . . . 25¢

C20237—Stewart-Warner Manual . . . 50¢

C20238—General Electric Manual . . . 50¢

C20239—Arvin Manual . . . 50¢



Radio Electronics Home Study

New home study course on radio, electronics and radio servicing in 3 volumes. Covers parts, tubes, circuits, home radios, communication sets, transmitters and television. Also photo cell equipment, electronic heating, welding controls, radio compass, test equipment, superhets, recording, intercoms, frequency meters and many other branches of electronics. Case histories, charts, pictures and diagrams included. Individual volumes not sold separately as this is a comprehensive course.

C20276— \$3.95

3 volumes in one. Your Cost . . .

C20274— \$2.5¢

Answer Book for above course. Your Cost . . . 25¢

Post War Automatic Record Changer

The very latest information on operation and adjustment of all makes of prewar and postwar automatic changers. 8½x11". 144 pages.

C20249—Your Cost \$1.50

Refrigeration

Hints, ideas, suggestions in the repair, adjustment, of all domestic units.

C20273—Your Cost \$1.00

Radio Mathematics

Introduces and explains arithmetic and elementary algebra in connection with units, color code meter scales, Ohm's law, alternating current, ohmmeter testing, wattage rating, series and parallel connections, capacity, inductance, mixed circuits, vacuum tubes, curves, the decibel. Numerous examples. Plainly written for the non-technical person. 32 pages. 5½x8½".

C20272—Your Cost . . . 25¢

Radio Servicing Course

Written in a simple, straight from the shoulder manner which is easily understood by all. Commercial practices and equipment clearly described. 224 pages. 8½x11". Shpg. wt. 2 lbs.

C20234— \$2.50

Your Cost . . . \$2.50

Cyclopedia of Television Facts

New television book defines and explains every term and part used in television transmitting and receiving equipment. More important terms explained in detail. Well illustrated. 48 fact-packed pages. 5½x8½ inches.

C20271—Your Cost . . . 40¢

Radio Servicing by Comparison

Introduces you to a remarkably simplified technique of radio repairing—the comparison method. Written in a down-to-earth manner. Illustrations and diagrams galore.

C20235—Your Cost \$1.50

Each . . . \$1.50

Record Player Manual

Diagrams and instructions for repairing automatic record changers, pickups, wireless oscillators, recorders and combiners. 132 large pages. 8½x11".

C20232—Your Cost \$1.50

HOWARD W. SAMS Radio "PHOTOFACT" Service Save 50% of Servicing Time!

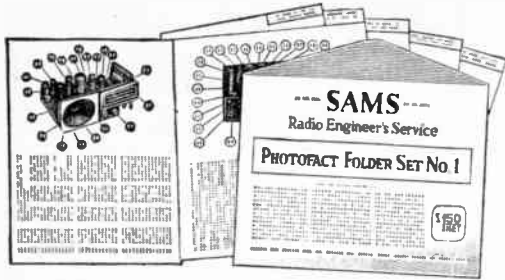

The time to have information about new receivers is when they reach the market. This is the service that the PHOTOFACT folders give to you, usually before the RMA guaranty period has expired. There is no reason to have to wait a year or to thumb through a cumbersome cross index to find obscure facts on servicing. Here is the information you receive in this new, fast, efficient manner:

Analytical data obtained from actual work on each receiver. Photos on each chassis from numerous angles to assure easy identification of parts. Voltage and resistance measurements at each tube prong. Physical and electrical specifications, plus available part replacement numbers, of all components. Data on alignment procedure, stage gain and other specific information. Each envelope contains at least 30 folders and many times as many as 50, wholly depending on the complicated nature of the receiver. Tests show that PhotoFact saves half of your time when servicing. The purchase of group No. 1 will automatically give you a membership in the Howard W. Sams Radio Institute. Practical answers to any question about radio service will be handled by thirty specialists. Send for your folders now.

No.	Set	No.	Set	No.	Set
C19787	1	C19779	10	C19657	19
C19790	2	C19775	11	C20350	20
C19791	3	C19776	12	C20351	21
C19795	4	C19650	13	C20352	22
C19796	5	C19651	14	C20353	23
C19797	6	C19652	15	C20354	24
C19799	7	C19653	16	C20355	25
C19777	8	C19654	17		
C19778	9	C19655	18		

\$1.50
Each

Additional Howard W. Sams sets will be available as soon as they come off the press as indicated below:

October 15—Set No. 26, 27

November 15—Set No. 28, 29

December 15—Set No. 30.

Other sets may be ordered as announced in trade publications.

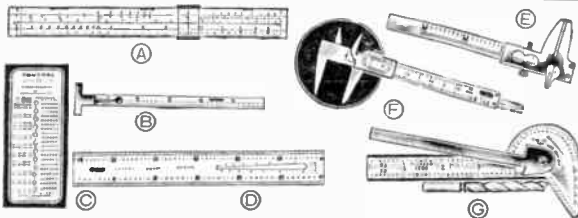

DIETZGEN Slide Rules

Ⓐ 10" National Slide Rule (Maniphase Type) Graduations on high quality white surface, with moulded one-piece unbreakable indicator. Reverse side of rule has inch scale on one edge and millimeter on other edge. Back of rule has special conversion tables and decimal equivalent chart. With imitation leather case and instructions. **\$1.35**
C14889 Each

Handy Steel Rule and Depth Gauge

Ⓑ A handy, accurate pocket rule for quick measurement. Made of steel, with pocket clip for depth measurements. 6 inches long, graduated in quick reading 6ths. **10¢**
C14996 Your Cost, Each

Drill and Wire Gauge

Ⓒ Highly accurate — of hardened and tempered steel. Clear, easy-to-read numerals. Drill, tap size and decimal equivalents of each. Pocket size. **95¢**
C14997— Each

Steel 6" Rule with B&S Wire Gauge

Ⓓ Front graduated in quick reading 32nds and 64ths; also has American or B&S wire gauge for sizes from No. 8 to No. 20. B&S wire gauge decimal equivalents. **25¢**
C15007— Each
Without wire gauge. $\frac{3}{4}$ " wide. **24¢**
C14982— Each

Slide Caliper Rule

Ⓔ Inside and outside diameters up to 3 inches. Knurled lock nut. Wt. 8 oz. **12¢**
C14891— Your Cost

Vernier Sliding Caliper

Ⓕ Precision made of fine tool steel .5" rule graduated in 16ths and 32nds. 5" depth gauge. Vernier caliper has lock nut. Sharp pointed projections for accurate dividing, scribing. Wt. 1 lb. **98¢**
C15027— Each

Multi-Use Rule & Gauge

Ⓖ Four inch quick-reading 32nd and 64th inch scale, drill point gauge, square, bevel protractor, center finder, circle divider, tap drill table. **95¢**
C14998— Your Cost

Howard W. Sams FOLDERS RULES·GAUGES·VIBRO-TOOLS

- ★ Fast—Efficient—No need to wait for sorely needed facts
- ★ Inexpensive—Costs only 3c to 5c for each folder
- ★ 30 radio specialists for practical radio service answers

"PHOTOFACTS" Volume 2



Folder sets No. 11 through 20 in a first class hard cover binder that lies perfectly flat regardless of where opened or how full. Brings together all your PhotoFact folders within one binder, yet assures quick location of any desired set. Any sheet removed or added any time—any place. Expands from 2 1/4 to 4 1/4 in. as sheets are added. Holds up to 500 four-page folders without bulging. Easy addition or removal of any individual sheet.

C20356—Your Cost Postpaid. **\$18.39**

Volume 1. . . . Same as above but with Folder

Sets No. 1 through 10.

C19781—Your Cost Postpaid. **\$18.39**

PHOTOFACT Binder Only

For those who already have sets previous to No. 10, those who have partial sets. Identically the same binder, but does not include PhotoFact Folders.

C19785—Your Cost. **\$3.39**

Dial Cord Stringing Guide

Only book of its kind. Licks the knottiest dial cord problem in a matter of minutes. You will need two or more—one for the tool kit and one for the work bench. Handy pocket size, yet over 96 pages of detailed information on the correct stringing of all dials after 1938. **75¢**
C19658— Your Cost

Automatic Record Changer Manual

Exclusive exploded views of top, side, bottom, rears. Tells models in which used. Complete change cycle data. Full information on adjustments. All service kinks and hints. Parts lists keyed to diagrams. Includes wire, paper and disc recorders. Covers more than 40 different post war models. 116 pages. Hard cover, Smyth sewed. Lies absolutely flat on the bench. **\$4.95**
C19659— Your Cost

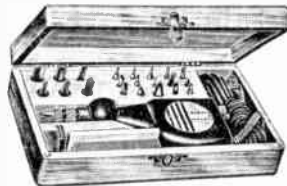

BURGESS Vibro-tool Kit

Kit includes one Vibro-tool which operates by vibration—delivering 120 strokes per second. Used to file, chisel, hammer or groove soft metals, for cutting wood, cardboard and textile patterns, and for marking lines on or drilling glass. Kit also includes 1 standard engraving needle, 1 tantalum carbide needle, 1 curved and 1 straight edged knife, and foot gauge. 6 wood chisels, 1 abrasive point, six leather working tools, and five ball points. All housed in sturdy hinged wood case with natural polished finish. **\$9.90**
C15625—Your Cost

C15625—Your Cost

Vibro-tool only with standard engraving needle. **\$4.50**
C15620—Your Cost

Carving chisels for wood linoleum, six to package. **90¢**
C15632—Your Cost

Abrasive point for frosting glass, smoothing other surfaces. **45¢**
C15634—Your Cost

Foot gauge for knife at attachments to regulate depth of cut. **57¢**
C15636—Your Cost

Diamond point for continuous glass work, line engraving on jewelry. **\$3.58**
C15633—Your Cost

Set of 6 leather tools, slotter, 1/8" punch, liner, deerfoot, spoon, and combination double liner, cupper. **90¢**
C15635—Your Cost

Color Graving kit, six assorted wax color sticks. **96¢**
C15637—Your Cost

Knife Attachments for cutting into thin wood, cardboard, etc. **30¢**
C15626—Straight knife, cuts up to 1/2" thickness. Pkg. of 3.

30¢
C15627—Curved knife, cuts up to 3/8" thickness. Pkg. of 3.

30¢
Pkg. of 5 blunt hammering tips for leather or thin metals.

57¢
C15628—Your Cost

Extra Needles. Standard needle for metal, plastics or any soft to medium hard materials. **9¢**
C15629—Your Cost

Tungsten Point for hardened tool steel, and continuous work on all metals. **\$1.20**
C15630—Your Cost

HAND TOOLS

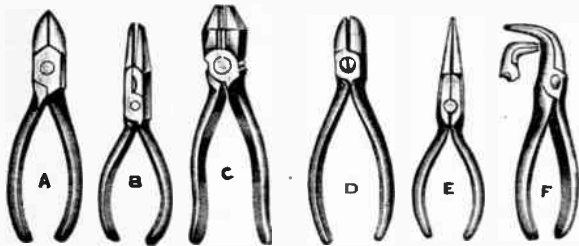

KRAEUTER Pliers

These tools are from Krauter's "Standard" series. Do not confuse with the lower priced "K" series. Drop forged from extra high grade steel. Have the famous "blue temper" finish. Stand up under severe service.

A—Diagonal Cutting Pliers		
No.	Length	Your Cost
C14942	4 1/2"	\$1.45
C14944	6"	1.87

Wire Stripping Diagonal Cutter. Similar to A except has notch in blades to strip .062 wire and has spring in handle to close jaws. For fast work.

No.	Length	Your Cost
C14947	6 1/2"	\$2.34

B—Long Nose Pliers

Short-jaw and long-jaw needle-nose pliers with side-cutting blades.

No.	Length	Your Cost
C14946	5" short jaw	\$1.70
C14945	6" long jaw	1.79

C—Electrician's Cutter

Modified electrician's pliers with fitted lap joint and cutters.

No.	Length	Your Cost
C14935	6 1/2"	\$1.62
C14936	8"	2.08

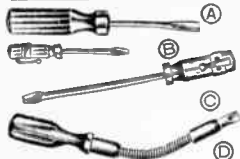

Neon-Light Screw Drivers

Quality screw drivers with neon lamp built into amber Pyroxylin handle. For R.F.
C15348—1 1/4" long. Each... 29c
C15349—7" long. Each... 25c

VACO "Amberly" Pocket Screwdrivers

Transparent amber colored plastic handles. Tool steel blades; shockproof construction. 3" long with pocket clip.
C15323—Each **15¢**

VACO "Amberly" Radio Screwdrivers

Transparent amber colored plastic handles. Oil tempered tool steel blades. Rust-proof, unbreakable, shock-proof. Blade diameter small enough for radio set screws.

Stock No.	Blade	Each
C15324	1/4"x4"	35c
C15325	1/4"x6"	35c
C15326	1/4"x8"	39c

ICAFlexibleScrewdriver

Strong, unbreakable, flexible shaft and insulated movable screw locator finds slots of screws, 8 3/4".
C15062—Your Cost **\$1.18**

Genuine KLEIN Pliers

Finest alloy tool steel. Individually tempered to assure long-life cutting edges.

C15223—(D) Oblique Cutting Pliers with Wire Stripping Notch. Lap joint; narrow head. 5" long. Shpg. wt. 3 lbs.
Your Cost... **\$2.70**

C15221—(E) Long Nose Side Cutting Pliers. Pointed slender nose—sharp cutters. 6" long.

C15224—(F) Long Curved Nose Pliers. Very useful in close quarters. 6" long.

Either Above Type... **\$2.75**
Your Cost, Each...

"RHINO" Screwdrivers with Amberlite Handles



Finest screwdrivers, for electrical use. Special analysis steel blade over half-way into Shock-proof Amberlite handle.

C15345	—3x1 1/8" blade.	Each... 41c
C15346	—6x1 1/8" blade.	Each... 54c
C15347	—8x1 1/8" blade.	Each... 62c

"Grip" Screwdrivers

Gripper holds screw and slides up out of the way when not in use. Instant release after screw is driven. Fine for tight places. Tempered steel blades. Amber plastic insulated handles.

No.	Blades	Each
C14710	2x3 1/4"	26c
C14721	4x3 1/2"	46c
C14722	10x3 1/2"	52c

Phillips Offset Screwdriver

A very handy alloy steel offset screwdriver. One end for Phillips No. 1 size; other end for Phillips No. 2 size.
C15255—Each **35¢**

Phillips Recessed Head Screwdrivers

Many sets now use the type of screw requiring this new model driver. Sturdy sure-grip wood handles. Shpg. wt. 1 lb.

Stock No.	Size No.	Length Ins.	Your Cost
C15251	up to 4	6 3/4"	25c
C15252	5 to 9	8 3/4"	25c
C15253	10 to 16	11 1/2"	33c

STEVENS WALDEN "SPINTITES"

Chuck Type Spintite Kit

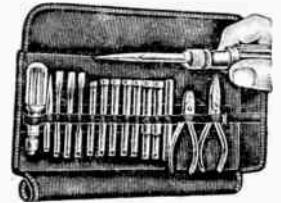
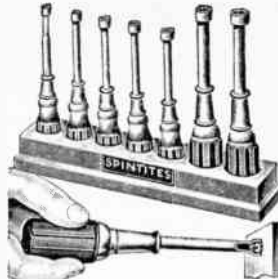

The original Spintite. A handy wrench that works like a screw-driver. Indispensable for radio and electrical servicemen and small parts manufacturers. Made of selected steel, cadmium plated with hardwood handle.

Stock No.	Part No.	Size Hex Nut	Lgt.
C15556	3406	3/8"	6"
C15562	3407	1/2"	6"
C15563	3408	3/4"	6"
C15564	3409	7/8"	6"
C15557	3410	1"	6"
C15558	3411	1 1/8"	6"
C15559	3412	1 1/4"	6"

Any Type Above Your Cost Each... **38¢**

C15560	3414	1 1/2"	7 1/8"
C15561	3416	1 3/4"	7 3/8"

Any Type Above Your Cost Each... **53¢**

Deluxe kit consisting of chuck type handle adaptable for use with the wrench shanks, screw drivers and reamer. Includes 3/8", 1/2", 3/4", 7/8", 1", 1 1/8", 1 1/4", 1 1/2", 1 3/4", 1 7/8", 2", 2 1/8", 2 1/4", 2 1/2", 2 3/4", 3", 3 1/4", 3 1/2", 3 3/4", 4", 4 1/4", 4 1/2", 4 3/4", 5", 5 1/4", 5 1/2", 5 3/4", 6", 6 1/4", 6 1/2", 6 3/4", 7", 7 1/4", 7 1/2", 7 3/4", 8", 8 1/4", 8 1/2", 8 3/4", 9", 9 1/4", 9 1/2", 9 3/4", 10", 10 1/4", 10 1/2", 10 3/4", 11", 11 1/4", 11 1/2", 11 3/4", 12", 12 1/4", 12 1/2", 12 3/4", 13", 13 1/4", 13 1/2", 13 3/4", 14", 14 1/4", 14 1/2", 14 3/4", 15", 15 1/4", 15 1/2", 15 3/4", 16", 16 1/4", 16 1/2", 16 3/4", 17", 17 1/4", 17 1/2", 17 3/4", 18", 18 1/4", 18 1/2", 18 3/4", 19", 19 1/4", 19 1/2", 19 3/4", 20", 20 1/4", 20 1/2", 20 3/4", 21", 21 1/4", 21 1/2", 21 3/4", 22", 22 1/4", 22 1/2", 22 3/4", 23", 23 1/4", 23 1/2", 23 3/4", 24", 24 1/4", 24 1/2", 24 3/4", 25", 25 1/4", 25 1/2", 25 3/4", 26", 26 1/4", 26 1/2", 26 3/4", 27", 27 1/4", 27 1/2", 27 3/4", 28", 28 1/4", 28 1/2", 28 3/4", 29", 29 1/4", 29 1/2", 29 3/4", 30", 30 1/4", 30 1/2", 30 3/4", 31", 31 1/4", 31 1/2", 31 3/4", 32", 32 1/4", 32 1/2", 32 3/4", 33", 33 1/4", 33 1/2", 33 3/4", 34", 34 1/4", 34 1/2", 34 3/4", 35", 35 1/4", 35 1/2", 35 3/4", 36", 36 1/4", 36 1/2", 36 3/4", 37", 37 1/4", 37 1/2", 37 3/4", 38", 38 1/4", 38 1/2", 38 3/4", 39", 39 1/4", 39 1/2", 39 3/4", 40", 40 1/4", 40 1/2", 40 3/4", 41", 41 1/4", 41 1/2", 41 3/4", 42", 42 1/4", 42 1/2", 42 3/4", 43", 43 1/4", 43 1/2", 43 3/4", 44", 44 1/4", 44 1/2", 44 3/4", 45", 45 1/4", 45 1/2", 45 3/4", 46", 46 1/4", 46 1/2", 46 3/4", 47", 47 1/4", 47 1/2", 47 3/4", 48", 48 1/4", 48 1/2", 48 3/4", 49", 49 1/4", 49 1/2", 49 3/4", 50", 50 1/4", 50 1/2", 50 3/4, 51", 51 1/4", 51 1/2", 51 3/4, 52", 52 1/4", 52 1/2", 52 3/4, 53", 53 1/4", 53 1/2", 53 3/4, 54", 54 1/4", 54 1/2", 54 3/4, 55", 55 1/4", 55 1/2", 55 3/4, 56", 56 1/4", 56 1/2", 56 3/4, 57", 57 1/4", 57 1/2", 57 3/4, 58", 58 1/4", 58 1/2", 58 3/4, 59", 59 1/4", 59 1/2", 59 3/4, 60", 60 1/4", 60 1/2", 60 3/4, 61", 61 1/4", 61 1/2", 61 3/4, 62", 62 1/4", 62 1/2", 62 3/4, 63", 63 1/4", 63 1/2", 63 3/4, 64", 64 1/4", 64 1/2", 64 3/4, 65", 65 1/4", 65 1/2", 65 3/4, 66", 66 1/4", 66 1/2", 66 3/4, 67", 67 1/4", 67 1/2", 67 3/4, 68", 68 1/4", 68 1/2", 68 3/4, 69", 69 1/4", 69 1/2", 69 3/4, 70", 70 1/4", 70 1/2", 70 3/4, 71", 71 1/4", 71 1/2", 71 3/4, 72", 72 1/4", 72 1/2", 72 3/4, 73", 73 1/4", 73 1/2", 73 3/4, 74", 74 1/4", 74 1/2", 74 3/4, 75", 75 1/4", 75 1/2", 75 3/4, 76", 76 1/4", 76 1/2", 76 3/4, 77", 77 1/4", 77 1/2", 77 3/4, 78", 78 1/4", 78 1/2", 78 3/4, 79", 79 1/4", 79 1/2", 79 3/4, 80", 80 1/4", 80 1/2", 80 3/4, 81", 81 1/4", 81 1/2", 81 3/4, 82", 82 1/4", 82 1/2", 82 3/4, 83", 83 1/4", 83 1/2", 83 3/4, 84", 84 1/4", 84 1/2", 84 3/4, 85", 85 1/4", 85 1/2", 85 3/4, 86", 86 1/4", 86 1/2", 86 3/4, 87", 87 1/4", 87 1/2", 87 3/4, 88", 88 1/4", 88 1/2", 88 3/4, 89", 89 1/4", 89 1/2", 89 3/4, 90", 90 1/4", 90 1/2", 90 3/4, 91", 91 1/4", 91 1/2", 91 3/4, 92", 92 1/4", 92 1/2", 92 3/4, 93", 93 1/4", 93 1/2", 93 3/4, 94", 94 1/4", 94 1/2", 94 3/4, 95", 95 1/4", 95 1/2", 95 3/4, 96", 96 1/4", 96 1/2", 96 3/4, 97", 97 1/4", 97 1/2", 97 3/4, 98", 98 1/4", 98 1/2", 98 3/4, 99", 99 1/4", 99 1/2", 99 3/4, 100", 100 1/4", 100 1/2", 100 3/4, 101", 101 1/4", 101 1/2", 101 3/4, 102", 102 1/4", 102 1/2", 102 3/4, 103", 103 1/4", 103 1/2", 103 3/4, 104", 104 1/4", 104 1/2", 104 3/4, 105", 105 1/4", 105 1/2", 105 3/4, 106", 106 1/4", 106 1/2", 106 3/4, 107", 107 1/4", 107 1/2", 107 3/4, 108", 108 1/4", 108 1/2", 108 3/4, 109", 109 1/4", 109 1/2", 109 3/4, 110", 110 1/4", 110 1/2", 110 3/4, 111", 111 1/4", 111 1/2", 111 3/4, 112", 112 1/4", 112 1/2", 112 3/4, 113", 113 1/4", 113 1/2", 113 3/4, 114", 114 1/4", 114 1/2", 114 3/4, 115", 115 1/4", 115 1/2", 115 3/4, 116", 116 1/4", 116 1/2", 116 3/4, 117", 117 1/4", 117 1/2", 117 3/4, 118", 118 1/4", 118 1/2", 118 3/4, 119", 119 1/4", 119 1/2", 119 3/4, 120", 120 1/4", 120 1/2", 120 3/4, 121", 121 1/4", 121 1/2", 121 3/4, 122", 122 1/4", 122 1/2", 122 3/4, 123", 123 1/4", 123 1/2", 123 3/4, 124", 124 1/4", 124 1/2", 124 3/4, 125", 125 1/4", 125 1/2", 125 3/4, 126", 126 1/4", 126 1/2", 126 3/4, 127", 127 1/4", 127 1/2", 127 3/4, 128", 128 1/4", 128 1/2", 128 3/4, 129", 129 1/4", 129 1/2", 129 3/4, 130", 130 1/4", 130 1/2", 130 3/4, 131", 131 1/4", 131 1/2", 131 3/4, 132", 132 1/4", 132 1/2", 132 3/4, 133", 133 1/4", 133 1/2", 133 3/4, 134", 134 1/4", 134 1/2", 134 3/4, 135", 135 1/4", 135 1/2", 135 3/4, 136", 136 1/4", 136 1/2", 136 3/4, 137", 137 1/4", 137 1/2", 137 3/4, 138", 138 1/4", 138 1/2", 138 3/4, 139", 139 1/4", 139 1/2", 139 3/4, 140", 140 1/4", 140 1/2", 140 3/4, 141", 141 1/4", 141 1/2", 141 3/4, 142", 142 1/4", 142 1/2", 142 3/4, 143", 143 1/4", 143 1/2", 143 3/4, 144", 144 1/4", 144 1/2", 144 3/4, 145", 145 1/4", 145 1/2", 145 3/4, 146", 146 1/4", 146 1/2", 146 3/4, 147", 147 1/4", 147 1/2", 147 3/4, 148", 148 1/4", 148 1/2", 148 3/4, 149", 149 1/4", 149 1/2", 149 3/4, 150", 150 1/4", 150 1/2", 150 3/4, 151", 151 1/4", 151 1/2", 151 3/4, 152", 152 1/4", 152 1/2", 152 3/4, 153", 153 1/4", 153 1/2", 153 3/4, 154", 154 1/4", 154 1/2", 154 3/4, 155", 155 1/4", 155 1/2", 155 3/4, 156", 156 1/4", 156 1/2", 156 3/4, 157", 157 1/4", 157 1/2", 157 3/4, 158", 158 1/4", 158 1/2", 158 3/4, 159", 159 1/4", 159 1/2", 159 3/4, 160", 160 1/4", 160 1/2", 160 3/4, 161", 161 1/4", 161 1/2", 161 3/4, 162", 162 1/4", 162 1/2", 162 3/4, 163", 163 1/4", 163 1/2", 163 3/4, 164", 164 1/4", 164 1/2", 164 3/4, 165", 165 1/4", 165 1/2", 165 3/4, 166", 166 1/4", 166 1/2", 166 3/4, 167", 167 1/4", 167 1/2", 167 3/4, 168", 168 1/4", 168 1/2", 168 3/4, 169", 169 1/4", 169 1/2", 169 3/4, 170", 170 1/4", 170 1/2", 170 3/4, 171", 171 1/4", 171 1/2", 171 3/4, 172", 172 1/4", 172 1/2", 172 3/4, 173", 173 1/4", 173 1/2", 173 3/4, 174", 174 1/4", 174 1/2", 174 3/4, 175", 175 1/4", 175 1/2", 175 3/4, 176", 176 1/4", 176 1/2", 176 3/4, 177", 177 1/4", 177 1/2", 177 3/4, 178", 178 1/4", 178 1/2", 178 3/4, 179", 179 1/4", 179 1/2", 179 3/4, 180", 180 1/4", 180 1/2", 180 3/4, 181", 181 1/4", 181 1/2", 181 3/4, 182", 182 1/4", 182 1/2", 182 3/4, 183", 183 1/4", 183 1/2", 183 3/4, 184", 184 1/4", 184 1/2", 184 3/4, 185", 185 1/4", 185 1/2", 185 3/4, 186", 186 1/4", 186 1/2", 186 3/4, 187", 187 1/4", 187 1/2", 187 3/4, 188", 188 1/4", 188 1/2", 188 3/4, 189", 189 1/4", 189 1/2", 189 3/4, 190", 190 1/4", 190 1/2", 190 3/4, 191", 191 1/4", 191 1/2", 191 3/4, 192", 192 1/4", 192 1/2", 192 3/4, 193", 193 1/4", 193 1/2", 193 3/4, 194", 194 1/4", 194 1/2", 194 3/4, 195", 195 1/4", 195 1/2", 195 3/4, 196", 196 1/4", 196 1/2", 196 3/4, 197", 197 1/4", 197 1/2", 197 3/4, 198", 198 1/4", 198 1/2", 198 3/4, 199", 199 1/4", 199 1/2", 199 3/4, 200", 200 1/4", 200 1/2", 200 3/4, 201", 201 1/4", 201 1/2", 201 3/4, 202", 202 1/4", 202 1/2", 202 3/4, 203", 203 1/4", 203 1/2", 203 3/4, 204", 204 1/4", 204 1/2", 204 3/4, 205", 205 1/4", 205 1/2", 205 3/4, 206", 206 1/4", 206 1/2", 206 3/4, 207", 207 1/4", 207 1/2", 207 3/4, 208", 208 1/4", 208 1/2", 208 3/4, 209", 209 1/4", 209 1/2", 209 3/4, 210", 210 1/4", 210 1/2", 210 3/4, 211", 211 1/4", 211 1/2", 211 3/4, 212", 212 1/4", 212 1/2", 212 3/4, 213", 213 1/4", 213 1/2", 213 3/4, 214", 214 1/4", 214 1/2", 214 3/4, 215", 215 1/4", 215 1/2", 215 3/4, 216", 216 1/4", 216 1/2", 216 3/4, 217", 217 1/4", 217 1/2", 217 3/4, 218", 218 1/4", 218 1/2", 218 3/4, 219", 219 1/4", 219 1/2", 219 3/4, 220", 220 1/4", 220 1/2", 220 3/4, 221", 221 1/4", 221 1/2", 221 3/4, 222", 222 1/4", 222 1/2", 222 3/4, 223", 223 1/4", 223 1/2", 223 3/4, 224", 224 1/4", 224 1/2", 224 3/4, 225", 225 1/4", 225 1/2", 225 3/4, 226", 226 1/4", 226 1/2", 226 3/4, 227", 227 1/4", 227 1/2", 227 3/4, 228", 228 1/4", 228 1/2", 228 3/4, 229", 229 1/4", 229 1/2", 229 3/4, 230", 230 1/4", 230 1/2", 230 3/4, 231", 231 1/4", 231 1/2", 231 3/4, 232", 232 1/4", 232 1/2", 232 3/4, 233", 233 1/4", 233 1/2", 233 3/4, 234", 234 1/4", 234 1/2", 234 3/4, 235", 235 1/4", 235 1/2", 235 3/4, 236", 236 1/4", 236 1/2", 236 3/4, 237", 237 1/4", 237 1/2", 237 3/4, 238", 238 1/4", 238 1/2", 238 3/4, 239", 239 1/4", 239 1/2", 239 3/4, 240", 240 1/4", 240 1/2", 240 3/4, 241", 241 1/4", 241 1/2", 241 3/4, 242", 242 1/4", 242 1/2", 242 3/4, 243", 243 1/4", 243 1/2", 243 3/4, 244", 244 1/4", 244 1/2", 244 3/4, 245", 245 1/4", 245 1/2", 245 3/4, 246", 246 1/4", 246 1/2", 246 3/4, 247", 247 1/4", 247 1/2", 247 3/4, 248", 248 1/4", 248 1/2", 248 3/4, 249", 249 1/4", 249 1/2", 249 3/4, 250", 250 1/4", 250 1/2", 250 3/4, 251", 251 1/4", 251 1/2", 251 3/4, 252", 252 1/4", 252 1/2", 252 3/4, 253", 253 1/4", 253 1/2", 253 3/4, 254", 254 1/4", 254 1/2", 254 3/4, 255", 255 1/4", 255 1/2", 255 3/4, 256", 256 1/4", 256 1/2", 256 3/4, 257", 257 1/4", 257 1/2", 257 3/4, 258", 258 1/4", 258 1/2", 258 3/4, 259", 259 1/4", 259 1/2", 259 3/4, 260", 260 1/4", 260 1/2", 260 3/4, 261", 261 1/4", 261 1/2", 261 3/4, 262", 262 1/4", 262 1/2", 262 3/4,

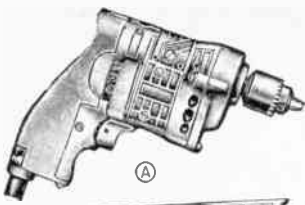

THOR 1/4" Capacity Electric Drills

(A) Standard Duty. 3 conductor line cord with ground wire and plug for use on 115 volt line either AC or DC. Free speed approximately 1900-2000 RPM. Wt. 3 lbs. Overall length 7 3/4". Ball bearings throughout. Uses 2-pole trigger switch. For continuous or intermittent duty.

C15799—Your Cost..... \$35.50



(B) "DRILL Champion." Light duty. Weight 4 lbs. Overall length 11 3/4". Oilite self-lubricating bearings and special alloy steel gears. Extremely efficient motor. Recessed thumb-control switch. For light duty intermittent service.

C15798—Your Cost..... \$25.00

Portable Electric Drill Set

(C) Complete "on the job drill shop" portable electric drill set consisting of 1/4" capacity electric drill, 13 high speed mechanic's size drills 1/16" to 1/2" by 64ths, and sturdy steel box. Portable drill and drills always together! Drills are set in indexing removable holder that can be set on bench. Gear drive type universal motor with oilite bronze bearings mounted in die cast aluminum alloy housing. Pistol grip handle and 6' power cord. 115 volts AC DC.

C15769—Your Cost..... \$24.95

DeLux Handee Grinder

(D) Will drill, grind, polish, cut, carve, saw and engrave all materials. Fits the hand, yet has powerful high-speed motor (25,000 RPM). Ball bearing construction, packed in lubrication, enclosed motor, built-in switch. Operates on 110-120 volts 20-60 cycles AC or DC. Supplied with 1/8" spring collet chuck.

DeLux Handee outfit, with 27 accessories in steel carrying case. Accessories include: rubber polishing wheel with mandrel; saw with mandrel, slitting saw; two steel cutters; three drills; push-pin mandrel; steel wire cavity brush; bristle brush; wire scratch brush; rubber disc with mandrel, felt polishing point with mandrel; rubber polishing point with mandrel; felt polishing wheel; drum sander and three bands; disc cleaning brush; mounted wheels (six); wheel dressing stone; vial of speed oil; dozen assorted sandpaper discs. Shpg. wt. 8 lbs.

C15263—No. 3010. Your Cost..... \$23.37

C15264—No. 3011. Same as the above, but with 26 assorted Mounted Wheels for industrial application. Each..... \$23.37

C15354—De Luxe HANDEE complete with 7 accessories as follows: 1/2" Collet; 5 Wheels; 1 Rubber Polishing Wheel; 1 Wheel Dressing Stone. Speed 25,000 r.p.m. No. 3008B Each..... \$17.42

WALSCO Staple Driver

(E) For neater, faster jobs on all wire and cable installations. Lightweight, rustproof construction. Staples wires up to 1/4" diam. Fully automatic. Magazine holds 24 staples. Wt. 2 lbs.

C15091—Staple-Driver, with one box of 250 staples. Your Cost..... \$4.85

Rubber Cap

(F) Covers plunger head and makes it easier on the hand.

C15090—Each..... 22c

WALSCO Steel Staples

(A) Made of carbon tool steel. In strips especially made for the WalSCO Staple Driver. Inside coated with special clear insulating lacquer. Brown color.

C15093—Box 250..... 32¢
C15099—Box 1000..... \$1.24
C15100—Box 5000..... \$2.90

Featherweight Tacker and Stapling Machine

(B) A quick, handy tacker that is exceptionally convenient for tacking on grille cloth, attaching light wire or spaghetti, labels, etc. In addition to its use as a tacker it can also be used as a regular office or home stapling machine for clipping papers, receipts, checks, etc. Precision built, of steel with fine black finish. With 100 staples.

C15280—Your Cost..... \$1.60

C15281—Box of 1000 Staples .35c PER 10,000..... \$2.90

Wood Chisels

(C) Genuine Amberlite handled, beveled wood chisels. High grade steel blades, heat treated and oil tempered. Correctly proportioned bevels—tested to cut rock maple.

No.	Blade	Each
C15513	1 1/2"	45c
C15514	2"	45c
C15515	1 3/4"	52c
C15516	1 1/2"	56c

Handy Chisel Kit

Consists of one each of the above chisels, in a strong canvas roll. Buy the complete set at this special low price!

C15517—Your Cost..... \$2.10

CAN'T ROLL Center Punch

(D) Tempered steel with large head and knurled grip. Square head will not roll. Length 1 1/2", diameter .325". Shpg. wt. 1 lb.

C14999—Your Cost..... 12¢



CENTURY High Speed DRILL SETS

CENTURY high speed drills are highest quality, high precision tools. Made from finest tungsten-molybdenum tool steel. These drills have the stamina to withstand the punishment that dulls or burns carbon steel drills. They will withstand operating temperatures up to 1200°. The mechanic's length is slightly shorter than the toolmaker's drill, thus lessening whip and breakage. The all-steel Huot Index opens up like the pages of a book, stands on the bench with every drill accessible and identified as to size. When closed the drills are safe from harm.

Set No. M-7

Seven Century high speed drills 1/16" to 1/4" by 32nds with a sturdy red bakelite stand. Stand serves as an index, each hole is marked to indicate size of drill that fits into it.

C15760—Your Cost..... \$2.43

Set No. M-3

Thirteen Century high speed drills 1/16" to 1/2" by 64ths with Huot index. Smallest of the Huot drill indexes, yet contains the most often used drill sizes. Ideal to have in the tool kit.

C15761—Your Cost..... \$4.61

Set No. M-2

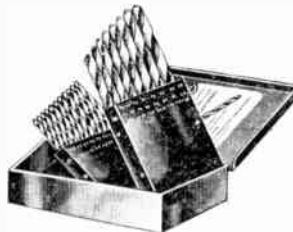

Twenty one Century high speed drills 1/16" to 3/8" by 64ths with Huot index. Medium size Huot index, with the extended drill size range, adding those often needed drill sizes.

C15762—Each..... \$11.17

Set No. M-15



Fifteen Century high speed drills 1/16" to 1/2" by 32nds with Huot index. Large size Huot, with provisions for adding 14 drills of the 64th sizes. Has the larger size drills often needed.

C15763—Each..... \$12.75

INDIVIDUAL DRILLS

Stock No.	Size	Each	Stock No.	Size	Each
C15770	1/16"	18c	C15780	1/2"	36c
C15771	3/32"	19c	C15781	5/8"	39c
C15772	1/8"	20c	C15782	3/4"	42c
C15773	1/4"	21c	C15783	1 1/8"	47c
C15774	3/8"	22c	C15784	1 1/4"	51c
C15775	1/2"	24c	C15785	1 3/8"	56c
C15776	5/8"	26c	C15786	1 1/2"	61c
C15777	1 1/8"	28c	C15787	1 3/4"	67c
C15778	1 1/4"	30c	C15788	1 7/8"	73c
C15779	1 3/8"	32c	C15789	2"	85c

ACRO Chassis and Changer Cradle

(E) Steel framework and cork-padded clamps to hold chassis or phonochanger at any angle. Keeps your work off the table. Work in the bottom of chassis without endangering tubes. Stands on table or workbench. Tilt chassis vertically to work while sitting, or horizontally if you prefer to stand. Adjustable for any size of chassis or changer. Groove in each clamp accommodates flanged in bottom edges of chassis. Complete with standard clamps for grasping vertical surfaces of chassis or changer.

C15085—Your Cost..... \$4.85

Straight clamps for holding flat work. Will also enable you to use your cradle as a reel.

C15086—Your Cost Per Pair..... \$2.45

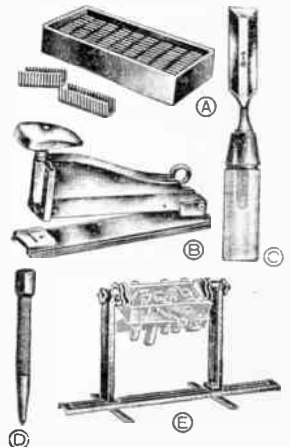

SOLDERING IRONS

DRAKE Industrial Irons Underwriter's Listed

(A) No. 600-10. Suggested for switchboards radio and other light manufacturing uses Ideal for close quarters. Complete with 6' cord and stand. $\frac{3}{8}$ " tip. Shpg. wt. 2 lbs. **\$4.12**
C15164—Your Cost
C15152—Replacement tip for above.....39c

(B) No. 600. Suggested for switchboards, radio and other light manufacturing uses. Complete with 6-ft. cord and "Magic Cup" stand. Shpg. wt. 2 lbs. $\frac{3}{8}$ " tip. **\$3.82**
C15551—Your Cost
C15152—Replacement tip for above.....39c

(C) No. 800. Recommended for general factory soldering, art glass and medium tin work. 6-ft. cord. Ideal for auto work, lamp wiring, and home repairs. Shpg. wt. 3 lbs.
C15550—Your Cost
C15152—Replacement tip for above.....39c

(D) No. 400. Smallest industrial iron, for tight corner and delicate instrument wiring. Measures 9" and weighs only 9oz. 60 watts with $\frac{1}{4}$ " tip. With 6-ft. cord and Magic Cup stand. Underwriter's Approved. Wt. 1 lb. **\$2.91**
C14835—Your Cost
C15157—Replacement tip for above.....32c

(E) Replacement plunger type tips of quality copper.

No.	Iron	Size	Each
C15167	25-40 w.	$\frac{1}{4} \times 2\frac{1}{2}$ "	25c
C15166	60-75 w.	$\frac{3}{8} \times 2\frac{1}{2}$ "	27c
C14903	85-100 w.	$\frac{3}{8} \times 4\frac{1}{2}$ "	21c
C15168	115-150 w.	$1\frac{1}{2} \times 3\frac{1}{2}$ "	32c

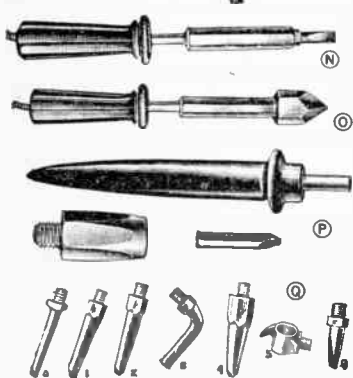
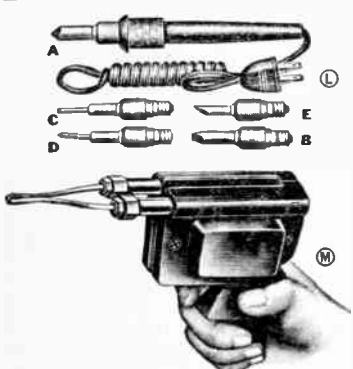

DRAKE DeLuxe Irons 100 Watt

(F) No. 325. For general radio work. High quality Nichrome wire wound on amber mica. With 6 ft. cord, plug and "Magic Cup" Stand. Nickel plated. $\frac{3}{8}$ " tip. Shpg. wt. 1 $\frac{1}{2}$ lbs. **\$2.76**
C15162—Your Cost
C15152—Replacement tip for above.....39c

(G) No. 326. Extra hot. High quality Nichrome wire wound on amber mica. With $\frac{3}{8}$ " tip, 6-ft. cord, rubber plug, and stand. **\$3.23**
C15163—Your Cost
C15152—Replacement tip for above.....39c

(H) No. 425. For all medium heavy work. Highest quality Nichrome wire wound on amber mica. Ideal for auto work, lamp wiring, home repairs, etc. 6-ft. cord and stand. Nickel plated. $\frac{3}{8}$ " tip. Wt. 2 lbs. **\$5.29**
C15552—Your Cost
C15153—Replacement tip for above.....63c

(J) Sturdily constructed. Resistance wire elements wound on porcelain tubes, with 6-ft. cord and plug. **\$1.00**
C14892—60-Watt Iron.....39c
C15158—Replacement tip for above.....39c
C14893—100-Watt Iron.....\$1.73
C15159—Replacement tip for above.....59c

(K) A high-quality continuous-duty 35W iron only 6 $\frac{1}{2}$ " long. Element wound on mica-insulated steel core same as industrial irons. Complete with straight $\frac{1}{8}$ " tip, bent $\frac{1}{8}$ " tip, and stand. U. L. approved. **\$2.06**
C15177—Your Cost
C15178—Replacement Straight Tip.....8c
C15179—Replacement 45° Tip.....8c

DRAKE Model 350 Midget

UNGAR Electric Soldering Pencil

(L) An unusually small lightweight iron that can be handled with the ease of a pencil. The total weight is only 3.6 ounces, yet it is a well constructed and efficient soldering iron. Can be used in those hard-to-reach places for everything from the most delicate jobs to some of the larger soldering tasks. Draws 20 watts. Its overall length is only 7 inches. Handle is of sturdy heat resistant plastic. Heats in 90 seconds. Underwriters Listed. For 110 volt AC-10C. With line cord and plug. Uses any of the five special tips listed below.
C15575—Soldering Pencil, less tip
C15576—(A) Standard Copper, tip only
C15577—(B) Elkalo A, Extra Hot, tip only
C15578—(C) Elkalo A, C, chisel, tip only
C15579—(D) Elkalo D, Pencil, tip only
C15580—(E) Brass Marking, tip only
Your Cost.....78c
Any Above.....78c

SPEED IRON

★ Heats and Cools in 5 Seconds
 ★ Gets into Tight Corners
 ★ Easy to Hold
 ★ Easy to Tin

(M) This iron is the first really new idea in soldering tools. Operating on the resistance welder principle giving a high current at a very low voltage. No time is lost waiting for the iron to heat up. No heat is wasted keeping the iron hot—pull the trigger when ready. Working at arm's length is over—the pistol grip gets you in close. No bulky tip to get in the way—you can always see where you are working. Tips stay tinned, can be bent to get into difficult positions, and have a low replacement cost. Impact resisting case houses air-cooled transformer. Modernize your soldering tools now. 100 watts, 115 volts, 60 cycles.
C15183—Your Cost.....\$12.69
C15182—Extra tip, your cost.....5c
C15181—Extra long-life tip, your cost.....10c

KWIKHEAT Soldering Irons 225 Watt

(N) Hot in 90 seconds. Built-in thermostat. Long life Cool handle 13 $\frac{1}{2}$ oz. with No. 9 tip. For use with tips 0, 1, 2, 3, 4, 5, 9, and Kordless receptacle U.L. approved. Guaranteed 1 year. With No. 9 tip and stand. 100-125 volts AC. **C15121—Your Cost.....\$7.34**

(O) Same features as the 225W iron described above. 22 oz. with No. 6 tip. For use with tips 0, 1, 2, 3, 1, 5, 6, 9, and Kordless receptacle. Complete with No. 6 tip and resting stand. 100-125 volts AC only. **C15119—Your Cost \$10.87** Lots of 3 ea. **\$9.68**
C15113—Extra No. 6 tip only.....\$1.32
 Lots of 3 ea. **\$1.17**

KOPPERKORE 100 Watt

Companion to Kwikheat. No thermostat. 13 $\frac{1}{2}$ oz. with No. 9 tip. For use with tips 0, 1, 2, 3, 4, 5, 9. U.L. approved. Guaranteed. With No. 9 tip and stand. 100-120 volts AC or DC. **C15120—Your Cost.....\$5.44**
 Lots of 3—Each **\$4.83**

KORDLESS KOPPER Set

(P) A 3-piece accessory for Kwikheat 225W or 450W Irons. Replace tip of iron with Kordless receptacle, and slip the $\frac{1}{4}$ " dia Kordless tip into the receptacle to heat up. **C15160—Your Cost for set.....\$1.88**
 Lots of 3—Each **\$1.67**

Interchangeable KWIKHEAT Tips

(Q) No. 5 is aluminum. Others are forged Tellurium.

Stk. No.	Type	Stk. No.	Type	Stk. No.	Type
C15122	No. 0	C15125	No. 3	C15127	No. 5
C15123	No. 1	C15126	No. 4	C15165	No. 9
C15124	No. 2				

Your Cost—Any of above—Each.....94c
 Lots of 3 Tips—Each **\$1.83**
 Set of 5—(0, 2, 3, 4, 5) **\$4.13**
C15128—Your Cost for set.....\$4.13

SOLDERING IRONS and Accessories

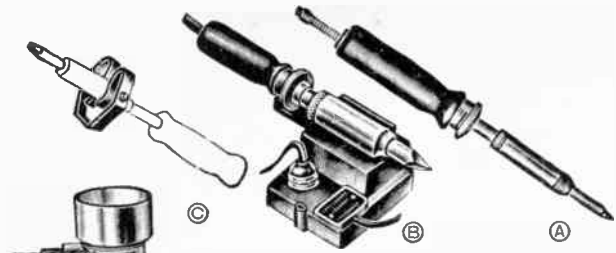

"AMERICAN BEAUTY" Irons

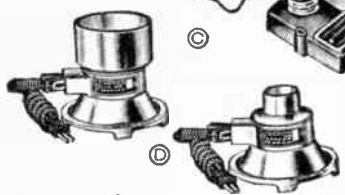

100-Watt, Model 3138
 (A) America's most famous iron. Made for those who want the very best. Metal parts are heavily plated and highly polished. Length 12 7/8". With 3/8" tip and 6-ft. cord. Stand supplied. Shipping weight 2 lbs. **\$5.36**
C15171—Your Cost
C15170—Extra tip for above. Each.....34c

50-Watt, Model S76
 A smaller "American Beauty" for soldering in corners and tight places. 1/8" tip. With stand. Shipping weight 2 lbs. **\$3.34**
C15172—Your Cost
C15173—Extra tip for above. Each.....27c

"AMERICAN BEAUTY" Stand

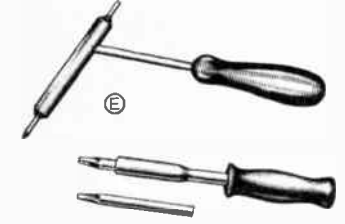

Thermostatic Control
 (B) For regulation of temperature of soldering irons. Thermostat is adjustable. Body of stand of molded plastic, with cord, plug and receptacle to connect iron. For 110 volts A.C. Shpg. wt. 3 lbs. **\$3.88**
C15169—Stand only.
Each.....

Snap-On Iron Holder

(C) Fits all makes and size Irons. Snaps on barrel of iron raises it 2" from bench. Can be left on constantly. Prevents fire damage. **26¢**
C15276—Your Cost.

200- and 325-watt ESICO Solder Pots

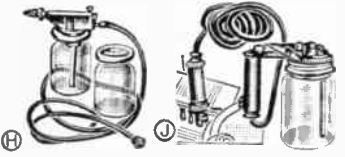

(D) Equipped with pilot light that indicates when pot is heating. Sturdy construction but not top heavy. May be screwed to benches to insure against being knocked over.
 200 watt model. Capacity 3/4 lb. Size 1 1/2"x1 1/2". Overall height 4 1/2". Weight 3 3/4 lbs. **\$4.41**
C15554—Your Cost.
 325 watt model. Capacity 3/4 lbs. Size 3 1/2"x1 1/2". Overall height 4 3/4". Weight 5 1/4 lbs. **\$6.37**
C15555—Your Cost.

KELNOR 125W Soldering Iron

(E) Weighs only 9 oz. Complete with 6-ft. cord, plug, and hard virgin copper pencil tip. Slide tip through barrel to adjust the heat. **\$3.89**
C15111—Your Cost
 Extra virgin-copper tip for replacement: **29¢**
C15112—Your Cost.

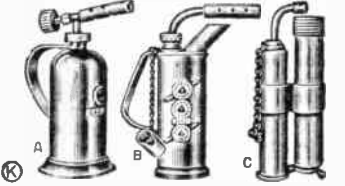

LENK Alcohol and Gasoline Torches

(K) **Type A**—Gasoline torch. Has flame control, shut-off valve, 7 1/2" H.x3" base Diam. Polished Brass. Cap. 1/2 pint. Wt. 2 lbs. **\$1.96**
C14855—Your Cost.
C14856—Same, but for alcohol. Each.....52.12
Type B—Double burner torch—provides either broad or needle point flame. Cleansing pin in handle. 7x4 1/2"x2 1/2". Wt. 3 lbs. **\$2.93**
C14867—Alcohol torch. Each.....
Type C—Compact, leak-proof torch for serviceman and home mechanic. Size: 6x2x1 1/2". **\$1.14**
C14868—Wt. 1 lb. Alcohol torch.
Your Cost, Each.....

New MPC Wire Stripper

(L) Hardened steel blades adjustable for wire size, avoids biting wire off. Strips solid and stranded wire. Insert the wire, twist the tool to cut the insulation sharp and clean, and then pull lightly. The cleanly cut insulation slips off easily. Reaches into hard-to-get-at places, inside cabinets, behind receptacles, etc. Handles up to No. 12 wire. **\$1.14**
C15043—Your Cost.

Motor Chuck Arborg

(M) Fits shaft of any small motor in place of pulley. With flange and locking nut to hold grinding wheels, saws, etc. 1/2" three jaw chuck.

Stock No.	Unit No.	Motor Shaft	Your Cost
C15095	495	1/8"	\$0.75
C15096	490	3/16"	1.05
C15097	490-A	1/4"	.97
C15098	490-B	5/16"	1.13

Geared Chuck for Drills

(N) 5 to 1 geared chuck to use drills up to 1/2" in your small electric drill. Shpg. wt. 4 lbs. **\$7.88**
C14698—Your Cost.

KESTER Solder

(O) Will not spatter. Preferred by servicemen and other large users. Flux in core. The regular rosin and acid core solder is 3/64" diameter. Rosin filled thin-core is approx. 1/16" diameter.

	Resin Core	Acid Core	Rosin Thin-Core
Per Tln	C14857 \$0.17	C14878 \$0.17	C14851 \$0.86
1 lb. Spool	C14858 .83	C14877 .83	C14852 4.10
5 lb. Spool	C14859 3.95	C14879 3.95	

NOKORODE Core Solder

(P) Made of 30% tin and 70% lead. Superior paste used for flux. No. 10 gauge. Approximately 1 1/2 ounces. **8¢**
C14862—Your Cost.

Soldering Paste and Flux

(R) **NOKORODE Paste (top):** Non-corrosive paste. Fluxes all metals except aluminum without corroding or discoloring. Insures perfect soldered joint. Very economical to use. **10¢**
C15277—Per Can, Your Cost.
 (S) **KESTER Paste/Flux (center):** Non-corrosive. For clean, solid connections. In handy two-ounce can. **12¢**
C15278—Your Cost Each.
 (T) **RUBYFLUID LIQUID FLUX.** Produces strong joints with thin film of solder on brass, tin, copper, etc. Non-corrosive. **15¢**
C15279—3 oz. Can Rubyfluid.

ESICO High Quality Soldering Irons

(F) High grade elements are wound on finest mica insulation. Underwriter's approved. Furnished with 6-ft. cord set. For a.c. or d.c. All models are supplied **WITH STAND.** Shipping weight 3 lbs. each.

With Plug-In Tips

Stock No.	Soldering Irons		Your Cost	Extra Tips	
	Watts	Tip Dia.		Stock No.	Your Cost
C14900	60	3/8"	\$1.73	C14901	21c
C14902	100	3/8"	2.32	C14903	21c
C14905	130	1/2"	2.91	C15168	32c

Constant Duty Models

Plug-tip irons especially designed for use in constant duty at factories, labs., etc. For 110 volts a.c. or d.c. Shipping weight 4 lbs.

Soldering Irons

Stock No.	Soldering Irons		Your Cost	Extra Tips	
	Watts	Tip Dia.		Stock No.	Your Cost
C15190	100	3/8"	\$2.91	C14903	21c
C15191	130	1/2"	3.50	C15168	32c

ESICO Thermostatic Control Stand

(G) Use of this unit makes it impossible to over-heat iron. Iron can be maintained at any desired temperature while in stand. When removed from control, full current is applied to iron. For irons with up to 1" diam. tips. Shipping weight 3 lbs. **\$3.82**
C14885—Stand Only. Your Cost.

Touch-Up Sprayer

(H) Designed to operate perfectly with very low pressure from spare tire or any other air container. Air-tight brass valve, adjustable brass spray tip, rubber hose and two 4-oz. jars. Very handy for touching up marred panels, cabinets and chassis. Shpg. wt. 3 lbs. **\$1.17**
C14705—Your Cost.

Power Sprayer

(J) Operates from the spark plug of any automobile. Will spray paint, lacquer—any free-flowing liquid. Complete with sprayer, pint jar, sparkplug air check valve, compression tank, set of adapters and 12-foot hose. Supt. wt. 6 lbs. **\$4.70**
C14704—Your Cost.

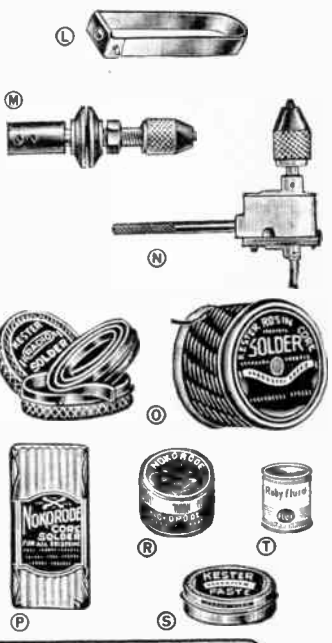

SERVICING TOOLS

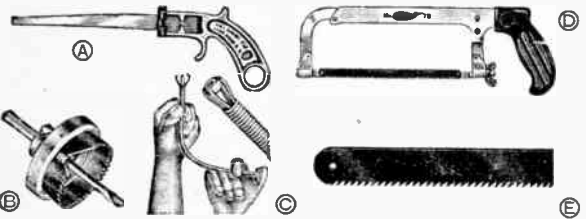

"All Purpose" Hack Saw

(A) Fits where ordinary hack saws cannot be used. Includes $7\frac{1}{2}$ " tapering blade. Very handy for tight places.

C17218—**Your Cost**..... **26¢**

Extra blades only.

C17279—**Your Cost, Each**..... **12¢**

MISENER

Rotary Hack Saw

(B) The ideal hole cutter for wood, metal bakelite, etc. With $\frac{3}{8}$ " round shank. Many other sizes available.

Stock No.	Hole Size	Cost Ea.
C17250	$\frac{1}{8}$ "	\$2.42
C17251	$\frac{1}{4}$ "	2.42
C17252	$\frac{3}{8}$ "	2.42
C17253	$\frac{1}{2}$ "	
C17254	$\frac{5}{8}$ "	
C17255	$\frac{3}{4}$ "	2.47
C17256	$\frac{7}{8}$ "	

Combination Tool cuts holes from $\frac{3}{8}$ " to $2\frac{1}{2}$ " in eleven $\frac{1}{4}$ " steps. $\frac{3}{8}$ " round shank.

Stock No. Hole Size Cost Ea.
C17265 $\frac{3}{8}$ " to $2\frac{1}{2}$ " \$10.14

Extra Shanks

C17267 $\frac{1}{8}$ " Round 1.01

C17268 $\frac{3}{8}$ " Round 1.01

Shank for Hand Brace

C17269 1.01

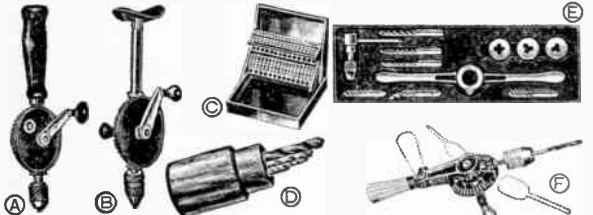

Standard Hand Drill

(A) 11" overall length with hardwood handle $5\frac{1}{2}$ " long. $3\frac{1}{2}$ " gear wheel meshed with small gear at 4:1 ratio $\frac{1}{4}$ " capacity chuck with 3 spring-controlled case-hardened jaws accurately centered to hold drill bits true and steady.

C14727—**Your Cost**..... **\$1.47**

Breast Drill

(B) $12\frac{1}{2}$ " long, full-size breast plate and $3\frac{1}{2}$ " gear meshed with small gears at 4:1 ratio. $\frac{3}{8}$ " capacity chuck. A good husky tool nicely finished.

C14726—**Your Cost**..... **\$2.25**

Drill Case

(C) Compact metal drill case with handy tap drill index numbered from 1 to 60. Lifting cover automatically brings up drills for easy selection. Size: $4\frac{11}{16}$ " x $4\frac{13}{16}$ " x $1\frac{13}{16}$ "

C14702—**Your Cost**..... **\$2.45**

Set of 9 Steel Drills

(D) Sizes $\frac{1}{16}$ to $\frac{3}{16}$ ". Good fast cutting steel. Correctly ground. Will hold edge. Popular sizes for radio work. In hardwood box.

C14708—**Your Cost**..... **\$1.29**

Tap, Drill and Die Set

(E) Contains three 1" diameter dies (4-36, 6-32, 8-32) with die stock; three taps (4-36, 6-32, 8-32) and 3 matching tap drills for these taps. Tap holder also included. All housed in natural mahogany case. Shpg. wt. 3 lbs.

C14994—**Your Cost**..... **\$2.25**

Swivel Head Hand Drill

(F) A hand drill that works around corners! Chuck head adjusts and locks to seven different positions, handle adjusts and locks anywhere along 180° arc. Drills true, because flat hub base always remains parallel to the drill bit. Chuck size, $\frac{1}{4}$ ". Overall length, $8\frac{1}{2}$ ". Shpg. wt. 2 lbs.

C14724—**Your Cost**..... **\$3.72**

FLEX-O-CLAW

(C) Flexible remote grasping tool for work in otherwise inaccessible places. Available in 4 lengths as below. $\frac{1}{4}$ " dia.

C14728 (12") **Your Cost**..... **\$0.66**

C14729 (15") **Your Cost**..... **.83**

C14730 (18") **Your Cost**..... **1.00**

C14731 (22") **Your Cost**..... **1.17**

WHALE Hack Saw

(D) Tenite Handle. Adjustable for 8" to 12" blades; blade may be faced in four directions. Nickel-plated stock .165" x $\frac{5}{8}$ "; depth $3\frac{3}{8}$ ". Complete with 10" blade. Excellent addition to radio mechanics' and electricians' toolbox. Shpg. wt. 2 lbs.

C17282—**Your Cost**..... **\$1.13**

Flex. Hack Saw Blades

(E) Extra hard. Extra flexible. Longer life. Scientifically heat treated for hardness and flexibility. For all standard frames. Shpg. wt. approx 1 lb. per doz. All are $\frac{1}{2}$ " wide and .025" thick.

No.	Length	Teeth*	Ea.	Doz.
C17273	10"	18	7c	67c
C17274	10"	24	7c	67c
C17275	12"	18	8c	80c
C17276	12"	24	8c	80c

*Number of teeth per inch.

GENERAL PURPOSE CIRCLE CUTTERS

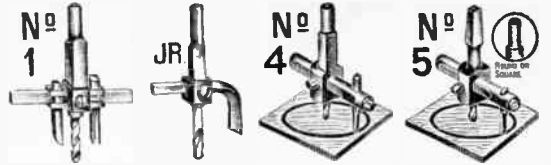

Provides an easy, accurate method for cutting clean circular holes in brass, aluminum, steel, wood, bakelite, etc. Of fine heat-treated steel. Used with ordinary hand brace or slow speed drill press. All American-made.

Stock No.	Type No.	Cuts Hole	Shank Style	Type Work	Your Cost
C14720	JR	$\frac{3}{8}$ " to $2\frac{1}{2}$ "	Round	Light	\$0.78
C14711	4	$\frac{1}{2}$ " to 4"	Round	Medium	1.30
C14713	5	1" to $5\frac{1}{2}$ "	Round	Heavy	1.88
C14715	5	1" to $5\frac{1}{2}$ "	Square	Heavy	1.88
C14717	1†	$\frac{1}{2}$ " to 4"	Round	Medium	1.88
C15069	5	$1\frac{1}{4}$ " to 8"	Square	Ex. Heavy	3.88

†Has extra beading cutter.

Replacement Drills and Blades

C15068—Drill for use with C15069. **Your Cost**..... 35c

C14716—Blade for use with all above except C15069 and C14720. **Your Cost**..... 30c

C15070—Blade for use with C15069. **Your Cost**..... 50c

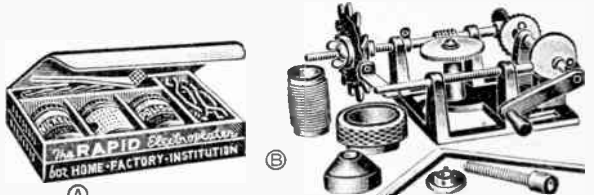

"RAPID" Electroplaters

(A) Small portable electroplating outfits for home or workshop. Easy to use. For replating jewelry, utensils, radio parts, etc. Each kit contains: 1-oz. of plating compound; 1-oz. of metal polish; 1 anode brush; battery wires with clips attached; full instructions. Requires two No. 6 cells (not supplied). Wt. 1 $\frac{1}{2}$ " lbs.

C15359—Nickel Plating Outfit. C15360—Copper Plating Outfit.

C15370—Cadmium Plating Outfit. **Your Cost, Each**..... **\$1.10**

C15371—Silver Plating Outfit. **Your Cost, Each**..... **\$1.47**

Extra Compound

Additional 1-oz. bottles of compound (plate 125-175 sq. in.):

C15372—Nickel Compound. C15373—Copper Compound **37¢**

C15374—Cadmium Compound. **Your Cost, Each**..... **37c**

C15375—Silver Compound. **Your Cost, Each**..... **73c**

Industrial Kit

Comprised of 8-oz. Electrolyte, Sterling Silver Applicator, 4-oz. metal cleaner. Shpg. wt. 3 lbs.

C15376—**Your Cost**..... **\$7.50**

Deluxe Coil Winder

(B) Will wind honey comb, spider-web, or solenoid coils of various widths and diameters equal in appearance to factory made coils. Includes all accessories for winding the various types. Has recorder and indicator that counts turns. Instructions included. Shpg. wt. 6 lbs.

C14725—**Your Cost**..... **\$4.95**



SPEDEX Wire Stripper

(A) Strips all types of wire instantly. Pocket size, fast (up to 1000 wires per hour) positive acting. Works on ends or any place along wire. Will not damage solid or stranded wire. Shpg. wt. 2 lbs. *Has "Stay Open Feature."

Size	Standard Stock No.	Your Cost	Deluxe Stock No.	Your Cost
14 to 24-wire	C15538	\$3.53	C15565*	\$4.70
12 to 20-wire	C15537	3.53	C15566*	4.70
10 to 18-wire	C15539	3.53	C15567*	4.70

(B) Replacement Blades for either of above models.

Stock No.	Wire Sizes	Your Cost
C15596	12 to 20	88c
C15597	11 to 24	88c
C15598	10 to 18	88c
C15599	For parallel No. 18 POSJ or similar wire.	88c

SPEDEX Wire Stripper Kit

(C) Kit complete with wire stripper and 7 different size blades in permanent steel box. For radio servicemen, electricians and manufacturers. Handle No. 8 to No. 30 wire.

C15568—Deluxe kit complete with automatic stripper **\$10.00**

and all blades. **Your Cost**.....

C15569—Standard kit complete with all blades. **Your Cost**..... **\$8.82**

Push Back Wire

Solid Tinned Copper Core Type

No stripping is necessary. Just push back the double cotton-covered moisture-proofed braid. No. 20 wire. Four colors for circuit identification. Weight 2 lbs. per 100 feet.



Stranded Tinned Copper Core Type

Very flexible wire of multi-strand tinned copper; equivalent to No. 20. Cotton braid pushes back easily. Available in 4 colors. Weight, 2 lbs. per 100 feet.

25-Foot Coils
C16350—Red **C16352**—Black
C16351—Green **C16353**—Yellow
 Your Cost (10 For \$2.25), Per Coil..... **24c**

50-Foot Coils
C16358—Red **C16360**—Black
C16359—Green **C16361**—Yellow
 Your Cost (10 For \$4.23), Per Coil..... **47c**

100-Foot Coils
C16366—Red **C16368**—Black
C16367—Green **C16369**—Yellow
 Your Cost (10 For \$8.19), Per Coil..... **91c**

1000-Foot Spools
C16374—Red **C16376**—Black
C16375—Green **C16377**—Yellow
 Your Cost, Per Spool..... **\$6.95**

25-Foot Coils
C16354—Red **C16356**—Black
C16355—Green **C16357**—Yellow
 Your Cost (10 For \$2.43) Per Coil..... **27c**

50-Foot Coils
C16362—Red **C16364**—Black
C16363—Green **C16365**—Yellow
 Your Cost (10 For \$4.68), Per Coil..... **52c**

100-Foot Coils
C16370—Red **C16372**—Black
C16371—Green **C16373**—Yellow
 Your Cost (10 For \$8.91), Per Coil..... **99c**

1000-Foot Spools
C16378—Red **C16380**—Black
C16379—Green **C16381**—Yellow
 Your Cost, Per Spool..... **\$7.95**

HOOK-UP and MAGNET WIRE

Colored Rubber Wire

Stranded and tinned 18 gauge copper wire covered with a live rubber compound. Very flexible; easy to strip. Solders instantly. Available in three colors.



25-Foot Coils
C16272—Red } Your Cost Each
C16273—Black } 5 For **22c**
C16274—Green } \$1.00

1000-Foot Spools
C16108—Red } Your Cost Each
C16109—Black } **\$7.85**
C16110—Green }

No. 16 RUBBER COVERED
C16280—Black **C16281**—Red
 50 Ft. 100 Ft. 500 Ft.
 Your Cost 62c \$1.18 \$5.49

Stranded No. 14 Gauge
C16121—Black **C16120**—Red
 25 Ft. 50 Ft. 100 Ft.
 Your Cost 55c \$1.05 \$1.99

Stranded No. 12 Gauge
C16122—Black **C16123**—Red
 25 Ft. 50 Ft. 100 Ft.
 Your Cost 72c \$1.39 \$2.65

Multi-Conductor Cable

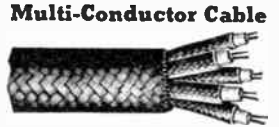

A high grade, heavily insulated cable. Each lead has a different colored rubber jacket for easy identification. 18 gauge, stranded tinned copper wire. Cotton braid overall.

No.	Wires	Per Ft.	100 Ft.
C16089	3	4c	\$3.60
C16090	4	5c	4.50
C16091	5	6c	5.40
C16092	6	7c	6.30
C16093	7	8c	7.20
C16094	8	9c	8.10
C16095	9	10c	9.00
C16096	10	11c	9.90

Giant Slewing

No. 2 Spaghetti I.D. 3/2", 36" long. High Voltage oil varnish impregnation. Black only.
C15956—10 For \$1.44
 Per Length..... **16c**

Resistance Wire on Handy Size Spools

High grade resistance wire in small quantities for use in highly sensitive instruments where accurately determined resistance values, secured through the employment of a high grade alloy wire, are necessary.

Wire Gauge	Ohms Per Ft.	Enameled		Bare	
		Stock No.	Ft. In. Spool	Stock No.	Ft. In. Spool
14	.04603	C16600	20	C16614	24
16	.07318	C16601	31	C16615	38
18	.1164	C16602	40	C16616	46
20	.1850	C16603	57	C16617	81
22	.2941	C16604	77	C16618	126
24	.4678	C16605	104	C16619	190
26	.7438	C16606	141	C16620	277
28	1.183	C16607	160	C16621	399
30	1.879	C16608	182	C16622	560
32	2.990	C16609	205	C16623	765
34	4.756	C16610	230	C16624	1092
36	7.560	C16611	253	C16625	1482
38	12.02	C16612	279	C16626	1881
40	19.11	C16613	309	C16627	2308

Your Cost Each, Any Spool **39c**

Finest Grade Magnet Wire



Highest quality copper wire. Excellent for re-winding power transformers and chokes, winding coils or any other radio and electrical purpose. Ideal for use in shops, schools, laboratories, etc.

Double Silk Covered

Stock No.	Size B&S	Ft. Per Lb.	Your Cost 1/4 Lb.	Your Cost 1/2 Lb.
C20962	18	199	\$0.37	\$0.71
C20963	20	311	.41	.73
C20964	22	494	.43	.76
C20965	24	778	.45	.84
C20966	26	1220	.53	.98
C20967	28	1910	.62	1.13
C20968	30	2960	.74	1.32
C20969	32	4570	.94	1.64
C20970	34	6980	1.25	2.27
C20971	36	10500	1.72	3.32

Double Cotton

Extremely popular with amateurs and experimenters. Highest quality.

Stock No.	Size B&S	Ft. Per Lb.	Your Cost 1/4 Lb.	Your Cost 1/2 Lb.
C20973	16	122	\$0.24	\$0.39
C20974	18	192	.24	.43
C20975	20	298	.26	.49
C20976	22	464	.32	.54
C20977	24	711	.37	.63
C20978	26	1080	.39	.69
C20979	28	1630	.47	.84
C20980	30	2420	.52	.98
C20981	32	3500	.69	1.19
C20982	34	4920	.84	1.51
C20983	36	6660	1.08	1.91

Plain Enameled

Stock No.	Size B&S	Ft. Per Lb.	Your Cost 1/4 Lb.	Your Cost 1/2 Lb.
C20950	16	125	\$0.20	\$0.33
C20951	18	202	.20	.35
C20952	20	319	.22	.37
C20953	22	506	.22	.37
C20954	24	801	.24	.39
C20955	26	1280	.26	.43
C20956	28	2030	.29	.47
C20957	30	3220	.32	.51
C20958	32	5100	.36	.55
C20959	34	8080	.39	.67
C20960	36	12800	.50	.78
C20961	38	20300	.67	.98

High Grade Magnet Wire on Handy Size Spools

Economical sized spools of high grade magnet wire for those desiring less than 1/4 lb. All spools are plainly marked with the length of wire contained on the spool as well as the size. Available in double cotton, double silk and enameled insulation.

Gauge	Double Cotton		Double Silk		Enameled	
	Stock No.	Ft. In. Spool	Stock No.	Ft. In. Spool	Stock No.	Ft. In. Spool
14	C16500	21	C16514	19	C16528	25
16	C16501	33	C16515	25	C16529	40
18	C16502	42	C16516	31	C16530	48
20	C16503	60	C16517	42	C16531	85
22	C16504	81	C16518	60	C16532	133
24	C16505	110	C16519	83	C16533	200
26	C16506	148	C16520	101	C16534	292
28	C16507	168	C16521	119	C16535	420
30	C16508	192	C16522	141	C16536	590
32	C16509	216	C16523	163	C16537	805
34	C16510	242	C16524	190	C16538	1150
36	C16511	266	C16525	219	C16539	1560
38	C16512	291	C16526	243	C16540	1980
40	C16513	325	C16527	275	C16541	2430



Your Cost Each, Any Spool **20c**

Spaghetti on Spools

High grade varnished cambric tubing. 5000 V. dielectric strength. On fibre spools, 8 and 12-yard lengths.

For No. 12 wire, in 8-yard lengths: C15951 —Red C15952 —Green C15954 —Yellow C15955 —Black
For No. 14 wire, in 8-yard lengths: C15750 —Red C15752 —Green C15751 —Yellow C15753 —Black
For No. 18 wire, in 12-yard lengths: C15754 —Black

Any of Above Sizes, Your Cost, Per Spool..... **67c**



Belden WIRE and CABLE

Transmission Line Cables



8216

8216: 72 ohm coax. Puncturing voltage 30,000. No. 14, 19 No. 27 tinned; low-loss rubber ins., tinned copper braid, rubber overall; .460" OD. 37 mmf/ft., VP 56%, atten./C' .51 db at 1 mc, 2.9 db at 10 mc.
C20859—Bulk. **Your Cost** per ft. 14c
C20937—50 ft. spool. \$5.88
C20936—250 ft. spool. \$28.38



8204

8204: 72 ohm twisted pair. No. 18, 7 No. 26 tinned; cotton wrap, rubber ins. Cabled with weather-resistant cotton braid overall; .190" OD. 21 mmf/ft. VP 61%. Atten./C' .53 db at 1 mc, 12.3 db at 100 mc.
C20860—Bulk. **Your Cost** per ft. 3c
C16174—500 ft. spool. \$13.42



8209

8209: 72 ohm shielded twisted pair, conductors and outer cotton like 8204, but cabling includes paper wrap and tinned copper braid; .235" OD. 32 mmf/ft. between conductors, VP 57%, atten./C' 1.1 db at 1 mc, 14.9 db at 100 mc.
C20861—Bulk. **Your Cost** per ft. 6c
C16162—500 ft. spool. \$25.23



8205

8205: Twisted pair. No. 22, 7 No. 30 tinned, rubber ins. Cabled with weather-resistant cotton braid; .173" OD.
C20862—Bulk. **Your Cost** per ft. 2c
C16171—500 ft. spool. \$8.41



8452

Rubber Jacketed Portable Cord

No. 18, 41 No. 34 bare copper; cotton wrap, 1/4" rubber ins. Cabled with fillers, cotton wrap, 1/2" rubber overall.



8453

Bulk		100 ft. spool	
Mfr's No.	Stock No.	Your Cost	Stock No.
8452 2—.245"	C20910	5c	C20909
8453 3—.275"	C20880	6c	C20879
8454 4—.265"	C20881	7c	C20882



8664

Shielded Auto & Aircraft Radio Wire



8656

8664: No. 28 solid tinned steel, yarn braid, polyethylene ins., tinned copper braid, vinyl cover; .260" OD., 15 mmf/ft.
C20863—Bulk. **Your Cost** per ft. 7c
C20884—100 ft. spool. \$5.91



8799

Flex. stranded tinned copper, cellophane wrap, rubber ins., lacquered cotton braid, tinned copper braid. .170", .195", .225" OD.

Bulk		1000 ft. spool	
Mfr's No.	Stock No.	Your Cost	Stock No.
8656 No. 16	C16219	5 1/2 c	C20864
8655 No. 14	C16218	7c	C20865
8654 No. 12	C16223	8c	C20866

Intercom and P.A. Cable

8799: Twisted pair, No. 18 solid bare copper; plastic ins. Tinned copper braid overall; .155" OD.

C20867—Bulk. **Your Cost** per ft. 3c
C20914—100 ft. spool. \$2.71
C20911—500 ft. spool. \$12.57



8941



8943

General Use Hook-Up Wire

Tinned conductor, cellulose acetate yarn wrap, cel. acct. braid, lacquer coating, 1000 volts breakdown. OD's from .072" to .087". Comes in black, blue, green, red, yellow. **Specify color.**

Package	No.	Stock No.	Each	Stock No.	Each
8941, No. 20 solid	8943, No. 20 stranded				
25 ft.	C16066	\$0.29	C16068	\$0.32	
100 ft.	C16080	.88	C16081	1.01	
1000 ft.	C16067	7.43	C16069	8.61	
8945, No. 18, solid	8947, No. 18 stranded				
25 ft.	C16070	\$0.35	C16073	\$0.35	
100 ft.	C16071	1.12	C16074	1.14	
1000 ft.	C16072	9.53	C16075	9.90	
8938: No. 14 stranded, red and black only. Specify color.					
C16156	—25 ft. coil.	Your Cost	\$0.53		
C16082	—100 ft. spool.	1.82		
C16157	—500 ft. spool.	8.51		

Shielded Phono-Pickup Cable

8431: Flexible and limp. No. 24, 16 No. 36 tinned; rubber ins., tinned copper braid, cotton braid overall; .085" OD.

C20872—Bulk. **Your Cost** per ft. 2 1/2 c
C20848—100 ft. spool. \$2.11



8841



8839

Low-Loss R-F Push-Back Wire

Tinned conductor two cellulose acetate yarn braids, waxed. 1000 volts breakdown. OD's from .067" to .095". Comes in black, blue, green, red, and yellow. **Specify color.**

Package	Stock No.	Each	Stock No.	Each
8841, No. 20 solid	8839, No. 20 stranded			
25 ft.	C16246	\$0.35	C16249	\$0.39
100 ft.	C16247	1.10	C16248	1.23
1000 ft.	C16245	9.39	C16250	10.79
8861, No. 20 solid	8844, No. 18 stranded			
25 ft.	C16199	\$0.39	C16208	\$0.42
100 ft.	C16204	1.22	C16205	1.37
1000 ft.	C16203	10.76	C16209	12.19
8863, No. 16 solid	8862, No. 16 stranded			
25 ft.	C16220	\$0.45	C16230	\$0.49
100 ft.	C16221	1.49	C16231	1.61
1000 ft.	C16222	13.34	C16232	14.74

Microphone Cable, Vinyl Covered

8411: No. 25 stranded tinned copper and steel mixed, polyethylene ins., tinned copper braid; 40 mmf/ft., .150" OD.

C20857—25 ft. coil. **Your Cost** 98c
C20858—100 ft. spool. \$3.36



8411



8401



8422



8423



8014

8401: Same construction as 8411 but heavier ins., 25 mmf/ft., .200" OD.

C20846—25 ft. coil. **Your Cost** \$1.30
C20847—50 ft. coil. 2.60
C20844—100 ft. spool. 4.76

8422: 2-cond. No. 22, 16 No. 34 tinned copper, polyethylene ins. Cabled with cotton braid and tinned copper braid; .240" O.D. 16 mmf/ft. between conductors, 28 mmf/ft. to ground. Vinyl overall.
C20868—Bulk. **Your Cost** per ft. 7c
C20874—25 ft. coil. \$1.54
C20875—50 ft. coil. 3.01
C20876—100 ft. spool. 5.74

Shielded Cable, Rubber Overall

No. 20, 26 No. 34 tinned copper; cotton wrap, rubber ins. Cabled with cotton braid, tinned copper braid, cotton wrap, rubber overall.

Package Stock No. Each Stock No. Each

8423, 3-cond.* 8424, 4-cond.†
Per ft. C20869 8c C20870 10c
.50 ft. C20843 \$ 3.56 C20878 \$ 4.29
250 ft. C20845 16.76 C20877 20.45
* .280" OD. † .305" OD.

Indoor Aerial and Lead-In Wire

8014: Indoor aerial, flexible No. 25, 13 No. 36 tinned, vinyl ins.

C16130—25 ft. card. **Your Cost** 17c
C16131—500 ft. spool. \$1.73

8200: Lead-in, No. 18, 7 No. 27 tinned, rubber ins., .126" OD.

C16228—100 ft. spool. **Your Cost** 81c
C16229—500 ft. spool. \$3.35
C16227—1000 ft. spool. 6.15

8206: Same, but tinned copper braid shield overall. .155" OD.

C20871—**Your Cost** per ft. 2 1/2 c
C20888—250 ft. spool. **Your Cost** \$5.25

Test Prod Wire, Flexible and Limp

No. 18, 65 No. 36 tinned; cotton wrap, rubber overall; red or black. **Specify color.**

8899: 5000 volts ins., .140" OD.

C16336—7 ft. red, 7 ft. black. **Your Cost** 28c

C16335—100 ft. spool. \$1.50
C16337—1000 ft. spool. \$13.03

8898: 10,000 volts ins., .230" OD.

C16332—Bulk. **Your Cost** per ft. 3c
C16331—100 ft. spool. \$2.48

Cathode-Ray Tube Lead Cable

No. 20, 7 No. 28 tinned; polyethylene ins., red cotton braid, lacquer coating.

8869: 10,000 volts ins., .140" OD.

C20889—25 ft. spool. **Your Cost** 69c
C20890—100 ft. spool. \$1.93

8868: 20,000 volts ins., .200" OD.

C20891—25 ft. spool. **Your Cost** \$1.12
C20892—100 ft. spool. \$3.61

Litz Wire, for RF Coils

8817: No. 41, 2 nylon wraps.

C16065—100 ft. spool. **Your Cost** 23c

Tinned Bus Bar, 100-ft. Coils

C16111 8012, 90c
No. 14.
C16112—8011, No. 12 \$1.29



8338



8885

Rubber-Insulated Push-Back Wire

No. 20 tinned, cotton wrap, vulcanized rubber ins., yarn braid, lacquer coating. 2000 volts breakdown. Solid is .075" OD., stranded is .080" OD. In green, blue, red, yellow, and black. **Specify color.**

Package	Stock No.	Each	Stock No.	Each
8837, solid	8838, stranded			
25 ft.	C16258	\$ 0.36	C16261	\$ 0.39
100 ft.	C16259	1.15	C16262	1.23
1000 ft.	C16260	10.09	C16263	10.79

Shielded Hook-Up for Grid Leads, etc.
8885: No. 20, 10 No. 30 tinned; rubber ins., yarn braid, lacquer coat, tinned copper braid overall; .110" OD. 4000 volts breakdown.

C16293—25 ft. coil. **Your Cost** 72c
C16294—100 ft. spool. \$2.24



A



B



C



D

3 and 5 Conductor Shielded Cable

A Three color-coded stranded conductors in tightly woven tinned copper shield. 1/8" outer covering of high percentage rubber.

C16145—Per Foot..... **7 1/2¢**

C16206—50-Foot Roll... \$3.65

C16207—100-Foot Roll... 7.02

Similar to above, but 5-conductor.

C16100 100-Foot \$9.78

Your Cost per Foot **11¢**

Ultra Low Loss Coaxial Cable

B For use in high frequency transmission lines, photoelectric work, or wherever coaxial cable is required. The dielectric is solid flexible low loss Polyethylene thermoplastic. .185" in diameter with a woven copper shield braid and heavy vinyl outer covering. Inner conductor is 7 strands of No. 26 copper wire. Impedance 58 ohms. Capacitance per foot 27 mmfd. .275" O.D. Available in 75-foot lengths only.

C17127—Per 75 Ft. Length. **\$3.75**

Heavy Rubber Cord

E The thick belt of flexible rubber that covers the conductor is made of smooth oil-resisting, abrasion proof high quality "Jacket."

No.	Size	Ft. 100 Ft.	
C20945	18—2-wire	4c	\$3.60
C20946	16—2-wire	4 1/2c	4.05
C20947	14—2-wire	12c	10.80
C20948	18—3-wire	5c	4.50



A

B

Thermoplastic Hook-up Wire

A Underwriters listed. 10,000 volt breakdown test. New thermoplastic insulation strips clean and is oil and acid resistant. Will withstand 180° F. For use where high conductivity and low loss is essential. Shpg. wt., per 25 ft., 4 oz. Available in Black, Red, Blue, Green and Yellow. Specify color.

C16382—25 ft. #20 Solid... 24c
C16383—100 ft. #20 Solid... 86c
C16384—25 ft. #20 Stranded 28c
C16385—100 ft. #20 Stranded 99c

No. 18 Lead-In Wire

B Solid tinned copper. 3/4" rubber easy-strip insulation. For lead-ins, ground leads or aerials. Shpg. wt., 2 lbs. per 100 ft. Specify length when ordering.

C16200 25 ft. Your Cost single coil... **22¢**

Lots of 10... \$1.98

C16215—50 ft. Your Cost single coil... **37¢**

Lots of 10... \$3.33

C16216 100 ft. Your Cost single coil... **70¢**

Lots of 10... \$6.30

C16217—1000 ft. 5.95

Single Conductor Crystal Mike Cable

D Flexible stranded tinned copper single conductor; tinned copper braid shield; cotton wrap and lacquered braid, rubber overall. Outside diam. .280".

C20842—Per Foot... **5 1/2¢**

C16333—50-Foot Roll... \$2.40

C16334—100-Foot Roll... 4.70

Low Impedance Crystal And Velocity Mike Cable

C Consists of two conductors, color coded in a closely woven tinned copper shielding with outer covering of rubber. Abrasion proof.

C16079—Per Foot... **6 1/2¢**

C16201—50 Foot Roll... \$3.07

C16212—100-Foot Roll... 5.49

Parallel All Rubber Lamp Cord

F Both conductors sheathed in coating of tough live rubber. Groove between conductors allows easy separation without fear of ruining insulation. In Black and Brown. Specify color desired. Shpg. wt. per 100 ft., 3 lbs.

C20920 18 Gauge Your Cost. Per Foot... **2¢**

Per 100 Feet... \$1.90

Per 500 Feet... 9.25

Parallel Rayon Cord

G Popular type for connecting radio receivers, lamps, etc. Overall covering of rayon braid.

18 Gauge—1/8" Wall
C20836 Maroon C20838—Brown
C20837—Old Gold

Your Cost. Per Foot **2 1/2¢**

100 Ft. \$2.18 500 Ft. \$10.38



C

D

Copper Aerial Wire

C Made of the finest copper obtainable. All rolls are guaranteed to be full length and standard gauge as specified. For any type aerial.

Bare Stranded—75 Ft. Coils

Stock No.	Size	Per Coil	10 Coils
C16041	7/26	\$0.29	\$2.75
C16042	7/24	.42	3.99
C16043	7/22	.63	5.98

Bare Stranded—100-Ft. Coils

Stock No.	Size	Per Coil	10 Coils
C16113	7/26	.37	3.51
C16114	7/24	.54	5.13
C16115	7/22	.81	7.70

Enameled Stranded—

75-Ft. Coils

C16045 7/22 1.05 9.00

Enameled Stranded—

100-Ft. Coils

C16117 7/22 1.34 11.50

Solid Enameled—100-Ft. Coils

C16118 No. 14 .95 8.80

C16119 No. 12 1.47 13.00

C16129 No. 10 2.19 20.81

Indoor Antenna Wire

D Multi-strand flexible copper wire covered by a brown mercerized cotton braid. For indoor or a.c.-d.c. antenna use. 25-ft. hank.

C16155—Your Cost... **17¢**

C16167—100-ft. Coil... 53c

WIRE AND CABLE

Transmission Cable

H Consists of twisted rubber-covered conductors covered by a black weatherproof cotton outer braid. Shpg. wt. (100 ft.), 4 lbs.

C17152—Per Foot... **2 1/2¢**

Per 100 Foot Coil... \$2.00

Telephone Wire

J For general use and inter-communication phones. 2-Conductor No. 19 Gauge. 1/2 R.C.

C20895—100 Ft. 500 Ft. 1000 Ft. Your Cost \$2.64 \$13.10 \$25.95

C20896—3-Conductor No. 19 Your Cost \$3.90 \$19.25 \$37.95

Cotton Twisted Pair

K 18 Gauge. 1/2" R.C. wire with a cotton covering. Yellow and green mixture.

C20902—Your Cost **3¢**

Per Foot... Per 250 Ft. Your Cost \$6.75

Shielded Lead-In and Hook-Up Wire

L A 10-strand wire covered with live rubber, a waxed cotton braid and a woven, tinned shield.

C16240—Per Ft. 50 Ft. 100 Ft. Your Cost 3c \$1.35 2.25

Copper Shielding

M Flexible tinned copper shielding that slides over cables and bunched conductors. Heavily tinned to prevent corrosion.

Stock No.	In. Dia.	Per Ft.	Per 100 Ft.
C16233	3/8"	2c	\$1.66
C16237	1/4"	2c	1.70
C16238	3/16"	3c	2.66
C16239	1/2"	5 1/2c	5.04

Low-Loss High Frequency Coaxial Cable



AMPHENOL

TWIN 300 LEAD

75 OHM AMPHENOL 14-080

75 OHM AMPHENOL 14-023

75 OHM AMPHENOL 14-023

75 OHM AMPHENOL 14-023

75 OHM AMPHENOL 14-023

75 OHM AMPHENOL 14-023

75 OHM AMPHENOL 14-023

75 OHM AMPHENOL 14-023

75 OHM AMPHENOL 14-023

75 OHM AMPHENOL 14-023

75 OHM AMPHENOL 14-023

75 OHM AMPHENOL 14-023

75 OHM AMPHENOL 14-023

75 OHM AMPHENOL 14-023

75 OHM AMPHENOL 14-023

75 OHM AMPHENOL 14-023

75 OHM AMPHENOL 14-023

75 OHM AMPHENOL 14-023

75 OHM AMPHENOL 14-023

75 OHM AMPHENOL 14-023

75 OHM AMPHENOL 14-023

75 OHM AMPHENOL 14-023

75 OHM AMPHENOL 14-023

75 OHM AMPHENOL 14-023

75 OHM AMPHENOL 14-023

Dielectric is a solid flexible low-loss mechanically stable thermoplastic of Polyethylene proven most efficient in high frequency transmission circuits. All cables listed below are impervious to acids, alkalis, oils and gasoline. All have a woven copper shield braid over the Polyethylene dielectric with a heavy Vinyl outer covering overall. Many other single and twin conductor types available. Write for technical bulletin—C19900 sent FREE on request.

Stock No.	Amphenol No.	Ohms Imped.	Cap./ft. mmf.	Wire Size	Dielectric O.D.	Cable O.D.	Your Cost Per Ft.
C17120	RG 8U	52	29	7x21	.285"	.405"	19c
C17121	RG 11U	75	20	7x26	.285"	.405"	20c
C17124	RG 22U	95	16	#20	.116"	.184"	24c
C17122	RG 58U	50.5	28	#20	.116"	.195"	11c
C17123	RG 59U	73	22	#22	.146"	.242"	11c

Twin Lead Transmission Line

300 ohm Amphenol 14-056 represents the latest design in RF transmission line. Provides proper match of antenna to all standard 300 ohm input FM and television receivers. 300 ohm recommended by RMA for use with television receivers in broad band operation. For use indoors or outdoors. Low-Loss Polyethylene insulation is efficient, tough and weather resistant. Will withstand severe weather conditions.

C17130—Per foot... **3¢**

Per 100 feet... \$2.85

75 Ohm Amphenol 14-080. Especially for dipoles of 72 ohm impedance.

C17131—Per foot... **2¢**

Per 100 feet... \$1.90

75 Ohm Amphenol 14-023. For amateur transmitting antenna systems. Conservatively rated at 1000 watts. at 30 MC or lower frequency.

C17132—Per foot... **7¢**

Per 100 feet... \$6.48

AUTO

Antennas • Accessories

Reliance Auto Radio Suppressors

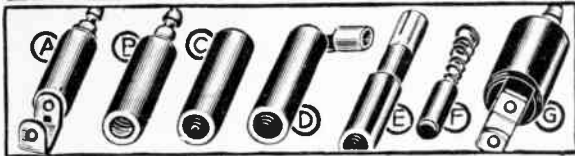

High quality suppressors housed in black molded cases.

- No. Type Description**
C5283 A Standard Spark Plug
C5246 A Special for Ford V8
C5278 B Compact Spark Plug
C5247 B Compact Spark Plug Type for Ford V8
C5253 C Cable Type for Buick
C5285 D Elbow Cable Type
C5279 E Standard Distributor
C5293 F Distributor Type for Ford 1936 and earlier
C5277 F Distributor Type for Ford 1937-38-39-40.
C5256 * Elbow Type for 1938 Plymouth
Your Cost Each **14¢**
 Per 10 Assorted **\$1.26**
 *Like "A" with "L" connector.

Wire Wound Units (G)
 Most efficient type. Do not impair motor efficiency. Low d.c. resistance, high inductance. Acts as r.f. choke. Extra rugged.
C5296 Spark Plug Type
C5297—Distributor Type
Either Type, Each **35¢**
 10 (Assorted) for **\$3.15**

Master Distributor Unit
 Hermetically sealed; impervious to moisture and heat. Eliminates need for other suppressors. D.C. resistance is 10,000 ohms.
C5284—Each **41¢**
 5 For **\$1.85**

MALLORY Replacement Vibrators

Mallory replacement vibrators for auto radios and battery operated household receivers. Precision made, Mallory vibrators are noted for their long life and trouble free service. All vibrators are rated at 6 volts except types W245A and W246 which are rated at 4 volts. Mallory Replacement Guide listed below is complete index to correct vibrator replacement. Guide is free on request.

No.	Type	Each	No.	Type	Each	No.	Type	Each
C6114	222	\$4.50	C6135	292	\$2.82	C7292	839	\$2.82
C6096	245	4.06	C6136	291	2.41	C6084	832	2.41
C7278	245A	4.06	C6137	298	3.23	C6085	853	2.41
C6088	245C	4.06	C6093	505P	2.03	C6086	854	2.41
C7280	W245A	4.06	C7285	506P	3.23	C7276	859	2.41
C6097	246	4.06	C6071	507P	2.03	C6076	860	2.41
C7281	246A	4.06	C6073	514	4.06	C7293	870	2.41
C7283	W246	4.06	C6074	716	4.06	C7296	901M	2.03
C6169	247	4.06	C6062	725C	4.50	C6079	952W	4.06
C6098	248	4.06	C6107	742	4.06	C6080	953W	4.06
C6171	249	4.06	C7289	743	4.06	C6081	954	4.06
C6127	271	4.88	C7277	748	4.06	C7275	1100	2.41
C6130	273C	4.50	C6063	825C	3.67			
C6167	273D	4.50	C6108	826C	3.23			

MALLORY Replacement Guide

Includes alphabetical listing of radio and vibrator power supplies by mfg. and model number. Gives Mallory replacement in each case. Also how to install 1946-47 auto radios. Other valuable information for the serviceman. Available on request at no charge. **C19993**.

NEW! MALLORY Vibrator Data Book

A complete Technical manual on the operation and application of vibrators.
C19992—Your Cost **98¢**

Mallory 2 V Vibrator Type T-4000

7-prong 2-volt synchronous vibrator used as replacement in General Electric portable sets models LB530 and LB530X. Size 2 3/4" x 1 1/2". Shpg. wt. 2 lbs.
C7274—
Your Cost **\$3.38**



Antenna Connector

C16714—Two piece metal container, fibre inside insulation.
Your Cost **6¢**
 10 For **54¢**



FORD V8 Condensers

C14219—Type A. For V8 models up to 1936.
C14199—Type B. For '37 to '41.
Your Cost Each, Either Type **29¢**



Wheel Static Eliminator

Eliminates front wheel noise. Easy to install in each hub cap. All rust proof.
C5294—
Your Cost Each **8¢**
 10 For **72¢**



Reliance "Universal Type" AUTO RADIO ANTENNAS

Auto Top Cowl or Fender Mount

Adjustable

3 section, 56-inch. Single hole mount on any contour. Ball swivel with Locking point permits adjustment to any angle and positive lock. Rugged rustproof construction, brilliant chromium plate. Has excellent pickup with minimum noise. Permanently attached shielded moistureproof 36-inch lead-in and bayonet adapter. Easy to install.



C22007—
Your Cost **\$2.67**

12" Lead extension for fender installation.

C22008—Each **44¢**

Disappearing

3 sections, 56 inch, telescopes to 4 inches exposed. Single hole mount. Rust, weather, and rattleproof. Triple chrome plate brass construction, with bakelite insulation and static discharge tip. Has highly efficient pickup with minimum noise. Has 48-inch coaxial lead-in with Geon plastic insulation, outer shielded loom, bayonet connector at one end, and coaxial swivel connector at other end.



C22009—
Your Cost **\$3.25**

Top Cowl Mounting 3-Section, 56-inch

Mounts securely on all car cowls, regardless of contour. Triple Chrome finish, sturdy rattleproof construction. Equipped with 36-inch moistureproof lead-in and bayonet adapter. This antenna is easy to install and will provide perfect noise-free reception regardless of car's position in relation to transmitter.



C22003—
Your Cost **\$2.67**

Cowl or Fender Mount Adjustenna

3 section, 65 inch A truly universal type antenna, easy to install. Heavy Chrome finish, sturdy rustproof construction. Has wonderful pickup with minimum noise. Equipped with 36-inch moistureproof lead-in and bayonet adapter for lead. Ideal item to sell for use on any type car and to conform to any body design.



C22002—
Your Cost **\$2.29**

3-Section, 66-inch Side Cowl Mount

2 stanchion universal mounting. Has rustproof triple chrome plated finish, sturdy rattleproof construction, and streamlined insulators. Equipped with 36" moistureproof lead-in. Also includes conversion kit for streamlined bodies and bayonet adapter for lead. A real buy.



C22006—
Your Cost Each **\$2.13**

100-Inch Side Cowl Mount

Same as above but 100-inch, 4 section.

C22001—
Your Cost Each **\$2.98**

2-Section 52-inch Underhood Type

Easy to mount telescopic underhood antenna for use on all automobiles with any type radio. Made of Admiralty brass, triple chrome plated. Rattleproof construction. Complete with 2 universal mtg. brackets, insulated lead-in and bayonet adapter.



C22004—Each **\$1.98**

3 Section 66 Inch

Complete as above. **\$2.43**
C22005—Each **\$2.43**

Generator Condensers

Standard auto radio condensers designed to eliminate generator noise. Fully shielded. Dirt and oil proof.
 No. Mfd. Each 10 For
C14220 .25 25c \$2.25
C14215 .5 27c 2.43
C14216 1.0 39c 3.50



Dual
 Similar to above, but 2—5 mfd., 2 leads.
C14198—Your Cost **49¢**

Ammeter Condenser

Eliminates noise in ammeter, horn, etc 10 For \$2.43
C14218—
Your Cost Each **27¢**



MOTOROLA 65 and 70 Condenser

High voltage condenser
 Consists of two .0008 mfd. 1000 volt units in a single housing. Four leads. Made by Sprague.
C14207—
Your Cost Each **59¢**
 5 For **\$2.65**



Dome Light Filter

Eliminates the noise in dome light wiring. Has condenser choke.
C14208—
Your Cost Each **19¢**
 10 For **\$1.50**



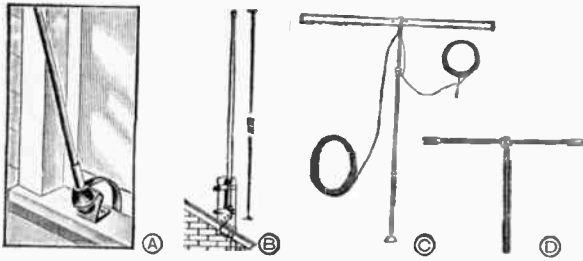

HOME RECEIVER Antennas and ACCESSORIES

Reliance Window Mast

(A) Fast, easy aerial installation in apartments, homes, and office buildings. Enjoy fine radio reception with an aerial installed in only 3 minutes. Attach lead-in strap, screw bracket down on sill, and the job is done. 3 section rod extends to 80 inches, telescopes to 40 in. Cadmium plated steel construction.
C22006—Your Cost..... \$1.73

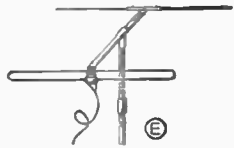

(B) Eliminates unsightly and dangerous horizontal wires. Insures clear, practically noise-free reception. Sturdily constructed and much easier to install than other types of antennas. Complete outfit includes a special 12-foot 4 section antenna mast of rustproof, flexible steel, 40 ft. of lead-in wire, 10 ft. of ground wire, lightning arrester, insulators, screws, two pipe straps, one strap mounting assembly, instructions for installation and use. Shpg. wt. 4 lbs.
C21824—Your Cost..... \$3.70

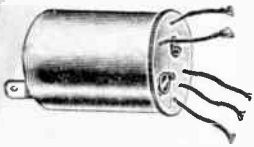

AMPHENOL All-Wave Antenna

(C) Noise free. 300 kc through 108 mc without switching. M-derived filter with 30-mc cutoff automatically takes broadcast band and short wave from the 65-ft. section which is polyethylene covered to reduce precipitation static. FM and other frequencies above 30 mc come from the 2" dia. horizontal dipole supported on the 5-ft. steel mast. Both sources feed through the 50-ft. 52-ohm coaxial lead-in. Coax eliminates interference due to transmission-line pickup. Standing-wave ratio in FM band varies between 1.05 and 1.57 to 1. Simple mounting includes base plate and tripod-guying clamp. Complete, ready to install. Shpg. wt. 9 lbs.
C22039—Amphenol 121-001..... \$17.49
Your Cost..... \$17.49

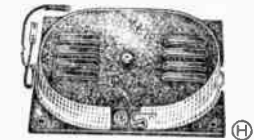

ICA Flexible FM Dipole

(D) Consists of two folded dipole elements spliced to 300 ohm twin lead transmission line. Flattened end insulators permits use indoors under carpet, on room molding, etc., as well as outdoors. Losses in line measure only .85 db per 100 ft. at 100 mc.
C22038—Your Cost..... \$1.15

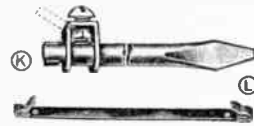

Plated Ground Rods
(K) Used wherever a pipe ground is not available. Heavy steel yoke for head, 3/8" heavy plated steel.
No. Feet Each Per 10
C17187 4 48c \$4.56
C17188 6 66c 6.27

Single Lead-in Strip
(L) Clip terminal each end.
C17101..... 5¢
Your Cost Each..... 5¢
10 For..... 45c

"Grip" Ground Clamp
(M) Makes a vise-like grip on pipe. Sharp-pointed screw makes perfect contact. Heavily plated.
C17015—Your Cost Each..... 8¢
10 For..... 72c
100 For..... \$6.17

Pipe Ground Strips
(N) Broad ground clamp adjustable to fit any size pipe up to 2" in diameter. Has clip for attaching ground lead.
C17102—Your Cost Each..... 5¢
10 For..... 45c

Arrester for Doublets
(O) An approved arrester for the doublet type of antenna. Air-gap type, insulated from ground. Porcelain case.
C16950—Your Cost Each..... 51¢

BRACH NEON Arrester

(P) Uses a NEON TUBE instead of an air-gap or resistance. Fully Underwriters Approved. Shpg. wt. 1 lb.
C16700..... 82¢
Your Cost..... 82¢

DUPLEX TYPE: Same as above, but for use with sets having doublet antennas.
C16701—Your Cost..... \$1.15

Porcelain Arrester

(Q) Housed in brown glazed porcelain; approved.
C16753—Your Cost Each..... 19¢
10 For..... \$1.70

Kwik-Klip Fastener

(V) Fastens wire quickly and easily to post insulators. Made of heavy galvanized wire, no tools necessary, can be used over and over again. **Clip only.**
C15671..... 32¢
Box of 100..... 32¢

Special Insulator Kit

Kit contains 50-type W, 4-type X as shown at right. With leather washers.
C15683—Your Cost..... 85¢

TACO FM Folded-Dipole Antenna

(E) Directional front and rear. Includes 60-ft. coil of 300-ohm transmission line, antenna with terminal block, 5-ft. wood mast, all hardware, and complete instructions. Shpg. wt. 6 1/2 lbs.
C22024—Your Cost..... \$5.59

Reflector assembly for above. Makes antenna unidirectional. Complete. Shpg. wt. 3 lbs.
C22025—Your Cost..... \$2.94

(F) Matching transformer to use FM ant. on either FM or AM without switching. Automatically matches either band to antenna. Shpg. wt. 1 1/2 lbs.
C5968—Your Cost..... \$1.91

Antenna Loops

(G) Ideal for battery and midget sets or portables. Replaces antenna coil; gives satisfactory pickup and excellent selectivity. Inductance slightly higher than necessary, permitting removal of turns for adjustment. 4 3/4"x8".
C16450—Your Cost..... 48¢
Lots of 10..... \$3.95

ICA Tenna-Scope

(H) A new style built-in tuned radio antenna which may be connected to any radio without making any circuit changes. It eliminates the use of an outside aerial and ground. Here is the opportunity for dealers and servicemen to cash in on the newest aerial invention. Some of the features of this unit are: Better selectivity, no aerial necessary, no ground necessary and higher signal to noise ratio.
C16452—Your Cost..... \$1.76

CONCORD Low Cost Aerial Kit

(J) No finer low cost aerial has ever been offered. Complete in every detail and containing only the finest components to provide the ultimate in reception. This kit includes: 50 ft. 7 24 aerial wire, 50 ft. No. 20 insulated lead-in, 25 ft. ground wire, approved arrester, ground clamp, lead-in strip, two porcelain insulators, two nail-it knobs. Can be used with all types of broadcast and all-wave receivers.
C16476—Your Cost..... \$1.09

ECONOMY AERIAL KIT

Contents: 90 feet 7 27 stranded aerial wire, 25 ft. rubber covered lead-in, lead-in strip, ground clamp, 2 nail-it knobs and 2 porcelain insulators. Shpg. wt. 2 lbs.
C16748—Your Cost..... 69¢

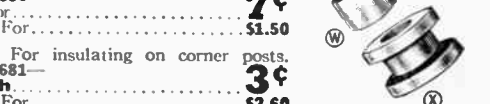
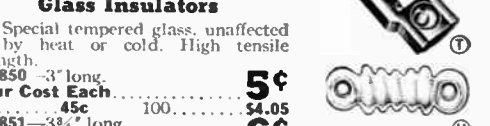
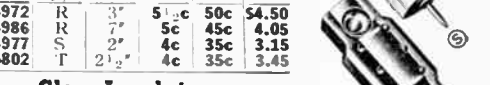
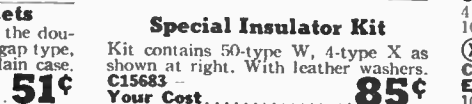
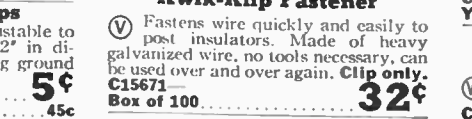
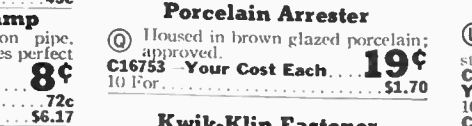
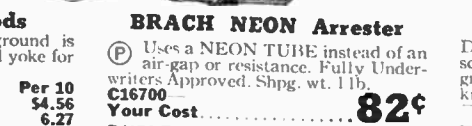
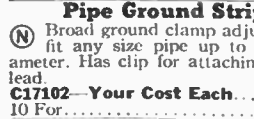
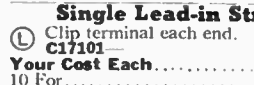
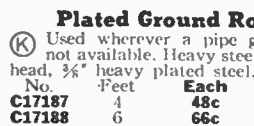
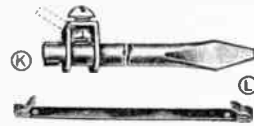

FM and AM ANTENNAS

WARD FM and Television Antennas

Ⓓ Provides an antenna for varying requirements of each FM or television installation, insuring finest reception. Each antenna kit includes sixty feet of 300 ohm polyethylene insulated transmission line. 3 low loss rubber standoffs to guide transmission line down mast, and six low loss plastic stand-offs to guide line to receiver—thus minimizing capacity to ground. Ring for attachment of guy wires assures secure installation. Universal base for mounting on any roof or wall angle. Vertical element revolves or tilts in base for maximum signal pick-up. Dipole of aluminum, all other parts weatherproofed. FM antenna for 88 to 106 mc. range. Television antennas from 41 to 88 mc. range. FM Straight Dipole.

C22027—Your Cost \$5.29

C22028—Television straight Dipole. Your Cost \$6.09

Folded Dipole Antenna

Ⓔ Folded dipole is especially designed for broader antenna tuning and matched impedance to 300 ohm transmission line for maximum response and energy. Less reflector.

C22029—FM Antenna \$6.03

C22030—Television Antenna. Your Cost \$7.06

Mast Extension

Sixty-inch weatherproofed extension to increase height of vertical mast on both FM and Television antennas.

C22031—Your Cost \$1.53

Reflector Kits

Wards reflector kit combined with straight or folded dipoles provide maximum directional gain of desired signal and eliminates undesirable and interfering reflections. Kit consists of sturdy weatherproof cross member with reflector dipole and specially designed "polarizer" connection for mounting. Dipole elements can be rotated in any direction and tilted at any angle to easily orient for highest gain.

C22032—FM reflector kit. \$3.09

C22033—Television reflector kit. Your Cost \$3.79

BELDEN FM Antennas

Ⓕ Belden FM Dipole antenna system is scientifically engineered and may be used on all FM radios, can also be used for standard broadcast reception. Careful electrical design gives excellent response, maximum signal and trouble free reception over entire FM band. Kit contains 65 ft. 300 ohm line and all necessary parts for installation.

C22034—Your Cost \$4.83

BELDEN FM Reflector

Belden FM reflector when used with the above dipole antenna forms an antenna reflector array which improves FM reception on any installation. It is a necessary part of antenna when distance from station is great or location among buildings causes weak reception. Kit consists of aluminum reflector element and cross member, porcelain junction block and complete instructions.

C22035—Your Cost \$1.89

300 Ohm Twin Lead-In

Ⓖ Special low-loss 300 ohm transmission line. Ideal for use with FM and Television antenna kits. Water, acid, alkali and oil proof.

C17130—Your Cost . . . per ft. 3c Per 100 ft. \$2.85

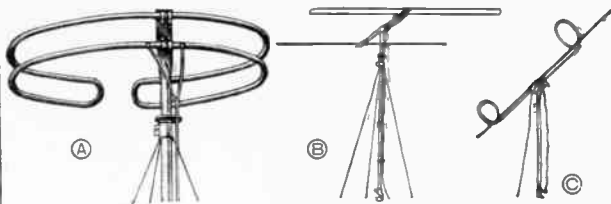

RELIANCE FM Antennas

Antennas are of all metal weather-proof construction and provide maximum electrical efficiency. Each antenna complete with 60 ft. of 300 ohm line, rubber stand-off pads, six low loss plastic stand-off insulators to minimize capacity to ground and eliminate reflections on line. Adjustable universal mounting base on 5-ft. mast enables installation on any roof or wall angle, and facilitates orienting. Complete instructions for installation included with each antenna.

Circular Folded Dipole Antenna

Ⓐ Newly designed circular folded dipole antenna, is non-directional, simplifying its installation, reorientation unnecessary for new station reception. For use fairly close to transmitter. Adaptable for window sill or frame mounting.

\$5.25

Flat Folded Dipole Antenna

Ⓑ Not completely non-directional, may easily be oriented for maximum gain. Provides broad tuning and good pick up. Does not include reflector.

\$4.60

Folded Dipole with Reflector

Ⓑ Provides additional signal strength where installations are remote or where signal output from transmitter is weak. Also eliminates interfering reflections from high buildings and hills. Antenna is directional but completely adjustable to facilitate mounting and orienting.

\$6.50

Additional 5-ft. mast extension for use with above antenna.

1.30

C22013—Your Cost

TRICRAFT Television & FM Antenna

Ⓒ Model 300 was designed to satisfy the users of both television and FM receivers for an all-purpose, all-wave antenna. Provides for complete coverage of both television bands, as well as the permanent FM band. Complete with 65 feet of 300-ohm transmission line and all accessories are necessary for installation. Universal mounting bracket at base of 8-ft. mast is adjustable for mounting on any roof or wall angle.

\$11.61

C22036—Your Cost

FM Dipole Antenna Kits

FM receivers perform to their maximum efficiency when equipped with the Amphendol Dipole Antenna and Reflector combination plus a low-loss 300 ohm Twin-Lead transmission line. This complete beam type of antenna provides high gain. Made of light but superior strength tubular steel. Streamlined, rugged and weather-proof, this assembly will give years of trouble-free service. For 88 to 106 Mc.

C22040—Dipole Antenna and Reflector Kit, less 300 ohm twin lead-in. \$6.91

Your Cost \$4.12

C22041—Dipole Antenna Kit, less reflector and 300 ohm twin lead-in. \$4.12

Your Cost \$3.23

C22043—Side mounting bracket. \$1.88

Your Cost

AMPHENOL Stand-off Insulators

Ⓗ For twin-lead transmission line. Polyethylene insert fits all types of receiving twin leads. Insulators do not have to be strung on line. No. 14 wood screw 3 inches long.

C16957—Your Cost 9¢

Ⓙ Low loss polystyrene insulator for use with 300 ohm, twin lead. Holds line securely but will not pinch and change impedance.

C16958—Your Cost 9¢

WARD Stand-off Insulators

Ⓚ Unique plastic design, holds transmission line firm but cannot pinch line to change impedance.

C16956—Your Cost 9¢

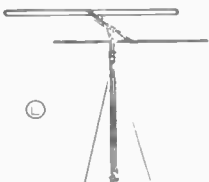

Dipole and Reflector



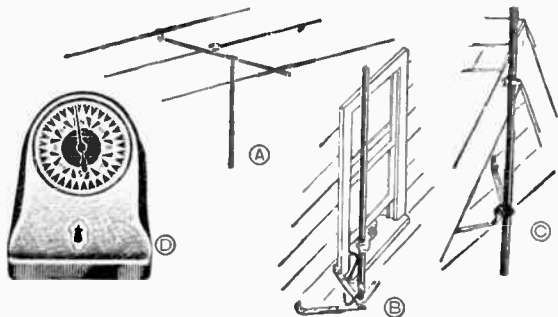

WORKSHOP ASSOCIATES

Broad-Band Ham Antennas and Accessories

10-Meter 3-Element Beam

(A) Horizontal elements made of adjustable telescoping aluminum alloy sleeves. Spacing between elements also adjustable. Designed for strength and durability to withstand high winds and ice. Exceptional rigidity provides smooth easy rotation. Director, dipole, reflector, very unidirectional. Impedance 68 ohms at the feed point inside the weatherproof plastic head. With 72 ohm coaxial cable, standing wave ratio never exceeds 1.3 from 28.0 to 29.7 mc. Comes complete with all beam parts, plugs, gaskets, but less mast and mast parts.

C22014 Workshop No. 29. Your Cost..... **\$39.50**

6-Meter 3-Element Beam

(Not illustrated.) High gain, 3 horizontal elements, high front-to-back ratio. Standing wave ratio less than 1.1 over entire band using 72 ohm cable. Aluminum alloy elements fit securely into a heavy-duty plastic head. With all necessary bolts, connector assembly, and fittings, less mast.

C22016 Workshop No. 52AB. Your Cost..... **\$9.00**

2-Meter 6-Element Beam

(Not illustrated.) Power gain of 6 (7.8 db). Six vertical elements of 1 1/2" aluminum tubing sealed at the ends, dipole, two directors, and two reflectors, all phased to give a very high front-to-back ratio and very narrow forward direction. For 50-ohm coaxial line. Rugged and rigid. Complete, less mast and mast parts.

C22015 Workshop No. 146AB. Your Cost..... **\$21.50**

Manual Mast Rotator

(B) By adding the extra sections and brackets in the manual rotator kit, the above listed mast can be turned from below. A rotating arm is supplied to attach to the lower end for locking the antenna in position. Complete kit.

C22019 Workshop No. AM2. Your Cost..... **\$5.00**

Mast and Mount

(C) Rugged tubular steel mast in two 4-ft. sections to make overall length of 7 1/2 ft. Strong adjustable steel mounting arms eliminate guy wires. Adjust to the side of any structure by shortening or lengthening the mounting arms. Complete kit, contains all bolts and brackets.

C22017 Workshop No. AM. Your Cost..... **\$8.25**

Workshop No. AM1, Extra 4-ft. mast sections to heighten above mast.

C22018 Your Cost Each..... **\$1.30**

WORKSHOP Remote Rotator

(D) Sturdy smooth-operating mechanism. Years of trouble-free service. Will accommodate a 10- and 20-Meter combination beam or any one array. Unbroken coaxial line feed made possible by automatic North stop. Full rotation at 1 rpm, reverses instantly from any point. Single switch on indicator controls rotation. Compass-dial pointer shows beam direction at all times. Sturdy base plate mounted on ball thrust bearing handles 500-lb. load with ease. Heavy duty 110v AC motor with high gear ratio. Precision-cut gears minimize backlash and wear, maintain high accuracy. Compass dial indicator housed in attractive black enameled aluminum case, rotator housed in weather-tight aluminum casting 9x9x6"; weight 27 lbs.

C22020 Your Cost..... **\$157.50**

GORDON ROTO-BEAM

(H) Dual selsyn and drive motor system to rotate antenna remotely. Station control (J illustrated) contains selsyn-driven azimuth dial which follows antenna, On-Off master switch, and rotation control switch with 3 positions: CCW (counterclockwise), Off, and CW (clockwise). Antenna station is weather sealed and designed for easy mounting both of itself and of antenna arrays. Drive motor develops 43,200 inch ounces at the spider through the 1800:1 gears. Antenna speed is 3/4 rpm. Direct RF coupling through slip rings and inductive coupling through rings 1/2" apart permit dual band operation at up to 5 KW. For 115 volt, 60 cy. AC operation. Both stations.

C22026 Your Cost..... **\$225.00**

AMATEUR ANTENNAS

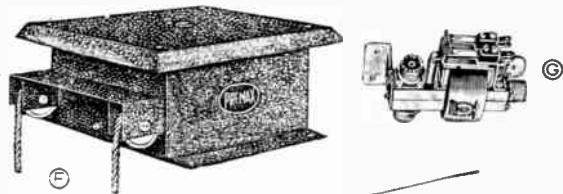

PREMAX Rotary Beam Kit

(E) A high-gain directive 3-element array using a single frame and adjustable seamless duraluminum tubing to cover the 6, 10, or 11 meter bands. Angle iron supporting frame is provided with mounting holes and hardware for easy one-man assembly. All metal, no warping or cracking. Insulation at voltage nodes to reduce leakage losses. "T-match" feed and 300 ohm line usually used, but removable shorting plates permit other feed systems as well as facilitate tuning. Kit includes frame and 3 pairs of elements with necessary insulators and hardware, including T-match accessories. Shpg. wt. 30 lbs.

C22021 Premax No. RB-6309. Your Cost..... **\$29.40**

Extra elements only, in pairs. Shpg. wt. per pair 2 lbs.

C22022 Premax No. 309-A. Your Cost per Pair..... **5.29**

PREMAX ROTOMOUNT

(F) Hand operated turntable will support largest beam assembly. Turned manually with flexible steel cable and pulleys on the same principle used to steer boats. Inexpensive but practical and easy operating. Full 360° rotation in either direction. 7" diameter ball thrust bearing. Shaft supported by 2 side bearings to eliminate side-play. Supplied with 6 ft. of galvanized flexible steel cable. Platform 10x12". Shpg. wt. 17 lbs.

C22023 Premax No. BM-16. Your Cost..... **\$21.46**

MILLEN Antenna Matching Preamplifier

Impedance matcher and broad-band preamplifier. 20, 10 and 6 meter bands. Tunes antenna to receiver and amplifies signal with 6AK5 for total gain up to 60 db. Plug-in coils fit into front panel. Gets 180 v DC at 10 ma and 6.3 v AC at 175 ma from receiver. Complete with plug-in for 27-32 mc, power cable, input and output connectors, less tube. 6 1/2 x 5 1/2 x 4 1/2". Shpg. wt. 3 lbs.

C21015 MilLEN No. 92101. Your Cost..... **\$24.75**

C21016 Plug-in assembly for 48-55 mc. Your Cost..... **\$3.15**

C21017 Plug-in assembly for 13-15 mc. Your Cost..... **3.15**

GORDON Heavy Duty RF Relay

DPTDT, for antenna changeover or tank switching. Handles 150 W easily. Alsimag 196 insulation, PF .03, negligible loss, even above 100 mc. 3/8" coin silver self wiping contacts go together with no chatter or bounce. 110 V 60 cy. coil holds contacts together with 4 lb. pull. 1/2" contact spacing when open, no flash-overs. 4 1/4 x 5 1/2 x 3 1/2".

C14135 Gordon No. 1000. Your Cost..... **\$10.58**

Coaxial Antenna Transfer Relay

(G) SPDT, capacity 750 watts RF if impedances are matched. Has three SO-239 female receptacles to accommodate plugs on RG-8/U cables to antenna, transmitter and receiver. Coil is for 110 V, 60 cy.

C14133 Price No. 6350. Your Cost..... **\$9.80**

Type 6351, same as above with the addition of two sets of auxiliary contacts, one SPST normally open and one SPST normally closed, both rated at 250 ma, 300 V DC. Use for ECO and receiver switching. Overall dimensions with auxiliary contacts are 4 1/2 x 3 x 2".

C14134 Your Cost..... **\$10.78**

Direction Indicator Potentiometer

Simplest azimuth indicating system. Pot designed for continuous rotation is put in series with a 200 ohm, 1/2 W resistor and an On-Off SPST switch across 6 v DC. Beam is mounted directly to arm of pot. An 0.1 ma DC meter is connected to the pot arm through a 6000 ohm rheostat. Antenna is oriented so beam points South when pot arm picks off maximum voltage, and rheostat is adjusted so meter reads full scale (1 ma). As beam is turned through 359°, meter drops to zero. The next 1° swings the meter back to 1 ma. Both 0 and 1 ma are therefore S, 1/2 ma is E, 1/4 ma is N, and 1/4 ma is W. Meter scale may be marked as above. Potentiometer only. Ohmite RB-2.

C8393 Your Cost..... **\$4.78**

ALL-PURPOSE RELAYS

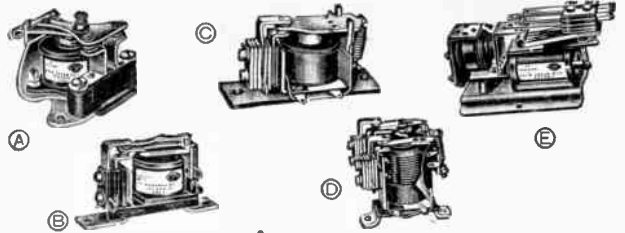
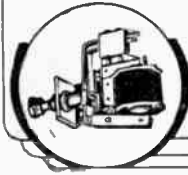

POTTER-BRUMFIELD Relays

Type "PR"

(A) A series of heavy-duty power relays designed for starting motors up to 1 HP, high heater loads, or any power control circuit requiring fast positive switching. Cont. duty with no overheating because coils take only 2 watts (DC models) and 5 VA (AC models).

Larger copper shaded pole piece prevents AC chatter. Heavy contact pressure. Sturdy return spring. Metal parts heavily plated. Coils thoroughly impregnated with varnish and baked. Rugged screw terminals. Contacts are 3/8" oval-shaped coin silver. Ratings given below are conservative. Double-break types carry 20 amperes non-inductive load at 110V, AC or 10 amps. 110V, DC, or 1 HP 110 or 220V, single-phase motor. Single break types carry non-inductive loads of 15 amps. 110V, AC, 8 amps, 110V, DC or 220V, AC. Size: 2 3/4" long, 2 3/8" wide, 2" high. Shipping weight 2 lbs. each.

No.	Type	Contacts	Coil Vlt.s.	Each
C14254	PR3A	SPST-DB-NO*	6V 60c AC	\$2.80
C14255	PR3A	SPST-DB-NO*	110/60c AC	2.80
C14256	PR4A	SPST-DB-NC*	6V/60c AC	2.90
C14257	PR4A	SPST-DB-NC*	110/60c AC	2.90
C14258	PR5A	SPDT	6V/60c AC	3.10
C14262	PR5A	SPDT	110/60c AC	3.10
C14263	PR7A	DPST-NO	6V/60c AC	3.60
C14264	PR7A	DPST-NO	110/60c AC	3.60
C14244	PR11A	DPDT	6V/60c AC	4.60
C14245	PR11A	DPDT	110/60c AC	4.60
C14265	PR3D	SPST-DB-NO*	6V/DC	2.80
C14266	PR3D	SPST-DB-NO*	24V/DC	2.80
C14267	PR4D	SPST-DB-NC*	6V/DC	2.90
C14268	PR4D	SPST-DB-NC*	24V/DC	2.90
C14269	PR5D	SPDT	6V/DC	3.10
C14270	PR5D	SPDT	24V/DC	3.10

*NO—normally open. *NC—normally closed.

"MR" Series

(B) A more compact relay for lighter loads than the "PR" series. Will handle 8 amps. AC or 4 amps. DC non-inductive loads. Adjustable spring. No current carried through spring. 2 3/8" L., 1 3/8" W., 1 3/8" H. AC coils require approx. 2 watts; DC approx. 1 1/2 watts.

No.	Type	Contacts	Coil Vlt.s.	Each
C14271	MR5A	SPDT	6V/60c AC	\$1.86
C14272	MR5A	SPDT	110V/60c AC	1.86
C14273	MR11A	DPDT	6V/60c AC	2.66
C14274	MR11A	DPDT	110V/60c AC	2.66
C14275	MR5D	SPDT	6V/DC	1.86
C14276	MR5D	SPDT	21V/DC	1.86
C14277	MR11D	DPDT	6V/DC	2.66
C14278	MR11D	DPDT	21V/DC	2.66

Plate Circuit Relays

(C) Armature spring adjustable for applications requiring closing or opening on specified currents or voltages. Table below shows standard factory adjustments for current to energize, also minimum after readjustment of spring. Residual screw is adjustable for faster release when de-energized. LM5, LM11 (C) contacts rated conservatively at 5 amps, LS5 (D) at 4 amps. Illustration (C) for the LS series. Illustration (D) for the LM series. LM's are 2 1/4" L., 2 3/8" H., 1 3/8" W., wt. 1 oz. LS is 2 3/8" L., 1 3/8" H., 1 3/8" W., wt. 2 1/2 oz.

Stock No.	Mfr's No.	Coil Ohms	Current Min.	Current Std.	Your Cost
C14279	LS5*	2,500	6.0	9.0	\$1.68
C14281	LS5*	5,000	4.3	6.3	1.99
C14209	LM5*	2,500	2.4	6.3	2.05
C14210	LM5*	5,000	1.7	4.5	2.30
C14211	LM5*	10,000	1.2	3.2	2.65
C14212	LM11†	2,500	5.3	9.0	3.05
C14213	LM11†	5,000	3.7	6.3	3.30
C14214	LM11†	10,000	2.7	4.5	3.65

*SPDT Contacts.

†DPDT Contacts.

Photoflash Relays

(E) Energizing coils, available for both 6 volts AC and 2 volts DC. New alloy contacts discharge capacitor through arc lamp, handle hundreds of amps during flash. 2500-volt insulation. Varnish impregnation prevents moisture absorption.

Stock No.	Mfr's No.	Coil	Contacts	Your Cost
C14150	FR1A	6vac	SPST, NO	\$2.78
C14151	FR5A	6vac	SPDT	2.96
C14152	FR11A	6vac	DPDT	4.01
C14153	FR1D	2vdc	SPST, NO	2.78
C14154	FR5D	2vdc	SPDT	2.96
C14155	FR11D	2vdc	DPDT	4.01

Automatic Lock Relay Electrical Release

(E) Employs two coils—one to operate relay and another to release the lock. When the circuit to the operating coil is closed momentarily the normally closed contacts open and the normally open ones are closed with the relay remaining in this position even with the current removed from the coil. In order to return the contact positions to normal, current is applied to the "release" coil which removes the automatic lock and allows the relay to return to its original position. 3/8" fine silver dome-shaped contacts rated conservatively at 4A; less conservative rating is 20 A. 3 1/4" L., 2 1/4" H., 1 3/4" W. Shpg. wt. 2 lbs.

C14142—EL11A.	DPDT contacts, 110 V. 60 cycle AC coils.	\$3.90
Your Cost		
C14143—EL5A.	Same as above but SPDT contacts.	
Your Cost		\$3.39

WARD-LEONARD Relays

Standard-Antenna Change-over



(F) Mycalex base and cross-arm. Coil consumption 3 to 4 watts at 110, 120 V., 50/60 cycles AC. Wiping make and break silver-to-silver contacts. Base 2 7/8 x 2 7/8". Double-pole double-throw, single break. Shipping weight 1 lb.

C14148 Type 507-531. Each \$5.60

With Break-in (No. 507-534)

Same as above but with two additional single poles. One normally closed, the other normally open. Base: 3 3/8 x 2 7/8". Shipping weight 1 lb.

C14131—Your Cost \$7.69

Remote Control Heavy Duty Midget

(G) Single-Pole double-throw, single break. 110 V. AC operation. Silver-to-silver self-cleaning contacts. Rating: 20 amps. AC normally open, 15 amps. AC normally closed. Size: 2 3/8 x 1 3/4". Shipping weight 1 lb.

Type 507-519. C14124—Your Cost \$3.50

Thermal Time-Delay Relay

(H) For rectifier tube protection. Single-pole double-throw, single break. Timing adjustable from 15 to 45 sec. 4 amp. contacts. Dust-proof cover. 110/120 V., 50/60 cycle, 1 1/2 x 1 3/8".

C14129—Your Cost \$10.50

AMPERITE Thermal Delay

(J) SPST, normally open, closed by heater after delay (in seconds) per table below. In standard octal tube envelope. Heaters 6.3 V., approx. 0.4 A., or 115 V., approx. 2 1/2 W. Contacts rated 115 V., 3 A. AC, but can handle DC if shunted with capacitor.

Delay	6.3V Heater	115V Heater	Your Cost
15	C14400	C14405	\$2.10 Each
5	C14401	C14406	
30	C14402	C14407	
75	C14403	C14408	
120	C14404	C14409	

GUARDIAN Relays

Keying Relay

SPST Normally Open Double Break

(K) Special oversize silver contact points control transmitters using filament center-tap keying of any stage up to 2KV on plate; or using AC primary keying control of power supplies delivering up to and including 1 KW; or using grid-controlled rectifier keying of 3 KV power supplies. Insulation is high-test bakelite, will withstand 3KV to ground. May be mounted in any type of panel. All terminals are insulated from ground. Coil takes 920 ma at 6.3 V AC. Relay will follow key or bug at highest WPM rate obtainable. High response speed, very strong magnet and return speed, give clean make and break, producing the best CW tone. Guardian Series K-320, 3 1/2 x 1 1/2 x 1 1/8". Shpg. wt. 4 oz.

C14119—Your Cost \$2.47

Adj. Overload with Elect. Reset

(L) Positive precise protection against current surges or continuous overloads. Remote panel installation of the control potentiometer (shunted across the coil as a current divider) simplifies adjustment of relay to operate on any current value from 250 to 750 ma. Auxiliary contacts for pilot-light indication of "overload" or "clear." Reset relay uses 6.3 V AC coil, draws 920 ma, can be operated from any convenient point. Voltage drop across coil and pot. is less than 10 volts at any current value. Insulation between coil and ground rated at 3KV. Guardian Series X-300-ER, 1 3/4 x 1 1/8 x 2". Wt. 13 oz.

C14120—Your Cost \$4.85

Antenna and High Frequency Relays

Low capacity oversize silver contacts handle 1 KW in AF or RF circuits at frequencies up to 28 MC. Alsmag insulation; 110 volt AC coils.

C14118	-Model R-100 SPST, Normally Open.	Your Cost	\$2.08
C14115	-Model R-100-B SPST, Normally Closed.	Your Cost	2.08
C14117	-Model R100G DPDT.	Your Cost	4.49

Break-In Relay

Specifically designed for break-in operation of transmitters. 1/4" fine silver contact points handle 1500 watts non-inductive or 1000 watts inductive 60 cycle AC. Two sets of SPST contacts, 110 volt 60 cycle coil.

C14125—Model B-100. Your Cost \$5.64

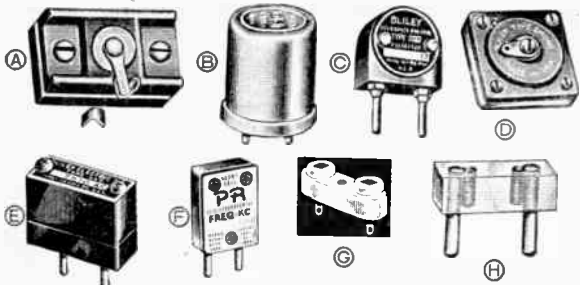

BLILEY Crystals

- (A) CF6 single signal filter crystal unit. Low holder capacity permits sharp signal discrimination in filter networks. Frequency 455 kc. free of spurious responses within ± 7 kc.
- C13854—Your Cost** \$4.50
- (B) KV3 precision 100 kc. crystal unit for use as frequency standard. Mounts in octal socket, will operate in any position. Comes with schematic of recommended oscillator.
- C13853—Your Cost** \$6.95
- (C) CF3 single signal filter crystal for IF filter. Frequency 455 kc. ± 5 kc. free of spurious responses ± 7 kc.
- C13855—Your Cost** \$5.00
- (D) SMC 100 dual frequency crystal provides either 100 kc or 1000 kc source. 1000 kc $\pm .05\%$, 100 kc can be adjusted to zero beat. For alignment of receivers.
- C13856—Your Cost** \$8.75
- (E) Ax2 crystal accurate to $\pm .002\%$ at 25° C of nameplate frequency. Two units can be mounted in octal socket. Molded phenolic case $1\frac{1}{8}$ " W. x $1\frac{1}{8}$ " H. x $1\frac{1}{8}$ " thick.
- C13851—** 3500—4000 KC ± 5 KC specified frequency.
- C13850—** 7000—8222 KC ± 5 KC specified frequency.
- C13852—** 14000—19870 KC ± 30 KC specified frequency.
- Your Cost** **\$2.80**

PR Crystals

- (F) Temp. coefficient less than 2 cycles/mc/degree C., accuracy of calibration within 1%. Mounts in octal socket. Heavy drive without crystal damage.

No.	Type	Freq. Range	Price
C13860	Z2	3.5 to 4.0 MC	\$2.65
C13861	Z2	7.0 to 7.5 MC	2.65
C13862	Z3	14.0 to 14.8 MC	3.50
C13863	Z5	28.0 to 31.0 MC	5.00

Crystal Sockets

- (G) Available in low loss Poly-styrene or Steatite, mounts, above or below chassis, soldered lug terminals.

No.	Make	Insulation	No.	Make	Insulation
C8050	Milten	Steatite	*C8051	Milten	Steatite

Your Cost 25c
Your Cost 25c
Your Cost 22c

Crystal Holder Adaptor

- (H) Adapts new octal crystal holders to 5 prong mountings. Plastic with copper contacts and prongs.
- C8054—Your Cost** **34¢**

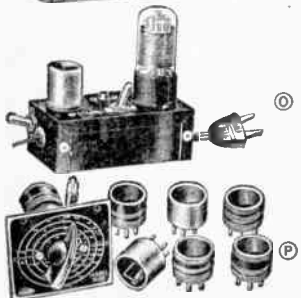
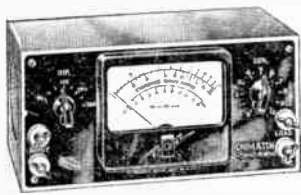

Micromatch SWR and RF Wattmeter

- (M) Model 908 MicroMatch connected in your transmission line will instantly reveal standing wave ratio, percentage of power wasted, and through adjustment of your antenna tuner, let you put 90% or more of your transmitter power into the antenna—raise your "S" reports. Reverse the connections and after a simple calibration, it will read your power output, be it 1 or 1000 watts, or anything in between. Impedance range 50 to 300 ohms, 3 thru 30 MC.

Easily read, large, open-scale 4 1/2" meter. Attractive appearance and small size add almost as much to station appearance as the vital measurements add to your DX, frequency flexibility and cutting down of BCL. Factory wired and tested. In gray enamel steel cabinet with etched white on-gunmetal aluminum panel. Size: 10x5x5 1/2". Shpg. wt. 8 lbs.

C21539—Your Cost **\$29.90**

BUD VFO

- (N) Model VFO-21 Variable Frequency Oscillator uses 6F6 oscillator, 6V6 amplifier, VR 105 voltage regulator, NE51 tuning indicator and 5Y3GT/G rectifier. Uses plug-in coils for highest efficiency. Power output 4.5 watts. Built in power supply incorporates voltage regulator tube that makes output stability comparable to crystal oscillator. Has provisions for switching to crystal operation. Keyed in screen grid 115 VAC 60 cyc. operation. Complete with tubes and three 40-meter coils. In Grey wrinkle finish cabinet. Size: 12 1/2"x8 1/2"x8". Shpg. wt. 17 lbs.
- C21009—Your Cost** **\$51.45**
- C9959—** Set of 10 Meter coils \$3.92
- C9960—** Set of 20 Meter coils 3.92
- C9961—** Set of 80 Meter coils 3.92

AMATEUR FREQUENCY CONTROL EQUIPMENT

HAMMARLUND FS-135-C Frequency Standard

- (J) With this unit, your receiver becomes an accurate frequency meter. Special 100 kc crystal generates marker signals every 100 kc over range of receiver. By adjusting crystal frequency to zero beat with WWV, receiver can be calibrated to accuracy of costly frequency standard. Small size permits mounting in any receiver. Requires 6.3 VAC at 3 amps.; 150-250 VDC at 2 ma. Complete with crystal, tube, and instructions. Size: 2"x2"x3 3/8". 2 mtg. holes on 2 3/4" mtg. ctrs.
- C8735—Your Cost** **\$14.25**

BUD Gimix Wavemeter

- (K) Designed to give amateurs and experimenters a dependable general utility meter. Absorption type wave meter covering the 80, 40, 20, 15 and 10 meter bands. Phone jack allows use as monitor for phone operation. Divided in two groups, one of 80 and 40, and the other of 20, 15 and 10 selected by switch. When link coupled to a small pickup antenna unit acts as held strength meter for tuning antenna. Can also be used as neutralization indicator and by plugging a milliammeter into meter jack unit becomes a carrier shift indicator for use in pre-tuning or normal transmitter operation. Size: 6"x2"x2 3/4" requires no batteries or external connections.
- C21008—Your Cost** **\$8.13**

TRIPLETT Absorption Frequency Meter

- (L) For checking frequency, harmonics, parasitic oscillations, standing wave ratio and neutralization. A band switching, tuned absorption-type frequency meter covering five amateur bands. Incorporates germanium crystal and DC milliammeter indicator for greater sensitivity. Direct calibration on panel, no coil to change, switching permits instantaneous band change. Audio jack for monitoring of phone signals. Fully shielded. Calibration is in megacycles in the following bands: 3.5-4, 7.7-3, 14-4.4, 20-21.5, 28-30. Coil is removable and other coils may be substituted for special bands. 7 1/2" high, including coil; 2 1/2" wide, 2 1/4" deep. Gray hammered enamel finish with black trim. Shpg. wt. 5 lbs.

C21479—Your Cost **\$14.45**

BUD Frequency Calibrator

- (O) New frequency calibrator has 100kc. crystal, usable harmonics up to 30 mc. Has on-off standby switch, thereby permitting FCC-90. Adjustment for zero beating WWV. Self contained power supply.
- C21014—Your Cost** **\$14.65**

SILVER 903 Absorption Wavemeter

- (P) Frequency range 1600 Kcs. to 400/500 mc. ranges. Consists of etched aluminum panel carrying 600 series low loss Steatite insulated tuning capacitor, inductor socket, resonance-indicating lamp and socket. Frequency range made possible by two types of tuned circuits. On six ranges plug in inductor is paralleled with tuning capacitor, seventh 400/500 mc. range plug in inductor is quarter wave transmission line with series tuning. Size: 3 1/2" sq., 3 3/4" deep. Unit less plug in inductors.

C21291—Your Cost **\$3.30**

Plug in inductors with built-in indicator lamp coupling coil.

- C21292—** Range 1600/3700 kc.
- C21293—** Range 3500/8000 kc.
- C21294—** Range 8000/15000 kc.
- C21295—** Range 17/40 mc.
- C21296—** Range 40/100 mc.
- C21297—** Range 100/300 mc.
- C21298—** Plug in quarter wave transmission line. Range 400/500 mc. No indicator lamp coupling coil.

Your Cost, any type **65¢**

NOTE: We carry a comprehensive line of amateur radio equipment. If you do not see what you want on these pages, write us your requirements. Your inquiries will receive our prompt attention.

Meissner-Carron Stanwyck COILS

MEISSNER "Plastic" I.F. Coils Stable—Compact—Wide Range

A new transformer in which the trimmer base and the coil form (dowel) are moulded in one piece. The use of a special plastic material permits holding dimensions to within .0005". Trimmers "floated" away from the base with an air-gap between the bottom plate and plastic base. Wide range. Compact in size; 1 1/2" square by 2 1/2" high. Special-served Litz wire. Double tuned. Metal shield can. Unaffected by temperature or humidity. Suitable for Input and Output.



Stk. No.	Meissner No.	Set at Kc.	Range KC	Each
C10373	16-6649	175	140-200	} 81¢
C10376	16-6652	262	200-310	
C10379	16-6655	370	305-480	
C10382	16-6658	456	400-550	

IF Transformer



For the new ultra high F.M. frequencies. Permeability tuned to 10.7 megacycles. Mounted in rectangular shield can measuring 1 1/8" x 7/8" x 1 1/2" with screw type mounting lugs.

C10329—Meissner 16-6665
Your Cost Each.....\$2.20

Discriminator X'former

Permeability tuned to 10.7 megacycles. This discriminator is designed for use on the new FM range. Same size as above.

C10333—Meissner 17-3484
Your Cost Each.....\$2.94

MEISSNER Standard Antenna and R.F. Coils

Designed to cover the Broadcast band from 545 to 1580 KC (190-550 meters) with a 365 mmfd tuning condenser. High impedance primaries, wound with Litz wire. Shielded coils are in black crackle finished non-magnetic can. 1 1/2" diam. x 2 1/2" high.

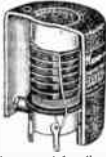

Shielded
C10044—Ant. Coil.....**73¢**
C10045—RF Coil.....

Unshielded
C10046—Ant. Coil.....**57¢**
C10047—RF Coil.....

Phono Osc. Coil

For wireless record players. Knob adjustment permits selection of frequency in broadcast band. 1 1/2" square by 3 1/2" high.

C10010—Meissner 17-9373.
Your Cost Each.....\$1.64

B. F. O. COIL

For use with superhet receivers to supply beat note necessary for CW reception. Range, 290-650 KC; peaked at 456 KC. Knob adjustment. 1 1/2" sq. x 3 1/2" high.

C10171—Meissner 17-6753.
Your Cost Each.....\$1.44

Special Oscillator Coil For Type 6SA7

For electron coupled oscillator circuits. Unshielded, 456 KC IF. Requires 350 mmfd. padding cond. 365 mmfd. tuning condenser.

C10332—Meissner 14-1033.
Your Cost Each.....62¢

Ferrocart (Iron Core) IF Transformers

Double-tuned I.F.'s with low-loss trimmers. Accurately made of the best materials and oscilloscope-tested for gain and selectivity. Mounted in 1 1/4" square by 3 1/2" high black crackle-finished cans. Leads are RMA-color-coded.



Input	Output	Set at Range	Range KC
C9689	C9687	456	360-600

Your Cost Each.....\$1.64

"Universal-Adjustable" Iron Core Ant., R.F. and Osc. Coils

Will replace broadcast band coils in practically any receiver. Will accurately track with other coils in the receiver when properly adjusted. Exact inductance of burned out coil easily matched with screw driver adjustment of the iron core. Will improve gain and selectivity. Oscillator coil can be adjusted from 175 to 520 kc. and used with either cut plate or padding condenser circuits.



Stock No.	Type	Each
C10007	Antenna	} \$1.02
C10008	RF	
C10009	Oscillator	

Oscillator Coils
For 190 to 550 meter broadcast band. Used with .000365 mfd. condensers. Shielded type is 1 1/4" H. 1 1/2" D. Used with I.F. xfmrs. and r.f. and antenna coils. Padders not supplied.



No.	Freq.	Padder	No. Unshielded	K.C. Mmfd.	shielded
C10029	175	900	C10028		
C10031	456	350	C10030		

Your Cost—Shielded.....78¢
Your Cost—Unshielded.....62¢

STANWYCK Midget IF

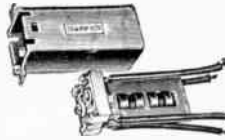

Standard iron core 455 kc. midgets. Compression tuned, exceptionally high gain due to specially designed powdered iron cores. For general replacement and new set construction of small receivers and portables. Dimensions of can 3/4" square by 1 1/8" long.

C10350—**Your Cost.....97¢**

Unshielded Universal Adjustable Coils



Exact inductance of replaced coil covering 550-1715 KC matched easily. Oscillator coil adjustable from 175 to 520 kc. Have universal mounting facilities and can be mounted in original shield or used as is. Inductance adjusted by slipping core in or out of coil and then set with radio cement.

C10307—Antenna
C10309—R.F.
C10310—Oscillator
Any Type Above, Your Cost, Each.....73¢

CARRON Cartwheel I.F. Transformers



For unshielded operation in midget radios. Not to be used where original was in shield can; not to be placed in a shield. Tunes to 456 KC.

C10145—Input
C10146—Output
Either Above, Each.....79¢

PEE WEE TYPE Antenna and R. F. Coils



Designed for service replacement in miniature sets. Secondaries "progressive" wound with Litz wire on 1/2 x 1 1/2" impregnated forms. High impedance primaries and coupling turns provided to give maximum response thruout. B.C. band covers 540-1500KC with 365 mmfd. condenser. Ear lug mounting also perforated bracket for all mounting methods. Unshielded.

C10315—Antenna.
C10316—R.F.... Each **51¢**

Ultra Midget Coils

Similar to above, but slightly larger in size. Litz wound on impregnated forms 3/8 x 1 1/4", unshielded.

C10313—Antenna
C10314—R.F. Each **40¢**

CARRON Standard I. F. Transformers



Built to highly exacting standards, these double tuned I. F. transformers will assure excellent results. Low loss trimmers. In 1 1/2 x 1 1/2 x 3 1/2" shield can. Spaced leads eliminate "flutter" under vibration. Frequency 456 Kc.

C10147—Input
C10148—Output
Either Above, Ea.... 97¢

CARRON Midget Iron Core & Standard I. F. X'formers

Designed for use with modern tubes. Wound with Litz wire. Ceramic base trimmer; polystyrene impregnated winding forms double tuned. Leads from trimmer spaced away from windings. For use in one or two stage amplifiers. Only 2 1/2 inches high, 1 1/4" square.



Iron Core 456 Kc.
C10204—Input
C10205—Output
Either Above, Ea... \$1.23

Standard 456 Kc.
C10206—Input
C10207—Output
Either Above, Each... 91¢

LITZ WOUND Antenna and R. F. Coils

Employ new type bank winding for practically constant gain and selectivity over B.C. band. High impedance primaries. Tune 540-1500 kc with 356 MMF condenser. Impregnated 3/8 x 2 1/4" tube. Round cans with spaced bolt mtg. on 1 1/4" centers. 1 1/2 x 2 1/4"



Shielded Type
C10317—Antenna
C10318—R.F.... Each **68¢**

Unshielded Type
Univ. bracket; standoff mounting.
C10319—Antenna
C10320—R.F.... Each **50¢**

Oscillator Coil

Use with converter tubes such as the 6SA7. Furnished in dowel wound type for operation with 455/6 Kc. I. F. frequencies only. Padding condenser value, 360-470 mmfd.

C10237—**Your Cost.....50¢**

CARRON Unshielded 456 KC Oscillator Coil

Dowel type, wound with cotton covered enamel wire, thoroughly dehydrated, treated, and flash dipped in a high melting point wax. Color coded for connection values. Padder condenser value: 360-470 mmfd.

C10238—**Your Cost... 50¢**

CARRON R. F. Chokes

All purpose r. f. chokes wound on steatite dowels. Both winding and dowel impregnated, sealed permanently against humidity. Accurately rated. Mounted on "L" bracket, placing lugs in easy connecting position. Excellent replacements.



Stock No.	Inductance in MH.	Your Cost ea.
C10208	2.5	} 29¢
C10209	5.5	
C10210	7.5	
C10211	10.0	40¢
C10212	30.0	44¢
C10213	60.0	51¢

STANWYCK FM IF COILS

Newly designed SLUG TUNED FM coils, maximum "Q" and gain at 10.7 mc. Low loss ceramic and quality iron cores. Response curve symmetrical, extreme stability. Aluminum case 1 1/2" square by 3"

C10351—**Your Cost.....\$1.91**

FM Discriminator

Same as above electrically and mechanically. Electrically centered secondary gives perfect symmetry between peaks. For 10.7 mc.

C10352—**Your Cost.....\$2.15**



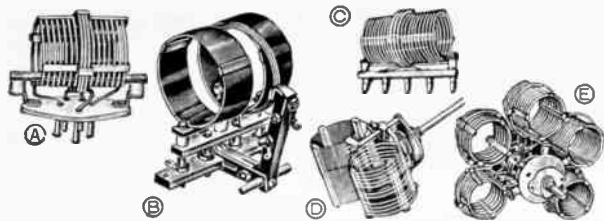

Transmitting COILS · CHOKES

BARKER & WILLIAMSON Junior & Type B Inductors

(A) Juniors for powers up to 75 watts input with plate voltages up to 850. Fitted with standard 5-prong Steatite base. $3\frac{1}{4} \times 1\frac{1}{2} \times 3\frac{1}{4}$ ".

(B) Type B for powers up to 150 watts input with plate voltages up to 1500. Steatite base and plug-in jack mounting. $3\frac{1}{2} \times 2\frac{1}{2} \times 4$ ".

Capacities shown (in mmf) to resonate the L.F. end of the band can actually be 5 to 20 mmf less because of tube and wiring capacities.

Juniors			Type B		
Band Cap.	Stock No.	Your Cost	Cap.	Stock No.	Your Cost
End Linked Models					
5	15	C10460 \$1.38	14	C10479	\$2.41
10	22	C10461 1.38	21	C10480	2.41
15	22	C10462 1.38	21	C10481	2.48
20	34	C10463 1.38	33	C10482	2.48
40	47	C10464 1.38	36	C10483	2.83
80	60	C10465 1.38	36	C10484	3.16
Center Link Models					
5	15	C10466 \$1.38	14	C10485	\$2.41
10	16	C10467 1.38	20	C10486	2.41
15	16	C10468 1.38	21	C10487	2.48
20	16	C10469 1.38	34	C10488	2.48
40	33	C10470 1.38	37	C10489	2.83
80	53	C10471 1.38	39	C10490	3.16
Variable Link Models					
5	15	C10472 \$1.38	15	C10491	\$1.93
10	22	C10473 1.38	14	C10492	1.93
15	27	C10474 1.38	25	C10493	2.00
20	21	C10476 1.38	25	C10494	2.00
40	31	C10477 1.38	29	C10495	2.28
80	46	C10478 1.38	46	C10496	2.61

*With center tap.
Steatite Jack Bar Assembly for end or center link Type B inductors (former type A56).
C10497—Your Cost \$5.00
Jack Bar and Swinging Link for variable link Type B inductors.
C10498—Your Cost \$3.44

B & W Types T and HD

Type T: up to 500 watts input. For most amateur uses. The link for the variable center-linked models is hinged on the jack base and may be arranged for easy panel adjustment. Matches load impedances of 72 ohms. The same link is used with the plug-in coils for all bands. Allow mtg. space $7\frac{1}{2}$ " long x $6\frac{1}{4}$ " high and approx. 5" wide.

(C) Type HD: heavy duty, up to 1000 watts input. Similar in arrangement to Type T. Heavy steatite plug bar and jumbo banana plugs. Allow mtg. space 11×9 " and approx. 7" wide.

Capacities: can be 5 to 20 mmf less than shown because of tube and wiring capacities.

Type T			Type HD		
Band Cap.	Stock No.	Your Cost	Cap.	Stock No.	Your Cost
Center Linked Models, Center-Tapped					
10	19	C10499 \$2.89	20	C10511	\$5.85
15	21	C10500 2.96	20	C10512	6.54
20	21	C10501 2.96	20	C10513	6.54
40	34	C10502 3.30	20	C10514	6.88
80	55	C10503 3.65	31	C10515	7.56
Variable Linked Models, Center-Tapped					
10	17	C10504 2.20	16	C10516	4.48
15	22	C10505 2.28	16	C10517	5.16
20	22	C10506 2.28	18	C10518	5.16
40	29	C10507 2.61	33	C10519	5.50
80	39	C10508 2.96	41	C10520	6.19

Steatite Jack Bar Assembly for center link Type T inductors (old type A54)
C10509—Your Cost \$1.25
Base Assembly and Swinging Link for variable-link Type T inductors.
C10510—Your Cost \$5.50
Jack Bar Assembly for center link Type HD inductors.
C10521—Your Cost \$1.75
Base Assembly and Swinging Link for variable-link Type HD inductors.
C10522—Your Cost \$6.88

B & W Turrets

The successful development of the turret by B & W has made possible fast, positive band switching so much in demand for amateur rigs. By the use of a unique switching assembly, unused coils are shorted, thereby eliminating absorption effects. All models mount in a single $\frac{3}{8}$ " panel hole and cover the 80, 40, 20, 15 and 10 meter bands by shaft rotation.

Band Hoppers

(D) For powers up to 75 watts. Uses same coil design as the Juniors listed at left. Unusually compact, mounts in space $3\frac{1}{2} \times 2$ ", depth behind panel 3". Tunes with a 50 mmf variable capacitor. For interstage coupling between 2 beam-power tubes or between beam-power tubes and triodes. Type 2A.
C10523—Your Cost \$4.81

75 Watt Turrets

(E) For link coupling single-ended or push-pull low power stages, with tubes operating at voltages up to 850. 4" deep behind panel, 6 5/8" dia. Type JTCL, center linked, center tapped.
C10524—Your Cost \$9.38
Type JTCL, end linked, untapped.
C10525—Your Cost \$9.38

150 Watt Turrets

(E) For single and double ended circuits, with tube voltages up to 1000. 4 1/2" deep behind panel, 8 1/2" dia. Type BCL, center linked, center tapped.
C10526—Your Cost \$11.69
Type BCL, end linked, untapped.
C10527—Your Cost \$11.69

R-175 Choke

(F) Suitable for series or parallel feed circuits in rigs up to 3000 volts modulated plate supply. DC resistance 6 ohms; DC current rating 800 ma.; inductance 225 microhenries; distrib. cap. 0.6 mmfd.; 12,500 volts insul.
C14398—Your Cost \$2.09

R154U Choke

(G) For the 20, 40, and 80 meter bands. Inductance, 1 mh., D.C. Resistance 6 ohms, D.C. current, 600 ma. Wound on isolantite core.
C14397—Your Cost \$1.40

MILLEN Hash Filters

(H) To eliminate interference from mercury vapor rectifiers. Type "1" is for 82 or 83 tubes. Type "2" is for 866's. Connect in plate leads, close to tube.
C8060—Type "1" \$1.00
C8061—Type "2", per Pair . . . \$1.25

NATIONAL R100, 100U, 300 Chokes

(J) R100. (1) For receivers and low-power transmitters. Four sections on Isolantite. Wire leads. Induct., 2 1/2 mh., DC resist., 50 ohms, rating, 125 ma., dist. cap., 1 mmfd.
C14429—Each \$35.00
R100U—Same as above, for chassis mounting. (2).
C14421—Your Cost \$42.00
R300—Like R100, but 1 mh. induct.; 10 ohms DC; 300 ma. 1 mmfd. dist. cap. (1).
C14422—Your Cost \$35.00
C14423—R300U, same as R300 but type (2) mounting. \$42.00

Reliance R. F. Chokes

(K) Four pie-wound sections on Isolantite form. 2.5 mh. 150 ma., 50 ohms dc. res. Distributed cap. 1 mmfd.
C10106—Each 22¢
C10109 2.1 mh., 250 ma., heavy duty choke. Each 25¢

MILLEN RF Choke

(L) Brass tap insert molded in die-cast end, with Steatite stand-off at other end. 2.5 mh., 125 ma., 50 ohms DC resistance.
C8058—Your Cost 36¢

BUD H.F. R.F. Choke

(M) 0.5 mh. at 250 ma. DC. resistance 16 ohms. 1/4" Isolantite core.
C10124—Each 65¢

BUD UHF R.F. Choke

(N) 5.7 microhenries at 750 ma. DC resistance 1.4 ohms.
C10108—Each 21¢

HAMMARLUND Bakelite-Cased Chokes

(P) Very effective for broadcast and SW receivers. Large inductance, low distributed capacity. Bakelite case 1 1/4" diam., 1 1/2" high. Type RFC85—Passes 60 ma. 85 millih., 215 ohms.
C8525—Your Cost \$2.25
Type RFC250—250 millih. at 60 ma., 420 ohms.
C8526—Your Cost \$2.64

Reliance Transmitting Chokes

(R) Tapered 6-section winding on a ceramic dowel. Distributed capacity 1 mmf.
Stock No. Milli-henries. Cap. DC Ohms. DC Current
C10234 2.8 1000 5 \$1.62
C10235 5.5 500 12.5 1.44
C10229 5.9 200 34.9 1.44

Parasitic Suppressor

(S) Non-inductive, 50 ohm resistor with choke of 0.3 micro-H. and .003 ohms DC res. Prevents UHF parasitic oscillations.
C10021—Each \$1.15

Power Line Chokes

(T) For suppressing interference, as a filter, or to keep high RF currents from power lines. With mtg. brackets.
Stock No. Tot. Amps. Ohms D.C. Dim. Your Cost
C10017 14 5 .15 4x3/4" \$1.28
C10018 15 10 .15 6x3/4" 2.11
C10019 18 20 .045 8 1/2x1 1/2" 3.06
C10020 48 20 .085 8 1/2x1 1/2" 4.59

OHMITE R.F. Chokes

(V) Solenoid chokes designed to avoid fundamental or harmonic resonations. All 1000 ma. No brackets on 2 or 6 meter chokes.
Stock No. Band Meters. Dimen. Your Cost
C10083 2 2.3 1 1/2x1 1/2" \$0.20
C10079 6 6.2 1 1/2x1 1/2" .20
C10080 10,11, 15, 20 27.5 3 1/2x3 1/2" .81
C10081 20 & 40 85 6 1/2x3 1/2" .92
C10082 20 to 160 193 6 1/2x3 1/2" 1.26

Transmitting DIALS AND KNOBS

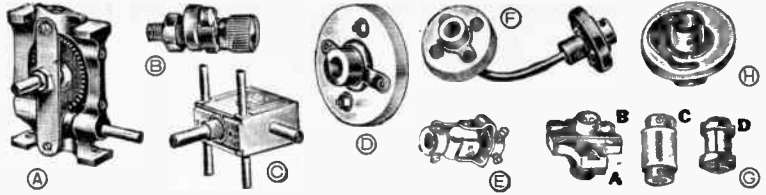

MILLEN Worm Drive

(A) Right-angle worm drive assembly for variable condensers, etc. May be panel or base mounted. Ratio 16 to 1. Frame of cast aluminum. Employs spring-loaded split gears which eliminate backlash. Drive shaft 1/4" diam.; geared shaft 1/4" dia., couples to condenser by means of flexible coupling (not supplied). Excellent for transmitters and receivers. Shpg. wt. 2 lbs.

C8000—Type 10,000\$ 4.50
Your Cost Each...

MILLEN Right Angle Drive

(C) Extremely compact right angle drive unit, ideal for operating switches and potentiometers that must be located for short leads in remote parts of chassis. Uses bevel gears. Mounts on adjustable "standoff rods," single hole panel bushing or tapped holes in frame. Case size only 1 1/2" x 1 1/2" x 3/4".

C8001—Millen No. 10012. Your Cost \$3.75

NATIONAL Shaft Couplings

(D) All take 1/4" shafts. TX-8; Isolantite ins. **51¢**
TX-9; Stantite insulation **75¢**
TX-10; Phenolic insulation. **36¢**
TX-11; Without Isolantite insulation, 4 3/8". **42¢**
Your Cost Each

MILLEN Flexible Coupling

(E) For angle drive up to 45°. Seateite insulated, for 1/4" shafts. **C8039—Your Cost 36¢**

Flexible Shaft Couplings

(F) Isolantite insulation with short length of flexible shafting. Will drive shaft at any angle up to 90°. Takes 1/4" shafts. Shpg. wt. each, 8 oz.

C14330—TX-12, 1 1/2"	84¢
C14529—TX-13, 7/8"	99¢
C14531—TX-11, Without Isolantite insulation, 4 3/8"	42¢
Solid 1/4" Shaft Couplings: Solid Isolantite.	
C14501—TX-1, 1 1/4"	66¢
C14502—TX-2, 3/4"	75¢

JOHNSON Shaft Couplings

(G) Ultrastrateite insulated units (A) and (B). Flexibility is obtained by cadmium plated phosphor bronze spring. (C) A solid insulated Ultrastrateite unit. Long leakage path and accurate alignment. (D) Cadmium plated brass compression unit.

Stk. No.	Shaft	Dia.	Ea.
C14313*	1/4"	1 1/2"	59c
C14314*	1/4"	2 1/2"	82c
C14315*	1/4"	2 1/2"	82c
C14316*	1/4" & 3/8"	2 1/2"	82c
C14317†	1/4"	1 1/2"	53c
C14318†	1/4"	1 1/2"	15c

*A & B type. †C type. ‡D type.

Flexible 1/4" Shaft Coupler

(H) For use in coupling two 1/4" shafts or for extending a shaft at an offset angle. Insulated. **C9751—Bakelite. Your Cost Each 30¢**
C9750—Ceramic. Your Cost Each 38¢

MILLEN Dial Lock

(B) Rotation of knob depresses finger which firmly clamps dial without imparting any rotary motion. Nickel plated brass. **C8079—Your Cost 45¢**



X'MITTER Knobs

For 1/4" shafts. Black bakelite (except* which are black lacquered wood).

No.	Type	Size	Ea. 10 For
C13022	A	1 1/2" d.	30c \$2.70
C13018	A*	1 1/2" d.	12c 1.08
C13004	A	1 1/2" d.	31c 2.79
C13011	A	2 1/2" d.	32c 2.88
C13010	A	3" d.	41c 3.69
C9896	B	1 1/2" d.	21c 1.89
C13014	C	1 1/2" d.	17c 1.53
C13005	C	1 1/2" d.	20c 1.80
C13013	C	1 1/2" d.	21c 1.89
C13012	C	2 1/2" d.	26c 2.34
C9885	D	1 1/2" d.	11c .99
C9886	D	1 1/2" d.	12c 1.08
C13007	E	1 1/2" d.	26c 2.34
C13008	E	1 1/2" d.	35c 3.15
C13009	E	2 1/2" d.	41c 3.69

ICA Chrome Silver Dial Plates

(F) Attractive grain satin finish. Have black Etcho-Engraving on Chrome Silver Background Plates. Finished in 3 different sizes. With various markings. Calibrations: 0-100.

Stock No.	De-grees	Dia. of Dial	Your Cost
C14184	180	2"	43c
C14191	325	2"	43c
C14192	180	3 1/2"	67c
C14193	325	3 1/2"	67c
C14194	180	4"	76c
C14195	325	4"	76c



Dial Plates

(G) Fine etched metal black dial plates, calibrated 0-10 in 300°. 2 1/4" x 1 1/2", with four mounting holes.

Plain	Tone Record	Gain Microphone
C14501—TX-1, 1 1/4"		
C14502—TX-2, 3/4"		

Specify marking desired. **For \$1.08. Ea. 24¢**

MILLEN Panel Transfers

(H) Block letters 1/4" high. Ample supply of all markings for Ham and Commercial rigs. **C8012—Black on White. Your Cost \$1.25**
C8013—White on Black. Your Cost \$1.25

SPEAKER Etched Metal Plates

(J) 1 1/2" x 3/4". With following markings:

A.C. Input	Modulator Grid
Amp. Grid Curr.	Modulator Plate
Amp. Screen Curr.	Monitor
Antenna	Oscillator
Buffer Plate Curr.	Osc. Plate Curr.
1st Buffer Grid	Output
1st Buffer Plate	50 Ohm Output
Filament Voltage	125 Ohm Output
Fil. 1st ON; 2d OFF	200 Ohm Output
Gain Control	500 Ohm Output
Input Plate	Plate Voltage
50 Ohm Input	Power Amp. Grid
125 Ohm Input	Power Amp. Plate
500 Ohm Input	Receiver
500 Ohm Input	Rectifier
Key	Send
Microphone	Speaker
Modulation Ind.	

Specify marking desired. **C9898—Any Type, Each. 9¢**



MILLEN Model 10035 Panel and Dial

(A) Four scales for hand calibration, 0-100 linear scale as guide. Escutcheon removes without disturbing dial mechanism, for easy calibration. Drive ratio 8/1. Escutcheon size 8 1/4" x 6 1/2". **C8077—Your Cost \$6.00**

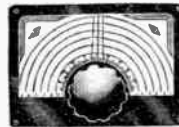

NATIONAL Type "ACN" Dial

(B) For E.C. oscillator or U.H.F. receiver, 5-Range scale for hand calibration, 0-100 linear scale as guide. 2 extra scales, Lucite dial and pointer. 5:1 Vernier. Frame 5x7 1/4". 1/4" shafts. **C14474—Each \$3.00**



Precision Vernier Dials

(C) Have etched calibrations graduated from zero to 100. Large flanged knob has bushing for 1/4" knob-shafts. Shpg. wt. 1 lb.

No.	Dia.	Rot.	Each	No.	Dia.	Rot.	Each
C14236	4"	325°	\$1.62	C14238	4"	180°	\$1.62
C14237	2 1/2"	325°	1.23	C14239	2 1/2"	180°	1.23



NATIONAL R & O Dials

(E) Type R—1 1/2" Dial. Etched nickel silver. 180 degrees. Marked 0-10. 1/4" shaft. **C14566—Your Cost 51¢**
(D) Type O—3 1/2" Dial. Nickel silver. Marked 0-100. 180° counter-clockwise. Large easy-to-grip knob. For 1/4" shaft. **C14567—Your Cost 99¢**



"B" Type Vernier Dial

(F) Ratio variable from 6:1 to 20:1. Black Bakelite shell. 4" diam.

C14367—Clock 200-0 in 360°.	} Either \$1.80
C14368—0-100-0; 180°.	
Type "BM"—Without variable ratio. 3" dia.	} Either \$1.65
C14371—0-100-0; 180°.	
C14372—Clockwise, 200-0; 360°.	



Type "N" Precision Dial

(G) Engine divided scale and vernier. Reads to 1/10 of a division. Planetary drive ratio 5:1. Diam. 4". Bakelite knob.

C14363—Counter-clock. 0-100, 180°.
C14364—Clockwise 100-0, 180°.
C14365—Clockwise 150-0, 270°.
C14366—Clockwise 200-0, 360°.

Your Cost, Each. \$4.50



GORDON Hand Wheels

(H) Bakelite Wheel with pointer. Fits all 1/4" shafts. Tuning controls that will add to the appearance of X-mitting and electronic equipment. Wt. 8 oz.

C14641—3 1/2" with 180° scale.	Each \$1.23
C14642—3 1/2" with 180° scale.	Each 1.09
C14643—1 1/2" with 180° scale.	Each 1.06
C14644—1 1/2" with 180° scale.	Each .76
C14645—1 1/2" with 270° scale.	Each .82

HAND WHEELS with pointer only, less scale.

C14646—3 1/2" Your Cost	94c
C14647—2 1/2" Your Cost	82c
C14648—1 1/2" Your Cost	65c
C14649—1 1/2" Your Cost	53c



MILLEN Dial

(I) 0 to 100 Counter-clockwise, heavy gauge nickel silver dial. Metal scale is insulated from the shaft by a large black bakelite hub. Easy-to-grip type knob. Overall diameter 3 1/2". Wt. 1 lb. **C8078—Your Cost \$1.00**



ICA Miniature Dials

(K) Chrome Silver dials with black etched numerals. Equipped with finger grip black knob. Only 1 1/2" diameter. Fit 1/4" shafts. Ranges from 1-10 over 180 and also 270 degrees. Ideal for matching dials on instruments, amplifiers, receivers, etc.

C14234—0-10, 180°	Your Cost 50c
C14235—0-10, 270°	Your Cost 50c

HAMMARLUND and NATIONAL CONDENSERS

NATIONAL Variable Condensers

"TMA" Heavy Duty Units

Plates of heavy aluminum with buffed rounded edges. Isolantite insulation; 4-hole bolt-spacer panel mtg.; 1/4" shafts 1 1/2" long; 4 3/4" wide, 3 3/4" high; type A (last letter) have .171" gap; type B, .265"; type C, .359".

No.	Type & Mmfd.	Plates	Volts	Each
C14369	TMA-100B	23	9000	\$8.31
C14328	TMA-50A	7	6000	4.15
C14329	TMA-100A	15	6000	6.39
C14330	TMA-150A	21	6000	7.67
C14332	TMA-50DA*	8-8	6000	7.03
C14333	TMA-100DA*	14-14	6000	11.18
C14544	TMA-150B	35	9000	10.87
C14545	TMA-60DB*	15-15	9000	11.82
C14546	TMA-50C	13	12000	5.11
C14548	TMA-40DC*	11-11	12000	8.63

*Split stator units.

Midget Receiving Condensers

"ST" types 180° straight-line wavelength plates.

No.	Type	Mmfd.	Plates	Each
C14300	STHS15	15	3	\$0.96
C14299	ST35	35	9	1.06
C14291	ST50	50	11	1.28
C14293	ST100	100	20	1.60
C14295	ST110	110	27	1.76
C14296	ST150	150	29	1.76
C14296	STH250	250	32	2.11
C14303	STD-50	50-50	11-11	2.56
C14280	SE-50	50	11	1.60
C14282	SE-100	100	20	1.92
C14287	SEH335	335	43	2.46
C14476	STN*	18	7	1.28

*For neutralizing 10, 45, 47, etc.; 3000 V.P.

"NC-600" Neutralizing Condenser

Neutralizing condenser for use with 6L6's and similar output tubes. Thumb screw adjustment from .5 to .4 mmfd. Isolantite insulation.

C14252—Your Cost Each **32¢**

Miniature Condensers

A 1/4" shaft extension at each end makes this low-loss midget condenser especially handy where ganging is required. Steatite base. Conducting parts silver plated.

No.	Type	Mmfd.	Each
14345	PSE-25	25	\$2.15
14346	PSE-50	50	2.15
14347	PSE-75	75	2.15
14348	PSE-100	100	2.15

"TMC" Moderate Power Units

For use with RK18, RK20, 800, 830, 203A, 210, etc. Air gap is .077"; buffed plate edges; aluminum plates and heavy aluminum frame; Isolantite insulation; 3-hole panel mounting with bolts and spacers; flanged legs for base mounting; 1/4" shafts, 1 1/2" long; overall size 3 3/4" wide, 2 3/4" high (except TCN).

Letter D after type denotes split stator.

Stock No.	Natl No. & Cap.	No. Plates	Peak Volts	Your Cost
C14592	TMC-50	7	3000	\$2.81
C14593	TMC-100	13	3000	3.20
C14594	TMC-150	21	3000	3.67
C14596	TMC-300	39	3000	4.63
C14595	TMC-100D	13-13	3000	5.27
C14261	TCN*		6000	2.78

*For neutralizing 203A, 852, 204A.

"UM" Ultra Midgets

Mounted on isolantite base 1x2 1/8"; can be mounted in shield can. Shafts extend for ganging. UM1325 has two stators and a single rotor.

No.	Type	Mmfd.	Gap	Each
C14336	UM-15	15	.017	\$0.96
C14337	UM-35	35	.017	1.08
C14338	UM-50	50	.017	1.20
C14339	UM-75	75	.017	1.44
C14319	UM-100	100	.017	1.53
C14340	UMA-25	25	.042	1.62
C14341	UMB-25	25-25	.017	2.07

Low Power Units

"TMS" Aluminum plates and frames; Isolantite insulation; 1/4" shafts, 1 1/2" long; both panel mounting and 2-hole base mounting; adjustable rear bearing; TMS units have .026" air gap, TMSA units, .065"; all screws have lock-washers; overall dimensions: 1 3/4"x2 1/4". All 1000 P.V., except C14555 and C14556 are 2000 P.V.

Stock No.	Natl No. & Cap.	No. of Plates	Your Cost
C14550	TMS-100	9	\$1.76
C14551	TMS-150	14	1.92
C14552	TMS-250	22	2.11
C14553	TMS-50D*	5-5	2.72
C14554	TMS-100D*	9-9	3.20
C14549	TMS-300	27	2.56
C14555	TMSA-35	7	2.11
C14556	TMSA-50	11	2.30

*Split stator models.

"NC-800A" Neutralizing Condenser

High voltage Disc type neutralizing condenser for RCA 800, 35T, HK54 and similar tubes. Low loss steatite insulation. Has micrometer screw adjustment. Three-hole mounting.

C14259—Your Cost **\$2.70**

HAMMARLUND Variable Condensers

"HF" Micro Condensers

Cadmium plated; soldered brass plates; Isolantite insulation; single-hole mounting or base mounting.

No.	Mmfd.	Plates	Each
C8700	17.5	5	\$1.02
C8701	35	10	1.17
C8702	50	14	1.23
C8703	100	27	1.53
C8704	140	37	1.74
C8705*	30	20	1.38

Type "MC" Midget Units

Cadmium-plated soldered brass plates; Isolantite insulation; heavy aluminum ends; single-hole mount; .0245" gap; .0225" plates; 1/4" shaft, can be ganged; silver plated Beryllium wiper; 500-volt a.c. test.

No.	Plates	Cap. Mmfd	Each
C8503*	3	5.5-20	\$1.80
C8504*	5	6-35	1.86
C8505*	7	6.5-50	1.92
C8506†	11	8-80	2.04
C8507*	11	7.3-80	2.04
C8508*	14	8.3-100	2.16
C8509†	14	7.5-100	2.16
C8510†	19	9-140	2.34
C8514*	19	10-140	2.34
C8511†	27	10.3-200	2.58
C8512†	34	12-260	2.70
C8513†	43	13.5-320	2.94

†Midline. *Semi-circular plates.

NP-10 Neutralizer

New locking type. One screwdriver from one direction to adjust, lock partially, final adjust, and final lock. 2.3-10 mmfd., 3KV at minimum gap. For single-ended or push-pull tubes with grid plate cap. of 10 mmfd. or less, such as 812, 811, 8005, 740.

C8710—Each **\$3.15**

Type APC

Air-Padding Condensers

Type APC Isolantite base soldered brass plates; 0.15" air-gap; only 1 1/2"x1 1/2". Screw-driver adjustment; maintain constant capacity under all conditions.

No.	Cap. Mmfd.	Each
C8623	3 to 25	\$1.02
C8624	3.9 to 50	1.14
C8625	4.5 to 75	1.26
C8626	5.5 to 100	1.38
C8743	6.5 to 110	1.62

Dual-Spaced Midgets

.0175" air gap; Isolantite insulation; single-hole mount.

No.	Type	Mmfd.	Each
C8527	MC20MX	20	\$2.04
C8468†	MC20SX	20	2.04
C8488†	MC35MX	32	2.22
C8489†	MC50MX	50	2.52
C8502	MC100SX	100	2.94

Type "HFA" Condensers

Construction features all parts of cadmium plated brass, 1 1/8" square Isolantite end plates, 1/4" shafts, and 100% soldered construction which eliminates losses due to high resistance contacts. All plates are semi-circular, and .020" thick. Shaft extends 1/4". All rear bearings are single ball thrust. Mounting brackets as shown.

Stock No.	Hamm'l'd No.	Per Section Mmfd.	No. Plates	Air Gap	Length Ins.	Your Cost
C7233	HFA100A	100	19	.020"	1 1/2"	\$1.98
C7234	HFA140A	110	27	.020"	1 3/4"	2.31
C7235	HFA100B	10	3	.030"	2 1/2"	1.53
C7236	HFA150B	15	5	.030"	3 1/8"	1.62
C7237	HFA250B	25	7	.030"	3 1/2"	1.68
C7238	HFA500B	50	14	.030"	1 3/4"	1.86
C7239	HFA150E	15	9	.070"	1 3/4"	1.68

"HFD" Dual Units

Specs. are given per section.

No.	50	11	\$2.82
C8706	50	11	\$2.82
C8707	100	27	3.18
C8708	140	37	3.60
C8699*	16	11	2.76
C8709*	28.5	19	3.00

*Indicates double spacing.

"MCD" Split-Stator

Entire condenser built on a strong Isolantite base. Shield plate between stators. Capacities are for each section. All 3 3/8" behind panel.

No.	Type	Mmfd.	Each
C8519*	MCD110M	110	\$4.20
C8520*	MCD100M	100	3.90
C8521*	MCD50M	50	3.60

Double-Spaced Split-Stator

Have wide (.0715") spacing of plates. Other specs. as above.

No.	Type	Mmfd.	Each
C8490*	MCD35MX	31	\$4.08
C8528†	MCD35SX	31	4.08

*Midline. †Semi-Circular plates.

AMATEUR-PROFESSIONAL HEADSETS

CANNON BALL "Chief" All Bakelite Phones

(A) High grade, sensitive phones in molded bakelite housings; leather covered adjustable band; 5-ft. cord. Wt. 2 lbs. 2000 ohms imp. **\$2.50** 3000 ohms imp. **\$2.82**
C13948—Per Set. C13949—Per Set.

BRUSH Crystal Phones

(B) Range 60 to 10,000 cps. High impedance. Light and comfortable. Padded adjustable headband. With 5 ft. cord. **\$7.06**
C13924—Your Cost.

TRIMM Headsets

(C) "Dependable" Model: Well made economy model. Bakelite. Chrome-steel magnets. **\$2.44**
C13914—2000 ohms. Your Cost.

"Professional" Model: Similar to above but 4000 ohms. **\$2.94**
C13915—Your Cost.

"Featherweight" Model: Lightweight. Only 4 oz. Beautifully made. Bakelite shell and cap. Forged cobalt-steel magnets. Adjustable steel headband.

C13919—24,000 ohms impedance. \$5.88
C13918—4,000 ohms impedance. Either.

"Commercial" Model: DeLuxe super-sensitive phones. Exceptionally rugged. 3-year guarantee. A favorite of commercial operators.

C13908—17,000 ohms imp., with army-navy type plug. \$9.41
C13939—Same but 600 ohms impedance. Your Cost, Either Type.

C13912—Same as C13908 but less plug. \$8.53
C13938—Same as C13939 but less plug. 8.53

TRIMM "FEATHERWEIGHT" Lorgnette Phone



(A) With 6-ft. cord. With or without through-cord volume control housed in rounded edge plastic shell. Available in three impedances:

Low: 300 ohms; DC resistance 76 ohms; for line impedances up to 50 ohms.

Med.: 4500 ohms; DC resistance 1000 ohms; for line impedances of 200 to 500 ohms.

Hi: 9000 ohms; DC resistance 2000 ohms; for large installations using 500 ohm lines. **\$4.41**

C13882—Low; less volume control. \$7.06
C13883—Low, with volume control. 4.41
C13884—Med., less volume control. 7.06
C13885—Med., with volume control. 4.41
C13886—Hi, less volume control. 4.41
C13887—Hi, with volume control. 7.06

BRUSH "HUSHATONE"



(B) The HUSHATONE is a small streamlined, modern, thoroughly dependable extension loud speaker that will end "radio irritation" in your home. Provides individual listening choice by merely slipping it under bed or sofa pillow or under the puff of a loose pillow-back chair. The HUSHATONE is of molded plastic with attractive chrome trim. Compact—measures only 4 3/8" in diameter and 1 1/4" thick. Complete with convenient detachable extension cord. **\$9.55**
C13911—Your Cost.



Reliance DX Type Headphones

(A) For DX fans. Highly sensitive. Powerful bi-polar magnets. Featherweight shells. Adjustable headband. Weight 2 lbs. 2000-Ohm Headset **\$1.35** 3000-Ohm Headset **\$1.49**
C13892—Your Cost C13893—Your Cost
C13894—Cap 1 1/16" I.D. .12c C13895—Diaphragm 1 1/8" dia. 5c
C13898—Cap 1 1/8" I.D. .12c C13899—Diaphragm 1 1/8" dia. 5c

ACME DeLuxe Headphones

Has chrome steel magnets and weighs only 6 ounces complete with two units. 4 1/2 foot cord and metal headband.

C13904—Double Headset. 2000 ohms d.c. resistance. \$1.60 **C13905—Single Headset. 1000 ohms d.c. resistance. 95c**
Each. Each.

BRANDES "Admiral" Headphones

(A) Compact; efficient; powerful magnets; with 5 ft. cord and adjustable clips. **\$2.15**

C13928—2000 ohms. Your Cost. \$2.30
C13929—3000 ohms. Your Cost. 2.75
C13930—5000 ohms. Your Cost.

BRANDES "Superior" Headphones

2000 ohms. Similar to above but with exposed screw terminals. **\$1.99**

C13925—Your Cost, Per Set. \$1.8c
C13936—Bakelite Cap (fits all models). Each. 18c
C13935—Aluminum Cap (fits all models). Each. 18c
C13937—Diaphragm only (fits all models). Each. 5c

Reliance Single Unit Headsets

(C) Featherweight shell. Bi-polar magnet. Clock-steel band permanently attached. With 4 1/2-ft. cord. **\$90c**

C13896—1000 ohm single set. 90c
Your Cost.

C13897—1500 ohm single set. 98c

BRUSH Crystal Single Headset

(C) Metallic headband with rubber end cushion. 5-ft. cord. **\$3.79**

C13922—Your Cost.

BRUSH Crystal Lorgnette Phone

(D) Single phone with chromium and black enameled handle. Extends from 12" to 17". 5-ft. cord. Shipping weight 1 lb. **\$4.82**

C13923—Your Cost.

TELEX MONOSET

(E) Stethoscope-type. Tenite tubes. Replaceable ear pieces hang above earlobes, not inserted into ear. Light, only 1.2 oz. Comfortable. No matted hair. Ideal for amateur radio operators or typing from transcription machines. 2000 ohms. Excellent fidelity. Thru-line volume control clips to lapel.

C13890—Less volume control. \$7.35
Your Cost.

C13891—With volume control. \$9.70



Extension Cord Connector

(A) Has 2 openings, at either end, for inserting two pin tips. Molded body. **\$10c**
C13051—Your Cost.

Popular Phone Plugs

(C) For 1 or 2 phone or speaker cords. Bakelite shell. 2 1/4 x 3/4". **\$27c**
C14974—Black. 27c
C14971—Red. Each. \$2.43
10 for.

Headphone Cushions

(B) Soft rubber. Fits all headphones. **\$65c**
C13943—Pair. 65c
Your Cost. 55.85
10 Pairs for.

Metal Shell Type

Same with nickle-plated brass shell. 3 3/8 x 3/4". 10 For \$4.41 **\$49c**
C14970—Each.

Midget Bakelite Plug

Bakelite shell. 2 1/4" overall x 9/16" diameter. Solder lug connections. **\$27c**
C14960—Black. C14963—Red. Your Cost 10 For \$2.43
Each.

Flat Plug

(D) Ultra-compact type, for use where space is limited. Molded bakelite body. 1 1/8" dia. 1/4" thick. Companion to the jack box with volume control for hearing-aid pews. **\$39c**
C14964—Your Cost.

Phone and Speaker Cords

(E) Cotton Braid Insulation No. Type Feet Each **\$29c**
C13955 Double* 4 1/2 } 29c
C13956 Double† 4 1/2 } 29c
C13957 Single† 4 1/2 } 23c
 *Spade tips one end; straight tip. other. †Pin tips both ends.

TRIMM Outlet Box

(F) 1000 ohms, for lines up to 50 ohm impedance, or 10,000 ohms for lines up to 500 ohms. **\$2.35**
C13876—1000 ohms. Brown. 2.35
C13877—1000 ohms. Ivory. 2.35
C13878—10,000 ohms. Brown. 2.35
C13879—10,000 ohms. Ivory. 2.35
 Any of above. **\$2.35**
Your Cost.

Headphone Adapter

With 18' Cable On fibre panel. 2x2". For all sets **\$1.25**
C13942—Your Cost.

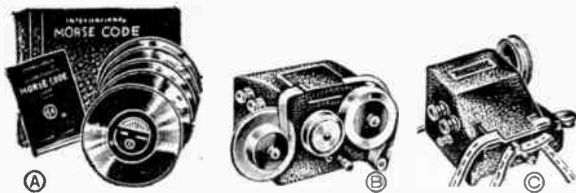

LINGUAPHONE Code Lesson Records

(A) Learn code this easy way at your own convenience. Slow down or speed up your phono as you progress. Will operate on any phonograph or record player. Includes text book and 5 double-faced 10" discs (in album). Shpg. wt. 6 lbs.

C21895—
Your Cost..... **\$8.82**

Gardiner Model 5

(B) Deluxe compact automatic tape sender. Has silent 110 volt a.c. motor. Variable code speed from 4 to 60 words per minute. Only 3 controls: motor switch, contact switch and speed control. Terminals for use with osc. or huzzer. With 10 rolls double perforated tape. Complete with case, 5" x 11" x 6". Shipped postpaid in U.S.A.

C14060—
Your Cost..... **\$20.00**

Automatic Tape Sender Model J

(C) Compact, easy to operate and highly accurate. Blank tape is spaced and punched, then run through the sender at speeds from 10 to 60 words per minute. For operation on 110-120 volts a.c. Complete with cord and plug, 5x5x3". Supplied with 5 rolls of blank tape. Shipped postpaid in U.S.A.

C14022—
Your Cost..... **\$16.50**

ICA Deluxe Signa-tone

(D) An Audio Oscillator, having 5 output frequencies and a continuously variable volume control. A number of phones and keys may be connected for class room or radio club instruction. Will follow "bug" at all speeds. Audio notes similar to those of high quality commercial CW stations. 7" x 4 1/2" x 4". Shpg. wt. 4 lbs. Complete with tube and self-contained speaker, for 110 V. A.C.-D.C.

C14086—
Your Cost, Ea. **\$11.76**

ICA Signatone

(E) For class and radio club use with earphones or speakers. Has 3 tone audio output continuously variable volume control. Extra terminals for key and phones. For 110 volt A.C. D.C.

C14076—
Your Cost..... **\$8.82**

ICA Terminal Box

(F) For quick and neat wiring of code classroom setups. Has key and phone jacks mounted in compact case.

C14077—
Your Cost..... **\$2.06**

Code Practice Set

(H) Model 450. Constant frequency adjustable buzzer and a standard hand key with 1/8" silver contacts, mounted on a brown bakelite base 6x4". Metal parts plated. Code card included. Uses 2-1 1/2 volt cells (not incl.).

C14027—SingleSet—\$2.65
C20622—1 1/2 V. cell. Ea. . . 6 1/2c

Code Keys AND ACCESSORIES

BUD

Code Practice Oscillator

(G) An audio oscillator with a built in magnetic speaker. Will also operate up to twenty headphones. Internal speaker is automatically cut out of the circuit when headphones are inserted. Provided with variable volume control and variable pitch control. Any number of keys may be connected in parallel to the oscillator for group practice. Metal case finished in grey crackle enamel. 11" x 7 1/2" x 3 1/2".

C14074—
Your Cost..... **\$12.25**

SIGNAL Model R-68 Code Practice Set

(J) Key and high frequency buzzer on a polished hardwood base. Hook battery to terminals (1 1/2 volt cell required, not supplied) and it is ready to operate. Metal code plate on base. Wt. 2 lbs.

C14001—Your Cost \$3.82

Type R-60 BUZZER ONLY:
Fully adjustable. Has standard resistance of 2 ohms. Black crystal lacquer finish.

C14006—Your Cost \$1.32

Constant Tone Buzzer

Black bakelite base and cap. Silver contacts. Adjustment on vibrator. Resist. 2 ohms. Operates on 2-1 1/2 v. cells or "C" battery.

C14021—
Your Cost..... **\$1.06**

C20622—1 1/2 V. cells. Ea. . . 6 1/2c
C19867—"C" Batt. Ea. . . 57c

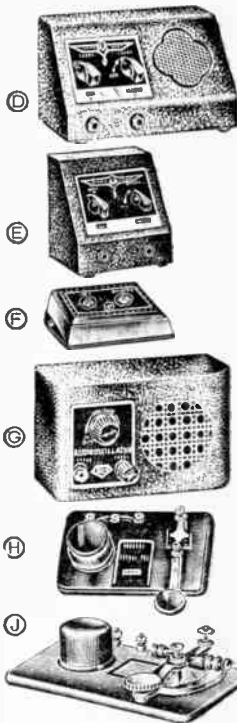

CHAMPION Code Key

(A) Heavy black wrinkle cast base, 3/8" aligned contacts, and chrome-plated key arm, with tension and side play fully adjustable.

C14068—
Your Cost..... **\$59c**

Model 300 Practice Key

(B) Has two adjustments. Bakelite base, coin silver contacts. Machined parts in bright finish. Wt. 1 lb.

C14041—
Your Cost..... **\$1.03**

Mod. 305. With metal base.
C14053—
Your Cost..... **\$1.12**

SIGNAL Practice Key Model R-50

(B) Cast base black ripple finish. Coin silver contacts. Parts are heavily plated. Easily adjustable. Shpg. wt. 1 lb.

C14009—
Your Cost..... **\$1.40**

Model 310 Manual Key

(C) Heavy die-cast metal base. Black wrinkle finish. Adjustable bearings, pure silver contacts. For light duty work. Shpg. wt. 1 lb. Without switch.

C14051—
Your Cost..... **\$1.91**

C14052—
With switch.
Your Cost..... **\$2.20**



Model 301 Key

(C) General purpose key molded black bakelite base. Well insulated. Adjustable bearings, silver contacts.

C14040—
Your Cost..... **\$1.76**

As above, with switch.
C14044—
Your Cost..... **\$2.06**

SIGNAL Key With Switch

(C) A telegraph key with switch to close contacts. Lacquered brass base. Shpg. wt. 1 lb.

C14017—
Your Cost..... **\$2.90**

C14005—
Less Switch..... **\$2.69**

Model 321 Senior Key

(D) Heavy duty key with pure silver contacts. Die cast, plated base and key arm. Adjustable steel bearings; concealed brass connector strip. Shpg. wt. 2 lbs.

C14039—
Your Cost..... **\$2.94**

Bakelite Key Knobs

Brilliant black bakelite. Navy knob with disc.

C14037—
Your Cost..... **18c**

Flat paddle as used on most speed keys.

C14038—
Your Cost..... **15c**



"Original" Vibroplex

(E) For communications work where speed and perfect Morse are essential. Single lever. Two pairs of contact points: one for dots, other for dashes. Unlimited sending possibilities. Polished parts, black base. Complete with cord and wedge. Shpg. wt., 5 lbs.

C14057—Each \$15.95

"Champion" Vibroplex

(F) Inexpensive and has exceptional sending qualities; speed and ease of operation. Single lever, two pairs of contact points (one for dots, one for dashes). Bright finish parts, black base. Shpg. wt., 4 lbs.

C14058—Each \$9.95

Model 515 Hi-Speed Key

(G) Heavy duty high speed key. Two sets of 1/4" silver contacts. Metal parts heavily plated. Black wrinkle finish, base is 3x3 1/2 x 2 1/2". High quality construction. Less switch, cord and plug. Shpg. wt., 4 lbs.

C14033—Each \$7.35

Cord and plug for above.
C14054—Your Cost..... 88c

Carrying Case for Keys

(H) Plush-lined, black morocco finish. Reinforced corners. Lock, key. Inside dimensions: 6 1/2" x 3 3/4" x 4 1/4". Shpg. wt. 3 lbs. **\$5.50**

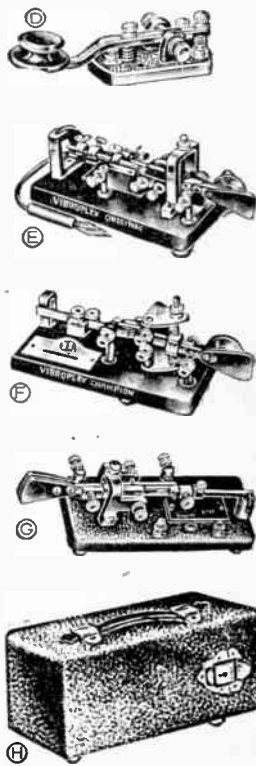

LOW LOSS INSULATORS

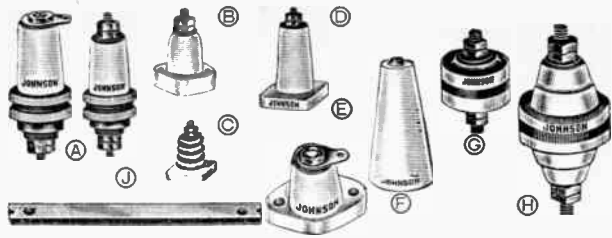

JOHNSON Thru-Panel Insulators

(A) Made of white glazed porcelain; non-hygroscopic. Feature great mechanical strength and increased breakdown voltage. Flat mounting surfaces with cushion washers eliminates breakage. All have longest possible leakage path. Jack types have terminals permitting connection above as well as below the panel. Nickel plated brass hardware furnished. Ideal for use as terminals on high frequency, high voltage and low frequency devices. Jack tops take standard banana plugs.

Stock No.	Type No.	Top Ht.	Bot. Ht.	Panel Hole	Hard-ware	Your Cost
C16736	40	1 1/4"	3/8"	3/8"	10/32	18c
C16737	40J	1 1/4"	3/8"	3/8"	Jack	24c
C16738	42	1 1/2"	3/8"	3/8"	10/32	17c
C16739	42J	1 1/2"	3/8"	3/8"	Jack	21c
C16740	44	1 3/4"	1/2"	3/8"	6/32	14c
C16741	45	1 3/4"	1/2"	3/8"	10/32	24c
C16742	45J	1 3/4"	1/2"	3/8"	Jack	29c

We can supply any Johnson products not listed here, at standard discounts from the list price.

JOHNSON Stand-Off Insulators

All-purpose stand-offs made of white glazed porcelain. All furnished with nickel-plated hardware as listed below.

Stock No.	Type No.	Fig.	Body Ht.	Hard-ware	Your Cost
C16746	22	B	1"	8/32	7c
C16748	22J	E	1"	Jack	11c
C16745	20	B	1 1/8"	10/32	10c
C16744	20J	E	1 1/8"	Jack	12c
C17024	65	C	1 1/8"	10/32	15c
C17025	66	D	2 3/8"	1/4-20	29c
C17026	67	D	4 1/2"	1/4-20	47c

JOHNSON Cones

(F) Made of ultra steatite insuring minimum of loss at high frequencies. Threads are tapped directly into the ceramic. Ideal for mounting condensers, coils, tube sockets and other high frequency apparatus. Complete with mounting hardware.

Stock No.	Ht.	B. Dia.	Thread	Each
C17005	3/8"	5/8"	6/32	12c
C17006	1"	5/8"	8/32	18c
C17007	1 1/2"	1"	8/32	32c
C17008	2"	1 1/8"	10/32	44c

JOHNSON Lead-In Bushings

For antenna lead-in bushings, panel bushings, and other applications where insulated mounting is required. Feature long leakage paths. Type A made of white glazed porcelain. Type B made of Alsimag 196; provided with all necessary hardware. Suitable for high frequency work. Cushion washers furnished.

Stock No.	Type No.	Fig.	Ht.	Di.	Lth.	Your Cost
C17020	50	H	1 1/4"	3/4"	2"	17c
C17021	51	H	1 1/2"	1 1/4"	2 1/2"	24c
C17022	52	H	1 1/2"	1 1/4"	4 1/4"	38c
C17023	55	G	1 1/2"	3/4"	1 1/4"	16c

*—Made of Alsimag 196.

JOHNSON Feeder Spreaders

(J) Silicone impregnated unglazed porcelain. Impervious to moisture. Sheds water. The ideal line spreader for receiver and transmitter lead-ins. Cross section of all sizes is 3/4"x3/8".

Stock No.	Length	Each	Your Cost
C17027	2" Long	9c
C17028	4" Long	12c
C17029	6" Long	15c

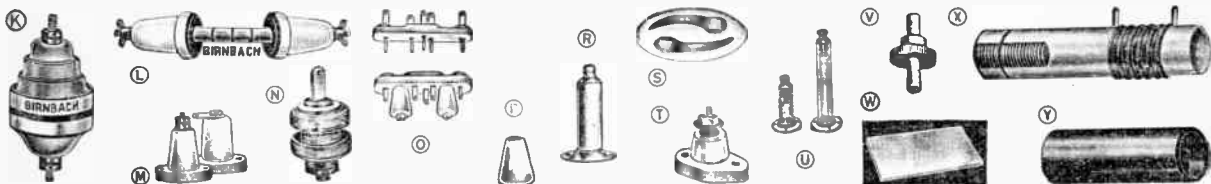

BIRNBACH Hi-Voltage Feed-Through

(K) Has high dielectric and mechanical strength. Extra long leakage path. Bottom sleeve tapped. Height 1 3/4"; base dia. 2"; mfg. hole 1 1/4". Hdwe. 1/4-20. C16712—**47c** Each.

BIRNBACH X-mitter Lead-in Insulators

(L) Each 2 3/4" high of vitrified glazed porcelain. With nickel-plated brass hardware. Also have lead and cork washers to make watertight seals.

No.	Rod	Bushing	Each
C17037	10"	Metal	51.03
C17038	15"	Metal	1.18
C17039	10"	Porcelain	1.32
C17040	15"	Porcelain	1.68

NATIONAL Steatite Stand-Offs

(M) 1 1/2" high, 1 1/8" centers. GS-8 has nut and bolt hardware; GS-9 has jack top for banana plug. C14486—GS-8. **54c** Each. C14487—GS-9. **75c** Your Cost Each.

Steatite Buttons
(N) Simplifies Wiring. Use as binding post, binding post insulator or as stand-off insulator. Special screw locks both sections. 3/8" dia. 6/32 stud. C16711—Each. **18c**

Insulantite Plug & Socket

(O) For use with XR-16 coil forms. C14614—PB-16 Plug. **27c** Your Cost Each. C14615—XB-16 Socket. **33c** Each.

Steatite Buttons
(P) Small units tapped 8/32 at each end; GS-6 and GS-7 tapped 10/32.

Stock No.	Type	Height	Each
C14493	GS-10	3/4"	7c
C14483	GS-5	1 1/4"	24c
C14484	GS-6	2"	42c
C14485	GS-7	3"	75c

NATIONAL Insulantite Stand-Offs
(R) Metal mounted top and bottom. Shaped for maximum efficiency. Ideal for r.f. choke cores.

Stock No.	Type	Di.	Ht.	Each
C14479	GS-1	1 1/2"	1 3/8"	24c
C14480	GS-2	1 1/2"	2 3/8"	30c
C14481	GS-3	3/4"	2 3/8"	60c
C14482	GS-4	3/4"	4 3/8"	75c
C14475	GS-4A	3/4"	6"	51.05

Strain Insulator

(S) A 1 1/2" glazed porcelain strain insulator for use with antenna guy wires. C17175—Your Cost Ea. **5c** 10 For. **40c**

ICA Stand-Off Insulators

(T) Made of white glazed insulox. C16730—1" high. **7c** C16731—1 1/8" high. **9c** C16732—1 1/4" high. **11c**

MILLEN Stand-Offs

(U) Quartz Q, a highly polymerized styrene. Remarkably low R.F. losses. High resistance to voltage breakdown. Fitted metal tops. Ideal for low-loss forms.

Stock No.	Type	Di.	Lth.	Each
C8008	30001	1/2"x1 3/4"		15c
C8009	30002	1/2"x2 3/4"		21c
C8010	30003	3/4"x2 3/4"		55c
C8011	30004	3/4"x4 3/8"		65c

AMPHENOL "912-A" Sheets

(W) Similar to 912-B, but polystyrene instead of acrylic. Low RF loss.

Stock No.	Overall Dimensions	Your Cost
C8025	4x8x1 1/16"	16c
C8028	4x8x3 1/2"	20c
C8026	4x8x1 1/8"	24c
C8027	4x8x1 1/4"	39c

AMPHENOL "912-A" Polystyrene Rods

(X) Molded from pure polystyrene. 6" and 12" lengths for machining special coil forms and low loss parts.

Stock No.	Di.	L.	Each
C8074	1/4"	6"	4c
C8075	3/8"	6"	9c
C8076	1/2"	6"	15c
C8067	1/2"	12"	8c
C8068	3/4"	12"	17c
C8069	1"	12"	30c
C8070	1"	12"	51.26

AMPHENOL "912-B" Sheets

(Y) Strong, clear flexible material (Acrylic) for high frequency, RF or high-voltage work. Does not deteriorate with age and will not discolor. Absorbs little moisture; water content only .8%. Can be cut, drilled, machined, etc. Can be shaped when heated.

Stock No.	Overall Dimensions	Your Cost
C8071	6x8x1 1/16"	50.59
C8072	6x8x1 1/8"	1.18
C8073	6x8x3 1/16"	1.73

MILLEN Feed-Through Bushing

(V) Small insulantite unit; lead shoulder for 1/4" hole. C7999—**25c** 5 For.

AMPHENOL "912-A" Tubing

Polystyrene tubes 12" long with 1/16" wall thickness. Ideal for coil forms. Extremely low RF loss.

Stock No.	Overall Diameter	Your Cost
C8029	5/16"	9c
C8030	3/8"	11c
C8031	1/2"	19c

AMPHENOL "912-B" Strips

A synthetic resin having transparency greater than most glass and having good electrical insulation characteristics. Can be shaped (when heated), drilled, cut, etc. Very strong. **1/8" strips, 12" long, 1/16" thick.** For coil supports, transmission line spreaders, trimmer bases, or binding post or tip jack mounting strips.

Stock No.	Width	Each
C8063	3/4"	12c
C8064	1 1/2"	18c
C8065	3/4"	24c
C8066	1"	30c

BAKELITE Tubing

(Y) In natural smooth black, 1/16" thick wall. Cut to your length, any size.

Stock No.	Out. Diam	Per Foot	Per 1/2 Ft.
C13150	1"	52c	29c
C13151	1 1/2"	67c	38c
C13152	2"	83c	46c
C13153	2 1/2"	98c	55c
C13154	3"	114c	64c

Natural Tan Color, 1/16" Wall

Stock No.	Di.	Per Foot	Per 1/2 Ft.
C13129	1/4"	31c	18c
C13130	3/8"	33c	19c
C13131	1/2"	37c	21c
C13132	3/4"	44c	25c



Industrial Tubes

Ignitrons

High-peak-current gas-filled tubes with a mercury pool cathode. Supply heavy current for use in spot or seam welding. Used in place of rotating machinery for changing AC to DC.

Stock No.	G-E Type	Max. Amps.	Your Cost
C24776	GL-415	22.4	\$ 42.00
C24777	FG-271	56.0	70.00
C24778	FG-235A	140.0	105.00
C24779	FG-258A	355.0	230.00

Phototubes

Gas-filled and high-vacuum types. No grid.

Stock No.	G-E Type	Kind	Anode Volts	Net Each
C24780	PJ-22	Vacuum	200	\$2.20
C24781	PJ-23	Gas	90	2.15
C24782	FJ-401	Gas	90	2.55
C24783	GL-441	Vacuum	200	4.50

Thyratrons

Grid-controlled gaseous discharge rectifier tubes with one or more grids to control the starting of the plate current. Will run d-c motors directly from a-c lines. Will hold desired motor speed constant.

Stock No.	G-E Type	Avg. Amps.	Peak Amps.	Net Each
C24784	FG-97	0.5	2.0	\$20.00
C24785	FG-17	0.5	2.0	6.50
C24786	FG-27A	2.5	10.0	19.00
C24787	FG-33	2.5	15.0	19.00
C24788	FG-57	2.5	15.0	17.50
C24789	FG-95	2.5	15.0	21.00
C24790	FG-105	6.4	40.0	44.00
C24791	FG-172	6.1	40.0	42.00

TAYLOR Power Tubes

As factory representatives we are in a position to quote special prices to quantity users of TAYLOR high quality tubes. Contact us, stating quantity and types desired. The well known, heavy duty 866A-866, shown at left, has ceramic insulation between plate cap and glass, assuring breakdown protection. Peak inverse voltage, 10,000 volts. Peak current 1 amp.

C24735—Type 866A, 866—Fil; 2.5V at 5A, net. . . . \$1.50

C24736 Type 866—Jr. Lighter duty version of above. 1.00



EIMAC Power Tubes

Famous for their efficiency, long life, and performance.

Stock No.	Type	Your Cost	Stock No.	Type	Your Cost
C24700	3X2500A3	\$165.00	C24708	35T	\$ 7.00
C24701	4-65A	14.50	C24709	35TG	8.00
C24702	4-125A	25.00	C24710	75TL	10.50
C24703	4X150A	31.00	C24711	75TH	10.50
C24704	4-250A	36.00	C24712	100TL	15.00
C24705	4X500A	85.00	C24713	100TH	15.00
C24706	3C21-24G	6.00	C24714	250TL	27.50
C24707	25T	6.00	C24715	250TH	27.50

HYTRON Tubes

Stock No.	Type	Your Cost	Stock No.	Type	Your Cost
C24740	OA2	\$2.30	C24749	HY615	\$2.25
C24741	OB2	2.30	C24750	801A	3.00
C24742	2E25	3.95	C24751	807	2.30
C24743	2E30	2.25	C24752	816*	1.25
C24744	HY21	1.50	C24753	866A/866	1.75
C24745	HY31Z	3.95	C24754	HY1231Z	4.50
C24746	HY69	3.95	C24755	HY1269	4.50
C24747	HY75A	3.95	C24756	551††	3.95
C24748	HY114B	2.25	C24757	5516	3.95

*Replaces type 866 Jr.

†Replaces types HY30Z, 40, 40Z, 51A, 51B, and 51Z.



HEINTZ and KAUFMAN Gammatrons

Stock No.	Type	Your Cost	Stock No.	Type	Your Cost
C24763	21	\$ 4.75	C24767	257B	\$24.50
C24764	51	8.00	C24768	354C	24.50
C24765	57*	15.00	C24769	451††	27.50
C24766	254	13.50	C24770	8541††	60.00

*New air-cooled beam pentode, 50 watt diss. VHF without neutralization. Very low driving power. Tantalum grid and plate.

†High-Mu types (Low-Mu on special order).

Taylor General Purpose Tubes

Stock No.	Type	Watts Diss.	Your Cost	Stock No.	Type	Watts Diss.	Your Cost
C24721	T-20	20	\$ 2.75	C24728	T-55	55	\$ 6.50
C24722	TUF-20	20	5.50	C24729	T-125	125	13.50
C24723	TZ-20	20	2.75	C24730	T-200	200	21.50
C24724	T-21	21	1.95	C24731	203-A	100	12.00
C24725	TB-35	35	10.00	C24732	203-Z	65	9.00
C24726	T-40	40	3.95	C24733	803	125	21.00
C24727	TZ-40	40	3.95	C24734	822	200	18.50

TRANSMITTING AND SPECIAL PURPOSE TUBES

As one of the largest distributors of RCA tubes, we carry a complete stock of transmitting, power, and special purpose types. If the particular type you want is not listed, please write for quotation. RCA tubes are widely used in and throughout the fields of Radio and Electronics.

G-E monogram tubes are manufactured with the most modern high-precision equipment, and are pretested to insure long trouble-free-service. A written warranty further assures you of full dollar-value from every G-E tube you purchase and install.

RCA			GE			RCA			GE			RCA			GE		
Stock No.	Your Cost	Type	Stock No.	Your Cost	Type	Stock No.	Your Cost	Type	Stock No.	Your Cost	Type	Stock No.	Your Cost	Type	Stock No.	Your Cost	Type
C24797	\$2.30	OA2	C24566	\$1.20	C24836	\$12.50	828	C24604	\$12.50	C24875	\$ 2.70	1851	C24643	\$ 2.70
C24798	1.20	OA3/VR75	C24837	14.75	829B	C24605	14.75	C24876	1.70	2050	C24644	1.70
C24799	1.15	OA1G	C24838	10.60	832A	C24606	10.60	C24877	1.70	2051	C24645	1.70
C24801	1.20	OB3/VR90	C24568	1.40	C24839	4.15	837	C24607	4.15	C24878	7.00	8005	C24646	7.00
C24802	1.20	OC3/VR105	C24569	1.20	C24840	3.80	811	C24609	12.00	C24879	14.00	8012A	C24647	14.00
C24803	2.20	1C21	C24570	1.20	C24841	12.00	815	C24610	1.75	C24880	9.00	8013A	C24648	9.00
C24804	13.60	2C10	C24572	13.50	C24842	1.75	806A	C24611	1.75	C24881	2.70	9001	C24649	2.70
C24805	10.30	2C43	C24573	10.30	C24843	2.15	808	C24612	7.50	C24882	2.15	9002	C24650	2.15
C24806	1.80	2D21	C24574	1.80	C24844	7.50	872A	C24883	2.70	9003	C24651	2.70
C24807	5.10	2E21	C24575	5.10	C24845	11.00	878	C24614	1.70	C24884	1.40	9006	C24652	1.40
C24808	3.50	2E26	C24576	3.50	C24846	1.70	884	C24615	1.80	
C24809	2.75	2V3G	C24847	1.80	885	C24616	3.00	
C24810	1.80	2X2/879	C24578	1.80	C24848	3.00	917	C24617	2.60	
C24811	5.80	3B25	C24849	2.60	918	C24618	3.00	
C24812	11.00	3C23	C24580	12.00	C24850	3.00	919	C24619	3.60	
C24813	12.00	3D22	C24851	3.60	920	C24620	1.75	
C24814	25.00	4-125A/1D21	C24582	25.00	C24852	1.75	921	C24621	1.80	
C24815	1.30	5R1GY	C24583	1.30	C24853	1.75	922	C24622	1.75	
C24816	1.50	6AG7Y	C24854	1.85	923	
C24817	2.15	6AK5	C24855	2.50	924	
C24818	4.90	6J1	C24856	2.50	926	C24625	2.50	
C24819	2.30	10Y	C24857	2.50	927	C24626	1.75	
C24820	12.00	203A	C24588	12.00	C24858	1.50	930	C24627	1.50	
C24821	12.00	801A	C24589	12.00	C24859	4.90	931A	C24628	9.25	
C24822	3.00	801A	C24590	3.00	C24860	3.10	934	C24629	4.90	
C24823	4.25	802	C24591	4.25	C24861	4.25	935	C24630	3.10	
C24824	10.00	805	C24592	11.75	C24862	5.45	936	C24631	5.45	
C24825	2.30	807	C24593	2.30	C24863	3.45	937	C24632	3.25	
C24826	8.50	808	C24864	5.45	958A	
C24827	3.50	809	C24595	3.50	C24865	6.15	1603	C24834	6.15	
C24828	12.50	810	C24596	12.50	C24866	2.60	1612	C24635	2.60	
C24829	3.50	811	C24597	3.50	C24867	6.00	1620	C24636	6.00	
C24830	3.50	812	C24598	3.50	C24868	2.00	1622	C24637	2.00	
C24831	14.50	813	C24599	14.50	C24869	3.50	1623	C24638	3.50	
C24832	14.00	814	C24600	12.50	C24870	3.50	1624	C24639	3.50	
C24833	6.25	815	C24601	6.25	C24871	3.50	1624	C24640	2.30	
C24834	1.25	816	C24602	1.25	C24872	2.30	1625	
C24835	9.25	826	C24603	9.25	C24873	1.60	1626	
.....	C24874	1.20	1629	C24642	1.20

LOWEST PRICES • HIGHEST QUALITY AT CONCORD RADIO

RACKS·PANELS CABINETS

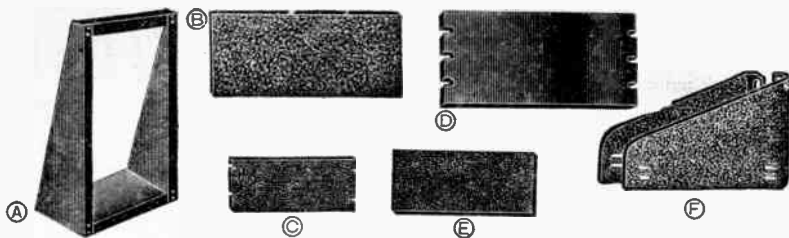

Table Racks

(A) $\frac{1}{8}$ " steel with black ripple finish. Mounting holes on $1\frac{1}{2}$ " centers, tapped for 10-32 screws. Both 20" wide and 12" deep.

C22102—25" high. Panel space 21x19". Shipping weight 33 lbs.

Your Cost **\$5.29**

C22103—32" high. Panel space 28x19". Shipping weight 36 lbs. **Your Cost** **\$6.76**

Enclosed Steel Racks

(C) Deluxe type, streamlined. Universally drilled for all standard panels. Stainless steel trimming at top and bottom. Finished in slate gray. (Black ripple available, specify on order). Panel width 19". Models are 22 $\frac{1}{2}$ " wide, 16 $\frac{1}{2}$ " deep. Hinged back. Shipped knocked down, with all hardware. With 2 locks on rear door.

Stock No.	Height In.	Panel Space	Weight Lbs.	Your Cost
C22145	42"	36 $\frac{1}{2}$ "	100	\$29.40
C22146	66 $\frac{1}{2}$ "	61 $\frac{1}{2}$ "	150	\$39.69
C22148	82 $\frac{1}{2}$ "	77"	175	47.04

Steel Channel Racks

(H) Built of $\frac{1}{8}$ " steel with spot-welded corners. Finished in ripple black. Designed for use with standard 19" long panels and are universally drilled for all standard panels. Base is 16" deep, 20" wide. Holes are tapped for 10-32 screws. Base is braced to insure freedom from wobble and to keep units in alignment. All heights shown below are overall dimensions. **C22150**—73 $\frac{1}{2}$ " high. Wt. 85 lbs. Panel space 71 $\frac{1}{4}$ ".

Your Cost **\$17.64**

C22151—38 $\frac{1}{4}$ " high. Wt. 57 lbs. Panel space 36 $\frac{3}{4}$ ". **Your Cost** **\$14.70**

MASONITE and BAKELITE Radio Panels

(B) **Masonite**: Tempered Masonite, nonmagnetic, sturdy, yet easily worked with ordinary woodworking tools. All panels $\frac{3}{8}$ " thick, finished in Black Ripple.

Bakelite: Fine grade bakelite, black finish panels, $\frac{3}{16}$ " thick. Also suitable for test instruments, meters, etc.

MASONITE PANELS

Size	Wts.	Stock No.	Each
7x10"	$\frac{3}{4}$ lb.	C22280	\$0.59
7x12"	1 lb.	C22281	.65
7x14"	1 lb.	C22282	.73
7x18"	1 lb.	C22283	.88
7x21"	1 $\frac{1}{2}$ lbs.	C22279	.97
7x24"	1 $\frac{1}{2}$ lbs.		
7x30"	2 lbs.		

BAKELITE PANELS

Stock No.	Each
C19600	\$1.32
C19601	1.62
C19602	1.91
C19603	2.41
C19604	2.73
C19605	3.23
C19608	3.97

MASONITE Relay Rack Panels

(C) Same as panels listed at left, but with amateur standard notching.

No.	Size	Each
C22267	1 $\frac{3}{4}$ x19"	\$0.50
C22268	3 $\frac{1}{2}$ x19"	.65
C22269	5 $\frac{1}{4}$ x19"	.85
C22277	7" x19"	.94
C22284	8 $\frac{3}{4}$ x19"	1.18
C22285	10 $\frac{1}{2}$ x19"	1.32
C22286	12 $\frac{1}{4}$ x19"	1.47

I.C.A. Heavy Steel Rack Panels, Black or Gray

(D) Heavy-duty $\frac{1}{8}$ " steel panels for all standard 19" racks. Available with either **black ripple** finish or with commercial **slate gray ripple**. These panels don't collect dust—and they don't show finger marks. Available in 12 standard sizes to meet any requirements.

Black No.	Gray No.	Height In.	Weight Lbs.	Your Cost
C22169	C22118	13 $\frac{1}{2}$ "	2	\$0.65
C22170	C22119	31"	5	.73
C22171	C22120	51"	7	.85
C22160	C22121	7"	8	.91
C22161	C22122	8 $\frac{3}{4}$ "	9	1.15
C22162	C22123	10 $\frac{1}{2}$ "	10	1.29
C22163	C22124	12 $\frac{1}{4}$ "	12	1.59
C22164	C22125	14"	13	1.82
C22165	C22126	15 $\frac{1}{4}$ "	14	2.12
C22166	C22127	17 $\frac{1}{2}$ "	15	2.26
C22167	C22128	19 $\frac{1}{4}$ "	16	2.45
C22168	C22129	21"	17	2.76

I.C.A. $\frac{1}{16}$ " Steel Panels

(E) **Black wrinkle finish**. For all radio applications.

No.	Size	Wt.	Each
C22218	7x10"	2 lbs.	\$0.47
C22219	7x12"	2 lbs.	.53
C22220	7x14"	3 lbs.	.71
C22221	7x18"	4 lbs.	.88

$\frac{1}{16}$ " Steel Mounting Brackets

(F) Panels must be at least 7" high. Mounting holes drilled. **★ Black Ripple Finish**

Stock No.	Size, Base	Per Pair
C15271	8"	\$0.73
C15272	11"	1.12
C15269	13"	1.29

I.C.A. Steel Cabinets for Rack Panels

- ★ Standard Rack Panel Mounting
- ★ Built-in Louvres - Latch Covers
- ★ Regular Black Ripple Finish

(A) Heavy-duty cabinets built of $\frac{1}{8}$ " steel and finished in black ripple. **Standard** and **DeLux** models. Standard models have square re-enforced corners; spot welded joints. DeLux models have neatly rounded corners. Both types are universally drilled to take all standard 19" rack panels. All have louvres and latch covers. All take chassis 13" deep.

De Lux available with slate gray finish on special order.

Standard Steel Cabinets

Stock No.	Cabinet Dimensions	Panel Space	Door Location	Shpg. Wt.	Your Cost
C22194	8 $\frac{3}{4}$ x19x13 $\frac{1}{2}$ "	8 $\frac{3}{4}$ x19"	Top Only	20 lbs.	\$ 7.35
C22070	12 $\frac{1}{2}$ x19x13 $\frac{1}{2}$ "	12 $\frac{1}{2}$ x19"	Top Only	27 lbs.	10.73
C22193	17 $\frac{1}{2}$ x19x13 $\frac{1}{2}$ "	17 $\frac{1}{2}$ x19"	Top & Rear	34 lbs.	13.82
C22192	26 $\frac{1}{2}$ x19x13 $\frac{1}{2}$ "	26 $\frac{1}{2}$ x19"	Rear Only	47 lbs.	15.14
C22190	35" x19x13 $\frac{1}{2}$ "	35" x19"	Rear Only	55 lbs.	18.43

I.C.A. De Lux Steel Cabinets

Stock No.	Dimensions	Panel Space	Door Location	Shpg. Wt.	Your Cost
C22188	10 $\frac{1}{2}$ x21x13 $\frac{1}{2}$ "	8 $\frac{3}{4}$ x19"	Top Only	22 lbs.	\$ 9.70
C22071	14" x21x13 $\frac{1}{2}$ "	12 $\frac{1}{2}$ x19"	Top Only	29 lbs.	11.76
C22191	19 $\frac{1}{2}$ x21x13 $\frac{1}{2}$ "	17 $\frac{1}{2}$ x19"	Top & Rear	34 lbs.	16.32
C22198	28" x21x13 $\frac{1}{2}$ "	26 $\frac{1}{2}$ x19"	Rear Only	69 lbs.	18.82
C22199	36 $\frac{1}{2}$ x21x13 $\frac{1}{2}$ "	35" x19"	Rear Only	73 lbs.	20.87

I.C.A. Portable Steel Cabinets

(B) For housing oscillators, transceivers, test equipment. Front and back panels are removable. Equipped with leather handle. Finished in black ripple.

No.	Size	Your Cost
C22273	12x7 $\frac{3}{4}$ x7"	\$2.50
C22274	15x7 $\frac{3}{4}$ x7"	2.91
C22275	Chassis for above (7 $\frac{1}{2}$ x6 $\frac{3}{4}$ x2 $\frac{1}{2}$ ")	.59

I.C.A. DeLux Hinged Steel Cabinets

(C) Attractive streamlined cabinets, with full length piano hinged top and removable front panel. Chrome trim moulding and ventilators on side. Finished in slate gray ripple enamel. All less chassis.

No.	H. L. D.	Panel	For Chassis	Each
C22087	8x10x 8"	8x 8"	7x 7x2"	\$4.26
C22088	8x12x 8"	8x10"	7x 9x2"	4.42
C22089	8x14x 8"	8x12"	7x13x2"	5.25
C22091	12x20x12"	12x18"	10x17x3"	8.23

I.C.A. Standard Hinged Steel Cabinets

Similar to above, less chrome trim with ventilating louvres.

Stock No.	Dimen.	Panel Size	Your Cost
C22200	8x10x 8"	8x 8"	\$2.94
C22201	8x12x 8"	8x10"	3.23
C22202	8x14x 8"	8x12"	4.12
C22203	12x20x12"	12x18"	7.64

I.C.A. General Utility Steel Cabinets

- ★ Sheet Steel
- ★ Spot Welded Corners

(D) Can be used for a multitude of radio and other purposes. All are substantially made of sheet steel, with spot welded re-inforced corners. The tops and bottoms are removable; held in place by means of self-tapping screws that are furnished. Black ripple.

No.	Size	Shpg. Wt.	Each
C22209	4x 2x 4"	2 lbs.	\$0.76
C22210	1x 3x 5"	3 lbs.	.82
C22174	6x 6x 6"	3 lbs.	.91
C22175	9x 5x 6"	5 lbs.	1.47
C22173	10x 8x 7"	6 lbs.	1.85
C22176	10x 8x10"	7 lbs.	2.26
C22177	11x12x 8"	9 lbs.	2.45
C22181	12x 7x 6"	5 lbs.	1.82
C22182	15x 9x 7"	10 lbs.	2.56

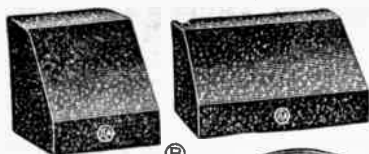

ICA Sloping Panel Steel Cabinets

Streamlined cabinets with rounded corners. Compact and rugged. For use as speaker cabinets, oscillator cases, monitors, tele-talk systems, small receivers, etc. Both have marine gray ripple finish.

		Wt.	Each
C22097	(A) 4 1/4 x 11 1/2 x 11 1/2"	2 lbs.	\$1.26
C22098	(B) 7 1/2 x 11 1/2 x 11 1/2"	5 lbs.	2.26

ICA Sloping Front Cabinets

Trimmed with red-stripped moulding, with slate gray ripple finish. Front panel removable. Rear with openings for ventilation, leads, etc. Less chassis.

Stock No.	H.W.D.	For Chassis	Shpg. Wt.	Your Cost
C22292	8x 8x 8"	7x 7x 2"	6 lbs.	\$3.88
C22093	8x10 x 8"	7x 9x 2"	7 lbs.	4.26
C22094	8x14x 8"	7x13x 2"	8 lbs.	5.59
C22096	12x18x12"	10x17x 3"	14 lbs.	7.50

Chrome Handles

A beautiful adornment for any cabinet, amplifier chassis transmitter, etc. With mtg. screws. 4" long. Mtg. centers 2 3/4".

C14563—Your Cost..... **44¢**



ICA Standard Amplifier Foundation Chassis

Streamlined amplifier chassis and covers, with new decorative grille-type ventilators. Chassis stamped from one piece cold-rolled steel, unished in black ripple. Covers are 6" deep and slate gray, presenting a contrasting two-tone effect. Chassis are drilled for bottom plates (not supplied) see listing on opposite page. Chassis height 3".

No.	Size	Wt.	Each
C22132	5 1/2 x 10 x 9"	9 lbs.	\$2.20
C22138	8 x 12 x 9"	10 lbs.	3.23
C22135	7 x 17 x 9"	11 lbs.	3.38
C22136	10 x 14 x 9"	11 lbs.	3.67
C22137	10 x 17 x 9"	13 lbs.	3.82

ICA Deluxe Amplifier Chassis. Same as above but with chromium molding and handles.

No.	Size	Wt.	Each
C22185	5 1/2 x 10 x 9"	9 lbs.	\$3.62
C22139	8 x 12 x 9"	11 lbs.	4.70
C22185	7 x 17 x 9"	11 lbs.	4.85
C22186	10 x 14 x 9"	11 lbs.	5.29
C22187	10 x 17 x 9"	13 lbs.	5.59

Super Streamlined Amplifier Chassis

New modern streamlined design. Sloping front panel and streamline top cover. Front panel is removable and extends 3" from face of screen top. Finished in marine gray ripple, chrome metal trim. Top cover 6 1/2" high. Supplied with bottom plates, but less chassis.

Stock No.	Chassis Size	Your Cost
C22195	10x12x3"	\$5.88
C22196	10x17x3"	6.76
C22197	13x17x3"	7.64

ICA Sloping Chassis Units

Deluxe steel amplifier units with sloping fronts on chassis bases. Bases equipped with chrome trimmed handles; top covers have beautiful chrome plated "air gate" ventilators with red striped chrome trim. Ventilating louvres on sides and back. Raised screen openings on top, with red striped chrome molding. Rounded corners. Marine gray ripple finish. All have 4" slope; bases 3 1/2" high.

No.	Overall	Bottom	Wt.	Each
C22131	7x17x9 1/2"	10x17"	11 lbs.	\$6.03
C22134	10x14x9 1/2"	13x14"	11 lbs.	6.47
C22147	10x17x9 1/2"	13x17"	11 lbs.	6.76

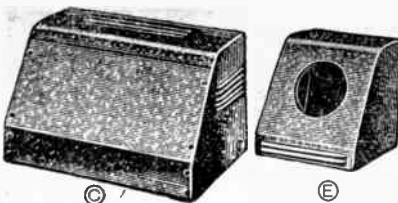

ICA DeLuxe Meter Cases

Designed to harmonize with the trend of modern streamlined equipment. Finished in Marine Gray Ripple Enamel and trimmed with red striped Chrome band. For 3" meters.

C22080	4 1/2 x 4 1/2 x 4 1/2"	Meter Hole 2 1/4"	Your Cost.....	\$1.32
C22081	Same as above with 2 3/16" meter hole.		Your Cost.....	\$1.32

MILLEN Quartz "Q" Sheet

For panels, condenser mtg., insulation, etc. Drills and cuts rapidly. Quartz "Q" is a highly polymerized styrene having remarkably low R.F. loss and high resistance to voltage breakdown. Size: 3x8 1/2"; 1/10" thick.

C8024—Millen No. 5F001. Your Cost Ea. 45¢

Shearing Punch

Cuts any size odd shape hole (square, rectangular, hexagon, etc.), on any size panel or chassis. Only hammer is necessary. Can be used in a punch press. Wt. 5 lbs.

C15067—Your Cost Each..... **\$9.70**

FOUNDATION CABINETS·CHASSIS

GREENLEE Punches



Driven by screw action, this handy tool quickly cuts clean accurate holes for sockets, plugs, etc., in radio chassis. Only necessary to drill 3/8" or 1/2" hole to fit 3/8" cap screw; 3/4" or larger hole to fit 3/4" cap screw. Each size tool consists of the punch, die for supporting the metal and cap screw. Wt. 2 lbs.

C15129	1/4" Complete.		
C15130	3/8" Complete.		
C15131	1/2" Complete.		
C15132	3/4" Complete.		
Your Cost Any of Above... \$1.94			
C15134	Screw for 3/8" and 1/2" Punches.	Your Cost.....	23¢
C15135	Screw for 3/4" and 3/8" Punches.	Each.....	23¢
C15136	1" Complete.		\$2.12
C15137	1 1/4" Cplt.		
C15138	1 1/2" Cplt.		
C15139	1 3/4" Cplt.		
C15140	1 7/8" Cplt.		
C15141	2" Cplt.		
C15142	1 1/2" Complete.		\$2.57
C15143	1 3/4" Complete.		2.88
C15118	Screw for 1" to 1 1/2" inclusive.	Each.....	23¢
C15146	2 1/4" Complete.		\$5.58
C15147	Screw for 2 1/4" Punch.		45¢

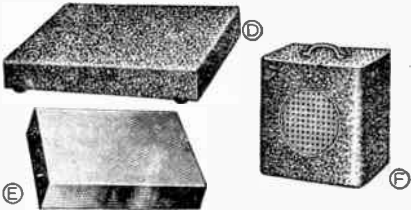

Blank Metal Chassis Bases

Here's your chance to buy all-purpose radio chassis undrilled, at unusually low prices. All have reinforced spot welded corners for extra strength.

Three types available: Electralloy is a non-magnetic zinc. Steel, plated with lead or zinc as available; also Steel with black wrinkle finish.

Electralloy		Plated Steel		Black Wrinkle	
No.	Each	No.	Each	No.	Each
C2220	\$0.69	C22299	\$0.54	C22306	\$0.56
Length: 5"	Width: 9 1/2"	Ht.: 1 1/2"	Wt. 3 lbs.		
C22321	.99	C22300	.72	C22307	.74
Length: 5 1/2"	Width: 10"	Ht.: 3"	Wt. 3 lbs.		
C22322	.82	C22301	.67	C22250	.69
Length: 7"	Width: 7 1/2"	Ht.: 2"	Wt. 3 lbs.		
C22331	.90	C22325	.72	C22251	.74
Length: 7"	Width: 9"	Ht.: 2"	Wt. 3 lbs.		
C22332	.99	C22326	.78	C22308	.80
Length: 7"	Width: 11"	Ht.: 3"	Wt. 3 lbs.		
C22323	1.26	C22302	.90	C22309	.92
Length: 7"	Width: 12"	Ht.: 3"	Wt. 4 lbs.		
C22333	1.10	C22327	.86	C22252	.88
Length: 7"	Width: 13"	Ht.: 2"	Wt. 4 lbs.		
C22324	1.65	C22303	1.06	C22313	1.09
Length: 7"	Width: 17"	Ht.: 3"	Wt. 5 lbs.		
C22334	1.59	C22328	1.15	C22253	1.17
Length: 10"	Width: 12"	Ht.: 3"	Wt. 5 lbs.		
C22337	1.69	C22304	1.20	C22318	1.22
Length: 10"	Width: 14"	Ht.: 3"	Wt. 6 lbs.		
C22335	1.85	C22329	1.07	C22254	1.09
Length: 10"	Width: 17"	Ht.: 3"	Wt. 6 lbs.		
C22336	2.19	C22330	1.60	C22255	1.64
Length: 10"	Width: 23"	Ht.: 3"	Wt. 7 lbs.		
C22338	2.25	C22305	1.98	C22319	2.02
Length: 13"	Width: 17"	Ht.: 3"	Wt. 7 lbs.		

ICA Standard Speaker Cabinets

Substantially made from sheet steel, with louvred back cover with slots for wall hanging. Finished in black ripple enamel.

Stock No.	Spkr.	Size Cabinet	Shpg. Wt.	Your Cost
C22140	6"	10x10x6"	8 lbs.	\$3.00
C22141	8"	12x12x7"	9 lbs.	3.59
C22142	10"	14x14x8"	15 lbs.	4.70
C22143	12"	16x16x8"	20 lbs.	6.31

FLUORESCENT LIGHTING

Fluorescent Kitchen Unit

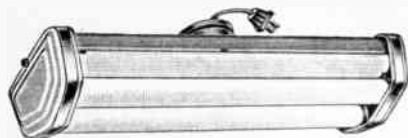

With this unit fluorescent lighting can be installed instantly in any incandescent type of fixture employing a globe with a 4" diameter holder. This particular Kitchen unit is complete with

4" Fitter. No electrical knowledge is necessary—just insert the plug of the adaptor in the shade holder and enjoy modern better lighting instantly.

Although listed as a Kitchen unit, this is a superbly designed fixture whereby the average householder can install fluorescent lighting in not only the kitchen, but in the bathroom, hallway and many other places where a soft light is desired. Underwriters' approved materials have been used throughout. Finished in baked-on white plastic "glaz-enamel." Wired for 110-125 volts, 60 cycles alternating current only. For use with two 20-watt, 24" fluorescent lamps. Shpg. Wt. 7 lbs. **\$5.70**

C25551—Your Cost (Less Lamps) 56c
C25535—White Lamp, Each 68c C25536—Daylight Lamp, Each 68c

WARD Fluorescent Kitchen Unit

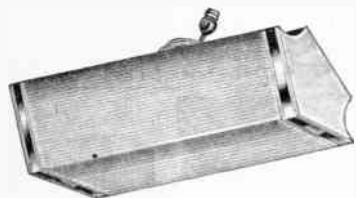

Beautifully designed fluorescent unit for kitchen use. Special interior finish distributes light scientifically through glass shields for maximum illumination. Can be installed instantly in any incandescent type fixture employing 4" diameter holder. Unit complete with ring plug on short cord and 4" diameter

ring. Fixture is 25" long. Shipping weight 12 lbs. **\$7.35**

C25555—Your Cost

Bed and Utility Lamp

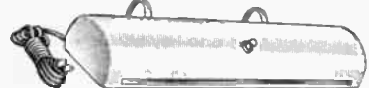

with stainless steel. The universal type of mounting brackets at the rear of this lamp enables this unit to be fastened wherever desirable. May be easily hooked into the headrest of your bed. Its attractive lines make it suitable for many other applications too, such as: over pictures, bulletin boards, music stands, cashier cages, etc.

Has a high efficiency white enameled reflector that gets every bit of light out of the fifteen watt 18" fluorescent lamp. This fixture is ready for use on 110-125 volts, 60 cycle alternating current only. Shpg. wt., 4 lbs.

C25552—Your Cost (Less Lamp) \$5.07
C25496—White Fluorescent Lamp, Each 56c
C25497—Daylight Fluorescent Lamp, Each 56c

All-Steel Industrialite



For high intensity, localized lighting of production, assembly, and inspection lines, over benches, machines,

tables. Underwriters approved. Has been engineered for flush, chain or stem mounting and has double knockouts at each end for switches or for end to end continuous row mounting. Knockouts along top for stem mounting.

Maximum lighting efficiency assured by the use of a pressed steel reflector of "glaz-enamel." Ballast fully enclosed, and starters easily accessible on side of pressed steel housing. For use on 110 volt, 60 cycle AC only. Uses two 40 watt, 48" lamps. High power factor corrected. Reflector can be easily removed for cleaning without disturbing the wiring.

C25565—Your Cost (Less Lamps) \$13.99
C25539—White Fluorescent Lamp, Each 90c
C25540—Daylight Fluorescent Lamp, Each 90c

Industrialite Accessories

C25690—U/L Approved Cord and Plug Set, 6½' L. \$1.02
C25691—Levolier Switch with pull chain \$1.02
C25692—6 ft. Electro Galvanized Tenso Chains with S Hooks, Your Cost per Pair 64c



Tubular Executive Desk Lamp

- ★ Morocco Brown Finish
- ★ U.L. Approved Materials
- ★ Convenient Pen Trough

Scientifically engineered, this fine unit is built to give maximum light distribution. Combined with the latest in smart, attractive design of sturdy and substantial materials this fluorescent desk lamp has a shade and base of one piece pressed

steel construction. Gives a miraculously high lighting performance. Curved reflecting surface in baked-on white plastic "glaz-enamel" concentrates light forward to provide an even and useful light over an entire desk area. Wired exclusively with Underwriters' approved materials. For 110-125 volts, 60 cycle, alternating current only. Uses 1—15 watt, 18" type lamp. Shpg. wt. 8 lbs.

C25550—Your Cost (Less Lamp) \$5.73
C25496—White Fluorescent Lamp, Each 56c
C25497—Daylight Fluorescent Lamp, Each 56c

Circular Executive Desk Lamp

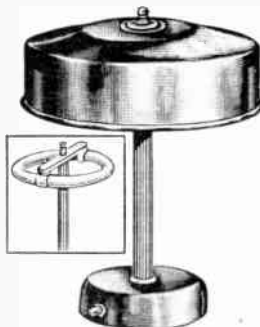

- ★ 32-Watt Circular Lamp
- ★ More Uniform Light
- ★ Instant Starting

Attractively designed, beautiful bronze finished executive desk lamp. Employs new type 32-watt circular fluorescent lamp that starts instantly without flicker. The circular construction of the lamp gives greater light intensity and more uniform distribution of light over a larger area. This type lamp permits the use of a circular shade which enhances the appearance of the lamp. The heavy base makes the lamp perfectly balanced and prevents topheaviness. An attractive lamp for offices, homes, lounges, stores, and wherever good light

and appearance are desired. For operation on 117 volts 60 cycle alternating current only. Overall size: 14¼" diameter by 18" high. Shpg. wt. 13 lbs.

C25554—With Circular Lamp \$22.00
Your Cost

COMPCO "Circline Series" Lamps

Desk and Table Lamp



Beautifully designed executive lamp for soft, glareless illumination over the entire desk or table top. Sturdily constructed of heavy gauge steel, perfectly balanced by gracefully curved base enclosing the ballast. Complete with 32-watt Circline fluorescent tube. Baked on enamel finish in metallic "statuary bronze." 15" high. Shipping weight 10 lbs.

C25557—Your Cost, With Lamp \$14.11

Pin-up Mirror Light

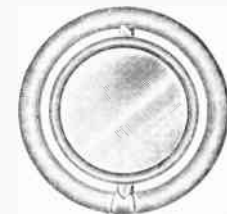

Novel decorative effect as well as fine illumination in homes, hotels and public buildings. Finest quality 8-inch plate glass mirror encircled with soft flattering fluorescent light. Uses 12-inch diameter 32-watt glareless circline. Back of fixture provided with buffers to keep fixture from laying flat on wall, allowing air circulation between wall and fixture. For 110 volt 60 cycle AC only. Complete with lamp. Shipping weight 9 lbs.

C25558—Your Cost \$12.20

Ceiling and Wall Fixture



For the kitchen, bathroom, entrance halls and playroom. Sturdily built, artistically designed fluorescent unit of heavy gauge steel. Gleaming White baked-on enamel washable finish — with polished aluminum trim. Uses the new 32 watt glareless circline tube, which gives more illumination than 100 watt incandescent. Diameter 13½ inches, fits

flush on ceiling or wall. For 110 volt 60 cycle AC only. Shpg. wt. 9 lbs. **\$10.29**
C25556—Your Cost, With Lamp

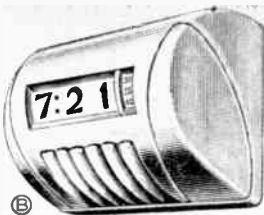
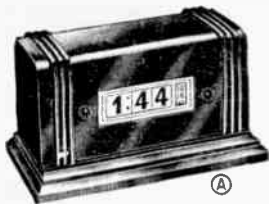

PENWOOD CLOCKS

Newly designed and styled Numechron electric clocks provide quiet, trouble-free time keeping without winding, oiling or regulating. A style and color for every need, in the home, office or elsewhere. Large 3/4-inch block numerals. Direct reading dials for the hours, minutes and seconds. Ruggedly constructed self-starting synchronous motors, precision made mechanisms and gear assemblies for accurate dependable time. Operates on 110 volts, 60 cycle AC.

(A) Commander. Desk model, beautifully styled modern plastic case. Available in Walnut or Ivory finish. Length 7 3/4", height 4", depth 4". Shpg. wt. 3 lbs.
C25450—Walnut.
C25451—Ivory.
Your Cost Each.....

\$7.11

(B) Vogue. Attractively styled Kitchen or Wall Clock. Available in Ivory finish plastic case. Length 5 3/8", height 5 3/4", depth 3 1/4".
C25452—Ivory.
Your Cost.....

\$5.81



(C) Topper. Desk or table model in non-breakable Cellulose Acetate plastic case. Recessed clock face can be easily read. Available in Walnut or Ivory finish. Length 5 3/4", height 3 3/4", depth 3 3/8". Shpg. wt. 4 lbs.
C25455—Walnut.
C25456—Ivory.
Your Cost Each.....

\$6.46

(D) Starlet. High quality streamlined plastic case. For desk, table or mantel, at home or at the office. Available in Walnut or Ivory finish. Length 5 1/2", height 3 3/8", depth 3 3/8". Shpg. wt. 3 lbs.
C25453—Walnut.
C25454—Ivory.
Your Cost Each.....

\$5.81

CLOCKS Fluorescent ACCESSORIES



TORK Commercial Electric Wall Clock Automatic Setting Feature

(E) Something new in a wall clock for stores, banks, schools, factories and warehouses. Large 16" clock face easily visible from distances of 125 ft. or more. Movement is a rugged self-starting synchronous motor with high precision gear train which includes an entirely new setting feature. Length of cord attached to small ring at bottom of clock eliminates necessity of climbing chairs or desks to reset an out-of-reach clock. Slight pull on ring speeds clock hands to 300 times normal speed for resetting. Large black numerals on white face. Hour and minute hands are black, second hand is red. Heavy spun aluminum case finished in washable baked-on maroon enamel. Dia. 16" with strong 3/4" bead, depth 2 3/4". Equipped with 6 ft. cord and plug.
C25465—Your Cost.....

\$12.37

SELECTION Clock

(F) Wake up and go to sleep tunelessly with Selection, the clock that automatically turns your radio on or off at any 15-minute point. Just plug your radio into the back of the clock and set the "Selection" switch. The "Selection" will automatically turn on your favorite radio program at the exact time you desire. Selection can also be used to turn on or off household appliances, such as a Percolator, Heating Pad and night light. Self-starting motor, precision engineered mechanism for accurate dependable time keeping. Housed in beautiful non-shatterable Celanese plastic case. With 6-ft. cord and plug. For 110 volt. AC only.
C25470—Rich Maroon Finish.
C25471—Ivory Finish.
Your Cost Each.....

\$5.25



AC to DC Conversion Ballasts

(E) 115 V AC 1-lamp fluorescent fixtures may be used on 115 V DC by plugging one of these Closestat ballasts into the DC power outlet and plugging the fixture power cord into the receptacle in the ballast. Uses a glass-insulated resistor. 3/4"x1 1/2". Wt. 2 lbs.

C13818—195 ohm, for 15W lamp.
C13819—144 ohm, for 20W lamp.
Either Type, Your Cost.....

\$1.10

Portable Fluorescent TOTELITE

New Development in Portable Lighting!

(A) TOTELITE changes the entire concept of portable, self-powered lighting. No longer a long, skinny beam, but a full flooding light. This versatile light has many applications in the home, garage, office, factory, laboratory, farm, maintenance, installation, sports, watchman, and many other uses. Just the light to meet any emergency need. Especially suitable as a trouble light for motorists and truck operators. Economical to use, for the batteries last approximately 30 hours and the 6 watt fluorescent tube lasts approximately 1000 hours. Attractive black crackle finished steel case with plastic shield-lens that is non-breakable and non-shatterable. Finger-tip control switches under handle. Size: 11"x8 1/4"x4 1/2".

List Price (with batteries).....\$15.95
C25553—Complete with batteries.
Your Cost.....

\$10.63

CORNELL-DUBILIER Noise Filter

(C) C-D Fluorescent Filter 11/24, 110 volts AC or DC. Mounts inside the fixture by slotted strap which slips under any assembly bolt. Case is grounded and leads are shunted across power line. Cylindrical, 2 1/2"x1 1/2". Shpg. wt. 1/2 lb.
C12561—Your Cost.....

65¢



Mazda Fluorescent Lamps

(D) "White" lamps provide a quality of light approximating that of the incandescent lamp. "Daylight" lamps approximate that of daylight. All supply several times the usable light output of regular incandescent lamps. Rated life better than 2500 hours.

Prices Below Include Federal Excise Tax.

White	Daylight	GE	Dimen.			Lots	Lots		
Stk.No.	Stk.No.	No.	L x D	Watts	Ea.	7	24	Ea.	24
C25533	C25534	T5	9x8 1/2	6	\$0.83	7	24	\$0.68	24
C25527	C25528	T5	12x8 1/2	8	.94	7	24	.77	24
C25496	C25497	T8	18x1 1/2	15	.68	8	24	.56	24
C25525	C25526	T12	18x1 1/2	15	.83	7	24	.68	24
C25529	C25530	T12	15x1 1/2	14	.83	7	24	.68	24
C25535	C25536	T12	21x1 1/2	20	.83	7	24	.68	24
C25537	C25538	T8	36x1 1/2	30	.83	7	24	.68	24
C25539	C25540	T12	48x1 1/2	40	1.10	5	24	.90	24
C25531	C25532	T17*	60x2 1/2	100	2.54	3	12	2.08	12
C25541	C25542	T10†	12 3/4" Od.	32	1.93	3	12	1.58	12

*100-watt lamps have mogul 2-pin base; all others have standard 2-pin base. Approx. shipping weights: 6 and 8-watt—1 1/2 lbs.; 14, 15, 20-watts—2 lbs.; 30 and 40-watt—3 1/2 lbs.; 100-watt—8 lbs. †"Circline" circular lamp. Requires special socket. I.D. is 9 1/2"x 1/8".

Note: When purchasing lamps with any fluorescent fixture listed use 1st "Lots of" price instead of single price.

Electrical Noise Suppressor

(E) Eliminates electrical noise from 115 volt 50/60 cycle AC fluorescent fixtures. Leads from filter are shunted across the power line, case is grounded to the fixture by mounting. When fixture is grounded electrical noise is shunted to ground. Cures the most obstinate cases. 4 1/4"x 1 3/4"x1 1/2". Shpg. wt. 1 lb.

C12520—Your Cost.....

75¢

IMMEDIATE SHIPMENT FROM CHICAGO OR ATLANTA

ELECTRICAL APPLIANCES and ACCESSORIES

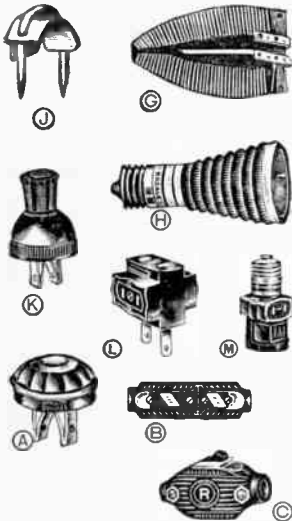

Bakelite Plug
 (A) Standard plug. Well made with sturdy prongs. **6¢**
C13306—Your Cost 54¢
 10 for \$2.25

Midget Cord Connector
 (B) Flat two-piece type. Underwriters Listed. **25¢**
C13276—Your Cost \$2.25
 10 for

Cord Switch
 (C) Line cord switches for home ceiling fixtures and appliances. **23¢**
C13275—Your Cost

Outlet Box Receptacles
 (D) Fits standard outlet boxes. Underwriters listed. **14¢**
C13329—Your Cost \$1.25
 10 for

Wall Plates
 (E) Pressed ripple design. Stainless steel. **10¢**
C13329—Your Cost

Power Cord and Plug
 (F) High quality 6-foot cord with sturdy plug. For replacement on sets, and appliances. **18¢**
C13285—Your Cost

Fitsall Iron Element
 (G) For most irons including Hot Point, G.E. and Sunbeam. Genuine India mica, wired with Nichrome ribbon wire. **49¢**
C13270—Your Cost

Cone Elements
 (H) For 110 volt electric heaters. **C13304—600 watt. 49¢**
Your Cost 72¢
C13305—1000 w. each

Insulated Staples
 (J) For holding inside lead-in and ground wires in place. No. 5. Size 1 1/2 x 3/8" long. **12¢**
C15950—Your Cost

Handle Plug
 (K) Made of soft rubber. For all appliances. **8¢**
C13301—Your Cost 75¢
 10 for

Cube Tap
 (L) Bakelite. 3 outlets from 1 plug. **10¢**
C13282—Your Cost 90¢
 10 for

Current Tap
 (M) Straight socket with 2 cap outlets. **15¢**
C13278—Your Cost

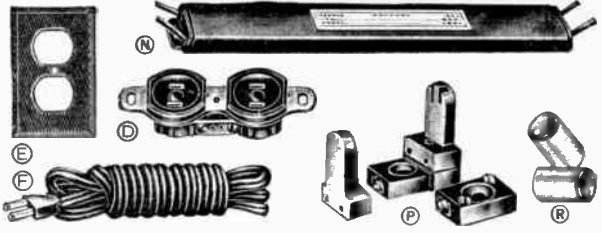

Fluorescent Ballasts

(N) High power factor units from 90 to 100%. Normal power factor units from 55 to 63%. All are Underwriters listed. For 105-125 v. 60 cyc. AC.

Stock No.	Type	Lamp Watts	Wt.	Each	Lots 10/ea.
Normal Power Factor					
C25616	15B	15	1 1/2 x 1 3/4 x 1 1/4	1	\$0.70 \$0.63
C25617	20B	20	1 3/4 x 1 3/4 x 1 1/4	1	.70 .63
C25618	30B	30	1 3/4 x 2 1/8 x 8 3/4	3	2.25 2.03
C25619	40B	40	1 3/4 x 2 1/8 x 8 3/4	3	2.25 2.03
C25620	220B	(2)20	1 1/2 x 1 1/2 x 6 1/4	2	1.30 1.17
High Power Factor					
C25614	30BLP	30	1 1/2 x 2 1/8 x 1 1/4	4	4.60 4.14
C25615	40BLP	40	1 1/2 x 2 1/8 x 1 1/4	4 1/2	4.60 4.14
C25605	40BL2	(2)40	1 1/2 x 2 1/8 x 1 1/4	5	4.65 4.19

Fluorescent Sockets

(P) For T-8 and T-12 lamps. Combination sockets include socket for starter. All are molded of durable heatproof plastic having a high insulating value. T17 sockets include one plain and one combination socket.

No.	Each
C13803—Comb. black	20c
C13804—Comb. white	22c
C13805—Plain black	12c
C13806—Plain white	14c
C13807—Starter only	12c
C13801—Comb. white for T-17 lamps. Per Pair	93c
C13808—Plain black for T-5 lamps. Per Pair	58c

Fluorescent Starter Switches

(R) **C13802—FS-5.** For 6" 4 W.; 9" 6-W. and 12" 8-W. lamps. **Your Cost 29¢**

C13810—FS-2. For 18" 15-W.; 24" 20-W. lamps. **Your Cost each 23¢**

C13811—FS-4. For 36" 30-W.; 48" 40-W. lamps. **Your Cost each 49¢**

C13820—FS-7. For 36" 65-W. lamps. **Your Cost each 49¢**

C13813—FS-6. For 60" 100-W. lamps. **C13827—FS-12.** For 12" 32-W. Circline. **Your Cost 29¢**

Automatic Starters

(R) Life time starter, removes defective lamp from circuit. Operates automatically when lamp is replaced.

C13812—FS-2NB. For 18" 15-W. or 24" 20-W. lamps. **Your Cost each 45¢**

C13814—FS-4NB. For 36" 30-W. or 48" 40-W. lamps. **Your Cost each 75¢**

C13815—FS-6NB. For 60" 100-W. lamps. **Your Cost each 75¢**

No-Blink Instant Starters

(R) Starter acts in one second or less. Eliminates blinking.

C13825—FS-2NA. For 18" 15-W. or 24" 20-W. lamps. **Your Cost each 39¢**

C13826—FS-4NA. For 36" 30-W. or 48" 40-W. lamps. **Your Cost 59¢**

C13828—FS-6NA. For 60" 100-W. lamps. **Your Cost 59¢**

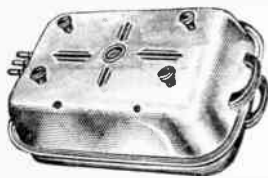

PRINCESS All-Chrome Broiler

Cooks quickly and efficiently. Holds and saves natural food flavors and vitamins. Minimum loss of valuable health-giving minerals. Dry-bakes potatoes and vegetables.

Polished Chromium finish for long lasting beauty. Smooth surfaces permit cleaning with but a whisk of a damp cloth—no rusting or corrosion. Mirror finish reflects random heat rays inside closed cover to realize an efficiency unparalleled in modern broiler design!

Shape and size permit the preparation of roasts, small fowl, steaks with a minimum of effort and time. Control permits cooking at 400 or 1000 watt heats for maximum economy. Temperature dial built into top section. Provided with vents for uniform air circulation. Heat resistant plastic handles and mounting feet fitted to both top and bottom sections for absolute safety when handling hot unit. Complete with Nickel finished Perma-welded one piece grill. Broiler overall size: 15 1/4" x 9 1/4" x 6 1/4". Operates on 115 volts AC-DC. Shpg. wt. 9 lbs. **C25401—Your Cost..... \$14.89**

Lots of 6, Each..... **\$13.35**
 Lots of 12, Each..... **12.84**
C13303—3 way cord and plug for Broiler. Your Cost..... 75c



GEM Waffle Iron

A waffle iron to satisfy the most discriminating eye. Superior design, construction, and efficient operation combine to make this one of the most economical to use, as well as one of the best values on the market.

Heavy Chromium plated for everlasting beauty. Circular one-piece, seamless molds. Entire set is finished with mirror smooth stain resisting metal. Easily cleaned, sanitary gleaming surface needs but the swish of a damp cloth to keep it new looking.

Uniform waffle thickness assured by expansion hinges and easily read built-in thermometer. Tells just when to put in the batter and when to turn off the iron to maintain a constant heat. One piece Chrome plated steel tray type base will not tip or mar table tops. Handles are mahogany finished wood, remain cool even after long periods of operation. Solid and safe internal construction. Fully Underwriters Listed. Heating elements are set in heavy insulating ceramic block. All internal wiring provided with shockproof asbestos insulation. Operates from 115 volts AC or DC. Shpg. wt. 8 lbs. **C25402—Your Cost..... \$7.95**

Lots of 6, Each..... **\$7.17**
 Lots of 12, Each..... **6.90**



PRINCESS Electric Stove

A truly portable electric stove for use in Summer Homes, Apartments, where space is limited or additional cooking facilities are required. Concentrated, even heat for quicker, cleaner and cooler cooking the year round.

One or two burners operating at 400, 660 or 750 watts heat is obtained by proper insertion of line plug. Sturdy one piece steel shell forms inverted dome type structure for great strength and rigidity. Heat is reflected upward by curved internal surfaces into the cooking area to effect greater economy of operation. Safe—fully Underwriters Approved. Internal wiring protected by heavy coating of asbestos.

Sides fitted with heat resistant black plastic handles. Table tops are protected by four feet made of the same material. Harmonizes with any color scheme. Top is in highly polished Chromium, the burners dark blue and the body finished in gray crackle enamel. For 110 v. AC-DC. Shpg. wt. 8 lbs. **C25400—Your Cost..... \$6.82**

Lots of 6, Each..... **\$6.11**
 Lots of 12, Each..... **5.88**
C13302—Two way cord and plug for Waffle Iron or Electric Stove. Your Cost..... 52c

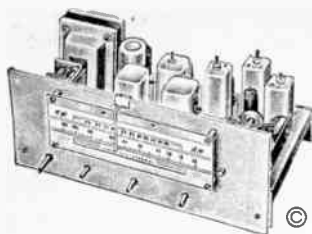

PACIFIC FM-AM Tuner

© An entirely new FM-AM tuner for the average pocket-book. Uses 11 miniature tubes, and rectifier, to achieve High Frequency performance usually found only in much larger and more expensive sets. Covers Broadcast band from 540 KC to 1750 KC and the new FM band from 88 MC to 108 MC.

FM section uses new ratio detector, AVC and IF coils wound on Polystyrene forms for highest gain and stability possible. Designed for use with standard 300 ohm transmission line and dipole antenna.

AM section is an advanced high fidelity super-heterodyne circuit incorporating a high gain stage of tuned RF, band expanding permeability tuned iron core IF coils and 10 KC filter to prevent interference from adjacent channels. For use with regular single wire broadcast antenna. Infinite impedance detector. Full AVC action.

Output is flat within 2 db from 30 to 15,000 cps, will match any amplifier input impedance. Provision for phono input at rear of chassis. Selection of FM, AM or Phono may be made at front panel switch. Tone control for use on FM, AM or phono to suit your individual taste in tone reproduction. Modern slide rule dial with but a single tuning control for both FM and AM. Built-in volume control, self contained power supply. Chassis is surfaced in attractive gray wrinkle finish, measures 13" long, 6" high, and 8" deep. Shpg. wt. 18½ lbs.

Model AF-11. Complete, ready to operate, with tubes, power cord and dial. Less amplifier and speaker.

C22494—Your Cost \$86.73



APPROVED ELECT. INST. CO.

FM Tuner

© FM tuner of moderate price but advanced engineering. Front end tuning is a patent-pending arrangement of three pairs of resonant tuned lines, large diameter for maximum skin conduction, curved on radius for continuous contact by rotating slides actuated by standard dial drive wheel, and mounted in ceramic. The lines have silver overlay as in the most costly Army-Navy radar tuners. The contact arms are also silver overlaid, on phosphor bronze, and are mounted on Lucite bars. The entire front end is of unit construction with floating mount in the heavy (16 gauge) cadmium-plated steel chassis. Microphonics are thus held to a minimum. Tuning is very stable; frequency drift is negligible after five minutes. Range is 88 to 108 mc. Impedance matches a 300-ohm dipole antenna.

Superheterodyne circuit with standard IF of 10.7 mc. IF transformers are the latest type iron-core with ceramic insulation, and provide a 150 kc band width for maximum FM fidelity. Sensitivity is excellent; only 10 microvolts are required for full limiting, assuring noise free reception. Output is full 2 volts rms at 500,000 ohms, for connection to the usual high-impedance phono input in either an AM radio receiver or an AF amplifier. Built in power supply is AC type, extremely well filtered; hum level is 70 db below average output.

Tubes: 6AG5 RF, 6J6 converter, two 6SH17 IF's, 6SH17 limiter, 6AL5 discriminator, 7Y4 rectifier. 6U5 tuning eye. Cabinet is hand-rubbed walnut veneer, 13" wide, 9¾" high, 10" deep. Sliderule dial, 6" pointer travel. Complete with tubes, for 115 volts, 60 cycle AC. Shpg. wt. 15 lbs.

C22491—Your Cost \$59.50

FM TUNERS AM



CONCORD FM Tuner

© An inexpensive "one-chassis" FM tuner to be attached to any broadcast radio receiver or P.A. amplifier for receiving FM programs in the new 88 to 108 megacycle band. Tone quality and volume is limited only by the performance of the broadcast receiver or P.A. amplifier with which the tuner is used. Affords the added pleasure of FM to those who already have AM radios. Foolproof, efficient and easy to attach. Small size, neat appearance. May be placed in record compartment of combination receivers. Has built in antenna for strong local reception plus connections for dipole. Has large (4"x6") illuminated clock-type dial with easy-to-read numerals.

Tubes: 12BE6 Converter, 12BA6 1st IF, 12BA6 2nd IF, 12AL5 Det., 35W4 Rect. Two controls, tuning and off-on. Cabinet is walnut veneer, 10½" wide, 5¾" deep, 6¾" high. Complete with tubes and instructions for the simple connection to broadcast-band receiver or amplifier. Shpg. wt. 8 lbs. For 115V AC or DC.

C22490—Your Cost, Each \$23.95

BROWNING

Model RJ-12 FM-AM Tuner

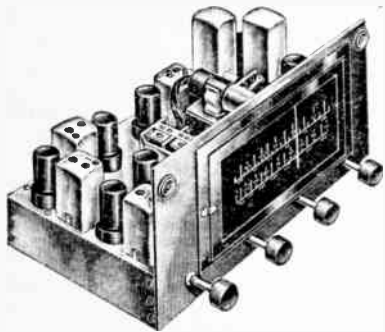

Designed for high fidelity, distortion free reception, high frequency FM band (87 to 109 MC) and AM standard broadcast band (540 to 1650 KC). Ideal tuner for use with high-quality amplifiers. Physical size makes it adaptable to special cabinets, drawers, shelves, racks, and "built-in" applications. Two entirely independent tuners are incorporated on one chassis to provide highest quality output. FM section con-

sists of one stage TRF; mixer stage with separate oscillator; operating at higher frequency—thus minimizing image interference; two stages IF; two-stage cascade limiter, insuring maximum noise rejection; and discriminator stage, delivers 0.5 volts RMS to channel selector switch. Input signal of 15 microvolts will cause complete limiting action. AM section is superheterodyne type and consists of: one stage TRF, to eliminate image responses; a mixer stage; a high gain IF stage; and a diode detector, which furnishes AVC voltage and .05 volts RMS audio to channel selector switch. Sensitivity of this section is one microvolt. Phonograph input is connected into channel selector switch. Controls: volume, channel selector switch, tuning, and "off-on" are on front panel; large slide rule dial. Phono input jack, audio output jack, connector for 300-ohm antenna lead-in wire, and power supply connectors are on the rear panel. Complete with tubes, dial escutcheon, walnut knobs, and instructions. Size: 7½"x13½"x9" deep. Shpg. wt. 17 lbs.

C22512—Less Power Supply. Your Cost \$143.90

BROWNING Model PF-12 Power Supply for above Tuner, 115-volt 60-cycle operation, complete with tube and line cord. Size: 6x3½"x8". Shpg. wt. 11 lbs.

C22513—Your Cost \$15.78

MEISSNER

AM-FM Tuner Model 9-1091

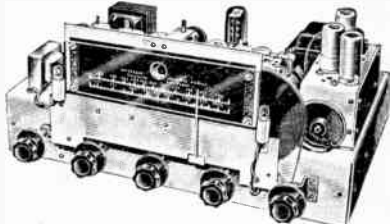

Designed for realistic high fidelity reception. Two separate tuners, power supply, AF preamplifier, all on one chassis. Frequency response ±2 db 30-15,000 cps. Treble control varies response at 10,000 cps from +12 to -14 db. Bass control provides 10 db boost at 40 cps. Volume control has

an automatic bass compensation circuit to match the bass characteristic of the human ear. AM coverage 527 to 1620 kc. FM coverage 88-108 mc.

Sensitivity is such that less than 10 microvolts are required to produce standard output. AM selectivity is variable to "Broad" for high fidelity or "Sharp" for selection between adjacent channel stations. AF output is 8 volts at high-impedance and .75 volts at 500-ohm output. Hum level is 60 db below output. Phono input terminals are provided so that the tuner and its amplifier may be used with a record player or changer. Any antenna with a single lead-in wire can be used for AM signals. The FM section is designed for use with standard FM antenna 300-ohm transmission line. Tube complement of the AM-FM tuner is: 9003 RF amplifier; 6BE6 oscillator-converter; 2—9003 IF amplifiers (456 kc); 6AL5 detector for the AM section. For the FM section; 6AG5 RF amplifier; 6C4 oscillator; 6AG5 converter 3—6AG5 IF amplifiers (10.7 mc/cycles), 2—9001 limiters; and 6AL5 detector. Two 6C4's are used for audio amplifiers, a 6U5/6G5 for tuning indicator and a 5Y3GT/G for rectifier.

Chassis is 16½"x10¼" (requires 1¼" additional between chassis and panel). Net weight 19½ lbs. Unit complete with tubes, escutcheon plate and slide rule dial 2x7½" opening. Dial calibration AM in kilocycles, FM in channel numbers (200 to 300). For 115 volts, 50-60 cycles, AC.

C22499—Your Cost \$147.00

C22498—Black wrinkle cabinet. Dimensions 18¼"x11¼"x9". Net weight 12 lbs.

Your Cost \$8.82

C22497—Black wrinkle cabinet panel only. Dimensions 18x8¾". Net weight 2½ lbs. Your Cost \$2.35

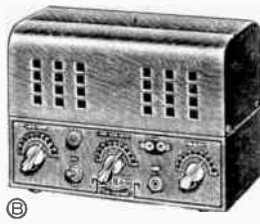
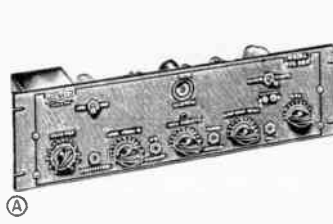

SONAR Model VFX 680 All Band Exciter

(A) Complete Narrow Band Frequency Modulated phone and CW exciter with built-in power supply. Oscillator operates from VFO to crystal control. By varying the VFX control, any type cut crystal becomes "rubberized."

VFO operates in the 160 meter band with frequency range from 1565 KC to 2000 KC. Variable frequency shift is from 30 KC on 80 meters to 480 KC on 6 meters. Frequency range covers the 80, 40, 20, 11, 10, 6, 2 meter bands as well as the new proposed 15 meter band. Power output 4 to 6 watts. Monitor circuits for CW and NBFM phone with output jacks on front panel. Deviation indicator is self-contained cathode ray tuning indicator. External relay control provided for remote operation. CW and break-in operation permitted on the same frequency without shutting off the oscillator.

Plug-in coils give two-band operation on one set of coils. 40-20 meter bands coil set supplied with exciter. 8 tube circuit including VR and rectifier. Any type high impedance crystal or dynamic microphone with output between -48 and -52 db may be used. Front panel finished in smooth gray baked enamel with red and white screening. Complete with tubes and one set of coils but less crystal. For use on 110-125 volts 50-60 cycle AC. Size 5 1/4 x 19 x 8 1/2". Shpg. wt. 30 lbs.

C21007—
Your Cost..... **\$87.45**
C10430—10 meter coil
C10431—15 meter coil
C10432—20 meter coil

C10433—40 meter coil.....
C10434—80 meter coil..... } **Each \$1.50**

SONAR Model XE-10 Narrow Band FM Exciter

(B) An ideal unit to convert any type transmitter in the 6, 10, or 11 meter bands for use on Narrow Band FM operation. These are the lowest frequencies allowed by the FCC for amateur use of FM. The exciter also has an output in the 40 meter band, using an 80 meter crystal.

Complete instructions for connection and use are furnished with the equipment. Easily connected into your crystal socket or the grid circuit of a VFO. Eliminates the use of speech amplifiers, modulator and their power supplies and permits the final to be used as a highly efficient class C stage. Increases the power output and reduces the input power consumption. Unit has 3 watts output at 7 Mc. Link couples to transmitter. Entire unit contained in a neat ventilated cabinet that makes a handsome addition to any Ham shack.

Any AM receiver can be used for reception by tuning slightly out of resonance, because the deviation is only 2 to 3 KC. Contains microphone amplifier, crystal oscillator, buffer modulator, and a 115 volt 60 cycle AC power supply. Modulation and tuning controls, transmit, receive toggle switch, pilot light, crystal socket, and microphone jack are mounted on the front panel. Tuning meter jack and the transmission line connector are mounted at rear of cabinet.

Unit is complete with tubes, but less crystals. In gray cabinet 9 3/4 x 7 x 5". Shpg. wt. 12 lbs.

C21006—
Your Cost..... **\$39.45**

SONAR Model MB-611 Transmitter

(C) Small compact transmitter for 10 and 11 meter operation. Uses any type power supply. Can be installed in any vehicle, boat or airplane. Also used for fixed station, or as driver for high power final. Employs exclusive Sonar Phase Modulator with direct crystal control. VFO may be used in place of Crystal. Input for hi-impedance crystal or dynamic mike having output of -52 db or better. Tuning condensers are the screw-driver set type, with locking nuts for stable operation. Dual indicator for RF tuning and deviation. Frequency deviation adjustable from 2 to 3 KC. Will match any type antenna or transmission line. Power output ap-

prox. 22.5 watts. Supplied with 10 and 11 meter outputs. Available with 6 meter output. Requires power supply of between 250 and 600 volts DC at 100 mills from vibrator, dynamotor, or AC supply. Power consumption is 2.6 amps in Stand-by and from 10 to 20 amps in Transmit from any standard 6 volt battery. In gray case 10 1/4 x 7 x 5". Shpg. wt. 20 lbs. Complete with tubes but less crystal and power supply. Also available for 6 meter operation on special order.

C21019—
Your Cost..... **\$72.45**

MILLEN 60-Watt Transmitter-Exciter

(D) For standard rack. Requires up to 750v at 250 ma. -45v and 6.3v at 1.8 amps. Osc. is Tri-tet for 2x or 4x crystal freq., or by short-circuiting cathode tank, output is fundamental. Drives 807 which is either straight amplifier or doubler. Therefore several possible combinations of coils and crystals produce same output, and 25 to 50 or more watts can be had in 4 bands by proper choice of crystal freq. The 0-200 ma meter may be switched to read plate current of either stage.

Shpg. wt. 15 lbs. Milten No. 90800, with 10 meter coils, less tubes, and crystals.

C21021—
Your Cost..... **\$42.50**

Band	Cathode Coil	Your Cost	Plate Coil	Your Cost
160	C9950	90¢ Each	C9953	\$1.25 Each
80	C9951		C9954	
40	C9952		C9955	
20	Not Used		C9956	
10	Not Used			

New MEISSNER Signal Shifter—ECO or Xtal

(E) 6V6 osc. 807 doubler-amp. Turret band change. Eye-tube key and tuning indicator. Stabilized osc. screen voltage, 6 watts output. Vernier dials. Couples to most any circuit. Signal Shifter in cabinet 13 1/2 x 13 1/2 x 8 3/4", with tubes (including VR), less power supply sub-chassis, less coils. Shpg. wt. approx. 23 lbs.

Power supply sub-chassis, with two 5Y3's, for 115v, 60 cy. Shpg. wt. approx. 15 lbs.

C21022—
Your Cost..... **\$13.00**

Stock No.	Coil Strip	Stock No.	Coil Strip
C10389	80 meters	C10392	15 meters
C10390	40 meters	C10393	10,11 meters
C10391	20 meters	C10394	6 meters

Shpg. wt. 2 lbs. Each..... **\$4.00**

STANCOR ST-202-A 125-Watt Transmitter Kit

(F) Build your own compact desk-type transmitter to cover the 80, 40, 20, 15, 11, and 10 meter bands, crystal controlled. CW, but AM or FM easily added. You get cabinet with built-in chassis, marked panel and bottom plate, plus all circuit and construction components. 115v, 60 cy power supply furnishes 350 vdc, 1000 vdc, variable bias, and filament voltages including taps for your choice of PA tubes. You even get a prefabricated cabled harness for neat under-chassis appearance. All phases of construction and operation are fully covered by detailed instruction manual. The only extras needed are ma meter, 5 tub's, crystals, and a set of standard PA tank-coil plug-ins.

Novel band-switching exciter circuit with band-switch coil assembly and one tuning capacitor. Inter and intra-band flexibility with extreme simplicity of adjustment and control. Adjustable link coil antenna coupling. Simultaneous screen keying of both exciter tubes for clean signals. Break-in operation. For PA, you can choose a 35T, 35TG, HK5-1, 551-1, 811, or 812. (Wide-range neutralizer provided.)

Uses Barker and Williamson 150 watt var. link coils listed elsewhere in this catalog. Cabinet 14 1/2 x 9 x 13 1/2". Shpg. wt. 55 lbs.

C21020—
Your Cost..... **\$92.80**



SPERTI Two-Way Hand-Held Radio



Operates on 144-148 Mc (2 Meter band). Not surplus equipment, but a brand new exclusive design. Only high quality, new components are used anywhere in the construction. Ideal for transmitter hunts, field days, ham fests, emergency work, pleasure boating, flying or racing.

Excellent results obtained during antenna adjustments and tests by two-way contact between field-strength measuring equipment and antenna positions.

May be used as an auxiliary or emergency transmitter. May also be used as a complete permanent fixed station. Test result: 12 mile line-of-sight communication. Average performance 3 miles over flat or slightly rolling country.

40 hours intermittent B-battery life. Quick change. Instant-starting filaments save A batteries (two #2 flashlight cells).

Engineered for performance, designed for efficiency and priced for competition. Maximum performance in the smallest possible size and weight. Good for boats. Push-to-talk. Instantaneous break-in. Set at factory within band limits, stays in band unless tampered with. Slide-rule dial. Tuning can be locked. Retractable folding dipole antenna. Connect to a high antenna to increase coverage enormously. Stable oscillator and receiver, negligible shift. Size 10x3x2". Shpg. wt. 5 lbs.

C22450—With tubes, less batteries, **Your Cost** **\$33.81**
C20627—B Bat. (2 required). Each **\$1.88**

HY-Q 75 Xmitter Kit For 1 1/4 and 2 Meters

Linear oscillator, 135 to 250 mc. 14 watts CW, 11 W. phone. Chart for quick location of ham bands, no cut and try. Easily assembled. Fancy plumbing and tricky parts prefabricated. Micrometric tuning by adjustable lead screw. Silver plated tank circuit, silver-plated multi-ringer contacts on precision machined shorting bar. Contains special RF chokes and long path insulators. Quick band

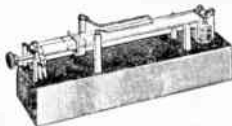

change. Pictorial wiring diagram and instruction manual with each kit. Less tube.

C21002—Kit, **Your Cost** **\$9.95**
C21001—Assembled, **\$11.95**
C24747—HY-75A tube **3.95**

BUD 75-Watt Plug-In Coils



All coils are air-wound with enameled copper wire and mount in 5-prong tube sockets. The convenient ceramic mounting base keeps the coil a safe distance from the chassis when the coil socket is mounted on the chassis. Center link coils have fixed center link with main winding center tapped. End link coils have fixed end link and are not center tapped. Variable link coils have adjustable center link with main winding center tapped.

Center Link	End Vari.	Cap.	Your Mfd	Cost
C10635	C10641	C10603	80M	75 \$1.32
C10636	C10642	C10604	40M	50 1.32
C10637	C10643	C10605	20M	33 1.32
C10646	C10647	C10649	15M	33 1.32
C10638	C10644	C10606	10M	28 1.29
C10639	C10645	5M	18	1.08

‡21 mmfd. for variable link coil.

▲▲▲▲▲ NOTE ▲▲▲▲▲
 ▲ Refer to page 137 for a complete listing of Barker and Williamson transmitting coils and turrets from 75 watts to 1 KW. ▲

JOHNSON Spring Clip



For inductor coils of all kinds. Will take wire from #20 to #10 gauge. Lock screw adjustment. **C16749**—Each **7¢**

Heat Radiating Grid and Plate Caps



Use at terminals of x'mitting tubes. Protects glass.
C14377—For HK-24 **35¢ea.**
C14378—For 35-T, HK-54 **35¢ea.**
C14381—For 100-T, 807 **59¢ea.**
C14388—For 866, T-125

AMPHENOL Miniature Polystyrene Forms and Sockets



Undrilled. 3/8" dia., 1 1/2" long. Permanent mounting form has raised hole in center for self tapping screw. Sockets for plug-in types also fit Hytron Bantam Jr. tubes.

C11577—Permanent Mtg. Your Cost **10¢**
C9628—5 Prong Form **28¢**
C13161—5 Contact Socket **24¢**
C9629—6 Prong Form **28¢**
C13162—6 Contact Socket **24¢**

NATIONAL Grid Clips



Type A. Easily removed. Tinned grip end for soldering.

No. Type Tubes Dia. Each
C14434 Stand. Glass 3/8" 3c
C14565 Metal (octal) 1 1/2" 3c
C14441 X'mitting* 9/8" 6c
 *—866, T20, 809, 812, etc.
C14598—Type B. Ceramic safety grip 3/8" dia. for 866, T20, 809, 812, etc.
Your Cost Each **24¢**
C14599—Ceramic as above but 3/8" for 807, etc. **21c**

NATIONAL Hi-Frequency Coils

High Q permeability tuned RF coils, tune with capacities from 100 to 10 micro-micro farads. Inductive winding replaceable. AR-2 tunes from 75mc to 220mc. AR-5 tunes from 37mc to 110mc.
C14382—AR-2 Your Cost. **\$1.71**
C14383—AR-5 Your Cost. **1.46**

Hi-Frequency Coil Form

XR-50 permeability tuned coil form. Winding length 1 1/2", dia. 1 1/2". Iron slug 3/8" dia. x 1/2" long.
C14384—Your Cost **\$1.01**

AMATEUR RADIO EQUIPMENT

RME VHF-A-152 Converter

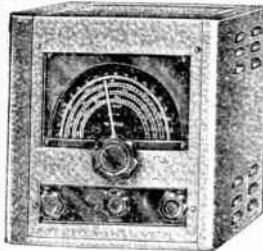

For 2, 6 and 10 Meters, 28-29.7, 50-54, 144-148 Mc. Wide-range receiving facilities at low cost and with minimum equipment. Uses the extremely efficient double-conversion system when connected to your receiver. Image rejection ratio 54 db. Stability at 50 mc is better than in most receivers at 5 mc because of new engineering design, VR-150 regulation, and temp. stabilization in VHF oscillator circuits. Low noise level. Sensitivity 2 microvolts on all bands. Miniature tubes. Line-up is: 6AK5 RF, 6AU6 mixer, 6J6 oscillator. Power supply uses 5Y3GT and VR-150.

Tuning dial is black with raised white numerals. Scale is 7" dia. with wide spreading of the calibrations. Separate scale for each of the 3 bands, calibrated in Mc. Entire dial is illuminated indirectly for maximum readability and minimum glare. The tuning mechanism is an all-gear planetary drive with no cables, pulleys, or levers. "Out-In" switch transfers the receiver from the converter to antenna. Converter has provisions for 4 separate antennas, one for the receiver frequencies, and separate input circuits for each of the converter ranges, each designed especially for a particular VHF range. Shielded cable is furnished for connection to the receiver. Complete with tubes, ready for operation on 110 120 volt, 50/60 cycles.

C21013—Model VHF-A-152 Converter. **Your Cost** **\$86.60**

RME DB-22A Preselector 540 Kc to 44 Mc

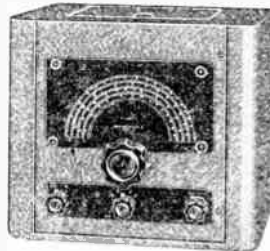

New, completely redesigned for greater efficiency. Adds 3 tuned circuits and 2 6AB6 miniature tubes ahead of the RF stage in your present receiver. Gives tremendous increase in gain, selectivity, and signal-to-noise ratio. Average overall gain is 30 db throughout the range. Image ratio is 50 db at 28 mc. Completely solves the problem of maintaining contact on 10 meters. Complete with power supply using a 6X4 rectifier. Input circuit for matched doublet plus a single wire to ground, permits high-gain matching to any antenna. Output for 150-350 ohms, direct connection to antenna posts of receiver. Antenna

change-over switch on panel couples receiver directly to antenna when unit is not being used. Range is covered in four bands. Smooth planetary tuning mechanism with plenty of drive ratio. 7" dia. dial scale, dull black background, white numerals, indirectly illuminated. Gain control independent of receiver.

Housed in an attractive, clean-cut cabinet styled in the same lines and two tone gray crackle finish as the RME 45 Receiver. Complete with tubes and output connecting cable, ready for operation from 110/120 volt, 50 60 cycle source. Dimensions: 11" high, 12" wide, 11" deep. Shpg. wt. 21 lbs.

C21012—Your Cost **\$66.00**

SPECIAL VALUE! Smooth Coil Forms



Blank Bakelite forms only, for winding coils to your own specifications.
C10060—4 prong
C10061—5 prong
C10062—6 prong
Your Cost Each **21¢**
 Any Above Type **21¢**

MILLEN Plate Caps



Steatite covered cap, for transmitting tubes.
 Type 866 etc.
 Millen -36001.
C8055—Your Cost Each **21¢**
C8056—36002, 3/8" **21c**
 #36011, Extra tight. Snap action top button to release grip.
C8052—3/8" dia.
Your Cost Each **60c**
 #36012, snap action as above,
C8053—3/8" dia. **60c**

Reliance Ribbed Coil Forms



These coil forms are of high quality low-loss Bakelite, and are ribbed for air-spaced winding. They have knurled flanges for facility in handling, and grooves for wave band index. Eight ribs.

Medium Size

Undrilled, 1 3/8" dia. 3 3/8" high.
C9630—4-Prong } Each **35¢**
C9631—5-Prong }
C9632—6-Prong Each **38c**

Small Size

Undrilled, 1 1/8" dia. 2 1/4" high.
C9988—4 Prong Each **23c**
C9989—5-Prong } Each **25¢**
C9990—6-Prong }

NATIONAL • SUPREME RME Equipment

NATIONAL NC-57 Receiver

Go "International with National." The latest product of National's long-standing reputation in the communications field. Provides reception of Phone and CW signals over the entire frequency spectrum of 550 KC to 56 MC in five bands. Features a built-in power supply, heavy duty PM speaker and maximum flexibility of operation on all bands thru use of front panel mounted controls.

RF amplifier, converter, and CW oscillator circuits include voltage regulation to insure a high order of stability on both CW and Phone reception. Nine tubes including voltage regulator and rectifier. A separate band spread dial, provides pin-point sharp tuning and accurate calibration on all bands facilitates tuning to any desired frequency—quickly and easily.

Antenna terminals provide for connecting single wire, doublet, or co-ax antenna lead-in, and a socket is provided for connecting an external "S" meter.

Housed in an attractive modern cabinet finished in smooth gray enamel, 16 $\frac{1}{2}$ " wide, 11 $\frac{3}{4}$ " deep, 8 $\frac{3}{4}$ " high. Operates on 105-120 volts, 50-60 cycles AC, with a socket at the rear provided to permit battery operation and/or the connection of an external relay or B plus switch. Shpg. wt. 33 lbs. Complete with tubes.

C21266—
Your Cost **\$89.50**

SUPREME Model AF-100 Transmitter

- ★ AM—NBFM—CW—ICW
- ★ Complete Metering
- ★ Inter-Lock Protection
- ★ Single Dial Tuning of Exciter and Multiplier

Complete, compact and inexpensive transmitter for desk top operation. Covers all the frequencies from 10 thru 80 meters. CW, ICW, AM or NBFM available at the flip of a switch. An exceptionally stable VFO is followed by slug-tuned buffer and doubler stages, ganged together with the VFO. Provision made for selection of two predetermined crystal frequencies. Bandswitching throughout except in output stage where plug in coils are used. NBFM deviation adjustable from 0 to plus and minus 75 KC.

Metering of all essential circuits plus pilot light indicators give operating characteristics and condition at all times. Oscillator keying for break-in operation. Antenna relay provided with extra contacts for receiver disabling during transmission. Microphone and key jacks readily accessible at the front panel. Operator is protected against high-voltage shock by automatic interlock switches when the cabinet is opened. Twenty tubes used, including voltage regulators and rectifiers. Final uses a 3D23 and the modulator a pair of 807's. Operates from power source of 110-117 volts at 50-60 cycles. Power consumption 325 watts. Size 29 $\frac{3}{4}$ " x 11 $\frac{3}{4}$ " x 18 $\frac{3}{4}$ ". Shpg. wt. 195 lbs. Complete with tubes and coils but less key, mike and crystals.

C21025—
Your Cost **\$550.00**

RME-84 Receiver

New low cost superhet with complete coverage from 540 kc through 44 mc. Design and construction are in accordance with RME's past standards. No "low priced, average components" are used anywhere in this set. There is no omission of controls necessary for the reception of either phone or CW signals. Power supply built in for 115 volt, 60 cycle AC power source, and a socket is provided for battery connection, made feasible by the use of low-drain 10octal tubes.

Tube lineup is: 7B7 RF, 7S7 converter, two 7B7 1F's, 7K7 det./1st AF, 6G6G output, 7K7 noise limiter/BFO, 5Y3GT rectifier. 10octals were chosen not only for their low drain, but also because of their efficiency at high frequencies.

Bandspread on any setting of the main dial is provided by a vernier dial which has 200 divisions on the edge of a 3 $\frac{1}{2}$ " diameter disc. Scale makes five complete revolutions for the 180° rotation of the tuning capacitor. Tuning mechanism is a planetary-drive system, spring-loaded to eliminate all back lash. The overall calibration is held to within one-tenth of one per cent. Complete with tubes and self-contained speaker. 18x9 $\frac{3}{8}$ "x9 $\frac{3}{8}$ ". Shpg. wt. 35 lbs.

C21011—
Your Cost **\$98.70**

RME-45 Receiver

The outgrowth of a long series of fine instruments, built for practical, all-coverage phone and CW radio reception. One of the outstanding features is "CAL-O-MATIC" automatic tuning and calibration of the scale, accomplished by an ingenious mechanism developed by RME. Once the receiver leaves the test room absolutely no further calibration adjustments need be made. In consequence, all calibration points, main and bandspread, are determined automatically as tuning proceeds. No dials to reset, no padders to be readjusted, and no recheck points to observe. A single, smooth as velvet, dial is used for tuning, and the circular bandspread scale is geared 5:1 to the main scale. All controls streamlined, handy and convenient. The band coverage is 550 kc to 33 mc in six bands with overlap. Tube lineup is: 7B7 RF, 7J7 converter, two 7B7 1F's, 7B6 det. and BFO, 7C7 1st AF, 7C5 output, 7A6 automatic noise limiter, 80 rectifier. 10octals used because of their low drain, high efficiency, and long life. The use of finest components and a sturdy double-space tuning capacitor in the oscillator section hold frequency drift to an absolute minimum. Both relay control and break-in connections are provided at the rear of the chassis. 5-position crystal selectivity switch. DB meter calibrated in steps of 6 db per B reading beginning at zero on up to 48 db for R9 and up to 96 db (48 db above R9).

Size: 22 $\frac{1}{2}$ " L., 12" W., 11" H. Shpg. wt. 56 lbs. Complete with tubes and Speaker in Matching Cabinet.

C21010—
Your Cost **\$198.70**

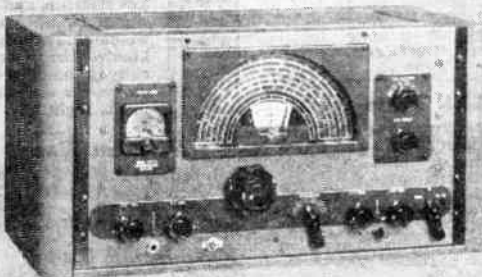
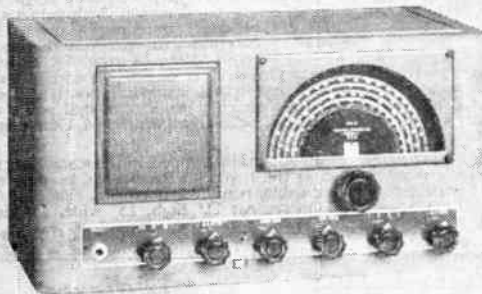
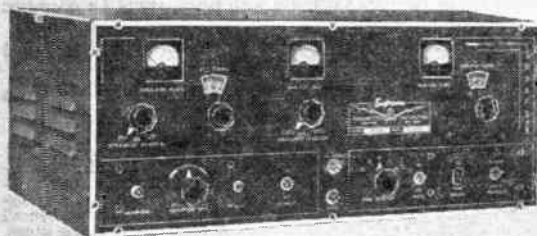
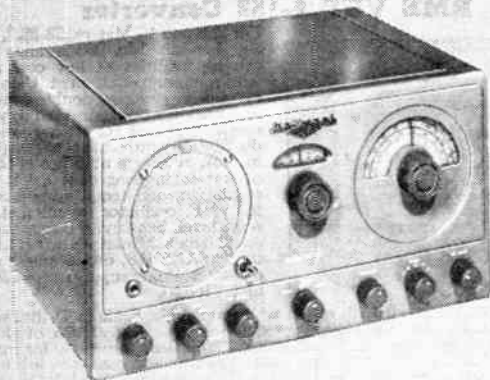

HAMMARLUND HQ-129-X

This is truly the Hams receiver with the professional touch. Long years of Hammarlund engineering have resulted in an extremely fine tuning unit. Antenna effects at entirely different frequencies are quickly adjusted by the antenna compensator, noise is kept to a low level compared with the desired signal.

Main tuning dial is accurately calibrated for each of the six bands. These bands are broken down as follows: 540-1320 kc., 1320-3200 kc., 3200-5700 kc., 5700-10,000 kc., 10-18 mc., and 18-31 mc. In addition to the calibrated band spread dial which covers four amateur bands there is also an arbitrary scale provided for any bands becoming available at a later date.

Tube line-up: 6SS7 RF amplifier, 6K8 converter, 6SS7 first IF amplifier, 6SS7 second IF amplifier, 6SS7 third IF amplifier, 6H6 second detector, AVC and noise limiter, 6SN7GT/G first AF and S-meter, 6V6GT/G audio output, 6SJ7 beat frequency oscillator, 5U4G full wave rectifier and OC3/VR105 voltage regulator. Antenna input impedance of 400 ohms provides for the use of single wire antenna or balanced transmission line. Audio output of approximately 3 watts, undistorted. S-meter mounted between the main dial and band spread dial calibrated 1 to 9 in steps of approximately 6 DB. Six position Crystal filter. New series type noise limiter provides better limiting and has less effect on modulation. 115 volts, 60 cycles. 13 $\frac{1}{2}$ " x 20 $\frac{1}{2}$ " x 11 $\frac{1}{4}$ ". Shipping weight 52 lbs. Complete with tubes, less speaker.

C21035—
Your Cost **\$177.30**
C21036— Matching Speaker in Cabinet **\$11.85**

HAMMARLUND SUPER-PRO

For the amateur or commercial operator who wants the best available performance in communications receivers, the Super-Pro is an outstanding selection in the field of fine receivers. Selectivity, sensitivity, signal-to-noise and signal-to-image values obtainable in this receiver are due to 2 stages of tuned RF amplification and 3 stages of IF amplification. The IF amplifier features variable band-width which is controllable from the panel. The crystal filter circuit, patented by Hammarlund, has 6 switch positions: 3 for phone reception, two for CW and one for "off." AVC is applied to the 2 RF stages and also to two of the IF amplifiers.

Tuning range is 540 KC to 30 mc., in five bands, the 3 highest of which have bandspread provided on an arbitrary scale of 100 divisions. Model SP-400-SX covers 1.25 to 40 mc. and has bandspread on all five bands. The S meter on these receivers is calibrated from 1 to 9 at approx. 9 db per step, with external adjustment. Separate heavy duty power supply, standard model, operates on 115 v., 60 cycle a.c.

Model SPS-400-X, complete with tubes, power supply, and speaker in matching cabinet.

C21037—
Your Cost **\$398.25**

HAMMARLUND Four-11 Modulator

Designed especially for use with the new Hammarlund Model Four-20 transmitter. The output impedance is 8,000 ohms. The push-pull audio output stage is capable of delivering eleven watts of power output at less than five per cent distortion.

Careful design has resulted in an audio response that fits the needs of amateurs who are particularly interested in clear crisp speech that will pierce overcrowded and terrifically QRMD bands. Substantially flat between 200 and 3000 cycles. Quality as well as conservatively rated parts are used throughout. If it is desired to increase power at a later date, this modulator may be used as a very efficient driver unit.

Modulator and transmitter below are in cabinets similar in appearance and size. The front panel contains a standard microphone jack, gain control on-off switch, pilot light and convenient fuse outlet. The input impedance is suitable for any high impedance microphone. Tube line-up: 6SL7GT first and second audio amplifier, 60S phase inverter, 7C5LT's in push-pull audio output and a 5U4GT rectifier. Size: 8 $\frac{1}{2}$ " x 15 $\frac{1}{4}$ " x 9 $\frac{1}{2}$ ". Shipping wt. 45 lbs. Power source 105-120 volts, 50-60 cycles A.C. Complete with tubes.

C21048—
Your Cost **\$72.50**

HAMMARLUND Model Four-20 Transmitter

Complete self-contained crystal controlled CW unit designed especially for the radio amateur. Conservative output of twenty watts available on the 3.5-7-14 and 28 MC amateur bands. 3.5 MC crystals only are necessary as a series of doubler tubes and band switching provide output in the bands mentioned. Plug-in coils used in the plate circuit of the power amplifier stage only. An output coupling arrangement with an adjustable tap is a new feature on these plug-in coils. Any impedance between 50 and 600 ohms may be matched to the transmitter. A small high-speed relay is built into the unit to provide for excellent telegraph keying. If phone operation is anticipated the Hammarlund Four-11 modulator described above, provides an excellent companion unit. MONO-sequence tuning enables the operator to tune four circuits to four different but harmonically related frequencies by means of a single control. The stages are sharply tuned, resulting in highly efficient circuits. A constant load is kept on the oscillator stage at all times through the use of a special resistor net work. The front panel includes a milliammeter and switching arrangement so that any of the RF tubes may be metered. Tube line-up: 7C5LT oscillator, 3-7C5LT's multipliers, 807 power amplifier and 5U4G rectifier. Size: approximately 8 $\frac{1}{2}$ " x 15 $\frac{1}{4}$ " x 9 $\frac{1}{4}$ ". Shipping wt. 35 lbs. Power consumption approximately 150 watts at 110-120 volts, 50-60 cycles A.C. Complete with tubes and ten meter output coil, but less crystal.

C21049—
Your Cost **\$120.00**
C9967— 20 meter output coil **\$2.70**
C9968— 10 meter output coil **2.70**
C9969— 80 meter output coil **2.70**

Hammarlund Receivers • Transmitters

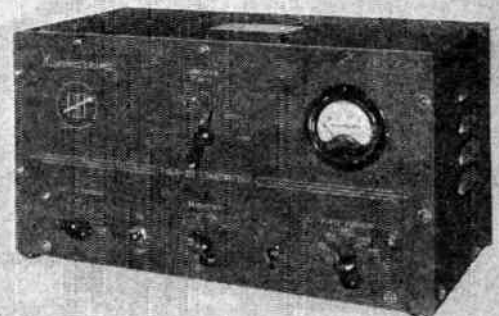
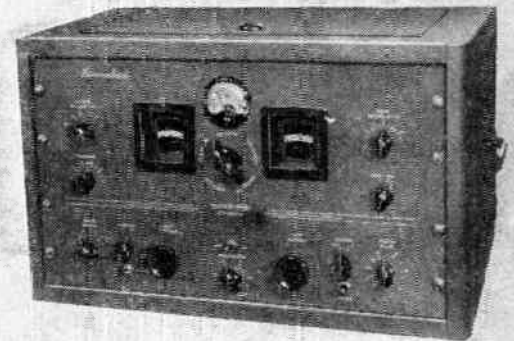
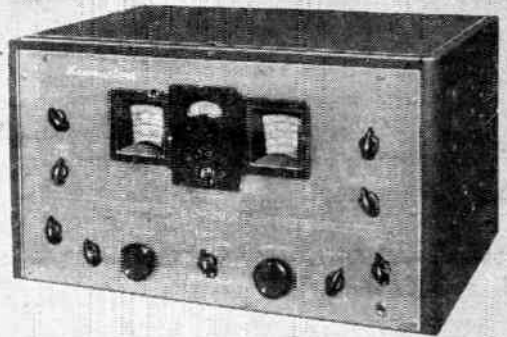

PERFECT MERCHANDISE • PROMPT SHIPMENT • PERSONAL SERVICE

hallicrafters

Communications Receivers

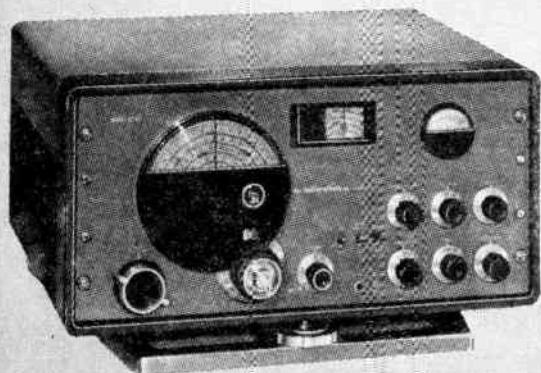
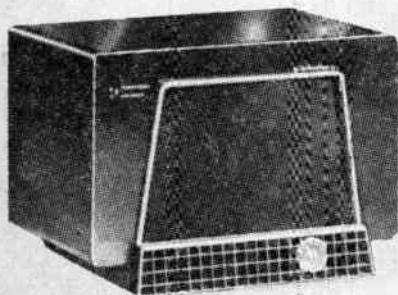
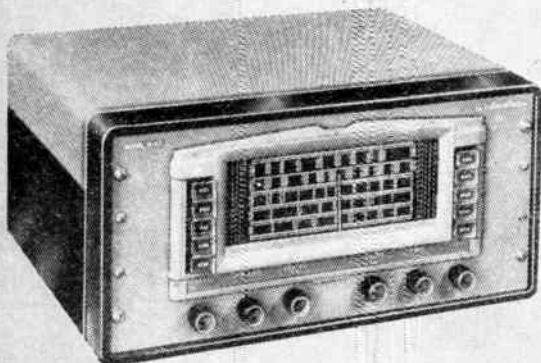

HALLICRAFTERS Model S-38

This new Hallicrafters Model S-38 is the finest receiver value ever offered in the low price field. The unusually fine styling makes this an ideal receiver for use in any room in the home. In addition its super-sensitivity makes it an excellent receiver for communications service.

Four bands are covered: 540 to 1,680 KC, 1,650 to 5,200 KC, 4,750 to 15,000 KC and 13,000 to 32,400 KC. The main dial is calibrated in megacycles. All controls are clearly marked and include the following: Noise Limiter, Band Switch, BFO, BFO Pitch, Speaker/Phone Switch and Standby Switch. Headphone jacks and antenna terminals are provided at the rear of the cabinet. Steel cabinet is finished in satin gray, and the speaker grill in the cabinet top is of airodized steel. 1.6 watts of audio output is available which is more than ample for all receiver requirements.

Electrical bandspread dial permits separation of stations for communication or station logging purposes. Tubes required: 12SA7 Converter, 12SK7 1F Amplifier, 12SQ7 BFO-Automatic Noise Limiter, 12SQ7 2nd Detector-AVC-1st Audio Amplifier, 35L6GT 2nd Audio Amplifier and a 35Z5GT rectifier. Operates on 105-120 volts, 40-60 cycles AC or 105-120 volts DC. May be used on 220-250 volts AC or DC with the 220-volt line cord converter listed below. Receiver includes built-in FM dynamic speaker. Overall size: 12 $\frac{1}{4}$ " wide, 7 $\frac{1}{4}$ " high, 8 $\frac{3}{8}$ " deep. Shipping wt. 14 lbs.

C21081—Model S-38 Receiver, with tubes. **\$47.50**
Your Cost.....
C5245—220-volt Line Cord Converter. **Your Cost**.....**\$1.41**

HALLICRAFTERS S-47

An ultra-new radio receiver designed to fill a long-felt need. Numerous applications in the home, schools, offices and public institutions where a superior installation is needed. Overall frequency coverage is from 535 to 1,720 KC, 5.9 to 18.2 MC, band spread tuning for Foreign reception of 9 to 12 MC, 15 to 18 MC, plus new FM Band of 88 to 108 MC. Wide vision slide rule dial accurately calibrated for close tuning. Five push buttons each for FM and AM tuning. Fourteen tubes plus rectifier.

Output stage uses two 6V6GT's, provides 12 watts of audio. AM response flat from 30 to 7,500 cps. FM flat from 30 to 15,000 cps. Separate bass and treble tone controls. Phono connection at the rear of chassis. Automatic Frequency Control "locks-in" receiver to FM station selected—assures minimum drift and maximum accuracy in tuning. "Airodized" steel top swings open on full length hinge. Receiver designed for use on 105-125 volts, 50-60 cycles AC. Any speaker with impedance of 500-600 ohms, such as R-42 shown below, may be used. 20" wide, 10 $\frac{1}{4}$ " high, 18" deep. Shipping weight 65 lbs.

C21067—Model S-47 with tubes. **\$200.00**
Your Cost.....
C21068—Model S-47C same as above but less cabinet. **\$189.50**
Your Cost.....

HALLICRAFTERS SX-42

In a new receiver that is really new, Hallicrafters sets a new high standard in performance and mechanical design. AM signals may be received over the entire range of the receiver; FM signals on the two bands covering 27 to 110 mc. High fidelity reception is assured by the essentially flat audio response, 60 to 15,000 cycles, and an undistorted output of 8 watts.

Controls of the receiver are in logical order for maximum convenience. Color coding of controls simplifies the problem of general family usage. Small red dots indicate settings for standard broadcast; green dots are used for FM. The main tuning knob has a precision vernier scale behind a small window in the main dial housing. The main tuning dial is calibrated in megacycles and is marked for the new FM band. The bandspread dial is calibrated for the 3.5, 7, 14, 28 and 50 mc. amateur bands. An additional scale is provided for logging. The small locking knob mounted coaxially with the main and bandspread tuning knobs permits either of the two tuning knobs to be rotated while the other is held in place.

Circuit features of the receiver are the split-stator tuning condenser used on the 3 higher frequency bands, making possible high stage gain, 6-position crystal filter and phase control, all-range BFO for CW reception, and the dual IF amplifier system which is automatically switched from 455 kc. to 10.7 mc. as the band selector reaches the higher frequency bands. Antenna terminals are for either single-wire (broadcast band) or doublet antenna. The audio system has output impedances of 500 and 5000 ohms. A phone jack is supplied on the front panel; a connector is on the rear of the chassis for phonograph pickup input. Miniature tubes, temperature compensated oscillator, two stages of RF amplification and two limiter stages produce superior performance at VHF. The circuit includes 15 tubes. An interesting accessory to the receiver is an adjustable base with which the receiver may be tilted to meet the "eye angle" and thus increase ease and accuracy of dial settings.

HALLICRAFTERS Matching Speaker

The R-42 Speaker (illustrated) represents one of the greatest innovations in speaker design in recent years. Heretofore, base reflex reproduction has been available only in large, space consuming cabinet speakers. This is the first speaker of its size to offer the wide range fidelity of bass reflex. Highly functional design has resulted in the fine performing, smart appearing speaker unit which may be used with any other receiver having 500/600 ohm output terminals. A switch is available on the speaker cabinet for switching from high fidelity to communications reception.

C21070—SX-42 Receiver, less speaker and base. **\$275.00**
Your Cost.....
C21069—SX-42U Receiver. Same as SX-42 but for operation on 110, 130, 150, 220, or 250 volts, 60 cycle AC. **Each**.....**\$287.50**
C21072—R-42 Bass Reflex Speaker, Table Type. **Each**.....**29.50**
C21071—B-42 Adjustable Base. **Each**.....**7.50**

HALLICRAFTER "Skyrider" Panoramic Adaptor

- ★ Avoid QRM
- ★ Spot Replies to Your CQ's
- ★ See What You Hear!

The Hallcrafters "Skyrider" Panoramic Adaptor enables you to see holes in busy bands as well as the signal characteristics of your own and other stations. Helps locate your sked and avoid QRM. Locates stations whose exact frequencies are not known. Provides instantaneous signal strength (S) meter readings for CW and Phone. Assists in making adjustments of transmitters and antennas. Indicates modulation percentage, frequency deviation, FM signals, audio distortion of carrier, carrier shift and splatter, spurious parasites, carrier hum level, key clicks, noise and frequency drift of your own as well as other transmitters.

Easy, simple connections to all receivers with an IF frequency of from 450 to 470 KC. Contains four simple operating controls and does not affect the operation of your receiver. Clear sharp panoramic picture is produced on self-contained cathode ray tube even in normally lighted room.

In sturdy black wrinkle finished steel cabinet, with high quality components assuring long trouble-free life. 11x9 $\frac{1}{2}$ x6 $\frac{1}{2}$ ". Complete with operating instructions, tubes and connecting leads. Shpg. wt. 16 lbs.

C21000—
Your Cost..... **\$49.50**

HALLICRAFTERS HT-18 Exciter

Directly Calibrated Variable Master Oscillator

This completely new exciter unit is the hottest item available for the modern amateur. A "must" for modernizing your transmitter. Power output from 4.5 watts at 3.5 MC to not less than 2.5 watts at 29.7 MC. Dial is directly calibrated in seven ranges to all the amateur bands from 3.5 to 29.7 MC. Narrow Band FM available on all ranges. Built-in pre-amplifier for high impedance crystal or dynamic mikes. Provision made for oscillator keying in break-in operation. Three crystal sockets provided for spot frequency operation. Tuning is extremely easy, overall stability is excellent. Drift is negligible. FM deviation plus and minus 1200 cps on all frequencies. Audio frequency response flat from 100 to 5000 cps. Check switch for beating oscillator against incoming signals without putting entire transmitter on the air. Panel controls include tuning, band selector, operation selector, deviation selector, On/Off AC, On/Off plate, and On/Off check switch. 6 tubes including two voltage regulators plus 5Y3GT rectifier. For use on 105-125 volts, 50-60 cycles AC. Size: 12 $\frac{3}{4}$ x7x7 $\frac{1}{4}$ ". Shpg. wt. 25 lbs. Complete with tubes, but less crystals.

C21074 —
Your Cost..... **\$110.00**

HALLICRAFTERS HT-17 10 Watt CW Transmitter

Completely new. A high quality, low price transmitter or exciter for a high power final amplifier. Companion piece to the S-38 receiver for a low-cost ham shack. CW only, but has connections for addition of external modulator. Stylized and finished in the latest Hallcrafters motif. 80, 40, 20, and 10 meter bands.

Ready to plug into 105-125 volt, 50-60 cycle power source. Pi output net matches any antenna. Top hinged for easy changing of coils and crystal. 3-tube circuit with 807 final. Pilot lamp tuning indicator can be replaced by the SM-17 plate ma meter if desired, at extra cost. Complete with tubes but less coil sets and crystals. Dimensions: 12 $\frac{3}{4}$ x7 $\frac{1}{4}$ x8 $\frac{3}{8}$ ". Shpg. wt. 25 lbs.

C21076 —
Your Cost..... **\$69.50**

C21077—SM-17 Meter. Your Cost..... **\$6.50**
Coil Sets for Above

C10296—80 meters.....	\$3.50	C10298—20 meters.....	\$7.00
C10297—40 meters.....	3.50	C10299 10 meters.....	7.00

HALLICRAFTER HT-9 100 Watt Phone CW Transmitter

A medium powered transmitter designed for maximum flexibility and convenience. Completely self-contained. Requires only a mike or key, antenna, and 105-125 volts, 50-60 cy power to go on the air. Coil set consists of Osc., Buffer, and Final. Crystal plugs into top of Osc. coil. Five Osc. and Buffer coils and crystals may be plugged into the exciter section at one time and selected by the front-panel hand switch. Only remaining band-switching procedure is to replace the Final coil and readjust the final tank tuning capacitor. Coil sets available from stock for the 80, 40, 20, and 10 meter bands. Others on special order. Three ma meters to read cathode current of exciter or modulator, power amplifier grid current, and power amplifier plate current. Frequency response flat within 3 db from 100 to 5000 cycles. Input for any medium-level high-imp. mike. 100 W on CW, 75W on Phone. 100% mod. with low distortion. Built-in harmonic suppressor. Antenna coil matches 10-600 ohms resistive. 14 tubes with 814 as final. Built on heavy cadmium-plated steel chassis. Steel cabinet finished in gray enamel. Has heavy rubber mounting feet, ventilating openings top and sides and hinged top with interlock switch under the lid. Dimensions: 29 $\frac{1}{2}$ x12 $\frac{1}{2}$ x20 $\frac{1}{2}$ ". Shpg. wt. 125 lbs. Complete with tubes but less crystals and coil sets.

C21346 —
Your Cost..... **\$350.00**

Coil Sets for Above

C10287—80 meters... ..	\$10.85	C10286— 20 meters... ..	\$15.50
C10285—40 meters... ..	11.75	C10288—10 meters... ..	16.50

hallicrafters

Transmitting Equipment



KIT 1 (left) I send you Soldering Equipment and Radio Parts; show you how to do Radio Soldering; how to mount and connect Radio parts; give you practical experience.

KIT 2 (left) Early in my course I show you how to build this N.R.I. Tester with parts I send. It soon helps you fix neighborhood Radios and earn EXTRA money in spare time

VETERANS

You can get this training in your own home under G.I. Bill. Mail coupon for full details.

Be a RADIO Technician

Learn by PRACTICING in Spare Time

with **BIG KITS** of **RADIO PARTS** I send you

KIT 3 You get parts to build Radio Circuits; then test them; see how they work; learn how to design special circuits; how to locate and repair circuit defects.

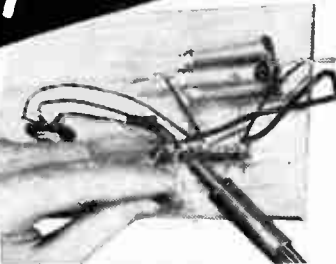

KIT 4 You get parts to build this Vacuum Tube Power Pack; make changes which give you experience with packs of many kinds; learn to correct power pack troubles.

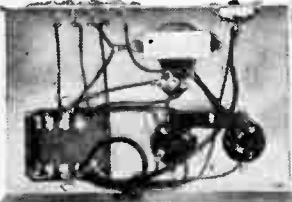

KIT 5 Building this A. M. Signal Generator gives you more valuable experience. It provides amplitude-modulated signals for many tests and experiments.



KIT 6 You build this Superheterodyne Receiver which brings in local and distant stations—and gives you more experience to help you win success in Radio.



My Course Includes Training in **TELEVISION • ELECTRONICS**
FREQUENCY MODULATION

Do you want a good-pay job in the fast growing Radio Industry—or your own Radio Shop? Mail the Coupon for a Sample Lesson and my 64-page book, "How to Be a Success in RADIO—Television, Electronics," both FREE. See how I will train you at home—how you get practical Radio experience building, testing Radio circuits with **BIG KITS OF PARTS** I send!

Many Beginners Soon Make EXTRA Money in Spare Time While Learning

The day you enroll I start sending EXTRA MONEY manuals that show you how to make EXTRA money fixing neighbors' Radios in spare time while still learning! It's probably easier to get started now than ever before, because the Radio Repair Business is booming. Trained Radio Technicians also find profitable opportunities in Police, Aviation, Marine Radio, Broadcasting, Radio Manufacturing, Public Address work. Think of even greater opportunities as Television, F.M.I. and Electronic devices become available to the public! Send for FREE books now!



J. E. SMITH, Pres. National Radio Institute

Find Out What NRI Can Do For You

Mail Coupon for Sample Lesson and my FREE 64-page book. Read the details about my Course; letters from men I trained; see how quickly, easily you can get started. No obligations! JUST MAIL. COUPON NOW in envelope or paste on penny postal. **J. E. SMITH, President, Dept. 7NL8, National Radio Institute, Pioneer Home Study Radio School, Washington 9, D. C.**

Sample Lesson **FREE**
64 Page Book

Mr. J. E. SMITH, President, Dept. 7NL8
National Radio Institute
Washington 9, D. C.

Mail me FREE, Sample Lesson and 64-page book. (No salesman will call. Please write plainly.)

Age.....

Name.....

Address.....

City..... State.....

(Please include Post Office Zone Number)

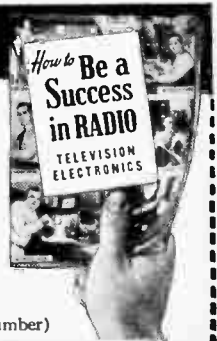

Approved for Training under GI Bill

HOW TO ORDER BY MAIL FROM CONCORD RADIO CORP.

CHICAGO 7, ILL. ←

MAIL YOUR
ORDERS TO

→ ATLANTA 3, GA.

901 W. JACKSON BLVD.
PHONE: HAYMARKET 0422 • TELETYPE NO. CG 320

265 PEACHTREE STREET
PHONE: WALNUT 5140-1 • TELETYPE NO. AT 398

READ THIS PAGE CAREFULLY FOR FASTEST POSSIBLE SERVICE

HOW TO ORDER

Use our convenient order blank (additional blanks sent on request). Please write in ink, legibly, and not more than ONE item to a line. Make sure you write the exact stock number and that the price is the one quoted for the item you want. Specify how we shall make shipment by checking the preferred square "Parcel Post", "Express", etc. We shall follow your instructions, but will change them wherever we are sure that such a change is to your better interest. Please keep all correspondence or remarks relative to your order on a separate sheet of paper. Make sure you include sufficient postage; all overpayments promptly refunded (if overpayment is under 10c, we will credit your account). **NOTE:** In many instances, it is impossible to show shipping weights. In practically all cases, it is a simple matter to estimate the weight of each article. Please be sure to include sufficient postage. We will credit you with any overpayments.

DOMESTIC ORDERS

We buy for cash and sell for cash; this explains our low price policy. We do not carry credit accounts, and we pass on to our customers all savings affected by the elimination of costly bookkeeping. We will ship C.O.D. if desired, providing a deposit of at least 20% accompanies your order. C.O.D. parcels may be shipped ONLY to places in the 48 states of the U.S. and to U. S. territories. **On small orders, remittance in full saves you extra costs.**

FOREIGN ORDERS

On foreign orders we require payment in the United States by irrevocable and confirmed letter of credit against documents, or 50% deposit with order, balance sight draft against B/L. All quotations F.O.B. our warehouse, with slight additional charge for export packing. Orders up to \$25.00 payable in full in advance, including postage. All remittances payable in U. S. funds.

2% TRANSPORTATION ALLOWANCE

On mail orders of \$25.00 or more, we allow you to deduct 2% from the total as transportation allowance, with the following exceptions: All Concord and National Co. products; all items sold under Fair Trade regulations; all items marked "Shipped Postpaid".

RETURNS

If you find it necessary to return any merchandise for adjustments, please write in advance stating the following: reason for return—when and where purchased—number of sales slip (if purchased over the counter). **If your shipment is received damaged, obtain a report from the postmaster or express agent and mail it to us.** Use a separate sheet of paper for all adjustment matter; do not add remarks to a new order for parts. **Do not include money in the package you return.** When returning merchandise, pack carefully, insure, and write your name and address on all packages and letters.

FINAL PRICES

Prices shown in this catalog are net. All discounts have been deducted, including 2% discounts for cash. **Prices are subject to change without notice;** we give customers the benefit of all reductions taking place after the catalog is published.

POSTPAID ITEMS

Items marked "Shipped Postpaid" do not require postage. Postpaid items refer only to shipments made within the 48 states of the U. S. only (does not include U. S. possessions).

SENDING MONEY

The safest and best way to send money is by: American Express; Post Office or Telegraph Money Order; bank drafts; firm checks; stamps. Do not send cash. If absolutely necessary to remit cash, send by registered mail only.

PARCEL POST RATES FOR ALL ZONES

Parcels up to 8 ounces may be shipped anywhere in the United States for 6c. Parcel post shipments to any zone must not exceed 70 pounds. The limit of size on all parcel post packages is 100 inches in length and girth combined, at

widest point. Example: a package 35 in. long, 10 in. wide and 5 in. high measures 65 in. in length and girth combined (length 35 in., plus twice 10 in. width, plus twice 5 in. height, equals 65 in.).

Weight In Pounds	ZONES							
	Local	First & Second to 150 Mi.	Third 150 to 300 Mi.	Fourth 300 to 600 Mi.	Fifth 600 to 1000 Mi.	Sixth 1000 to 1400 Mi.	Seventh 1400 to 1800 Mi.	Eighth Over 1800 Mi.
1	\$0 08	\$0 09	\$0 10	\$0 11	\$0 12	\$0 13	\$0 15	\$0 16
2	.09	.11	.12	.15	.18	.20	.24	.27
3	.09	.12	.14	.18	.23	.27	.33	.38
4	.10	.13	.16	.22	.28	.34	.42	.49
5	.10	.14	.18	.25	.34	.41	.52	.61
6	.11	.15	.20	.29	.39	.48	.61	.72
7	.11	.16	.22	.32	.44	.56	.70	.83
8	.12	.17	.24	.36	.50	.63	.79	.95
9	.12	.18	.26	.39	.56	.70	.89	1.06
10	.13	.19	.28	.43	.61	.77	.98	1.17
11	.13	.20	.30	.46	.66	.84	1 07	1 29
12	.14	.22	.32	.50	.72	.92	1.16	1.40
13	.14	.23	.34	.54	.77	.99	1.26	1.51
14	.15	.24	.36	.58	.82	1 06	1 35	1 63
15	.15	.25	.38	.61	.89	1 13	1 44	1 74
16	.16	.26	.40	.65	.94	1 21	1 53	1 85
17	.16	.27	.42	.68	.99	1 28	1 63	1 97
18	.17	.28	.44	.72	1 05	1 35	1 72	2 08
19	.17	.29	.46	.75	1 10	1 42	1 81	2 19
20	.18	.30	.48	.79	1 15	1 49	1 91	2 31
For Each Added lb. Add	1c	1c	2c	3½c	5½c	7c	9½c	11c

EXPRESS CHARGES

Express Charges are determined by the weight of the shipment and distance of Destination Office from Originating Office. The following chart will enable you to estimate charges.

Maximum Distance in Miles	50 Mi.	150 Mi.	300 Mi.	500 Mi.	750 Mi.	1000 Mi.	1500 Mi.	2000 Mi.
Cost up to 5 lbs.	\$0.25	\$0.25	\$0.30	\$0.35	\$0.45	\$0.55	\$0.65	\$0.65
" " 10 "	.30	.30	.40	.50	.65	.85	1.10	1.15
" " 15 "	.30	.34	.47	.59	.76	.98	1.33	1.67
" " 20 "	.36	.42	.59	.75	.97	1 11	1 71	2 19
" " 25 "	.42	.50	.71	.92	1 19	1 40	2 15	2 72
" " 35 "	.55	.66	.95	1 24	1 63	1 91	2 97	3 76
" " 45 "	.68	.82	1 19	1 57	2 06	2 43	3 79	4 81
" " 55 "	.80	.98	1 44	1 89	2 50	2 95	4 61	5 85
" " 70 "	.99	1 22	1 80	2 38	3 15	3 72	5 84	7 42
" " 85 "	1.18	1 46	2 16	2 87	3 80	4 50	7 07	8 99
" " 100 "	1 27	1 60	2 42	3 25	4 35	5 17	8 20	10 45

INSURANCE

Parcel Post and Express insurance rates are based on declared value. **ALL PARCELS WE SHIP MUST BE INSURED.**

Valuation	Parcel Post	Cost
Up to \$ 5.00	\$0.03
\$ 5.01— 25.0010
25.01— 50.0015
50.01— 200.0025

Express

Up to \$ 50.00..... No Charge
\$50.00— 150.00..... .10
For each additional \$100.00 value or portion thereof, charge is \$0.10.

EXPRESS & FREIGHT

Express and freight shipments are sent transportation charges collect. If your station has no agent, please send sufficient money to cover transportation. Charges are the same either way. All over-payments are promptly refunded.

C.O.D. SHIPMENTS

Transportation charges on C.O.D. parcels are slightly higher than those sent prepaid. C.O.D. charges in addition to the regular postage cost are as follows (including insurance):

Valuation	Extra Charge
Up to \$ 5.00 \$0.20
\$ 5.01— 25.0030
25.01— 50.0040
50.01— 100.0050
100.01— 150.0055
150.01— 200.0060

Post Office also charges an extra small money order fee on each C.O.D. parcel. **Save these fees by remitting in full.**

NOTE: Equipment built or ordered especially to meet customers requirements not subject to exchange, credit or refund. All orders for special merchandise must be accompanied by a deposit.

INDEX

Article	Page
A Adapters	65, 114, 115
AERIALS	
Auto	63, 130
Beam	133
F.M.-Dipole	132
Insulators	131
Loop	131
Transmitting	133
Wire	65, 128, 129
Aerial Accessories	131, 133

AEROVOX	84
Alarm System	111
Albums, Record	45
Aligning Tools	77
Alligator Clips	113

Amateur Receivers	152-155, 160, inside back cover
Ammeters	78, 79

AMPERITE	
.	34, 36, 65
Amphenol	77, 100, 102, 142
Amplifier Accessories	27-31
Amplifier Kits	108-111
Amplifiers	19-31
Mobile	24
Phono	41
Portable	21
Amplifier, Pre	44, 55

AMPLIFIERS PUBLIC ADDRESS	
.	18-31
Analizers	68-72, 76
Antenna Coils	136
Arbors	125
Attenuators	91

ASTATIC	37
Audio Oscillators	75
Audio Trans-formers	94-97, 99
Automatic Record Changers	17, 42, 43
Automatic Voltage Regulators	116

B Baffles	40
.	40
.	40
Ballasts	65
Conversion	147
Fluorescent	147-148
Batteries	66-67
Battery Charger	67
Battery Eliminator	67
Battery Tester	68

BELDEN	128-132
Belts, Drive	105
Bias Cells	103
Binding Posts	114
Blades, Hack Saw	126
Blanks, Record	46
Blow Torches	125
Blue Prints	108
Bolts	50

BOOKS



91, 117-121, 130

Booster Amplifiers	31
Brackets, Angle	50-51, 113
Brackets, Jewel	48
Brackets	
Mounting	90, 102, 144
Brackets, Pilot Light	48

BUD	151
Bulbs, Fluorescent	147
Bulbs, Pilot	48
Bulbs, Resistance	65
Bulbs, Tungar	67
Bumper Feet	113

BURGESS	66
Burglar Alarm	111
Bus Bar	127

Article	Page
Bushings	104, 142
By-Pass Condensers	80-84
C Cabinet Cement	41
.	144, 145
Cabinets, Radio Set	6
Cabinets, Record	
Player	43, 49
Cabinets, Repair Kits	41
Cabinets, Resistor	86-88
Cabinets, Speaker	37, 45
Cabinets, Television	109

Cable	
Cable, Coaxial	128, 129
Cable Connectors	101
Cables, Dial	105
Cables, Drive	105
Cable, Interphone	33, 128
Cables, Microphone	128, 129
Cables, Phono	128
Cable, Plugs	101
Cable, Speaker	128
Cable, Shielded	128, 129
Cable, Transmission	129
Caliper Rule	121
Call Systems	33
Carbon Granules	35
Cartridges, Phono	44, 46
Replacement Pack	46

CARRON	41
Cases, Carrying	40
.	78, 145
Record	45, 49
Cathode Ray Oscillographs	74
Cement, Cone	41
Cement Kit	41
Cement, Radio	112

CENTRALAB	
.	89, 91, 93
Chanalyst	69
Charger, Battery	57, 67
Chassis Cradle	123
Chassis, Metal	61, 145
Chassis, Radio	144, 145
Chassis, Punch	145
Chokes, Filter 57, 95-99, 137	
Chokes, R.F.	61, 136, 137
Chokes, Suppressor	98
Chisel Cutters	126
Chucks	125
Clamps, Cable	113
Clamps, Tube	113

CLAROSTAT	93
Clips	
Alligator	113-114
Battery	113
Fahnestock	113
Fuse	50, 105
Plate Caps	151
Screen Grid	113, 151
Cleaning Fluid	112
Cloth, Grille	41
Clocks—Electric	147
Code Practice Sets	141

Coils	
Antenna	54, 136
B.F.O.	136
Dope	112
Discriminator	136
F.M.	63
Forms	151
I.F.	53, 54, 136
Oscillator	136
Phono Oscillator	136
Plug-in	151
R.F.	54, 136
Speaker Field	40
Coil Winder	126
Coloring, Dial Light	48
Communicating Systems	33
Communication Receivers	152-155, 160, inside back cover

CONCORD	
Aerial Kits	131
Amplifiers	108-109
Baffles	40
Crystal Detector Kit	108
Mike Accessories	37

Article	Page
Power Supply Kit	108-109
Portables	14-15
Public Address Systems	18-31
Radio Sets	1, 4, 5, 9-16
inside front cover	
outside back cover	
Console 4-7, 9, 12, outside back cover	
Receiver Kits	106-109
Record Players	17, 43, 47, 49
Speakers	37-40, 53
Table Model Radios	1, 9-11, 13-16
Training Kits	108, 109
Transmitter Kit	150
Tubes	32

Condensers	
Auto	83, 130
By-Pass	52, 80, 84
Cartridge	80-81
Ceramic	63
Electrolytic	52, 80-81
Filters	52, 80-85
Kits	80
Mica	53, 81, 83, 85
Midnet	101
Neutralizing	62, 132
Oil Filled	52, 82
Photo Flash	63, 80
Plastic Glassmike	63
Padder	61, 62, 139
Pyranol	52
Transmitting	85
Trimmer	53, 62
Variable	62, 104, 139
Vibrator	81

Cones, Speaker	41
Connectors	101, 115
Connectors, Antenna	130
Connectors, Micro- phone	101, 115
Controls, Volume	54, 90-93
Converter, Freq.	151
Converters, Rotary	110
Cords, Battery	60
Cord Connectors	101
Cord, Dial	105
Cords, Extension	129
Cord, Line Resistor	65
Cord, Microphone	61

CORNELL-DUBILIER 76, 81, 83	
Couplings, Flexible	138
Couplings, Shaft	104, 138
Covers, Microphone	35
Cradle, Chassis	123
Crystal Detector	106
Crystal Pickup	44
Crystal Sets	106, 108
Crystal Socket	135
Crystal, Transmitting	135
Cushions, Phone	140

CUTLER HAMMER	102
Cutters, Circle	126
D Detector, Crystal	106
Dials	
Accessories	104, 105
Cable	105
Drives	50, 62, 104
Drive Springs	50
Lights	48
Plates	104, 138
Discs, Recording	46
Drill Gauge	121
Drills	122, 123, 125, 126
Drives	138
Drive Bands	105
Dry Cells	66, 67
Drum Unit, Speaker	39
Dynamotors	110

DUMONT	74-75
E Earphone Cushions 140	
.	140
Electrical Appliances	148
Electric Eye Units	110

Article	Page
Electrodes	110
Electroplater	126
EIMAC	143
Electric Clocks	143

ELECTRO-VOICE	
.	34, 36, 37
Eliminators, Battery	67
Eliminators, Noise	83, 130
Enclosures, Speaker	38
Escutcheon	100
Exciter, Transmitter	150
Extension Cords	129
Extension Shafts	90

F Fader Controls	54, 91
.	76
Ferret Instruments	75-76
Felts, Voice Coil	41
Field Coils, Speaker	41
Filament Trans-formers	97-99
Film Resistors	88
Filter Chokes	95, 99
Filter Condensers	80-85
Filter, Equalizer	44
Filters, Interference	63, 83
Filters, Noise	61, 83, 147
Fixtures, Electric	146
Flashlight Batteries	66-67
Flashlight Bulbs	48
Flocking Kit	112
Fluorescent— Accessories	147-148

FLOUORESCENT LIGHTS	
.	146-147
Fluorescent Noise Suppressor	147
Flux, Solder	125
Forms, Coil	151
Freq. Calibrator	55, 135

FREQUENCY MODULATION	
.	1, 4-8, 149, 154, inside back cover
.	132
.	104
.	105
.	61, 105
.	78, 105
G Gas-Electric Plants 110	
.	121
.	121

GARRARD	42
Gauntlet	110
Generators	110
Generators, Signal	73, 75

GENERAL ELECTRIC	
.	32, 71, 74-76
Granules, Carbon	35
Grille Cloth	41
Grinder	123
Grommets	50-51
Ground Rods	63

GUARDIAN	134
HALLI-CRAFTERS	
.	151-155-inside back cover

HAMMARLUND	153
Hardware	50, 52, 113
Headphones	60, 140
Hearing Aid Batteries	146
Heintz-Kaufman	63

HICKOK	
.	69-70, 72-74
Home Recording	18, 43, 47
Horns	39
HOW TO ORDER	
.	157
How to Select Sound Systems	20
HYTRON	143

Article	Page
I Inverters	57, 115
.	142
Insulating Material	131, 142

INTER-COMMUNICATION

Interference Eliminators	33, 49
I.R.C. Rheostats	89
Irons, Soldering	124, 125
I.R.C. Resistors	86
I.R.C. Controls	92-93
Jacks	61, 114-115
Jackson Testers	

INDEX

Article Page

MEISSNER
18, 69, 73, 119, 150
Meters.....58, 78, 79
Merit Trans.....97
Microphones
34-36, 106-107
Accessories
34, 35, 37, 94, 101, 115
Millen Sockets.....100
Motor.....60
Motors, Phonograph 43, 47
Motor Control.....54
Mounting Strips.....101
Multiampl.....25-31

ADD-A-UNIT ACCESSORIES

Name Plates.....138

NATIONAL

138, 139, 152, 160
Needles.....45
Neon Glow Lamps.....48, 105
Neon Testers.....77
Neutralizing Tools.....77
Noise Eliminators.....83-130
Nuts.....50-51, 90

OHMITE

87-89
Ohmmeters.....70-72
Oscillators, Code
Practice.....141
Oscillators, Phono.....43
Oscillators,
Test.....49, 73, 75, 135
Oscilloscopes.....71, 71, 75
Output Meters.....70-72
Output Trans.....38, 94, 99

Pads, "T" and "L"

51, 91
Panels.....114
Panel Light Assembly.....61
Paste, Soldering.....125
Permeability Tuners
and Dials.....62, 104
Phone Cords.....140
Phone Plugs.....114, 115, 110
Phone Tips.....114
Phones, Ear.....140

Phonograph

16-18, 43, 106
Accessories.....43-46
Amplifiers.....19, 43, 108, 109
Albums.....45
Cartridges.....41, 46
Changer.....17, 42
Motors.....43
Needles.....45
Oscillators.....43
Pick up.....43, 41, 63
Radio Combination 6, 7,
9, 12, 16, inside front cover,
outside back cover
Recording Discs.....46
Tone Equalizers.....44

Photo-Electric Equipment

111
Photo Flash Trans.....63, 96
Pilot Light.....48
Plates, Chassis.....115
Pliers.....122
Plug-in Coils.....137
Plugs, A.C......65, 101, 148
Banana.....111
Battery.....66
Cable.....101
Foreign Adapter.....65
Hole.....113
Jones.....101
Microphone.....101
Phone.....115
Phonograph.....114
Tip.....114

POPULAR MECHANICS KITS

108
Portable Amplifiers.....21-23, 26-30

Article Page

Posts, Binding.....114
Potentiometers.....90-93, 133-54
Power Controls.....89, 116
Power Cord.....65, 148
Power Packs.....66-67, 116
Power Stages.....31
Power Supply Kits.....108-109
Power Trans-
formers.....56, 59, 94-99
Prods, Test.....70-71, 77
Projectors, Speaker.....39
Punch, Metal.....145



QUAM

40
Racks.....51, 144
Radar Units.....55

RCA

Batteries.....67
Test Instruments.....69-70, 74-75
Tubes.....32, 143
Radio Chemicals.....112
Radio Sets
Portables.....14-16
Table Model
9-11, 13, 15, 16, 149
Radio Receivers, Short
Wave 4, 5, 13, 152-155,
160, inside back cover
Radiophones.....93
Receiver Kits.....106, 108
Receptacles.....48-101
Record Accessories.....43-17
Record Albums.....45
Record Blanks.....46
Record Cabinets.....49
Record Changers Auto-
matic.....17, 42-49
Record Changer Bases.....42
Record Holder.....45
Record Players 17, 13, 108
Record Player Switch.....43
Record Renewer.....46
Recorders.....18, 43, 47
Recording Cutter.....47
Recording Head,
Magnetic.....43
Recording, Meter.....47
Rectifiers, Copper Oxide 79
Selenium.....63
Regulators, Voltage 65, 116
Relays.....111, 131
Antennas.....130, 131
Ballast.....65
Chokes, R.F.....137
Coil Forms.....151
Condensers.....83
Headphones.....110
Meter Case.....78
Resistors.....88
Suppressors, Auto
Radio.....130
Transformer.....97
Volume Controls.....93

Resistors

Adjustable.....86-89
Cabinet.....86-88
Carbon.....54, 86
Center Tap.....88
Guide.....86
Kits.....53-54, 86, 87, 89
Line Cord.....65
Meter Shunt and
Multipliers.....78, 79
Sliders.....86-88
Variable.....51, 86-89
Vitrous.....87-88
Voltage Di-
vider.....53, 86-89
Wire Wound 86-87-88-89
Resistor Tubes.....65
Rheostats.....89, 91

Article Page

Rider Books.....120
Ribbon Microphones.....36

RME

151, 152
Rods.....111, 113
Rules.....121

SANGAMO

85
Saw.....126
Scratch Remover.....112
Screen Grid Caps.....151
Screw Drivers.....77-122
Screws.....51, 56, 113
Service Manuals (See
Books)
Shafting, Fibre and
Brass.....104
Shafts, Volume
Control.....90-92
Shields, Tube.....61, 113
Shims, Cone Centering.....41

SHIPPING INFORMATION

157
Short Wave Receivers 1,
5, 13, 152-155, 160, inside
back cover
Shunts.....79

SHURE

34, 36
Shurite Meters.....79
Signal Tracers.....76
Signal Generators (See
Test Equipment)

SIMPSON

68, 71, 73
Sockets.....61, 100, 101
Sockets, Crystal.....135
Sockets, Jones.....101
Sockets, Fluorescent
Starters.....148
Solder.....76, 84
Solder.....125
Soldering Irons.....124-125
Soldering Pots.....125

Sound Systems

19-31
Mobile.....21-30
Portable.....30
Speakers.....50-51
Spaghetti Tubing.....127

Speakers

37-40
Accessories.....38, 41, 101
Bass-Reflex.....37-38
Baffles.....40
Cabinets.....37
Cable.....128, 129
Case.....31, 40
Cement.....41
Connectors.....101
Cones.....41
Coaxial.....37-38
Dynamic.....38, 40, 53
Field Coils.....41, 53
Industrial paging.....39
Oval.....40
Permanent Magnet
37, 38, 10, 53
Projector.....39
Radial.....39
Repair Service.....41
Transformers.....38, 10, 91, 97, 99
Speaker Units.....37

SPEED-X

126
SPRAGUE 76, 80, 89
Sprayers.....112, 125
SPINTITES.....122
Springs, Dial.....105
Springs, Microphone.....35

STANCOR

95, 98
Power Pack.....67
Stands, Soldering Iron.....125
Staples.....123
Stapling Machine.....123
Stroboscope.....43
Strips.....101

Article Page

Suppressors, Ignition.....130
Suppressors, Parasitic.....130

SUPREME

68, 70, 75
Switches
Anti-Capacity.....103
Attachment.....90, 93
Control Switches.....90, 93
Canopy.....103
Gang.....54
Kits.....103
Knife.....103
Microphone.....115
Mike Stand.....35
Momentary.....103
Mu.....103
Push-Button.....54, 103
Rotary.....103
Slide.....103
Selector.....54
Time.....111
Toggle.....103
Tone.....93
Switch Plates.....103

Tacks

50
Talk-A-Phone.....33
Tape, Friction.....105
Tape, Scotch.....105
Tape Sender.....111
Taps and Dies.....126

TAYLOR

143
Telegraph Sets.....107
Television Antennas.....132
Television Kit.....109
Terminal Strips.....53, 101

TEST Instruments

68, 76, 78, 79,
135
Test Prods and
Accessories.....70, 71, 77, 79
Test Prod Wire.....128

THORDARSON

98
Tips, Iron.....124, 125
Tip Jacks.....114
Tone Controls.....93
Tools.....61, 122, 123, 126
Tools, Aligning.....77
Torches, Arc.....110
Torches, Blow.....125
Turntables.....47
Training Kits.....106-109

Transformers

Audio.....94-96, 99
Driver.....57, 94, 98-99
Filament.....56, 97-99
High Current.....57
Input 57, 91, 95, 97, 99
IF.....53
Interstage.....57, 91-93
Microphone.....91
Modulation.....98-99
Output 38, 57, 91, 97, 99
Photo Flash.....96
Power.....56, 91, 97, 99
Plate.....56, 98-99
Speaker 38, 40, 91, 97, 99
Step down.....97
Transmitting.....135
Vibrator.....57
Voltage Regulator.....116

TRANSVISION

109
Transmission
Cable.....128-129
Transmit-
ter 150, 152, 153, 155
Transmitter Keys.....111
Transmitter Kit.....150
Transmitter Tuning
Unit.....55

TRIMM

110
Trimmers.....62

TRINDL

110

Article Page

TRIPLETT
68, 73, 78
Trumpets.....39
True-Sonic Speakers.....37



Ballast.....65
Caps.....113
Cathode-Ray.....143
Photocells.....143
Transmitting.....143
Voltage Regulator.....65
Tube Shields.....61, 113
Tube Sockets.....100
Tube Testers.....68-69
Tubing, Insulated.....142
Tubing, Plastic.....127
Tuning Indicator.....100
Tuners-FM-AM.....149
Tuning Wand.....77
Tungar Bulbs.....67
Tungar Chargers.....67

TURNER

34-35
University Speakers.....39

U.T.C.

96, 99

Varitap

Choke.....96
Variable Condensers 62, 139
Variometer.....62
Vibra Packs.....116
Vibrator Trans.....57
Vibrator Condensers.....81
Vibrators, Auto
Radio.....63, 130
Vibro Tool.....121
Voltage Dividers.....86-89
Voltage Regulators.....116
Volt Ohmmeters 70, 72, 75
Volume Controls 90, 93
Volume Control
Accessories.....90-92
Volume Control Guide.....92
Volume Level Indicator.....78

Wafer Switches

100
Wall Baffles 37, 38, 40
Washers.....50, 52, 113

Ward Antenna

132

WARD-LEONARD

134
Wave Meter.....135

WEBSTER

18, 12, 43, 44
Welding Rods.....110
Welding Equipment.....110

WESTON

68, 70, 71
Winder, Coil.....126

Wire

Aerial.....128, 129
Bell.....127
Bus.....127, 128
Cable.....127
Cotton Covered.....127
Coil Wire.....127
Fixture
Hook Up 127, 128, 129
Lead-in 102, 128, 129, 132
Magnet.....127
Push-Back.....127, 128
Resistance.....127
Rubber Covered 127, 128
Shielded.....128, 129
Telephone.....129
Wire Stripper 63, 125, 126
Wrenches.....50, 90, 122

NATIONAL *Receivers*

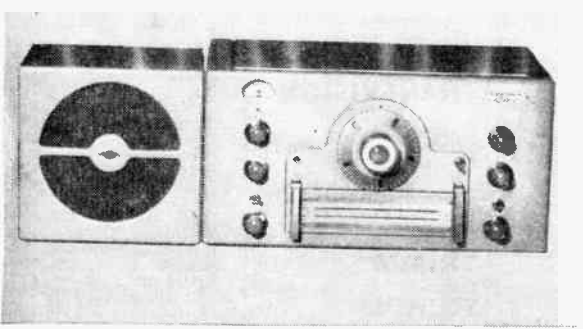
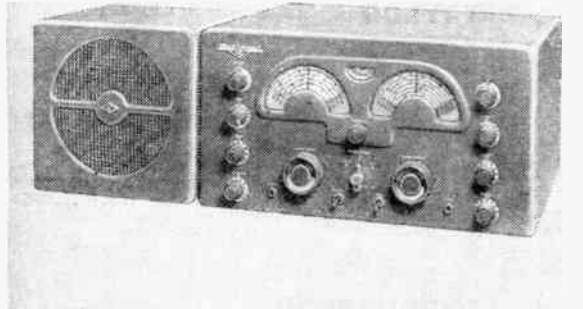

NATIONAL NC-46

General coverage receiver. Professional appearance. All the latest features for smooth easy control. The long clear-vision dial has the new sloping front. Band spread dial for accurate logging. 540 kc continuous through 30 mc in 4 bands. The band-spread dial provides 70 dial divisions in the 80-meter band, 50 in the 40-meter band, 56 in the 20-meter band, and 40 in the 10-meter band.

Features include a noise limiter with automatic threshold control, CW oscillator, separate RF and AF gain controls, and amplified and delayed AVC. The push-pull audio output stage delivers approximately 4 watts. Both the straight-line-frequency tuning capacitor and the separate band-spread capacitor use an inertia-type drive. Provision is made for either headphone or speaker.

Circuit consists of a 6K8 converter, two 6SG7 IF stages, 6H6 detector/limiter, 6SF7 AVC amplifier, 6SJ7 BFO, 6SC7 phase inverter, two 25L6GT output, and 25Z5 rectifier. Sensitivity approximately 5 microvolts for 50 milliwatt output over entire range. Output with AVC varies less than ± 4 db with inputs ranging from 10 to 100,000 microvolts. Dimensions: $9\frac{7}{8} \times 17\frac{3}{4} \times 12\frac{3}{4}$ ". Shpg. wt. 50 lbs. 105-130 volts AC or DC.

C21259—Model NC-46, Complete with tubes. Less **\$97.50**
Your Cost.....**\$9.90**

C21258—Matching Speaker in Cabinet.

NATIONAL NC-173

For both Amateur and Commercial use. 11-tube superhet plus rectifier and plus VR for both CW and Phone stability. 1 TRF, separate stabilized IIF osc., 1st det., 2 IF's, diode 2nd det., AF limiter, AVC amplifier, stabilized BFO, 2 AF stages. 540 kc-31 mc plus 48-56 mc. Separate bandspread tuning knob and dial for the 80, 40, 20, 10, and 5-meter amateur bands.

Separate AVC amplifier permits using AVC on both phone and CW. New highly effective wide range crystal IF filter with adjustable band width. A new "double action" noise limiter circuit is equally efficient on either CW or phone, has panel mounted threshold control. The "S" meter, connect-d in the AVC circuit, is calibrated 1-9 "S" units and does not require adjustment. Can be used on both phone and CW signals. Conventional audio tone control. Headphone and pick-up jacks are located on front panel. 3.5 watts audio output at 8 or 500 ohms for speaker operation. Receiver housed in attractive modern metal cabinet finished in smooth gray. The speaker in a matching table model cabinet, is the PM field type with 8 ohm impedance. Complete with tubes and instructions. Shpg. wt. 70 lbs.

C21254—Table Model Receiver.
C21256—Rack Mounting Receiver. **\$179.50**
Your Cost, either.....

C21255—Table Model Speaker.
C21257—Rack Mounting Speaker. **\$10.00**
Your Cost, either.....

NATIONAL NC-2-40D

One of the finest communications receivers ever made. 490 kc-30 mc continuous. Knob on the front panel moves 6 calibrated coil ranges into position below the tuning capacitor and plugs them into the circuit, thus assuring very short leads. Tuning control has 60:1 ratio, but dial can be spun rapidly for fast tuning.

Superhet circuit uses 11 tubes plus rectifier. 1 RF, separate IIF osc. of new design for extreme stability, 1st det., 2 IF's, 2nd det./limiter, AVC, BFO, AF amp./phase inverter, push-pull 6V6's which deliver 8 watts, and rectifier. The IIF osc. design eliminates detuning effects of RF gain control and motorboating or fluttering on strong signals. RF and IF circuits use polystyrene coil forms. Padding and trimming capacitors are air dielectric. Signal: image better than 30 db at ten meters. Line shift from 100 to 120 volts produces less than 1 kc detuning at 30 mc. Crystal filter has exceptionally wide selectivity range for use on both Phone and CW.

Operates on either 110/120 volt or 220/240 volt, 50/60 cycle source. Switch in primary of plate transformer permits use of either voltage. Shipping weight 95 lbs.

C21261—Model NC-2-40D, Complete with tubes. **\$225.00**
 Less Speaker.....
C21262—10 inch speaker mounted in separate cabinet specially designed to harmonize with the receiver's trim lines..... **\$16.44**

NATIONAL HRO-7

Ultra-modern version of the famous HRO Communications Receivers. 11 tubes plus the new miniature type OA2 voltage regulator for extreme oscillator stability. New miniature type 6CA high-frequency oscillator. Two RF amplifiers, two IF amplifiers. Wide-range adjustable selectivity with 6 position switch for crystal filter operation. Maximum band-spread on the amateur bands. New automatic double-action adjustable threshold noise limiter. High signal-to-noise ratio, high image rejection, high sensitivity. These are just a few of the features of this latest addition to the HRO line.

Although normally supplied with plug-in coil sets for 1.7-30mc, will cover radio range, communications, marine, and broadcast-band frequencies by the addition of coil sets for 50-430 kc and 480-1700 kc. An accessory Connector socket is provided for heater voltage, B \pm IF output, AVC voltage, and AF input, to accommodate a wide variety of accessories such as a NB FM discriminator, crystal calibrator, etc. Front panel contains tone control. AF output stage uses 6V6GT/G. Dimensions: $19\frac{3}{4} \times 10\frac{1}{2} \times 12\frac{3}{4}$ ". Shpg. wt. 55 lbs.

C21253—HRO7T, Table model, complete with tubes and four sets of coils covering 1.7-30mc, less speaker and power supply. **Your Cost**.....**\$279.00**
C21252—MCR Speaker to match HRO-7T. **\$12.00**
Your Cost.....
C21265—Power Supply No. 697. **20.36**
Your Cost.....

Note: Rack-mounting model of HRO-7 available on special order.



HALLICRAFTERS Model SX-43

Designed to give the discriminating amateur the performance of his dreams at full frequency coverage . . . to give his family superb AM and FM reception . . . in Hallicrafters richest and most professional looking cabinet and panel . . . and all at a medium price.

Frequency coverage is 540 KC to 44 MC, AM or CW, 44 to 55 MC, AM, wide-band FM or narrow-band FM and 88 to 108 MC on AM or wide-band FM. Electrical bandspread with separate dial for the 80, 40, 20 and 10 meter bands. Complete and convenient panel controls provide for Xtal filter with phasing control, 4 degrees of selectivity, BFO pitch control, phono jack and switch, "S" meter, Noise limiter, tone control and Receive/Standby switch.

TUBES: 1—6BA6 RF amplifier; 1—7F8 converter-oscillator; 1—6SG7 1st IF amplifier; 1—6SH7 2nd IF amplifier and second converter, band 5 AM; 1—6SH7 3rd IF amplifier (10.7 Mc.); 1—6H6 AM detector and noise limiter; 1—6AL5 FM detector; 1—6SQ7 1st AF amplifier; 1—6J5 beat frequency oscillator or second converter oscillator, band 5; 1—6V6 audio output tube; 1—5Y3 rectifier.

Temperature compensated. 3 watts output flat from 70 to 8,000 cps. 300 ohms antenna input impedance. Speaker terminals for 5 000 and 500 ohms outputs to match R-44 Bass Reflex speaker. Dimensions: 18½" x 8¼" x 13". Shpg. wt. 45 lbs. For 105-125 volts, 50/60 cyc.

C21064—Your Cost \$169.50

Model SX-43 U. For 110, 130, 150, 220, 250 volts, 25/60 cyc. **C21065—Your Cost \$178.05**

Model R-44 Bass-Reflex Speaker. For use with SX-43. **C21066—Your Cost \$19.50**

HALLICRAFTERS Model S-40A

A completely new conception of receiver beauty and styling with circuit design features never before available in this price class. The steel cabinet is attractively finished in rich satin black with satin chrome trim and hinged "Airodized" top. Dials and controls color-coded in red for Broadcast-band reception by the entire family.

Frequency 540 KC—43 MC with inertia-flywheel tuning and separate electrical bandspread dial. RF section uses the same perm-tuned "Microset" coils and temperature compensation as in the most expensive models. The advanced superhet circuit furnishes 2½ watts of audio power to the internal PM speaker.

Nine Tubes: 1—6SG7 RF amplifier; 1—6SA7 converter; 1—6SK7 1st IF amplifier; 1—6SK7 2nd IF amplifier; 1—6SQ7 2nd detector and 1st audio amplifier; 1—6F6G output audio amplifier; 1—6H6 automatic noise limiter and gas gate; 1—6J5GT beat frequency oscillator; 1—80 rectifier.

Front panel jack for phones. Socket is provided for connection of the external Model SM-40 "S" meter. Panel controls provide for 3-position tone selection, CW with adjustable pitch, AVC or MVC. Automatic Noise Limiter, Standby/Receive and RF Sensitivity. Dimensions: 18½" x 9" x 11". Shpg. wt. 33 lbs. For 105-125 volts, 50-60 cyc.

C21094—Your Cost \$89.50

Model S-40 U Universal. 110, 130, 150, 220, 250 volts, 25 to 60 cyc. **C21085—Your Cost \$98.50**

SM-40 External S-meter. 5¼" x 4" x 4½". Shpg. wt. 3 lbs. **C21086—Your Cost \$16.00**





THE Concord "Masterpiece" FM-AM PHONO-RADIO WITH AUTOMATIC RECORD CHANGER

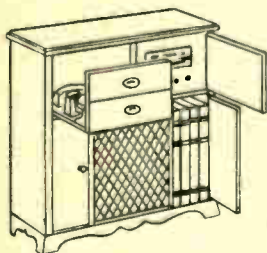

Everything you could possibly desire in a fine Radio-Phonograph Combination is yours in this magnificent instrument. Only Concord—with its unrivaled resources—could make so outstanding an AM-FM Automatic Phonograph-Radio Combination a reality. Here is true luxury at a moderate price.

THE DISTINGUISHED CABINET:

A luxurious mahogany console. Lustrous, hand-rubbed finish adds richness and beauty to any home. Distinctive Regency styling. Has convenient "slide away" drawer for automatic record changer with handsome burnished brass hardware. Cabinet has convenient storage space for records and albums.

AM-FM BROADCASTS: Receives new High Fidelity FM (Frequency Modulation) stations—88 to 108 megacycles—as well as Standard broadcasts—540 to 1700 kilocycles. Amazingly powerful 11 tube (including rectifier) super-heterodyne, with advanced circuit design, provides 15 tube performance. Remarkable sensitivity and selectivity. Has large "slide rule" dial, full range bass-treble tone control and improved automatic volume control.

ADVANCED FM RECEPTION: Newest FM Ratio Detector circuit assures ease of tuning, low noise level, freedom from AM interference and ample gain. An outdoor

aerial is unnecessary in most locations for perfect FM reception.

AUTOMATIC PHONOGRAPH: Precision automatic record changer plays ten 12" or twelve 10" records at one sitting. Has "Floating Point" needle. Rides gently on your records, yet reproduces with utmost fidelity.

HIGH FIDELITY REPRODUCTION: Powerful 13 watt push-pull amplifier, with large 10" PM speaker provides true High Fidelity reproduction of both recordings and radio broadcasts. Gives full benefit of FM quality.

NEWEST TUBES: Powerful, efficient circuit uses 1—6BA6 FM, RF Amplifier, 1—7Q7 AM Oscillator, Mixer, 1—7AH7 IF Amplifier, 1—7AG7 FM Detector driver, 1—7A6 FM Detector, 1—7F8 FM Oscillator, Mixer, 1—7C6 AM Detector, Audio amplifier, 1—7F7 Audio amplifier, Inverter, 2—7C5 Push-Pull amplifiers, 1—5Y3 Rectifier.

To the smallest detail—this great AM-FM Phono-Combination is an achievement. Now—you have the opportunity to own, and enjoy for years ahead, this unparalleled combination . . . at a price that makes it truly a miracle value.

Model 1-1101. Concord 11 tube (including rectifier) FM-AM Console Phono-Radio Combination with Automatic Record Changer with Built-in Loop Antenna for Standard Broadcasts and Folded Dipole antenna for FM Broadcasts. For operation on 105/125 volts AC; 50/60 cycles. Size: 34 $\frac{1}{4}$ " x 33 $\frac{1}{8}$ " x 16 $\frac{1}{2}$ ". Shpg. wt. 100 lbs.

Your Cost \$189.50

ALL CONCORD RADIOS ARE R. C. A. AND HAZELTINE LICENSED.

CONCORD RADIO CORP.

Chicago 7, Ill. Mail Order & City Sales
 901 WEST JACKSON BLVD.
 Phone: HAYmarket 0422

Chicago 6, Ill. City Sales Only
 229 WEST MADISON STREET
 Phone: CENTral 5971

Atlanta 3, Ga. Mail Order & City Sales
 265 PEACHTREE STREET
 Phone: WALNUT 5140-1

HOW TO ORDER

Use our convenient order blank (additional blanks sent on request). Please write or ink legibly, and not more than ONE item to a line. Make sure you write the exact stock number and that the price is the one quoted for the item you want. Specify how we shall make shipment by checking the preferred square "Parcel Post", "Express", etc. We shall follow your instructions, but will change them whenever we are sure that such a change is to your better interest. Please keep all correspondence or remarks relative to your order on a separate sheet of paper. Make sure you include sufficient postage; all overpayments promptly refunded (if overpayment is under 10c, we will credit your account). **NOTE:** In many instances, especially in the tabulated lists of merchandise, it is impossible to show shipping weights. In practically all cases it is a simple matter to estimate the weight of such article. Please be sure to include sufficient postage. We will credit you with any overpayments.

DOMESTIC ORDERS

We buy for cash and sell for cash. We explain our low price policy. We do not carry credit accounts, and we pass on to our customers all savings effected by the elimination of costly bookkeeping. We will ship C.O.D.'s if desired, providing a deposit of at least 25% accompanies your order. C.O.D. parcels may be shipped ONLY to places in the 48 states of the U.S. and to U.S. territories. On small orders, remittance in full saves you extra collection costs.

FOREIGN ORDERS

On all foreign orders we require payment in the United States by irrevocable and confirmed letter of credit against documents, or 50% deposit with order, balance sight draft against B/L. All quotations are F.O.B. our warehouse, with slight additional charge for export packing (shown up to \$25.00 payable in full, in advance, including postage). All remittances payable in U.S. funds.

2% TRANSPORTATION ALLOWANCE

On domestic mail orders of \$10.00 or more, we allow you to deduct 2% from the total as transportation allowance, with the following exceptions: All Catalog and National Co. mail sets; all items sold under Fair Trade regulations; all items marked "Shipped Postpaid."

RETURNING MERCHANDISE

If you find it necessary to return any merchandise for adjustments, please write in advance stating the following: reason for return—when and where purchased—number of sales slip (if purchased over the counter). If your shipment is received damaged, obtain a report from the postmaster or express agent and mail it to us. Use a separate sheet of paper for all adjustment matters or for add remarks to a new order for parts. Do not include money in the package you return. When returning merchandise, pack carefully, insure, and write your name and address on all packages and letters before returning to us.

FINAL PRICES

Prices shown in this catalog are net, and except where marked POSTPAID, do not include postage. All discounts have been deducted, including 2% discount for cash. Prices are subject to change without notice; we give customers the benefit of all reductions taking place after the catalog is published.

POSTPAID ITEMS.

Items marked "Shipped Postpaid" do not require postage. Please note that Postpaid terms refer only to shipments made within the 48 states of the U.S. only (does not include U.S. possessions).

SENDING MONEY

The safest and best way to send money is by American Express) Post Office or Telegraph Money Order; bank drafts; bus checks. Do not send cash. If absolutely necessary to send cash send by registered mail only. Do not hesitate to include sufficient postage overpayments, will be promptly refunded or credited whichever you prefer.

PARCEL POST RATES FOR ALL ZONES

Parcels up to 8 ounces may be shipped anywhere in the United States for 1c. Parcel post shipments to any other zone not exceed 25 pounds. The limit of size for all parcel post packages is 100 inches in length and girth

combined, at widest point. Example: a package 15 in. long, 50 in. wide and 5 in. high measures 10 in. in length and girth combined (length 15 in. plus twice 25 in. width, plus twice 5 in. height, equals 65 in.).

Weight in Pounds	ZONES							
	Local	First & Second (to 100 MI.)	Third (100 to 200 MI.)	Fourth (200 to 400 MI.)	Fifth (400 to 600 MI.)	Sixth (600 to 1000 MI.)	Seventh (1000 to 1500 MI.)	Eighth (Over 1500 MI.)
1	80 08	80 09	80 10	80 11	80 12	80 13	80 14	80 15
2	09	11	12	13	14	15	16	17
3	09	12	13	14	15	16	17	18
4	10	13	14	15	16	17	18	19
5	10	14	15	16	17	18	19	20
6	11	15	16	17	18	19	20	21
7	11	16	17	18	19	20	21	22
8	12	17	18	19	20	21	22	23
9	12	18	19	20	21	22	23	24
10	13	19	20	21	22	23	24	25
11	13	20	21	22	23	24	25	26
12	14	21	22	23	24	25	26	27
13	14	22	23	24	25	26	27	28
14	15	23	24	25	26	27	28	29
15	15	24	25	26	27	28	29	30
16	16	25	26	27	28	29	30	31
17	16	26	27	28	29	30	31	32
18	17	27	28	29	30	31	32	33
19	17	28	29	30	31	32	33	34
20	18	29	30	31	32	33	34	35
For Each Added lb. add	1c	1c	2c	2 1/2c	3c	4c	5c	6c

EXPRESS CHARGES

Express Charges are determined by the weight of the shipment and distance of Destination Office from Originating Office. The following chart will enable you to estimate charges. **NOTE:** Add 1% to amounts shown below to cover Federal Tax.

Maximum Distance in Miles	50 MI.	100 MI.	200 MI.	300 MI.	400 MI.	600 MI.	1000 MI.	1500 MI.
Cost up to \$ 5.00	\$1.85	\$1.95	\$2.10	\$2.25	\$2.40	\$2.65	\$3.00	\$3.35
10	20	25	30	35	40	45	50	55
15	22	27	32	37	42	47	52	57
20	24	29	34	39	44	49	54	59
25	26	31	36	41	46	51	56	61
30	28	33	38	43	48	53	58	63
35	30	35	40	45	50	55	60	65
40	32	37	42	47	52	57	62	67
45	34	39	44	49	54	59	64	69
50	36	41	46	51	56	61	66	71
55	38	43	48	53	58	63	68	73
60	40	45	50	55	60	65	70	75
65	42	47	52	57	62	67	72	77
70	44	49	54	59	64	69	74	79
75	46	51	56	61	66	71	76	81
80	48	53	58	63	68	73	78	83
100	52	57	62	67	72	77	82	87

PARCEL POST INSURANCE RATES

PARCEL POST INSURANCE rates are 1c for parcels up to \$50; 10c for parcels from \$50 to \$25.00; 15c for parcels from \$25.01 to \$50.00; 25c for parcels from \$50.01 to \$100.00. All parcels we ship are insured. EXPRESS INSURANCE rates are: for shipments under \$50.00, no extra insurance charge; for shipments valued from \$50.01 to \$100.00 charge is 10c. For each additional \$100.00 value or portion thereof, charge is 10c.

EXPRESS & FREIGHT SHIPMENTS

Express and freight shipments are sent transportation charges collect. If your station has no agent, please send sufficient money to cover transportation charges at the time order was made. All overpayments are promptly refunded.

C. O. D. SHIPMENTS

Transportation charges on C.O.D. parcels are slightly higher than those sent prepaid. C.O.D. charges in addition to the regular postage costs outlined above are as follows (including insurance): When value of parcel is up to \$2.50 the extra charge is 10c; \$2.51 to \$5.00 the extra charge is 20c; \$5.01 to \$10.00 the extra charge is 30c; \$10.01 to \$25.00 the extra charge is 40c; \$25.01 to \$50.00 the extra charge is 50c; \$50.01 to \$100.00 the extra charge is 60c; \$100.01 to \$200.00 the extra charge is 70c. The Post Office also charges a money order fee on each C.O.D. parcel. Save these fees by remitting in full.

NOTE: Equipment built or ordered especially to meet customer's requirements may be subject to exchange, credit or refund. All orders for special merchandise must be accompanied by a deposit.