

THE WORLDS GREATEST RADIO, TV and HI-FI CENTER

LAFAYETTE

1956

MONEY SAVERS!

Leaders in Transistors, Circuit Kits & Components

HI-FI EQUIPMENT

AMPLIFIERS TUNERS

RECORD PLAYERS & PICKUP ARMS CARTRIDGES TAPES

OPTICAL EQUIPMENT

BINOCULARS TELESCOPES

MICROSCOPES DRAFTING SETS CAMERAS

MICROPHONES & ACCESSORIES

TRANSISTOR CIRCUIT KITS & COMPONENTS

ANTENNAS & ACCESSORIES

Lafayette Radio

To Speed Shipment on Your Order Please Mention
CATALOG 556
 Remit by Check or Money Order. Include sufficient money for Postage. We Refund unused amounts.

NEW YORK, N.Y.	100 Sixth Ave.
BRONX, N.Y.	542 E. Fordham Rd
NEWARK, N.J.	24 Central Ave.
PLAINFIELD, N.J.	139 West 2nd St.
BOSTON, MASS.	110 Federal St.

New

3 WAY LONG RANGE SUPER PORTABLE



25 95

Packed with more features than have ever before been engineered into one set.

- **3 WAY OPERATION:** Operates on 110V AC, 110V DC, or self-contained batteries
- **DUAL ANTENNA SYSTEM:** Has both a highly sensitive built-in ferrite-rod-loop antenna for normal operation and a disappearing sectional antenna for bad locations, weak stations and distant reception.
- **DUAL LISTENING SYSTEM:** Has built-in speaker for group listening, plus "SILENT" listening for two people to hear with personal earpieces.
- **SUPERHET CIRCUIT:** Highly selective and sensitive superhet circuit with five tubes plus selenium rectifier. Plenty of power.
- **STYLING:** One of the most attractive sturdy plastic cases you've ever seen. Glistening Ivory and Lucite with Silver lettering.

3-WAY LONG RANGE SUPER PORTABLE

We believe we have set a new high in quality and in features with this set. It is different than any other ever offered anywhere. The dual antenna system is unique. You get all the fine reception of the ferrite rod antenna, plus the extra sensitivity provided by a 5 section collapsible chrome plated steel antenna that extends to 29 inches. When you travel into weak signal areas, distant spots, or areas where conditions for reception are poor, just pull out the auxiliary antenna and hear the difference! The auxiliary antenna is mounted on a rotating hinge in one corner of the case and may be extended either horizontally or vertically thru the outlets provided at top and side. When not in use it folds back inside the case. The dual listening system is also unique. You may operate the set in the usual manner on its own built-in speaker for group listening, but if you want to listen alone without disturbing anyone else, just flip a switch that cuts out the speaker and plug in the earpiece! Then only you can hear. The feather-weight earpiece fits snugly and comfortably in the ear. The set has two sets of jacks, so with an additional plug-in earpiece, two people can listen "silently." The three way operation is for batteries 110V AC or 110V DC current. When you plug-in the line cord you automatically

disconnect the batteries. The superhet circuit is sensitive, selective and powerful and incorporates five tubes plus a selenium rectifier. The case bespeaks the quality of the entire set. Made of gleaming sturdy ivory plastic, beautifully styled with clear lucite dials and silver lettering. It has a lay-flat carrying handle, and a hinged back to make replacement of batteries quick and simple. Size is 7 7/8" L x 5 1/4" H x 2 1/4" D. Net Wt., 4 lbs. Shpg. wt. with batteries 7 lbs. You'd pay \$10.00 more for this set if made in this country.

FS-102 — 3 WAY PORTABLE, Complete with tubes and 1 earpiece, less batteries Net **25.95**

ACCESSORIES

MS-276 — EXTRA EARPIECE WITH PLUG Net **1.75**
 BURGESS P45M — B Battery Net **2.54**
 BURGESS #2 — A Battery Net **.10**

ALL TRANSISTOR PORTABLE SUPERHET RADIO

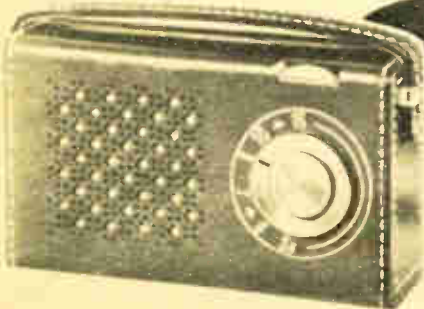

37 50

- COMPLETELY TRANSISTORIZED — USES NO VACUUM TUBES
- GENUINE TOP GRAIN LEATHER CASE
- USES ONLY 1 SMALL SELF-CONTAINED BATTERY
- BUILT IN ALNICO V SPEAKER
- BUILT IN ANTENNA

Lafayette is first to bring you a completely transistorized superhet portable at a price you can afford. Transistors mean long life and economy of operation not possible with vacuum tube circuits. The circuit using 4 transistors and a germanium diode is operated by a single battery that gives approximately 200 hours of average use. Superhet design gives great selectivity and built in ferrite antenna insures high sensitivity. Transformer coupling gives smooth, high gain signal to the alnico V PM speaker. You'll appreciate the tone quality and power of this set. The case is of attractive saddle-colored top-grain leather. Handy tuning dial and recessed volume control with on-off switch. It covers the entire broadcast band. The small size enables you to carry it about with you or tuck it in your auto glove compartment. Measures only 1 3/4" D x 3 3/4" H x 5 3/4" L, and weighs only about 1 lb. Shpg. wt., 1 1/2 lbs.

IN586 (less battery) Net **37.50**
 Burgess 2N6 Battery Net **1.19**

The First Really New Idea In Portable Radios In 20 Years

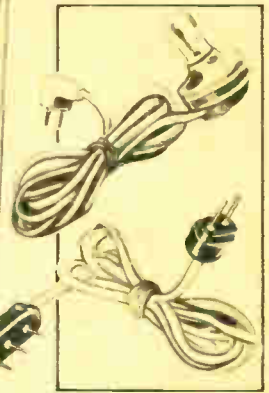
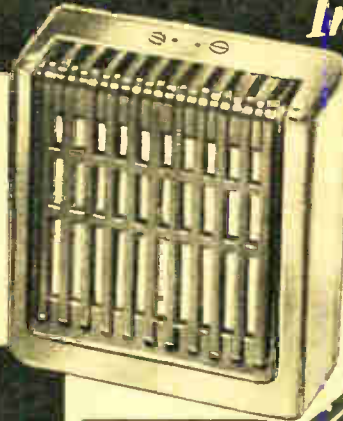

THE
LAFAYETTE
NOVELETTE
17.95



COMBINATION SUPER HET POCKET & HOME RADIO

- **FOR GROUP LISTENING:** The Novelette has its own plug-in extension speaker
- **FOR PRIVATE LISTENING:** It has a separate plug-in earpiece so you alone can listen

The Lafayette Novelette is the finest handiest little portable set you can buy. Because the speaker is in its own properly baffled case free from the space limitations of self-contained speakers, the tone quality is superb. A 3 1/2 ft. extension cord enables the speaker to be placed conveniently wherever desired so all can hear. When you want to listen "silently" without disturbing anyone else, you simply plug in the personal earpiece in place of the speaker. It is therefore ideal for both home use or to take with you on picnics, camping, or wherever you go. It slips right into your pocket. The

- **POCKET SIZE:** The set measures only 5 1/2" L x 3 1/8" H x 1 1/2" D.
- **SEPARATE SPEAKER:** Superb "one quality. Case measures 2 3/8" W x 3" H x 1 3/8" D.
- **BEAUTIFULLY STYLED:** Handsome maroon plastic case with clear lucite dial with silver lettering

circuit is very selective, sensitive, and powerful using 4 tubes with built-in antenna. The Novelette comes complete with tubes, speaker and earpiece. Less batteries. Shpg. wt. 3 lbs.

FS-100 — LAFAYETTE NOVELETTE	Net	17.95
Requires 1 — Burgess U30	Net	1.75
Requires 1 — Burgess #1	Net	.10

New!



Powerful Superhet Pocket Radio SENSITIVE SELECTIVE BUILT IN ANTENNAS

- **TRULY PORTABLE:** Only 5 1/2" x 3 1/4" x 1 3/8". Weighs only 14 Oz. with batteries
- **TRULY PERSONAL:** Has built-in private earpiece so only you can hear
- **POWERFUL-SELECTIVE:** Power, sensitivity and selectivity that only a vacuum tube superhet circuit can give

Here is a personal portable radio that will amaze you with its performance at a price that cannot be matched anywhere. It is compact, measuring only 5 1/2" L x 3 1/4" H x 1 3/8" D and weighs only 14 oz. complete with batteries. It comes complete with a highly efficient earpiece that fits snugly and comfortably in your ear so you can listen wherever you may be without disturbing anyone else. It has the power and selectivity that is still possible only with a vacuum tube superhet circuit. It is entirely self-contained, batteries fit inside case. The plastic case is attractively designed with lucite control knob and a dial with gold lettering. You'll be delighted with the performance of this set. Set is complete with earpiece but less batteries. Available in either Ivory or Red. Specify color. Shpg. wt. 2 lbs.

FS-101 (less batteries)	Net	11.95
BATTERIES		
Requires 1 — Burgess U30	Net	1.75
Requires 1 — Burgess #1	Net	.10

LAFAYETTE HI-FI FM-AM PHONO COMBINATION

WITH 2 WAY SPEAKER SYSTEM INSTALLED IN HANDSOME CABINET AND INCLUDING NEW COLLARO RC-456 4-SPEED INTERMIX CHANGER EQUIPPED WITH GE-RPX-052A DIAMOND AND SAPPHIRE TURNOVER CARTRIDGE

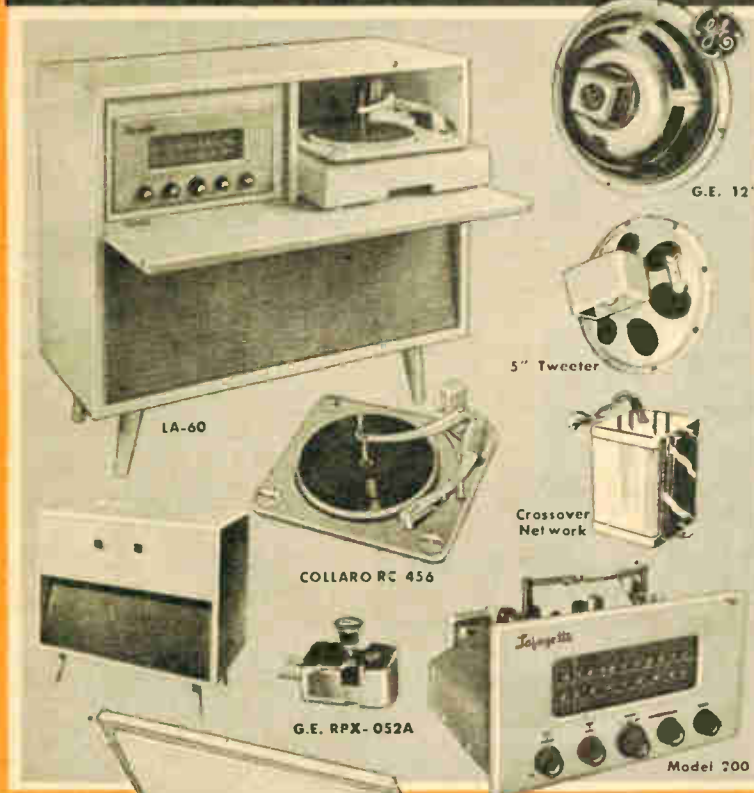

For those who want a completely matched and wired FM-AM Phono System, Completely installed in Handsome Console Cabinet, Lafayette presents this new model Radio Phono Combination. Contains everything you need for brilliant music reproduction. The attractive Console combines graceful styling with true functional design. Equipped with the Model 200 DeLuxe FM-AM receiver chassis (13 tube plus rectifier), with 10 watts of push-pull amplification and preamplifier. Has a dual control to compensate for Long Playing, AES, or European recordings. The record changer is the famous new Collaro Model RC-456 4-speed intermix record changer equipped with G.E. RPX-052A diamond and sapphire Triple Play variable reluctance cartridge. Also includes a 2-Way Speaker System consisting of a G.E. 12" — 25 watt PM Speaker acting as "Woofers" and a 5" Tweeter with Crossover Network. The Tweeter, or treble speaker reproduces treble notes, overtones and harmonics with remarkable richness and "presence". This is super-value in custom Hi-Fi Radio Phono combinations which outperforms commercially assembled radiophonos costing several times its price. The console is 32 1/4" H, 35 1/2" W, 15 7/8" Deep. For 110-120 V, 60 cycle AC operation. Shpg. wt., 155 lbs.

- Model LA-62—Complete in Unfinished Console Cabinet Net **229.50**
- Model LA-63—Complete in Mahogany Finish Console Cabinet Net **244.50**
- Model LA-63—Complete in Blonde Finish Console Cabinet Net **244.50**
- CAB-10 Unfinished Cabinet Net **69.50**
- CAB-11 Mahogany finish cabinet Net **86.50**
- CAB-12 Blonde finish cabinet Net **86.50**

\$229.50 Complete



124.50

An Exquisite Phono For Music Lovers

LAFAYETTE

• HI-FI-PHONOGRAPH •

- NEW COLLARO 4 SPEED AUTOMATIC RECORD CHANGER
- 2 WAY SPEAKER SYSTEM WITH CROSSOVER NETWORK
- WITH G.E. VARIABLE RELUCTANCE PICKUP RPX-050A
- LAFAYETTE PUSH PULL HI-FI AMPLIFIER

A complete high-fidelity consolette phonograph which cannot be appreciated until you see it and hear it. A rare opportunity for the Music Lover who has always wanted an exquisitely, compactly designed cabinet (measures 25 1/2" H, 16" D, 25 1/2" W) and get tons reproduction that surpasses instruments considerably larger and bulkier and costing many times more. In the Lafayette Model PH-55 you get a multitude of features including the Lafayette LA-20 push-pull Hi-Fi amplifier which was especially designed for the Audio Hobbyist and Music Lover; the newest model Collaro RC-456 automatic 4-speed intermix record changer — noted for its high-fidelity performance and equipped with the G.E. RPX-050A variable reluctance magnetic pickup. Has a 2-way Speaker System and Crossover Network, consisting of an 8" PM heavy duty G.E. 12 watt speaker with 6.8 oz. Alnico V magnet acting as a "woofers", plus an especially designed 5" PM tweeter and crossover network to increase the high fidelity range up to 15,000 cycles, housed in an acoustically designed enclosure for maximum high quality performance. Clean, smooth reproduction, with an unmistakable presence of the 2-way speaker reproducer—will recreate a tone balance which is unbelievable. Cabinet is finely constructed of choicest hardwoods, is hand rubbed in the tradition of fine furniture. Available in mahogany, blonde finishes. An ideal Phono for a small room in a hotel or apartment. The finest phonograph available in design, quality of components, performance and Value. Shpg. Wt. 75 lbs.

PH-55 (specify finish) Net **124.50**

• HIGH QUALITY **H-F** at *Low* **Low** PRICES •

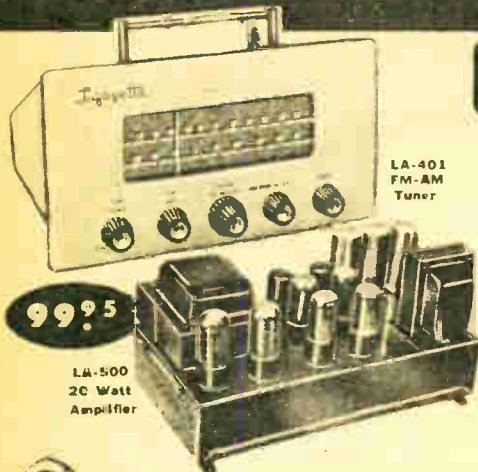

LAFAYETTE DE LUXE MODEL LA-401 FM-AM TUNER and 20 WATT HI-FI AMPLIFIER COMBINATION MODEL LA-500

MODEL LA-401 FM-AM TUNER

The Lafayette Deluxe Model LA-401 FM-AM Tuner and the Lafayette Model LA-500 20 WATT Hi-Fi Amplifier combination. This combination offers deluxe FM-AM reception and unusually fine phono reproduction. Two separate chassis assure exceptional performance without hum—one chassis includes FM-AM tuner; the other includes power supply and 20 WATT Hi-Fi Audio Amplifier. It is rugged, sturdy construction using high quality components, professionally designed to blend into any home surroundings, whether installed in a cabinet, console or a bookcase. **SALIENT FEATURES:** The Model LA-401 incorporates an improved frequency modulation circuit that is drift compensated tubes, automatic frequency control; 8-gang tuning condensers; tuned RF amplifiers to make use of low field strength signals; pre-amplifier for use with reluctance type phonograph pickup cartridges; output from detector to jack on rear; a ferrite loopstick antenna for AM and a line cord antenna for FM reception; full use of dual purpose tubes to obtain maximum performance; full range bass and treble tone controls with 18 db range; auxiliary position on switch for audio input; two line power outlets; automatic volume control; provision for external antenna; special control for balancing out residual line frequency hum; easy flywheel tuning combined with an attractive, easily readable "slide-rule" edge-lighted dial; dual control which operates a record roll-off equalizer network to compensate for recording characteristics in long-playing, AES or European recordings. The LA-401 tunes from 5.35 to 17.20 Mc on AM and from 88 to 108 Mc on FM. Outside antennas are usually not needed. The set is manufactured under license from RCA and Hazeltine and is RTMA listed code #174. Technical Performance Data — Sensitivity: AM: 75 microvolts per meter (ferrite loopstick antenna) for 6 db S/N ratio, FM: 8 microvolts required for 30 db quieting. Selectivity: AM: 10 Kc; 9 db, FM: 210 Kc; 6 db. **RATIO DETECTOR** peak to peak bandwidth: 40 Kc. Audio output impedance: high impedance amplifier grid input circuit (to be used with LA-500 Amplifier and Power Supply). Audio Frequency response: ± 3 db, 20-15,000 cps. **TUBE COMPLETEMENT:** 12 tubes: 6BA6 AMRF Amplifier; 6BA6 FMRF Amplifier; 6BE6 AM Oscillator and Mixer; 6BA6 IF Amplifier; 6AU6 FM Detector Driver; 6AL5 FM Detector; 6C4 FM Os. Filter; 6BE6 FM Mixer; 6C4 AM Detector; 6AV6 1st Audio Amplifier; 12AX7 Tone Control Amplifier; 12AX7 Phono Pre-amp. **DIMENSIONS AND WEIGHT:** Chassis is 13 1/2" W, 7 1/2" H and 10" D. Shpg. Wt. 12 lbs. Operates at 105-125 Volts AC 50-60 cycles, power consumption 135 watts.



LAFAYETTE MODEL LA-500 HI-FI 20 WATT AMPLIFIER

AUDIO AMPLIFIER: A deluxe power supply and audio amplifier designed specifically for use with the Model LA-401 Tuner pictured above. However, this unit may be used wherever a high quality audio amplifier is required. Operates at 105/125 Volts AC, 50/60 cycles, with a power consumption of 135 watts when used in conjunction with the Model LA-401. **SALIENT FEATURES:** The Model LA-500 incorporates a parallel push-pull beam power output circuit; self-balancing phase inverter system; extended range high-fidelity response is obtained through use of specially designed output transformer combined with an inverse feedback circuit; the selected output impedance for speaker requirements are 4, 8, 15, 250 and 500 ohms. The unit is manufactured under license from RCA and is RTMA listed Code #174. It is supplied ready to operate. **TUBE COMPLETEMENT:** 6 tubes: 6J5 Audio Driver; 6J2 Phase Inverter; four 6V6/GT Beam Power Audio Output; two 5Y3 6T Rectifier. **DIMENSIONS AND WEIGHT:** Chassis is 13 1/2" wide, 7 1/2" high and 9" deep. Shpg. wt. 18 lbs.

LAFAYETTE Model LA-401 FM-AM Tuner and LAFAYETTE Model LA-500 20 Watt Amplifier complete with tubes and all necessary hardware. **NET 99.95**

COMPLETE HI-FI SYSTEM COMBINATION DEAL

This extraordinarily fine high fidelity system revolves around the deluxe model LA401 AM-FM Tuner and Model LA500 20 watt amplifier combination. In addition, the system contains the new Collaro 4-speed intermix record changer model RC 456 equipped with the **GE RPX-052A Triple Play Cartridge with diamond and sapphire styl** and the new University Model LXC 122 12" Diffusitone co-axial speaker, Superhet with plugs, jacks, cables and ready for quick and easy installation. Shpg. wt. 80 lbs.

HF-135—Complete System **Net 159.50**

Lafayette's DELUXE FM-AM RECEIVER CHASSIS

- 13 TUBES PLUS RECTIFIER
- PRE-AMP FOR RELUCTANCE CARTRIDGES
- DRIFT COMPENSATED
- HI-FIDELITY QUALITY



LAFAYETTE MODEL 200 DELUXE FM-AM RECEIVER CHASSIS

A DeLuxe Superheterodyne AM-FM Radio Receiver chassis designed to operate on 105/125 volt AC, 50/60 cycles. Incorporates an improved frequency modulation circuit that is drift compensated to eliminate the need for troublesome automatic frequency control circuits; 8 gang tuning condenser; high fidelity AM-FM reception; tuned RF amplifiers to make use of low field strength signals; a pre-amplifier for use with reluctance type of phonograph pickup cartridge; a Ferrite Loop Stick antenna for AM and a folded dipole for FM reception; AF input; line power outlets; auxiliary position on switch for when TT Audio is channeled through set; push-pull beam power audio amplifier; full range bass and treble controls; automatic volume control; provision for external antennas; matching networks for use with

either high or low impedance pickup; a special heater winding with a control for balancing out residual line frequency hum; multistap output transformer to match 4, 8 and 500 ohms. Has a dual control which operates a record roll-off equalizer network to compensate for recording characteristics in long playing, AES or European recordings. Tunes from 535 to 1720 Kc on AM, and from 88 to 108 Mc on FM. Has 13 tubes plus a rectifier. Tube complement is (3) 6BA6, (2) 6BE6, 6AL6, 6AL5, 6C4, 6AV6, 12AX7, 12AT6, 6AX7, (2) 6V6/GT and 5Y3GT Rectifier. Supplied ready to operate complete with tubes, antenna, and all necessary hardware. Chassis is 13 1/2" wide x 7 1/2" high x 10" deep. Weight 17 1/2 lbs each.

LAFAYETTE MODEL 200.....NET 79.50

A COMPLETE HI-FI AM-FM PHONO-RADIO COMBINATION

A delightful high-fidelity FM-AM radio-phonograph combination can be assembled around the deluxe 13 tube (plus rectifier) FM-AM receiver chassis which combines many important features and quality construction to assure excellent performance. The ensemble features the newest Collaro 4-speed intermix record changer Model RC 456 equipped with the **GE RPX-052A Diamond and Sapphire Cartridge**. Full-bodied undistorted response is provided by the new 12" University co-axial speaker Model LXC 122. These matched components assure clean, crisp wide-range reproduction. All unit supplied complete with plugs, jacks, cable and hardware — ready for quick and easy installation. Shpg. wt. 80 lbs.



139.50

HF-136—Complete system.....Net 139.50

The Improved Lafayette LA 54A HIGH FIDELITY AMPLIFIER

The answer to ALL Audio Amplifier Needs

AN OUTSTANDING ENGINEERING ACHIEVEMENT WHICH ONLY LAFAYETTE CAN BRING TO YOU . . .

... AND ALL AT THIS UNBEATABLE PRICE!

EMPLOYS FEATURES FOUND ONLY IN MOST EXPENSIVE AMPLIFIERS



- INDIVIDUAL LOUDNESS AND RUMBLE FILTER CONTROLS
- SEPARATE ADJUSTABLE TURNOVER AND ROLL-OFF FACILITIES AFFORDS 24 POSSIBLE PLAYBACK CURVES
- INFINITE SELECTION OF TONE COMPENSATING ADJUSTMENTS WITH INDIVIDUAL BASS AND TREBLE CONTROLS
- REDUCED INTERMODULATION DISTORTION AT ALL LISTENING LEVELS — AT LOW AS WELL AS AT HIGH OUTPUTS
- INCORPORATES ADVANCED PRINTED CIRCUIT TECHNIQUES
- SPECIAL TAKE-OFF JACK FOR RECORDING ON TAPE

Lafayette quality engineering utilizes the latest techniques in printed circuitry to produce this modern, streamlined high fidelity amplifier with features characteristic of the best amplifiers. This unit is so complete that its listening quality is the equal of amplifiers many times its size and weight . . . yet at a fraction of the cost! Consider these specifications, make your own comparisons and draw your own conclusions.

CONTROLS: SELECTOR (and TURNOVER CONTROL), 7 Positions: TV, Tape, Radio and 4 phonograph positions for AES, RIAA, 800 and LP. **ROLL-OFF:** 6 positions of high-frequency record compensation: NOISY—LP—RIAA—AES—5 —FLAT. **RUMBLE FILTER:** ON-OFF. Eliminates low frequency extraneous mechanical noises. **LOUDNESS CONTROL:** ON-OFF. Prevents loss of bass and treble frequencies at low volume levels. **BASS:** Continuous control 16 db boost to 16 db cut at 50 cycles, "flat" position marked. **TREBLE:** Continuous control 12 db boost to 15 db cut at 10,000 cycles, "flat" position marked. **POWER OUTPUT:** 12 Watts, 24 Watts peak at 1% harmonic distortion, 5 watts 1% intermodulation distortion, 3 db power rating, 30 to 20,000 cycles. **INPUTS:** TV-Sound, Radio and Tape inputs: 1/2 megohm impedance, Phonograph inputs: 47,000 ohms for magnetic and dynamic cartridges. Built-in equalizer for use of ceramic, FM (capacitance) and crystal pickups, adjustable equalization effective on all types of pickups. **FREQUENCY RESPONSE:** 20-20,000 cycles ±1 db. **SENSITIVITY:** (Gain Factors) 8 millivolts at magnetic phono input required for 12 watts output, 0.3V required at Tuner, Tape, TV inputs for 12 watts output. 42 db gain between magnetic — phono input and tape take-off jack. 10 db gain between Radio, Tape, TV inputs and tape take-off jack. **OUTPUT IMPEDANCES:** 4, 8, and 16 ohms. **DAMPING FACTOR:** 15. Source impedance much lower than internal resistance of loudspeaker. **FEEDBACK:** Four negative feedback loops virtually eliminate distortion. 20 db feedback around voltage and power amplifier stages. **QUIETNESS:** Noise plus hum 75 db below maximum output on Radio, TV, Tape inputs 70 db below maximum output on phono input. (54 db below effective program level with 10 millivolt input). **TAPE TAKE-OFF JACK:** Provides output of sufficient level to drive any tape recorder. Independent of volume control setting. **TUBES:** Six in all doing the work of nine. No difficult-to-locate or special types used. 3-12AX7, 2-6AQ5, 1-6X4. **POWER OUTLET:** 110V for tuner, record player etc. controlled by on-off switch. **DIMENSIONS:** Only 4 1/2" high, 10 1/2" long and 8" deep from front panel to clearance over jacks on back panel. Shpg. wt., 12 lbs. **MODEL LA-54A** Net 59.50

A COMPLETE SOURCE SELECTING, AUDIO AMPLIFYING, AND TONE COMPENSATING UNIT DESIGNED TO MEET THE HIGHEST STANDARDS OF HIGH FIDELITY REPRODUCTION.

GUARANTEED TO OUTPERFORM ANY AMPLIFIER IN ITS PRICE RANGE OR YOUR MONEY BACK

A HIGH FIDELITY SYSTEM WITH UNSURPASSED PERFORMANCE

This thoughtfully matched custom high-fidelity music system provides undreamed of realism and faithfulness of reproduction of broadcast or recorded music. You can now listen to music as you have never before heard it. The system consists of the world-famous latest model COLLARO RC-456 4-SPEED INTERMIX RECORD CHANGER with GE RPX-052A DIAMOND AND SAPPHIRE TURNOVER CARTRIDGE; the newly designed PEDERSEN AFM-2A BASIC TUNER featuring separate AM and FM front ends; the improved famous LAFAYETTE LA-54A 12 WATT HI-FI AMPLIFIER whose features are found only in the very best amplifiers; and the new UNIVERSITY MODEL UXC 123 12" TRIAXIAL DIFFUSICONE SPEAKER. Phenominal bass response, full-bodied middle register and silky-smooth response to the highest audible frequencies provide perfect balance and an undistorted listening experience. All units are supplied with plugs, jacks and prepared cables which simply plug into each other — ready for quick and easy installation. The attractive finishes of the units blend beautifully with all decorative schemes. Shpg. wt. 65 lbs.

- | | | |
|--------|---|------------|
| HF-129 | Complete system, less cabinet for tuner | Net 254.50 |
| HF-130 | Same system as above with new Fairchild Model 225 "Micro-just" Diamond LP cartridge | Net 267.50 |
| HF- | Cabinet for Pedersen Tuner | Net 15.00 |



A PHONO SYSTEM TO DELIGHT THE MUSIC LOVER

This is the first time that a high-fidelity phono system of such quality has been offered — and at a down-to-earth price. This system consists of the latest Collaro Model RC-456 4-Speed Intermix Record Changer with GE-RPX-052A Diamond and Sapphire Turnover Cartridge; the famous improved Lafayette LA-54A 12-watt amplifier with superlative hi-fi performance; the new University Model UXC 122 12" two-way Diffaxial Speaker permitting full undistorted response without loss of highs at listening points progressively off speaker axis. The result of this fortunate combination of components is truly full fidelity anywhere in the room. Here is a system having low distortion and reserve power to spare. There are 24 combinations of record equalization. This system is designed without compromise to deliver realistic audio reproduction. Complete with all plugs, cables and hardware, ready for simple installation. Shpg. wt., 48 lbs.

- | | | |
|---|-----------------|------------|
| HF-131 | Complete System | Net 123.95 |
| SYSTEM WITH NEWEST FAIRCHILD DIAMOND LP CARTRIDGE. Same system as above with latest Fairchild Model 225 "Microjust" Diamond LP cartridge. | | |
| HF-132 | | Net 136.95 |

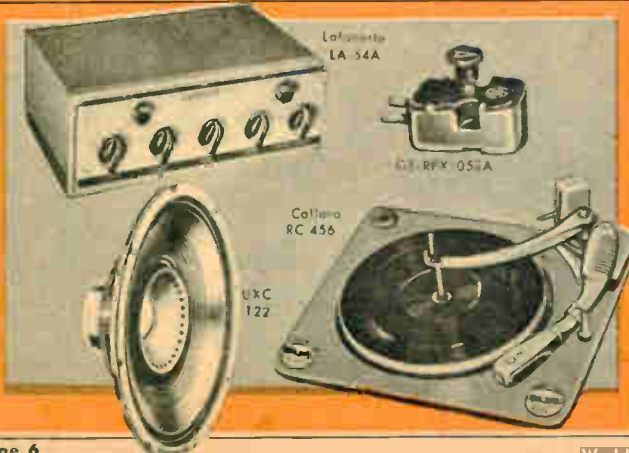

20 WATT HI-FI FM-AM PHONO SYSTEM! NEW! an OUTSTANDING value!

WITH GARRAD 3 SPEED CHANGER AND GE DIAMOND AND SAPPHIRE CARTRIDGE



LA-25
20 Watt
Amplifier
\$64.50

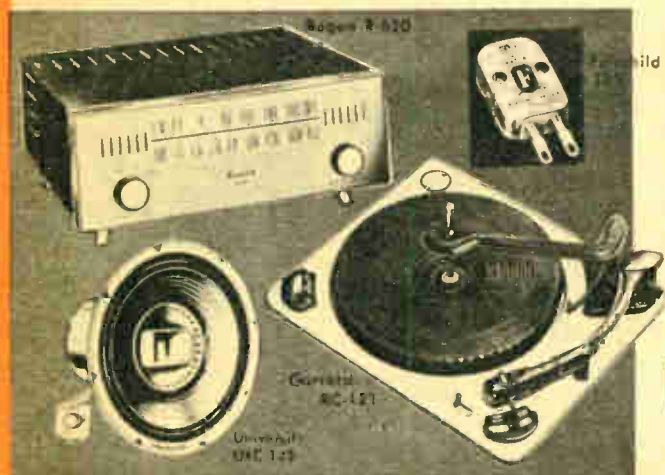

- 24 POSITIONS OF RECORD COMPENSATION
- FREQUENCY RESPONSE 15 to 30,000 CPS
- FEEDBACK AROUND EVERY STAGE FROM INPUT TO OUTPUT
- 1.0% HARMONICS AND 2.0% OR LESS INTERMODULATION DISTORTION AT 20 WATTS

New, compact amplifier achieving wide frequency response with very low distortion by the use of feedback loops in every stage. Separate turnover and roll-off provide 24 positions of record compensation. **POWER OUTPUT** — 20 watts; 30 watts peak. **POWER RESPONSE** — ± 1 DB 27 to 20,000 CPS at 20 watt level. **CONTROLS:** 7 controls. **SELECTOR:** for tape, radio and 4 phono turnover positions; **ROLL OFF:** 6 positions; **LOUDNESS:** for automatic frequency balance at low level listening; **LEVEL:** On-Off and Volume Control; **BASS:** calibrated from -15 DB to +15 DB of 50 CPS; **TREBLE:** calibrated from -15 DB to +15 DB at 10,000 CPS; **RUMBLE FILTER SWITCH.** **INPUTS:** Five. Radio and tape channels — .5 megohm each. Magnetic phono No. 1 — 44,000 ohms for GE, Fairchild etc. Magnetic phono No. 2 — 22,000 ohms for Pickering, Phono No. 3 — for crystal, ceramic or Weathers. **OUTPUTS:** 4, 8 and 16 ohms; high impedance jack for feeding tape recorder. **SENSITIVITY:** Radio and tape channels, 4 volts and magnetic pickup channel requires .008 volts for 20 watts output. **HUM AND NOISE:** 80 DB below 20 watts output (radio channel). **TUBES:** 3 — 12AX7, 2 — 58B1/6L6GB, 2 — 5Y3GT. **NEGATIVE FEEDBACK:** Complete stability from four separate loops. Main loop around output transformer gives 18 DB resulting in low output impedance. **SQUARE WAVE RESPONSE:** Excellent with all frequencies. No ringing or oscillation even with capacity load at output terminals. Fully enclosed for table top and shelf use with easily removable control panel for cabinet installation. In handsome charcoal and gold finish. Size 12" wide x 10" deep x 4 3/4" high. Shpg. wt., 20 lbs.

LA-25 . . . 20 Watt Amplifier Only Net **64.50**
An unusual complete FM-AM Phono music system results from this extremely fortunate and popular combination of high-fidelity components. The design features of this fine system provide excellent audio fidelity and smooth dependable performance. This system includes the new LA25 20-watt compact and versatile amplifier that far exceeds the most critical requirements; the Garrad Model RC-121 "Reknaw" 3-Speed Automatic Manual and Inter-mix Record Changer equipped with GE RPX-052A Triple Play Cartridge with diamond LP and standard sapphire stylus; the new Bogen R-620 FM-AM tuner boasting a very high selectivity and extreme sensitivity and featuring easy, precise tuning; and the new University Model UXC-123 Triaxial Speaker offering thrilling wide-range performance and featuring "reciprocating flares" horn tweeter. The complete system with plugs, cables, etc., and ready for quick easy installation. Shpg. wt., 56 lbs.

HF-133 . . . Complete system, less tuner enclosure 222.50

SYSTEM WITH NEW FAIRCHILD MODEL 225 "MICRADJUST" DIAMOND LP CARTRIDGE

The same system as above but with newest Fairchild Model 225 "Microadjust" Diamond LP cartridge.

HF-134 . . . Complete System, less tuner enclosure 237.50
ACB (Blonde) or ACM (Mahogany) Metal enclosure with legs for tuner 7.00

FISHER AUDIO EQUIPMENT

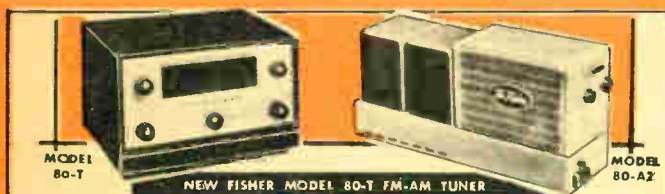

MODEL 80-T

NEW FISHER MODEL 80-T FM-AM TUNER

MODEL 80-AZ

The taste of professionals, the New Fisher FM-AM Tuner, Model 80-T provides a level of performance that far exceeds the most critical specifications. FM-AM: 2 professional, micro-accurate tuning meters; dual antenna inputs; separate front ends. AM: Two adjustable band-width F stages, 10 kc whistle filter. FM: Cascode tuned RF stage for maximum signal to noise ratio; Two IF stages followed by 2 cascaded limiters and a Foster-Seeley Discriminator. Adjustable AFC: 20 to 20,000 cycles ± 5 db frequency response. Has complete professional control facilities on separate inter-locked chassis with exclusive, separate tape head playback preamplifier, equalized to NABTB; Preamplifier-Equalizer that has adjustable gain for lowest magnetic pickup; six record equalization settings; variable crossover-type Bass and Treble Tone controls. 20 to 20,000 cycle ± 5 db frequency response; two cathode follower outputs; self-powered; eight controls—Bass, Treble, Equalization Selector, Volume, Loudness Balance, AFC/Power, Channel Selector and Station Selector. Tube complement: 2-6BQ7A, 1-6T6, 1-6BE6, 1-6AU6, 1-6AL5, 2-12AX7, 2-6BJ6, 3-6C4, 2-6U8, 1-6X4. Dimensions: 12 3/4" W, 8 3/4" D, 6" H. Shpg. Wt. 21 lbs. Fisher 80-T Net 199.50

THE FISHER FM-AM TUNER MODEL 80-R

The Model 80R is identical to the Model 80-T, but is designed for use with an external Preamplifier-Equalizer such as the Fisher 80-E. Dimensions: 12 3/4" W, 8 3/4" D, 4" H. Shpg. wt., 16 lbs. Fisher 80R Net 169.50

THE FISHER MODEL 80 FM

The Fisher FM 80 combines startling sensitivity, compact design and micro-accurate tuning. Two tuning meters—one indicates signal strength, and the other shows when station is tuned properly. Armstrong system, dual limiters and cascode R.F. stage provides extreme sensitivity. Frequency response ± 1 db 20—20,000 cycles. Variable automatic Frequency control and two cathode-follower outputs. Convenience 0 to 100 logging scale; 10 tubes and 634 rectifier; 4 1/2" x 12 3/4" x 7 1/2" deep. For 105, 125 V., 50-60 cycle AC. Shpg. Wt. 15 lbs. Fisher FM-80 Net 139.50

THE FISHER 80-C MASTER AUDIO CONTROL



A PREAMPLIFIER EQUALIZER HAVING FULL MIXING AND FADING FACILITIES WHICH CAN BE USED WITH ANY AMPLIFIER

• Professional, lever-type equalization for all current recording characteristics. • Seven inputs, including two Phono, Mic and Tape. • Two cathode-follower outputs. • Complete mixing and fading on two, three, four or five channels. • Bass and Treble Tone Controls of the variable-crossover feedback type. • Accurately calibrated Loudness Balance Control. • Self-powered. • Inherent hum: non-measurable. (On Phono, 72 db below output on 10 mv input signal; better than 85 db below 2v output on high-level channels.) • IM and harmonic distortion: non-measurable. • Frequency response: uniform 10 to 100,000 cycles. • Separate equalization and amplification directly from tape playback head. • Four dual-purpose tubes, all shielded and shock-mounted. • Separate, high-gain microphone preamplifier. • Push-Button Channel-Selectors with individual indicator lights and simultaneous AC On-Off switching on two channels (for tuner, TV, etc.). • Master Volume Control plus 5 independent Level Controls on front panel. • 11 Controls plus 5 push-buttons. • Three auxiliary AC receptacles SIZE: Chassis, 12 1/2" x 7 3/4" x 4 1/4" high. In cabinet, 13 1/2" x 8" x 5 1/4" high. Shipping weight, 10 lbs. Chassis only **\$79.50** Mahogany or Blonde Cabinet. **\$9.95**

NEW FISHER MODEL FM-40 FM TUNER



The FM-40 is a superb combination of engineering excellence and dazzling performance in a professional FM tuner at a moderate cost. This self-powered unit, with chassis completely shielded and shock-mounted has a cascode RF and 3 IF stages. It features a sensitivity of 3 UV for 20 db of quieting and has a uniform response of ± 1 db from 20 to 20,000 cycles. A meter permits micro-accurate, center-of-channel tuning. Two controls: AC Power/Volume and Station Selector. Two Outputs: Detector/Multiplex (on switching) plus cathode-follower type Main Audio, permitting leads up to 200 feet. 8 tubes. Heavy flywheel tuning mechanism and convenience 0 — to — 100 logging scale. Handsome brown and gold brushed brass finish. 4" x 12 3/4" x 8 3/4" deep. Shpg. wt., 15 lbs.

FISHER FM-40, less cabinet, Net 99.50
Mahogany or Blonde cabinet Net 14.95

LaCajette

BOGEN HIFI EQUIPMENT

LEADERS



BOGEN R660 FM-AM TUNER

Extremely sensitive and highly stable on FM and AM, new AFC circuitry provides lighter oscillator frequency control and insures continuous distortionless output. Provision for balanced 300 ohm input, as well as shielded 70 ohm input. This insures improved sensitivity and greater freedom from ignition and other interference. Also built-in line antenna for strong signal areas. AVC on FM insures proper selectivity, and avoidance of strong station interference in very strong signal areas. Double limited and Armstrong discriminator provides full limiting on very weak signals. Tuning meter on both AM and FM makes possible simple and easy tuning in for minimum noise and distortion. Available in chassis form or in handsome metal enclosure. Tubes used: 2 each 6BA6 and 6AU6; 1 each 12AT7, 6X4, 6H7, 6BE6, 12AU7 and 6X4 rectifier. Sizes 12" x 11" x 5 1/2". For 110-125 Volt AC operation. Shpg. wt. 17 lbs.

R-660 less enclosure **NET 119.50**
ACB (Blonde) or ACM (Mahogany) metal enclosures with legs **Net 7.00**

FM 50 HI-FI FM TUNER

A superb tuner that is comparable to Model R660 that covers only the FM band. **FM 50**
ACB (Blonde) or ACM (Mahogany) enclosure with legs **Net 7.00**

NEW BOGEN R620 FM-AM TUNER

Here is a high fidelity tuner for those who require fine FM-AM music reproduction at a moderate cost. A remarkably effective AFC circuit, flywheel drive and lighted dial pointer assure easy precise tuning through the full FM and AM bands. The FM circuit features a built-in line cord antenna, triode RF and triode mixer for minimum noise, balance ratio detector and an AVC circuit which prevents overloading under strong signal conditions. The R620 accommodates both 300 ohm balanced and 70 ohm unbalanced external FM antennas and has a high "Q" AM ferrite loop antenna. There is only 2% distortion at 1 volt on both AM and FM. Has a tuning control and Selector with POWER OFF, AM, FM, and AFU DEFEAT positions. Frequency range from 88-108 MC on FM and 530-1620 KC on AM. FM sensitivity 10 UV required for 30 db quieting, AM, 5 UV required for 20 db quieting. FM Selectivity, 180 KC bandwidth, 3 db down, AM, 7KC bandwidth, 3 db down. The FM ratio detector has a peak-to-peak separation of 350 KC. Frequency response is ± 1 db 15-15,000 CPS. FM, and ± 3 db 15-3500 CPS. AM. Tube complement includes: 1-12AT7, 1-6BA6, 1-6BE6, 1-6AU6, 1-6X4 and 1-6X4. Power, 30 watts, 117 volts, 60 CPS. Dimensions - 12" wide x 11" deep x 4 3/4" high (5 1/2" high with ACB or ACM enclosure and legs). Shpg. wt. 11 lbs.

Model R620, less enclosure **Net 80.00**
ACB (Blonde) or ACM (Mahogany) Metal enclosure with legs **Net 7.00**



NEW BOGEN DB110— 10 WATT AMPLIFIER

The new Bogen DB110 offers an unusual value-performance and specifications are equal to amplifiers costing considerably more. Positive feedback circuit, New exclusive infinite damping factor control network, provides clearer bass response, permitting precise coupling of amplifier to the speaker system. With built in pre-amplifier giving 10 Watts output with only 0.65% harmonic distortion. Frequency response: ± 1 db, 15,000 cycles at 10 watts. Four inputs: Mic, Tuner, Phone and AUX (for TV, crystal phono or Tape

Recorder) 3 position record equalizer: LP (ORTHO, RIAA, AES) 78 and POP for old noisy records; BASS, Treble, Off-On-Volume; Output 4, 8 and 16 ohm. Tubes: 3-12AX7, 2-6V6GT, 5V3GT rectifier. For 110-120v, 60 cycle AC. Size 5 1/2" x 11" x 17 1/4". Shpg. Wt. 10 lbs.

BOGEN DB110—Less Cabinet. .Net 59.95

As above but housed in highly attractive gold and brown finish metal cabinet. Shpg. Wt. 14 lbs. **Net 64.50**

NEW BOGEN DB20 HIGH FIDELITY AMPLIFIER

The DB20 is a truly remarkable new amplifier featuring the most complete and versatile control of sound reproduction available today in a single chassis high fidelity model. A ten position Input Selector provides a choice of radio, television, tape, and seven different equalization curves for disc recordings. Has a built-in preamplifier for G. E. Pickering, Audax and similar magnetic pickups. Power output: 20 watts at 0.3% peak 30 watts. Frequency response: 20-20,000 c.p.s. ± 0.7 db Gain: Magnetic, 106 db, crystal and radio, 93 db. Tone corrector range: Bass control, +17 to -18 db at 40 cps; Treble control, +15 to -21 db at 15 KC. Output impedance:

8 or 16 ohms. Damping factor: 13. Record equalization positions (7): LP, AES, NAB, AMTR, EUTR, FRFR, POPULAR. Input Selector positions: Mag. phono, radio, TV, Tape, 5 loudness contour selector positions: Loud (flat), Loud (-10 db), Medium (-20 db), Soft (-30 db), Soft (-40 db). Power consumption: 117 volts, 60 c.p.s., 150 watts. Tubes: (3) 12AT7, (1) 12AU7, (2) 6L6G, (1) 5Y4 rect. Dimensions: 15" W x 9 1/2" D x 8" H. Wt. 25 lbs.

MODEL DB20. Amplifier and Tubes. 99.00

NET 106.50

MODEL DB20C—Amplifier in gold-finished metal enclosure 106.50

Pilot High Fidelity PILOTONE Amplifiers

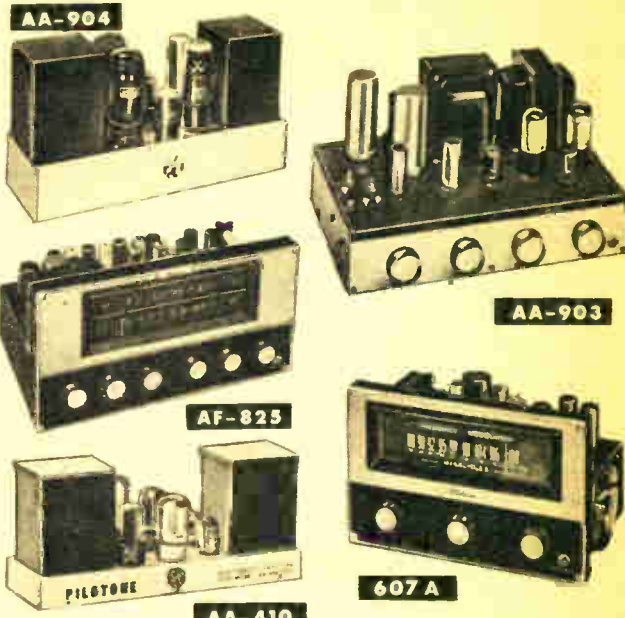

AMPLIFIER—MODEL AA-903

Williamson type 10 watt Amplifier, with built-in Pre-amplifier. Contains 7 tubes including Rectifier and push-pull output tubes. Controls are mounted behind decorative front panel which may be easily removed for cabinet installation, and includes, On-Off Volume, separate Bass and Treble Controls and Equalizer selector switch for LP, NAB, AES and Foreign Recording. Frequency Response ± 1 db 15 to 40,000 cycles. Distortion less than 1%. Hum level 70 db below 1 volt. Three inputs are provided for Radio and Auxiliary equipment and one input is provided with adjustable impedance for matching the various magnetic cartridges.

Amplifier Model AA-903 **NET 69.50**

MODEL AA-410 — 15 WATT HIGH FIDELITY PILOTONE AMPLIFIER

A basic Williamson-type High Fidelity Amplifier. Ideal for remote control from Pilotone preamplifiers or Pilotone. SPECIFICATIONS—POWER OUTPUT—15 Watts maximum. FREQUENCY RESPONSE—Plus/minus 1 db 15 cps to 40,000 cps at rated output. 115 Watts TOTAL HARMONIC DISTORTION—Less than 1% at 15 Watts from 30 cps to 15,000 cps. Less than 0.1% at 5 Watts from 30 cps to 15,000 cps. INTERMODULATION DISTORTION—Less than 2% at rated output. HUM AND NOISE LEVEL—90 db below rated output. OUTPUT IMPEDANCES—4, 8 and 16 Ohms. TUBE COMPLEMENT—one each 6CA, 12AU7, two 6AK1 and 5V3GT rectifier. UL Approved. Chassis finished in brushed gold. Size: 12 1/2" x 14" W x 6 1/2" High. Shpg. Wt. 16 lbs.

MODEL AA-410 NET 54.50

AF-825 PILOTUNER

The precision engineering—the sensitivity, selectivity and stability—of this superb Pilotuner are up to the high level that has won world-wide fame for Pilot as The Standard of Excellence. SPECIFICATIONS—Frequency Range: FM-88 to 108 MC, AM-540 to 1700 KC. Sensitivity: FM—3 Microvolts for 20 db quieting, AM—5 Microvolts for 2 volt output. Selectivity: FM—6 db down at 200 KC, AM—6 db down at 9 KC. Peak to peak separation for 120 KC—Linear for 190 KC. Antenna Input: FM—300 ohms to match external dipole, or built-in line cord antenna. AM—Internal ceramic powdered iron loopstick with provision for matching to standard RMA external antenna. Tone Control Range: (20 cps, 100 cps, 800 cps, 10,000 cps, 20,000 cps). Boost (19 db, 12 db, 0 db, 14 db, 19 db.). Cut (19 db, 12 db, 0 db, 14 db, 19 db.). Audio Output Im-

PILOT FM TUNER MODEL 607A

The new Pilot FM Tuner Model 607A is designed to give a very high standard of FM performance despite its low-cost. Incorporates automatic frequency control for simple "lock-in" tuning and drift-free reception. Tuned RF amplifier. AFC can be switched off. Has cathode-follower with 500 ohm output impedance. Response ± 0.5 db from 20-20,000 cycles. Sensitivity: 5 microvolts for 20 db quieting input for crystal Phono. Has built-in antenna. Tubes: 2-5BA6, 6U8, 6AU6, 6AU5, 12AU7, 6AB4, 6X4. Size 7 1/2" x 10 1/2" x 7 1/4". For 110-120 volts, 60 cycle AC. Shpg. Wt. 10 lbs.

MODEL 607A—List 99.25. .Net 69.50

MODEL AA-904 AMPLIFIER

The dependable world famous Williamson circuit now in a new, convenient, compact size. A worthy companion to the famous, dependable Pilotone. SPECIFICATIONS—FREQUENCY RESPONSE— ± 1 db, 15 cps to 50,000 cps at 15 Watts. ± 1 db, 20 to 20,000 cps at 1 Watt. TOTAL HARMONIC DISTORTION—Less than 0.1% at 10 watts output from 30 cps to 15,000 cps. Less than 0.5% at 25 watts output from 30 cps to 15,000 cps. INTERMODULATION DISTORTION—Less than 0.5% at 10 watts. HUM AND NOISE LEVEL: 90 db below 10 watts. OUTPUT IMPEDANCES: 4 and 16 Ohms. TUBE COMPLEMENT: Two 6AK1 6SN7GT and KT-66. One 5U4G rectifier. SIZE: 14" Wide x 4 3/4" Deep x 7 1/4" High. UL Approved. Shpg. Wt. 25 lbs.

MODEL AA-904 NET 99.50

AF-825—Pilotuner. Net 129.50

pedance: 500 ohms cathode follower. Input Impedance: Tape, AUX: 470,000 ohms. Phono with Preamp: 6500 ohms to 100,000 ohms variable with calibrated pot. Audio Sensitivity: For 1 volt output, Full Armstrong Dual Cascade Limiter—Discriminator circuit on FM. FM Features: Built-in power line antenna. Tuned RF Amplifier stage for improved sensitivity and selectivity. 3 gang tuning condenser. Automatic frequency control (AFC) for ease in tuning. On position on selector switch provides for disabling the AFC to allow tuning to a weak station adjacent to a strong station. Temperature compensated oscillator for minimum drift. Fully shielded against oscillator radiation to conform with FCC radiation specifications. Shpg. Wt. 16 lbs.

LAFAYETTE HIGH-FIDELITY LEADERS!

You cannot Beat these Prices!

**A CUSTOM PHONO-SYSTEM
AT TREMENDOUS SAVINGS — WITH NEW
GARRARD RC121 3-SPEED CHANGER AND
GE RPX-052A DIAMOND-SAPPHIRE CARTRIDGE**

Price Reg. \$143.36 SALE! 99.50

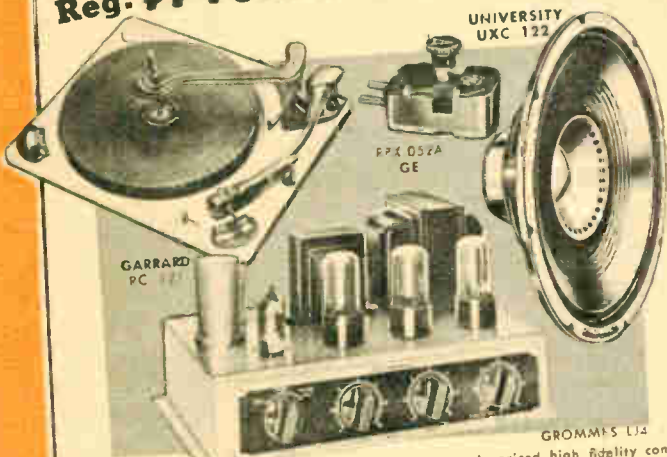

An unusually fortunate combination of very moderately priced high fidelity components providing excellent audio reproduction and smooth dependable performance. This system consists of the GROMMES LJ4 10-watt hi-fi amplifier employing features found only in the most expensive amplifiers, the world-famous GARRARD RC 121 mixer-changer equipped with the GE triple-play variable reluctance RPX-052A diamond-sapphire styli and new University UXC 122 12" high fidelity coaxial speaker. This low-cost phono system featuring famous name hi-fi components provides real enjoyment of fine phonograph records and at a saving of \$38.50 over the total cost of the individual components! Avail yourself of this remarkable offer and enjoy true hi-fi at the lowest possible price. Complete with all plugs and cables. For 110-120V 60 cycle AC. Shpg. Wt., 36 lbs.

HF-137 Complete System Net \$ 99.50
SYSTEM WITH FAIRCHILD CARTRIDGE AND DIAMOND LP STYLUS
 Same system as above with newest Fairchild Model 225 cartridge with diamond LP stylus instead of GE RPX-052A. Net \$114.50
HF-138—Complete System

**COMPLETE LAFAYETTE
FM-AM CUSTOM MUSIC SYSTEM
WITH NEW GARRARD RC121 CHANGER AND GE
RPX-052A DIAMOND AND SAPPHIRE CARTRIDGE**

Reg. Price \$233.10 SALE! 199.50

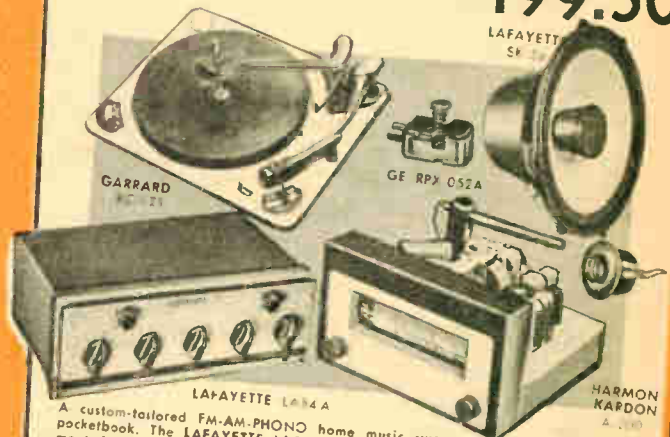

A custom-tailored FM-AM-PHONO home music system to suit your desires and pocketbook. The LAFAYETTE LA54 amplifier incorporates every significant refinement developed by audio engineers. Superb FM-AM listening pleasure in all types of signal areas is provided by the extremely popular HARMON KARDON Model A-200 FM-AM tuner. The new GARRARD RC-121 Renewal 3-speed Auto-Manual-Mixer record changer makes for reliability, high performance and operating simplicity. The changer comes equipped with the new GE RPX-052A triple play type SK-58 12" hi-fi coaxial speaker is a worthy companion to the other distinguished audio equipment comprising this ultra-compact custom music system. Complete with all plugs and cables, ready for instant installation. For 110-125 volts 60 cycle AC.

HF-121 Complete System Net \$199.50
HF-122 Same System as above with FAIRCHILD cartridge and diamond LP stylus instead of GE RPX-052A Net \$214.50

CUSTOM PHONO SYSTEM ONLY
Price Reg. \$154.00 Sale \$120.50
 An excellent custom phono system is available for those not wishing the FM-AM tuner in system HF-121 above.
HF-125 Same as HF-121 less A-200 FM-AM tuner. Shpg. wt. 38 lbs. Net 120.50

**CUSTOM FM-AM SYSTEM WITH NEW BOGEN
R-620 TUNER, GARRARD RC-121 3 SPEED
CHANGER, LAFAYETTE LA54 AND GE RPX-
052A DIAMOND-SAPPHIRE CARTRIDGE**

Reg. Price \$263.90 SALE! 219.25

A system which provides you with the finest in home music enjoyment and an undreamed of realism and faithfulness in the reproduction of broadcast or recorded music impossible to obtain from a conventional radio or phonograph. The new BOGEN R-620 FM-AM tuner assures excellent sensitivity and high selectivity. A remarkably effective Automatic Frequency Control determines easy, precise tuning through the full FM and AM frequency bands. The record playing and changing requirements of this system are handled by the new latest model GARRARD RC-121 3 speed intermix changer equipped with the GE RPX-052A triple play turnover reluctance cartridge with diamond LP and sapphire 78 rpm styli. The loudspeaker requirements for this system are exceptionally well handled by the University UXC 123 12" hi-fi triaxial speaker with built-in brilliance control and beautiful tone quality. The LAFAYETTE LA54 amplifier incorporates every significant refinement developed by audio engineers. Complete with prepared cables for simple assembly of the system. For 110-120V 60 cycle AC. Shpg. wt., 49 lbs.

HF-139—Complete System Net \$219.25
SYSTEM WITH FAIRCHILD CARTRIDGE AND DIAMOND LP STYLUS
 Same system as above with newest Fairchild Model 225 cartridge with diamond LP stylus instead of GE RPX-052A.
HF-140—Complete System Net \$234.25

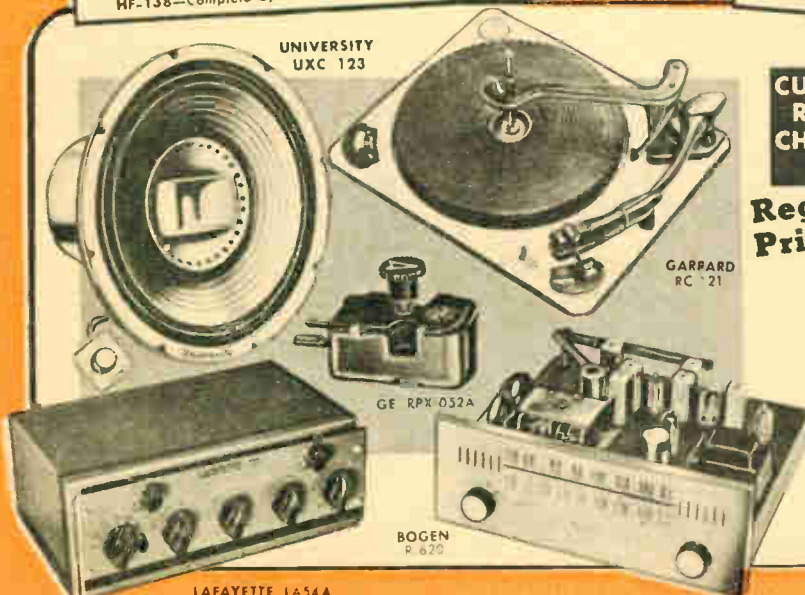

LAFAYETTE LA54A

LOOK AT THESE PRICES

At first no one could believe it!

HI-FI MULTI SPEAKER SYSTEMS



**8" PM-6.8 oz. Woofer
5" PM Tweeter**

Crossover Network 20-15,000 cycles



G.E. 8" 'Woofer' 5" Tweeter

Network



UNFINISHED CABINET

Now, for the first time, an enclosure that will give you real High Fidelity performance in a small package—with the advantage of the 2-way speaker principle. Positively will outperform any speaker arrangement costing twice as much. Comprises a special G.E. 8" PM 12-watt speaker with 6.8 oz. magnet acting as a "woofer" plus a 5" specially designed PM Tweeter and Crossover Network to increase the high frequency range up to 15,000 cycles. Clear, smooth reproduction, with the unmistakable "presence" of the 2-way hi-fi reproducer—will recreate a tone balance which is unbelievable.

UNFINISHED CABINET

Cabinet is unfinished—handsomely styled—made of finest birch, perfect for the Blond or Mahogany finish you want, or you can paint it to match the style and finish that blends in with the rest of your furniture. Reproducer is completely enclosed. Size: 23½" L x 11¼" W x 10½" D. Shpg. Wt. 22 lbs.

- No. SY-10—Complete 2-way Speaker System And Crossover Network installed in unfinished cabinet **Net 29.45**
- No. SY-11—Complete System (Less cabinet) **Net 13.75**
- No. SB-34—Cabinet only **Net 19.50**



**5" Tweeter
AND
Crossover
Network**

Tweeter Network

A specially designed 5" Tweeter and Crossover Network that will assure high frequency response when used with any speaker you now possess. You can now make your present speaker into a 2-way speaker system increasing the high frequency range up to 15,000 cycles. Diagram included. Shpg. Wt. 5 lbs.

- STOCK NO. SY-14 **Net 7.95**
- Stock No. MS-71 Crossover Network only **Net 5.95**
- Stock No. SK-35 5" Tweeter only **Net 2.45**



**12" PM-9 oz. Woofer
5" PM Tweeter**

Crossover Network 20-15,000 cycles

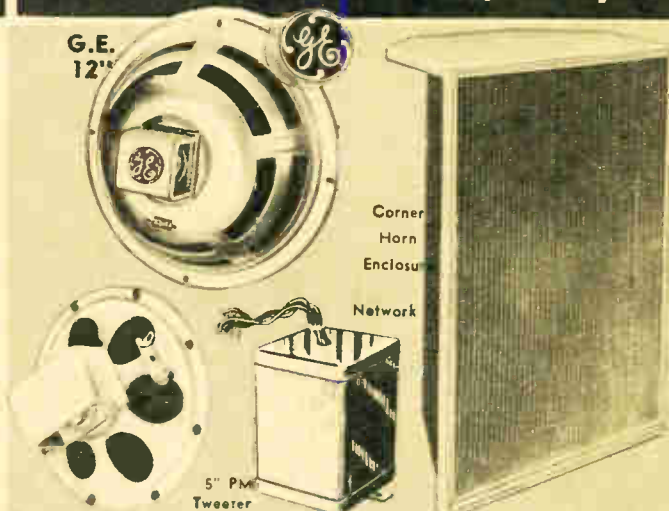

G.E. 12"

Corner Horn Enclosure

Network

5" PM Tweeter

CORNER HORN ENCLOSURE (Unfinished)

2-Way Speaker System

Now you can enjoy the finest and yet pay no more. A full 2-way speaker system for the audio enthusiasts. Especially designed corner horn enclosure makes possible extended bass response and eliminates cabinet resonance. Excellent performance is achieved in direct radiation of high frequencies. The 2-way speaker system consists of the Famous G.E. 12" PM heavy duty 25 watt speaker with 9 oz. magnet acting as a "woofer", a specially designed 5" PM Tweeter with Crossover Network to increase the high frequency range to 15,000 cycles; in an unfinished Corner Horn Enclosure, which you can finish to match the style and finish that blends in with the rest of your furniture. Reproducer is completely enclosed. All units are mounted, ready for use. Size: 21" W x 31½" H x 13½" D. Shpg. Wt. 48 lbs., Enclosure only 35 lbs.

- Model SY-13 **Net 57.95**
- Model SB-35 Unfinished Corner Horn Enclosure **Net 44.95**

12" UNFINISHED SPEAKER BAFFLES

Unfinished reflex baffles for Hi-Fi speakers. Careful acoustic design assures excellent performance. Constructed of selected veneer. Front panel behind grille cut for 12" speaker and 5" Tweeter with acoustic port. Supplied with block of wood to cover 5" tweeter hole if tweeter is not used. Front is covered with attractive plastic grille. All sanded and ready for finishing. Dimensions 23½" x 33½" x 12½". Shpg. Wt. 30 lbs.

- Model SB-36 **Net 29.95**
- UNFINISHED 12" SPEAKER BAFFLE WITH TWO-WAY SPEAKER SYSTEM

The 2-way speaker system described below (SY-12) completely installed in this unfinished baffle **Model SY-15 Net 43.90**



2-WAY SPEAKER SYSTEM

- G.E. 12" PM—25 Watt—9 oz. magnet 'Woofer'
- 5" Tweeter and Crossover Network

Ideal for custom installations, where a 2-way speaker system is desired to obtain a high degree of audio fidelity at a price that will fit your pocketbook. You can now replace your old speaker in your present phonograph with a 2-way speaker system that will give you clean, distinct bass response provided by the Famous G.E., heavy duty 12" PM 'woofer' with exceptionally large Alnico V magnet (9 oz.), and increase the high frequency range with the 5" Tweeter and Crossover Network, making this assembly a complete 2-way music system which will recreate a tone balance that will astonish you. Will outperform any speaker arrangement costing 2 or 3 times Lafayette's Price. Wiring Diagram included. Shpg. Wt. 13 lbs.

- STOCK NO. SY-12 **Net 15.75**

only **LAFAYETTE** can do it!

**OUR DIRECT IMPORTATIONS
YOU SAVE IMPORTERS PROFIT!**



New Professional TRANSCRIPTION TURNTABLE
THE FINEST TRANSCRIPTION TURNTABLE FOR BOTH
THE PROFESSIONAL USER AND THE AUDIOPHILE



- 12" CAST ALUMINUM RIM DRIVEN TURNTABLE • HEAVY DUTY 4-POLE CONSTANT SPEED MOTOR • VARIABLE SPEED CONTROL, PERMITS CONTINUOUSLY VARIABLE ADJUSTMENT OF EACH SPEED WITHIN $\pm 7\%$ • SPEED SELECTOR SAFETY SWITCH • FREELY FLOATING MOTOR MOUNT • AUTOMATIC IDLER WHEEL DISENGAGEMENT WHEN OFF.

New 3-speed instrument to delight the connoisseur. The heavy 12" non-magnetic lath-turned aluminum turntable is precision engineered to provide dynamic balance and "wow-free" operation and has an extra-heavy rim for smooth effective flywheel action. The turntable, mounted within a deep flanged well, is rim-driven and actuated by perfectly true pulleys and an oversized rubber idler wheel. The precision ground and polished nickel-chrome steel main spindle is ball-bearing mounted to assure noiseless, rumble-free rotation of the turntable. The extra-sized lubricant housing in which it is seated insures proper lubrication of the spindle at all times. A heavy rubber record cushion affords maximum record traction, eliminates slippage and makes for greater record protection.

A high torque, heavy-duty, constant speed 4-pole induction motor rotates the turntable at 33-1/3, 45 and 78 rpm. There is virtually no magnetic leakage and there is no hum pickup even with the sensitive variable reluctance cartridges. A dynamically balanced armature insures minimum wow and flutter content and accurate speed regulation. A variable speed control featuring an exclusive adjustable 3-point brake action permits instant adjustment of the individual speeds within $\pm 7\%$ and compensates for variations in source voltage which are encountered. With power off, the idler wheel is automatically disengaged to keep the idler perfectly round and true, preventing rumble. A speed selector safety switch protects idlers and other mechanism by making it obligatory to pass through an OFF position when switching from one speed to another. The motor is freely suspended and isolated by means of three unique shock mountings which eliminate vibration transfer. For 110-130V 60 cycle AC with each unit also equipped with a pulley for 50 cycles. Power consumption is 12 watts. Wow is less than .2%, flutter less than 0.05% and there is practically no rumble. Size: 13 1/2" deep, 14" wide, and requires clearance of 2 3/4" above motorboard (excluding pick up arm) and 3 3/4" below motorboard. Supplied with removable 3-speed stroboscopic disc for 30 and 60 cycles, removable 45 rpm adapter and tone arm adapter. Handsome hammertone gray finish. Shpg. wt. 20 lbs.

PK-100

Net 49.50

Reg. Value
74.50
Net
49.50

COMBINATION DEAL

PK-100 TURNTABLE AND
PK-90 TONE ARM with
G.E. RPX-052A DIAMOND
and SAPPHIRE Cartridge

72.50

TURNTABLE TONEARM
AND NEW FAIRCHILD
MODEL 225
"MICRADJUST" DIAMOND
LP CARTRIDGE

87.50

**VISCOUS-DAMPED TRANSCRIPTION
TONE ARM**

PROFESSIONAL QUALITY TRANSCRIPTION PICKUP ARM
FOR THE MOST EXACTING HIGH FIDELITY INSTALLATIONS



- JEWEL BEARING SUPPORT • PERFECT RECORD TRACKING • AUTOMATIC FLUID CONTROL OF TONE ARM MOVEMENT • ACCEPTS RECORDS UP TO 16 INCH DIAMETER • SOLDERLESS INSTANT PLUG-IN CARTRIDGE CHANGE • ACCOMMODATES VIRTUALLY ALL STANDARD AMERICAN CARTRIDGES • PREVENTS TONE ARM DAMAGE TO RECORDS

This new Viscous-Damped tone arm represents the ultimate in advance transcription arm design and engineering, utilizing the principle of "viscous-damping" or fluid control to regulate both the horizontal and vertical movement of the tone arm. Perfect compliance is achieved at all three speeds for both old and new records at most stylus pressure, consequently eliminating tone arm resonance. The balance provided by this suspension principle virtually eliminates groove jumping and skipping.

The slide-in cartridge holder allows instantaneous mounting of all standard types, including the turnover G.E. cartridge, with correct stylus pressure automatically obtained. Spring clips maintain positive electrical contact without necessity of soldering. The amount of damping and pressure is controlled by a manual viscosity adjustment mounted on top of the arm. A finger rest positions the tone arm. Records are protected against damage even when the tone arm is accidentally dropped. The arm is 12 inches long with its height fully adjustable by means of a telescoping shaft. Self-leveling screw adjustments are built into the tone arm base. A pick-up rest whose height is adjustable, accompanies the tone arm.

This tone arm is a professional quality companion to the PK100, with matching finish. Shpg. wt. 2 1/2 lbs.

PK-90

Net 19.50

Reg. Value
39.95
Net
19.50

SPECIAL!

WITH FAIRCHILD
MODEL 225
"MICRADJUST"
DIAMOND LP
CARTRIDGE
49.50

NEW!

LAFAYETTE
EXCLUSIVE

12" HIGH FIDELITY COAXIAL SPEAKER



Reg. Value
44.50
Net
29.50

- FREQUENCY RANGE 30-15000 CPS • HANDLES 20 WATTS OF POWER • COMPLETE WITH LEVEL CONTROL • POWERFUL TSK-5 MAGNETS • SPECIAL SHEEP-SKIN-EDGED CONE.

This Lafayette exclusive impart is a highly efficient 12" coaxial speaker and represents an exceptional high fidelity value. The low frequency woofer has a 12" special chemically processed fibre composition cone with logarithmically placed pleats. The low resonant cone achieves a flaring edge by means of a free edge of sheepskin which suppresses unwanted circular and radial nodal vibrations and insures clear beautiful tone quality. A 2 1/2" tweeter is coaxially mounted within its own metal case and protective grille with front mounted diffuser. The construction is such that there is no back radiation whatsoever. A crossover network to provide proper separation of high and low frequencies, and having a crossover point of 3000 cps, is also built-in. Highly efficient TSK-5 magnets permit a compact system, delivering full-bodied brilliant tone. A high frequency level control provides variation of up to 6 db cut. Power handling capacity is 20 watts continuous and 35 watts peak. Voice coil impedance 8 ohms, resonant frequency 40 cps. Connections are made to screw cap terminals. Rugged all-metal frame. If made in this country this speaker would sell for at least \$49.50. Shpg. wt. 11 lbs.

SK-58

Net 29.50

Lafayette Radio

NEW YORK 13, N. Y., 100 Sixth Ave., REctor 2-8600

NEWARK 2, N. J., 24 Central A

BRONX 58, N. Y., 542 E. Fordham Rd., FOrdham 7-8813

PLAINFIELD, N. J., 139 W. 2nd

BOSTON 10, MASS., 110 Federal St., HUbbard 2-7850

HOW TO ORDER

Use our convenient order blank (additional blanks sent on request). Please write in ink, legibly, and not more than ONE item to a line. Make sure you write the exact stock number and that the price is the one quoted for the item you want. Specify how we shall make shipment by checking the preferred square "Parcel Post", "Express" etc. We shall follow your instructions, but will change them wherever we are sure that such a change is to your better interest. Please keep all correspondence or remarks relative to your order on a separate sheet of paper. Make sure you include sufficient postage; all overpayments promptly refunded (if overpayment is under 10c, we will credit your account).

NOTE: In many instances, especially in the tabulated lists of merchandise, it is impossible to show shipping weights. In practically all cases, it is a simple matter to estimate the weight of each article. Please be sure to include sufficient postage. We will credit you with any overpayments.

DOMESTIC ORDERS

We buy for cash and sell for cash; this explains our low price policy. We do not carry credit accounts, and we pass on to our customers all savings effected by the elimination of costly bookkeeping. We will ship C.O.D. if desired, providing a deposit of at least 25% accompanies your order. C.O.D. parcels may be shipped ONLY to places in the 48 states of the U. S. and to U. S. territories. Remittance in full saves you extra collection costs.

ORDERS OUTSIDE OF THE CONTINENTAL UNITED STATES

All orders outside of the continental United States are handled at our main office in New York, and should be marked to the attention of our Export Department. All prices on such orders are net, F.O.B. our New York City warehouse, subject to change without notice. The merchandise is payable by either confirmed, irrevocable letter of credit, or by a remittance in United States dollars at a New York bank, and should include enough to cover shipping, insurance, and consular expenses. All orders should have a minimum merchandise value of \$40.00. Goods are packed in cardboard cartons; for wooden export packing there is a slight additional charge. Please send all correspondence by air for faster service.

DO NOT RETURN ANY MERCHANDISE BEFORE OBTAINING OUR AUTHORIZATION.

FINAL PRICES

Prices shown in this catalog are net, and except where marked POSTPAID, do not include postage. All discounts have been deducted, including 2% discounts for cash. Prices are subject to change without notice; we give customers the benefit of all reductions taking place after the catalog is published. Orders are filled at prices in effect at time of shipment.

POSTPAID ITEMS

Items marked "Shipped Postpaid" do not require postage. Please note that Postpaid items refer only to shipments made within the 48 states of the U. S. (U. S. possessions not included.)

SENDING MONEY

The safest and best way to send money is by: American Express; Post Office or Telegraph Money Order; bank drafts; firm checks; stamps. Do not send cash. If absolutely necessary to remit cash, send by registered mail only. Do not hesitate to include sufficient postage; over-payments are promptly refunded.

RETURNING MERCHANDISE

This order blank will be returned to you upon shipment of your order. If you find it necessary to return any merchandise for adjustment, please write returning the order blank and any attached papers, stating the following: reason for return, when and where purchased, number and date of sales slip if purchased at salesroom. If your shipment is received damaged, obtain a report from the postmaster or express agent and mail it to us. Use a separate sheet of paper for all adjustment matter; do not add remarks to a new order for parts. Do not include money in the package you return. When returning merchandise, pack carefully, insure, and write your name and address on all packages and letters before returning to us.

NOTE: Equipment built or ordered especially to meet customers requirements not subject to exchange, credit or refund. All orders for special merchandise must be accompanied by a deposit.

PARCEL POST RATES FOR ALL SUBJECT TO POST OFFICE RATES

Parcels up to 8 ounces may be shipped anywhere in the United States for 8c. Parcel Post shipments over 8 ounces, mailed at a first class post office, addressed for delivery at another first class post office, shall be limited in size and weight as follows:— 72 inches in length and girth combined, 40 lbs. to 1st and 2nd zone to 8th zone, 10 in. width length and twice 10 equals 60

WEIGHT IN LBS.	LOCAL	ZONE				
		1-2 UPTO 150 MILES	3 150 TO 300 MILES	4 300 TO 600 MILES	5 600 TO 1000 MILES	6 1000 TO 1500 MILES
1	\$0.18	\$0.23	\$0.23	\$0.24	\$0.25	\$0.26
2	.20	.27	.29	.31	.32	.33
3	.21	.31	.34	.38	.40	.41
4	.23	.35	.39	.45	.48	.50
5	.24	.39	.44	.52	.56	.58
6	.26	.43	.49	.59	.64	.67
7	.27	.47	.54	.66	.72	.75
8	.29	.51	.60	.73	.80	.84
9	.30	.55	.65	.80	.88	.92
10	.32	.59	.70	.87	.96	1.00
11	.33	.63	.75	.93	1.03	1.07
12	.34	.67	.80	1.00	1.11	1.15
13	.36	.71	.85	1.07	1.19	1.24
14	.37	.75	.90	1.14	1.27	1.32
15	.39	.79	.96	1.21	1.35	1.40
16	.40	.83	1.01	1.28	1.43	1.48
17	.42	.87	1.06	1.35	1.51	1.56
18	.43	.91	1.11	1.42	1.59	1.64
19	.45	.95	1.16	1.49	1.67	1.72
20	.46	.99	1.21	1.56	1.75	1.80
FOR EACH ADDED LB.						
ADD	2c	4c	5c	7c	9c	10c

APPROXIMATE EXPRESS CHARGES (SUBJECT TO RATE CHANGES)

Express charges are also determined by the weight of the shipment from the shipper. The following chart indicates approximate charges.

WEIGHT	100 MILES	150 MILES	300 MILES	500 MILES	750 MILES	1000 MILES
20 Lbs.	2.00	2.17	2.35	2.75	2.92	3.10
30 "	2.26	2.52	2.78	3.42	3.64	3.86
40 "	2.51	2.86	3.21	4.06	4.35	4.64
50 "	2.77	3.21	3.64	4.71	5.07	5.43
60 "	3.03	3.55	4.08	5.35	5.79	6.21
70 "	3.29	3.90	4.51	6.00	6.51	7.00
80 "	3.55	4.24	4.94	6.64	7.22	7.77
90 "	3.80	4.59	5.37	7.29	7.94	8.55
100 "	4.06	4.93	5.80	7.93	8.66	9.34

CATHODE RAY and TRANSMITTER Type Tubes To

INSURANCE

Parcel Post Insurance Rates

5c	for parcels valued up to	\$5.00
10c	" " " " " " " " " "	\$10.00
15c	" " " " " " " " " "	\$25.00
20c	" " " " " " " " " "	\$50.00
30c	" " " " " " " " " "	\$100.00
35c	" " " " " " " " " "	\$200.00

Express Insurance Rates

For shipments under \$50.00, no extra insurance charge.
For shipments valued from \$50.00 to \$150.00, 18 cents
For each additional \$100.00 value or part thereof beyond \$150.00, add 18 cents.

EXPRESS & FREIGHT SHIPMENTS

Express and freight shipments are sent transportation charges collect. If your station has no agent, please send sufficient money to cover transportation. Charges are the same either way. All over-payments are promptly refunded.

Transportation slightly higher charges in costs outlining insurance.

When the value is \$0.01 to \$0.10 to \$10.01 to \$25.01 to \$50.01 to \$100.01 to \$150.01 to

The Post Office money order these fees

Orders from New York sales tax and postage



YOU BE THE JUDGE!

Custom High Fidelity Phono System Of Superior Quality

If this system does not give you utmost satisfaction and represent a tremendous saving, you may return it for a cash refund! Need we say more?!!!



SALE
154⁵⁰

ONLY LAFAYETTE CAN MAKE THIS OUTSTANDING OFFER BACKED BY A MONEY-BACK GUARANTEE!

- FINEST 3-SPEED TRANSCRIPTION TURNTABLE WITH VARIABLE SPEED CONTROL
- PROFESSIONAL QUALITY VISCOUS-DAMPED TRANSCRIPTION TONE ARM
- LATEST FAIRCHILD CARTRIDGE MODEL 225 WITH DIAMOND LP STYLUS
- COMPLETE, DELUXE PRINTED CIRCUIT AUDIO AMPLIFIER
- 12" HIGH FIDELITY COAXIAL SPEAKER

A phono-system with the finest professional quality TRANSCRIPTION TURNTABLE and VISCOUS-DAMPED PICKUP arm and equipped with the newest FAIRCHILD DIAMOND LP CARTRIDGE. The LAFAYETTE MODEL LA54 AMPLIFIER has many advanced technical features as does the SK58 SPEAKER which is capable of superb response. It is no wonder that we urge you to judge both the fine quality and outstanding value contained in this Lafayette offer. Once you hear its excellent audio fidelity and observe its dependable performance, you too will become enthused by this unusually popular combination of moderately priced, professional type hi-fi components. Com-

plete system with interconnecting plugs and cables and ready for instant installation.
For 110-120V, 60 cycles AC. Shpg. wt. 46 lbs. MF-126 **Net 169.50**
System with GE RPX-052A Diamond-Sapphire Cartridge.
Same system as above with the GE RPX-052A Triple-Play Cartridge with DIAMOND LP and SAPPHIRE standard styli. MF-127 **Net 154.50**

New
FLOATING ACTION!

LAFAYETTE HIGH FIDELITY TRANSCRIPTION TURNTABLE AND TONE ARM COMBINATION



FINEST TRANSCRIPTION TURNTABLE MODEL PK-100 AND VISCOUS-DAMPED TONE ARM MODEL PK-90 ON BEAUTIFULLY FINISHED WOOD BASE

77⁴⁵

- | | | |
|---------------------------------------|---|------------------------|
| Woodbase only . . . Shpg. wt. 13 lbs. | } | 19⁵⁰ |
| PK-95 . . . Red Mahogany | | |
| PK-96 . . . Brown Mahogany | | |
| PK-97 . . . Blonde | | |
| PK-98 . . . Ash (Illustrated above) | | |
| PK-99 . . . Ebony | | |

Professional 3 speed turntable with variable speed control and fluid-controlled tone arm plays all records up through 16" transcription discs. The heavy duty, high torque 4-pole shaded induction motor is shock-mounted and freely suspended to eliminate vibration. Meets professional standards for wow, flutter content and speed regulation. The heavy die-cast aluminum turntable is rim-driven, dynamically balanced and ball bearing mounted to provide rumble-free rotation. The tone arm accommodates all standard type cartridges with instant, solderless, plug-in cartridge change. The viscous damping achieves perfect compliance yet prevents groove jumping and skipping as well as record and stylus damage should the tone arm be accidentally dropped.
The substantial woodbase is a deluxe unit which is made of the finest selected solid hardwood outside pieces and has mitered corners secured with clamp nails. The mounting board is free-floating on individual springs in each corner which can be individually leveled. The base has a genuine hand-rubbed finish and comes in five cabinetmaker shades, red mahogany, brown mahogany, blonde, ash and ebony. Specify your choice when ordering. The top of the motorboard has an attractive copper finish. Its elegant styling and finish adds beauty to any high fidelity installation. Size: 16" x 20" x 5".
Complete unit ready to install, requiring easy mounting of turntable and tone arm on pre-cut mounting board. For operation from 110-130V 50/60 cycles AC. Shpg. wt. 36 lbs. MF-128 (less cartridge) **Net 77.45**

NEW! GARRARD AUTO-MANUAL RECORD CHANGER

With New And Latest Model FAIRCHILD DIAMOND LONG-PLAY CARTRIDGE

ONLY LAFAYETTE BRINGS YOU THESE SPECTACULAR SAVINGS ON THE LATEST MODEL GARRARD RECORD CHANGERS AND FAIRCHILD DIAMOND CARTRIDGE (REG. \$37.50)



COMPLETE WITH FAIRCHILD DIAMOND LP CARTRIDGE
\$81.16 NET

RC88 TRIUMPH II



COMPLETE WITH FAIRCHILD DIAMOND LP CARTRIDGE
\$69.40 NET

RC121 REKNOWN



COMPLETE WITH FAIRCHILD DIAMOND LP CARTRIDGE
\$93.90 NET

RC 98 CROWN II

3-Speed deluxe Auto-Manual changer, successor to the RC10 Triumph. Full manual position with finger-tip control gives this automatic changer the versatility of a single-play turntable. Smooth, quiet shaded 4-pole "Induction-Surge" motor, silent free-wheeling ballbearing turntable mount and oversized live rubber idler traction wheel. Features a true-turret drive with all 3 speeds operating off the motor on a single turret which eliminates drive belts. Shielded condenser-resistor network and reinforced automatic muting switch. Heavy steel precision turntable covered with rubber tractor mat. Simplified stylus pressure and pickup height adjustments. Watch-like construction with sensitive trip mechanism, automatic stop and shutoff brake. Foolproof, gentle record pusher platform. Floating motor completely isolated and damped. Size 15 1/2" x 13 3/4" with 5 1/4" clearance above and 3 3/4" clearance below mounting board. Complete with line cord, pickup lead, plug-in shells, mounting hardware, standard and manual spindles, 45 rpm adaptor. Less cartridge and less automatic 45 rpm spindle. Shpg. wt. 16 lbs.
Model RC88 Net 53.41
Model RC88 / GE With GE RPX-050A Cartridge (Sapphire LP and 78 rpm styli) Net 60.02
Model RC88 / GE With GE RPX-052A Cartridge (Diamond LP and sapphire 78 rpm styli) Net 71.05
Model 4558 45 rpm automatic spindle for use with RC88 Net 3.43

A deluxe straight spindle type record changer compact enough for replacement use, yet superior to other fixed spindle types. Features "Simpli-Mix" operation whereby 12", 10", or 7" records may be stacked together, bottom to top in this order, loaded on the fixed spindle at one time and the overarm placed in position. Automatic operation results with the tone arm dropping into correct position regardless of record size. 45 RPM records are placed using clip-in adapters or with optional automatic spindle available below. Fully automatic and manual operation. "Induction-Surge" motor true-turret drive, ballbearing turntable mount, tone arm, stylus-pressure adjustments, trip mechanism, automatic stop and practically all of the features found in the new Garrard changers are likewise incorporated in this model. Size 14 1/2" x 13" requiring 4 3/4" clearance above and 3 3/4" below motorboard. 100-130/200-260 volta, 60 cycle AC operation. Complete with line cord, pickup cable, plug-in shell, mounting hardware. Less cartridge and less 45 RPM automatic spindle. Shpg. wt. 14 lbs.
Model RC121 Net 41.65
Model RC121 / GE With GE RPX-050A Cartridge (Sapphire LP and 78 RPM styli) Net 48.26
Model RC121 / GE With GE RPX-052A Cartridge (Diamond LP and sapphire 78 RPM styli) Net 59.29
Model 4552 45 RPM Automatic spindle for use with RC-121 Net 3.43

The RC 98 CROWN II 3-speed Super Auto-Manual record changer combines all of the advancements of the RC10 which it succeeds, and of the new RC88, including Garrard's new automatic and full manual performance. In addition, it contains several new high-fidelity innovations which are characteristic of the model. A feature is its exclusive all-speed variable control which makes possible a continuously variable + or - wide range adjustment of each speed. This is important to those with "perfect pitch" since it permits the RC98 to be "tuned" to the pitch or key of a musical instrument. This variable speed control is obtained by means of an all electrical rheostat operation varying the voltage in the motor coils with no friction or efficiency losses. A special 45 RPM automatic spindle is included in the RC98 standard spindle equipment. Cabinet dimensions are the same as the RC88. Complete with line cord, pickup lead, plug-in shells, mounting hardware, spindles including automatic 45 RPM spindle, less cartridge. Shpg. wt. 17 lbs.
Model RC98 / GE With GE RPX-050A Cartridge (Sapphire LP and 78 RPM styli) Net 66.15
Model RC98 / GE With GE RPX-052A Cartridge (Diamond LP and Sapphire 78 rpm styli) Net 83.79

SALE!

Buy at Lafayette's LOW SALE PRICE

Webcor

3 SPEED AUTOMATIC RECORD CHANGER

You'll find this famous Webcor Diskchanger not only in Webcor Phonographs but in radio phonograph combinations of other famous manufacturers. This is truly supreme excellence in record changing. Not only does it play all 3 speeds and all sizes of records, but it plays up to four hours automatically... then shuts itself off after the last record has played. The Webcor Diskchanger was designed for swift, silent record changing; smooth, accurate turntable speeds; and gentle treatment of your precious records. To obtain these qualities, Webcor has included such outstanding features as the Balanced Tone Arm Electrostatically Flocked (super-soft) turntable. Shpg. Wt. 16 lbs. Singly, ea. **24.95**

• Brand new fully automatic 3 speed record changer
• Dual turn-over cartridge with dual styli
• Automatic shut-off after last record

24.95

WEECOR WITH G. E. CARTRIDGE
STOCK NO. PK-48 Same as above but with G. E. RPX-050A Triple-play cartridge List Price, \$51.75 **NET 27.95**

BOGEN 4-SPEED HIGH-FIDELITY TRANSCRIPTION TURNTABLE MODEL B50-16

New, manually operated model playing all discs up to 16" at all 4 standard speeds (78, 45, 33 1/3 and 16 RPM). Features single control, precision regulated continuous variable speed from 29 to 86 RPM. A weighted, balanced 11 3/4" turntable and heavy-duty 4-pole constant-velocity motor reduce wow to less than .5% and keep hum and rumble at similarly negligible levels. Adjustable stylus pressure minimizes record wear and "feather drop" action of arm eliminates possibility of stylus or record damage. Arm equipped with a plug-in head for ease in changing cartridge and stylus. Vibration isolators supplied with turntable. Size 15" x 12" requiring 2 3/4" clearance above and 2 1/2" below mounting board. Shpg. wt. 15 lbs.

FAMOUS V-M-TRI-O-MATIC RECORD CHANGERS

Play all records, 33 1/3, 45 and 78 Rpm in all sizes. Combination "feeler" arms and button automatically adjust the pickup for proper set-down, regardless of record size. Completely Jamproof - pickup can be held at any time without damaging mechanism. 10" and 12" records of same speed can be intermixed. Model 961 are less cable and plug; mounting space 13 1/2" W x 12" D; 5" above and 3" below plate for operation from 110-125 Volt, 60 cycle AC.
Model 951A: With turnover crystal cartridge and Dual Needle. Shpg. wt. 11 lbs. **30.22 NET**
Model 935B - MF CHANGER: Size 13 1/2" x 13 1/4" requires 5" clearance above mounting board and 3 1/2" clearance below. Less cartridge, AC cord and output cable. Shpg. wt. 12 1/2 lbs. LIST PRICE - **59.95 NET**
Model 935B, GE - MF CHANGER with G.E. RPX-050A TURNOVER CARTRIDGE. NET **43.90**
Model 936B MF CHANGER ON METAL BASE: As above but with gold finish metal base, 6 ft AC cord and 4 ft output cable. Size 13 1/2" x 13 1/4" x 8 1/2". Shpg. wt. 18 1/2 lbs. LIST **69.95 NET**

45 SPINDLE
V-M "45" SPINDLE. Permits playing 45 rpm records without using spindle spider. For above changers: also Models 960, 960GE, 955 and 955GE. Shpg. wt. 8 oz. List, **2.95 NET**
Model 936B GE (same as above) but with G.E. RPX-050A Turnover cartridge. **NET 49.90**

THE NEW VM MODEL 1200 4 SPEED CHANGERS!

Automatically plays 33 1/3, 45, and 78 rpm records plus the new popular talking book 16 2/3 rpm speed. Other features are: Easy-Lift record support arm, New, low-torque mechanism aluminum die cast tone arm, new patented drive motor etc. Size 12 3/4" dup. 13 3/4" wide, 8-5/16" high overall. Shpg. wt. 15 lbs.; for 110-120 volt 60 cycle AC operation.
Model 1200 WITH CRYSTAL TURNOVER CARTRIDGE: LIST PRICE - **46.50 NET 30.22**
Model 1200 G.E. WITH G.E. RPX-050A TURNOVER CARTRIDGE: LIST PRICE - **48.95 NET 33.47**
Model 1225 CHANGER ON METAL BASE, in matching colors, with Crystal Turnover cartridge size 12" x 13 3/4" x 8 1/2", shpg. wt. 20 lbs. LIST PRICE - **48.95 NET 32.66**
Model 1225 G.E. CHANGER ON METAL BASE, in matching colors, with G.E. RPX-050A turnover cartridge. LIST PRICE - **54.95 NET 35.91**

Model B50-16 (with wide range crystal cartridge and dual sapphire-tipped styli) **Net 42.00**
Model B50-16X with GE RPX-050A variable reluctance magnetic cartridge dual sapphire-tipped styli) **Net 48.65**
Model B50-16LC (with one plug-in head less cartridge) **Net 40.40**
Model PBS Attractive Woodbase 16" x 13" x 2" for convenient mounting of transcription player. Shpg. wt. 5 lbs. **Net 4.50**
Model B20 Similar 4-standard variable speed transcription player, for discs up to 12" in diameter, with crystal cartridge and dual sapphire-tipped styli. Shpg. wt. 9 lbs. **Net 61.55**
Model P80 Woodbase for mounting B20. Shpg. wt. 5 lbs. **Net 4.80**

New Collaro

MODEL RC 456 4 SPEED RECORD CHANGER



• COLLARO RC 456 WITH G. E. RFX-052-A DIAMOND-SAPPHIRE CARTRIDGE

41.95

• COLLARO RC 456 WITH FAIRCHILD MODEL 225 "MICRO-ADJUST" DIAMOND LP CARTRIDGE

60.95

Made In England

This new improved model of the world famous changer made in England provides high fidelity operation at all four speeds; 78, 45, 33-1/3 and 16-2/3 RPM. The new Collaro RC 456 offers full "manual" operation as well as automatic intermix of all size records. The other Collaro features found in its predecessor, the RC 54, are likewise found in the RC 456. **POWERFUL, QUIET 4-POLE MOTOR** — with integrally-built 4-speed drive mechanism and dynamically balanced rotor. **WEIGHTED, BALANCED TURNTABLE** — assures freedom from "wow". **AUTOMATIC IDLER DISENGAGEMENT** — prevents idler flat spots when switched to "off". **INSTANT SELECT AND AUTOMATIC SWITCH-OFF** — provides efficiency of operation. **AUTOMATIC SWITCH AND BUILT-IN R/C NETWORK** — for elimination of extraneous noises. **DIMENSIONS** — 12 x 13 1/2 inches with 5/8" clearance above and 2 1/4" clearance below mounting board required. **PRE-WIRED FOR EASY INSTALLATION.** Shpg. Wt. 20 lbs.

MODEL RC 456 WITH GE RFX-052A CARTRIDGE

NET 41.95

MODEL RC 456 WITH FAIRCHILD 225 DIAMOND LP CARTRIDGE

NET 60.95

MAHOGANY OR BLOND WOODBASE CUT TO FIT ABOVE

Specify finish. Shpg. wt., 5 lbs.

Net 3.95

MOUNTING BOARD CUT TO FIT ABOVE

Unfinished for easy staining. Shpg. wt., 3 lbs.

Net .95

ACCESSORIES

AUTOMATIC 45 RPM SPINDLE

GSA SPINDLE

NET 3.23

PLUG-IN AUDAK ADAPTER

FOR AUDAK L6 CARTRIDGE

NET .82

NOTE: Plug-in shells supplied with changer accommodate all other standard cartridges such as GE, Electro-Voice, etc.

AUDIOGERSH "MIRACORD" CHANGER AND PLAYER

WITH GE RFX-052A CARTRIDGE AND DIAMOND SAPPHIRE STYLUS



3-speed completely automatic, push-button controlled, record changer with the "Magic Wand" spindle. Plays 7", 10" and 12" of some speed intermixed. Four pushbuttons: **START**, Starts mechanism or changes to next record; **FILTER**, Eliminates old record surface noise; **REPEAT**, repeats record; **PAUSE**; Adjusts time lapse between records from five seconds to five minutes. Shuts off after last record. Record capacity: 8 — 12" or 10 — 7" records (or a corresponding mixture of both) or 10 — 7" records. Size: 12 1/2" x 10 1/4" requiring 4 1/2" above and 2 3/4" below mounting board. Less 45 RPM automatic spindle listed below but with 45 RPM adaptor for single play. Dual voltage 110-220 or 200-220 60 cycle AC. Shpg. wt. 15 lbs. Model **XA-100** with **GE-RFX-052A** Diamond and Sapphire Stylus. Net 78.45

Model **XM110A** Miracord Manual Record Player. 3 speed single-play transcription quality. 45 RPM automatic spindle for **XA100** changer. Net 4.41

GRAY HIGH-FIDELITY TURNTABLE AND TONE ARM COMBINATION



- COMPLETE 3-SPEED TURNTABLE AND ARM
- VISCOUS DAMPED TRANSCRIPTION ARM

An extremely rugged, rigidly designed unit which eliminates rumble and vibration with a massive turntable and motorboard assembly. Handles up to 16" professional transcriptions and all three standard speeds. A 4-pole, heavy-duty induction type motor has shaft engaging external rim directly without intermediate idlers to cause frequency distortion, wow or flutter. Extra-long tapered steel bearing precludes turntable, wobble and noise.

Unit uses Gray 108C Viscous-Damped Tone Arm but will accommodate other popular tone arms. Arm has a cue light whose beam of light provides ample illumination for placing pickup on record. All type of cartridges including GE triple play are accommodated.

Top of the heavy completely shockmounted motorboard has a lustrous satin copper finish. For 110-120V, 60 cycle AC. Size 16"x20". Shipping wt. less base, 59 lbs.

Model **HF-401** less base. Net 124.50

Model **HF-503** Pebble Gray Woodbase 16"x20"x6 1/2". Shpg. wt., 3 lbs. Net 20.00

Model **HF-400** Turntable only. Net 89.00

Shpg. wt., 5 lbs.

Model 108C Viscous-Damped Pick-up Arm only. Net 39.95

Shpg. wt., 3 lbs.

GARRARD "CREST" MODEL T 3-SPEED MANUAL RECORD PLAYER



Compact, efficient 3-speed manual record player for fine reproduction where a changer is not desired yet incorporating all of the fine record playing features of the famed Garrard changers. Features automatic start and stop — starts when tone arm is lifted, automatically shuts off at end of record. 4-pole rumble-free constant speed motor and heavy balanced turntable for fly-wheel action. Easy stylus pressure adjustment with knurled knob of tone arm. The universal shell fits all popular magnetic, crystal or ceramic hi-fi cartridges. Ballbearing-mounted pull-away idler wheel prevents flat spots on idler wheel when player is not in use and assures longer wear and smoother performance. Professional-type finger lift for safe manual handling of tone arm and tone arm clip to lock arm in place when not in use. Simple 45 RPM adaptor plays records without spindlers or plugs. Heavy velvet covered turntable provides record protection. Condenser-resistor network across switch eliminates "pop" shutoff noise. Size 13 3/4"x12 3/4" and requiring 3 1/4" clearance above and 3 1/2" below mounting board. For 110/130-200/250 volts 60 cycle AC. Line cord and pickup cable terminating in jack. Less cartridge. Shpg. wt., 13 lbs. Model **T Garrard "Crest"** Net 31.85

REK-O-KUT TRANSCRIPTIONS TURNTABLES

RONDINE JR. 2-SPEED TURNTABLES

MODEL L-34 33-1/3 and 45 RPM MODEL L-37 33-1/3 and 78 RPM

"RONDINE JR." MODELS L-34, L-37

Rondine Deluxe Model B-12H

High quality, dual-speed, low-priced turntables for hi-fi and commercial use. Internally rim-driven cast aluminum turntables precisely lath-turned and dynamically balanced. Floating idler virtually isolates 4-pole induction motor and turntable. Permanently offset strobe disc for instantaneous speed checking. Size 12"x15" requiring 1 3/4" above deck and 6 1/2" below deck. Gray hammettone finish. 110V 60 cycle AC only. Shpg. wt. 15 lbs.

Model L-34 33-1/3 and 45 RPM. Net 49.95

Model L-37 33-1/3 and 78 RPM. Net 49.95

Model B-12 3-Speed Rondine—15 3/4"x14" Clearance 1 1/2" above and 6 1/2" below deck. Shpg. wt. 17 lbs. Net 79.95

Model B-12H Rondine Deluxe Turntable is powered by constant speed hysteresis motor for finest performance. Shpg. wt. 17 lbs. Net 129.95

Model B-12H

GARRARD MODEL 301 PROFESSIONAL TURNTABLE



- HEAVY DUTY MOTOR
- VARIABLE SPEED CONTROL
- FREE-FLOATING ISOLATED MOTOR MOUNT
- PERFECTED TURRET-DRIVE MECHANISM
- BUILT-IN PRESSURE LUBRICATION SYSTEM

A 3-speed hi-fi turntable designed to professional specifications. Phosphor bronze frictionless bushing and bearing eliminate noise and rumble. Oversized grease housing and knurled knob to additional spindle lubrication. Motor and motorboard spring-suspended and vibration-free. 12" diameter 7 1/2" cast aluminum dynamically balanced turntable with negligible wow. Size 16"x13 3/4" requiring 2 1/2" above and 3 1/2" below motorboard. Supplied with strobo-copic disc, individual inspection report and owner's manual. Shpg. wt. 20 lbs.

Model 301

Net 87.22

LAFAYETTE

LEADERS

High Fidelity

SPEAKERS &

SYSTEMS

UNIVERSITY Hi-Fidelity SPEAKERS

UNIVERSITY MODEL 6201 HI-FI COAXIAL
 Enjoy balanced response and full range reproduction with this 12" 25-watt high fidelity coaxial speaker. Low frequencies handled by large, one-piece molded cone, high frequencies by a tweeter driver unit and horn coaxially mounted. Tweeter provides high frequency arc that blends with low frequency output to form a uniform area of sound 80° wide. A built-in, 2000-cycle crossover network assures maximum efficiency of the woofer and tweeter.
 University Model 6201 48.51

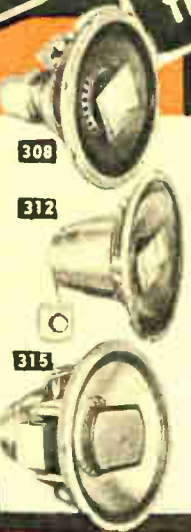

MODEL 308 8" TRIAXIAL SPEAKER
 Nothing else like it! An 8" 3-way triaxial speaker for high fidelity installations where space is at a premium and quality is not to be compromised. Special diaphragm and voice coil assembly operating with exclusive University all-Alnico V magnet provides response down to 30 cycles. Full bodied mid-range is reproduced from patented "diffu-

sion" device through a 1,000 cycle mechanical crossover, and clean brilliant highs from the compression driver built wide angle tweeter to 1,000 cycle through 2000 cycle electrical crossover. Impedance 8 ohms, power capacity 25 watts, 8 7/8" diameter, 10 1/2" deep. Shpg. Wt. 5 lbs. NET 36.75

MODEL 312 12" TRIAXIAL SPEAKER SYSTEM
 A new challenge by University in the 12" field. Embodies the "Diffusone" principle for full-bodied mid-range and the new HP-200 Super tweeter for clean, brilliant highs. Alnico V exclusive V magnet and duraluminum voice coil suspension used in woofer section results in deep rich and highly efficient bass response. Mechanical crossover at

1,000 cycles and built-in L/C electrical dividing network at 5,000. Complete with high frequency balance control wired to 36" extension. Has an e 10-17,500 cycles, 25 watts power capacity. Imp d-ance 8 ohms 12 1/2" diameter, 8" deep. Shpg. Wt 12 lbs. UNIVERSITY 312..... NET 63.21

MODEL 315 15" TRIAXIAL SPEAKER
 A triaxially mounted 3-way speaker system designed with emphasis on balance and presence. Tailored so carefully that no "balance" control is needed. Reproduces with such full bodied clarity that its superior quality of presence is readily apparent. Built around the sensational 12-W woofer assembly, mid-range is provided by the patented "diffusione" device with 1,000 cycle mechanical crossover and the highs from a compression heavy duty driver

unit with angle tweeter through an L/C electrical network crossing over at 5,000 cycles. Very high frequencies further diffused by apertures in horn mouth acoustic screen. Heavy all die cast aluminum speaker super-structure ensures rigid trouble free assembly. Overall response 30-15,000 cycles. Impedance 8 ohms. Power capacity 30 watts. Dimensions 15 1/2" diameter, 12" deep. Shpg. Wt. 31 lbs. UNIVERSITY 315..... NET 129.36

ALTEC LANSING HIGH FIDELITY SPEAKERS

The new Altec-Lansing duplex speakers, models 601A and 602A, are guaranteed by Altec-Lansing to have a frequency range from 30 to 22,000 cycles. Both of these speakers are full 2-way speaker systems and include the Altec N3000A network which provides a crossover at 3,000 cycles. The frequencies between 30 and 3,000 cycles are reproduced by the high efficiency cone speaker with 3 aluminum edge wound ribbon voice coil. All frequencies from 3,000 to 22,000 cycles are produced smoothly and efficiently by the model 3000A high frequency unit mounted on the pole piece. Three steps are provided on the network for adjustment of the high frequency level. Smooth distribution is effected throughout by the use of a sectionalized horn similar to that in the already famous 604B Altec-Lansing speaker. These speakers were designed primarily for high fidelity custom home music systems and have a power handling capacity of 20 watts continuous, 30 watts peak. Both speakers are identical with the exception that the model 601A is on a 12" frame and the 602A is on a 15" frame. Shpg. Wt. 12" size, 16 lbs. Shpg. Wt. 15" size, 25 lbs.
Altec-Lansing model 601A, 12" coaxial speaker, including network..... NET 99.00
Altec-Lansing model 602A, 15" coaxial speaker, including network..... NET 114.00

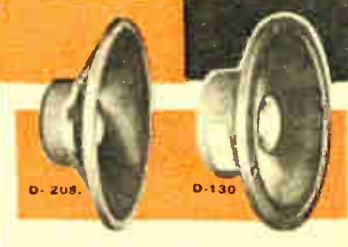

JIM LANSING SIGNATURE SPEAKERS
MODEL D-130 15"
 The famous Jim Lansing precision engineered and constructed speakers are made to supply the finest multi-speaker performance possible without compromise, dependent only on your audio system. The 15-inch D-130, with a power handling capacity of 25 watts, has a virtually flat frequency response from 50 to 12,000 cps. Has a one-piece molded cone with aluminum high frequency center diaphragm. Uses an edge wound ribbon voice coil with a diameter of 4" 3/8. Alnico V permanent magnet. Nominal impedance 16 ohms. Completely enclosed metal mounted in heavy, rigid aluminum frame. O.D. 15 1/2", depth 6 1/2". Shpg. wt. 26 lbs.
Jim Lansing D-130 Signature Speaker..... 76.00

JIM LANSING MODEL D. 208. 8"
MODEL D-208. 8"
 A moderate priced 8" model with a power input of 12 watts. Has 1 1/2" Alnico V PM, edge wound ribbon voice coil and aluminum high frequency center diaphragm vented to eliminate unwanted compression effects. Impedance 8 ohms. O.D. 8 1/2", depth 2 1/2". Voice coil diameter 2". Shpg. wt. 9 lbs.
Jim Lansing Model D-208..... 25.92

Electro-Voice

RADAX COAXIAL SPEAKERS
 Discovery of the E-V RADAX Principle provides an economical and super-efficient method of utilizing two separate coaxially mounted cones to divide the audio spectrum... while both operate from only a single voice coil.
 Built-in mechanical crossover from the low-frequency cone to the high-frequency propagator permits design of each cone for optimum response. This provides a true coaxial two-way speaker system that assures clean, sparkling wide-range reproduction. Frames are extra sturdy. Both speaker cones are moisture inhibited.
Model SP8B Radax Super-Eight. 8-inch coaxial speaker. Resonance 65 cps. 15-20 watts. Response 35-13,000 cps ± 6 db. 16 ohms impedance. Sens. rtg. 44 db. Crossover, 6000 cps. 1 lb. Alnico V magnet. 8 1/2" diam., 7" baffle opening, 4 1/2" depth behind mtg. panel. Shpg. wt. 8 1/2 lbs. List Price.....\$47.50 Net 27.93
Model SP12B Radax Super-Twelve. 12-inch coaxial speaker. Resonance 50 cps. 15-20 watts. Response 30-13,000 cps ± 6 db. 16 ohms impedance. Sens. rtg. 45 db. Crossover, 4500 cps. 1 lb. Alnico V magnet. 12 1/2" diam., 11" baffle opening, 5 1/2" depth behind mtg. panel. Shpg. wt. 9 1/2 lbs. List Price.....\$49.50 Net 29.11
Model SP12 Radax Super-Twelve. 12-inch coaxial speaker. Resonance 43 cps. 25 watts. Response 30-13,000 cps ± 5 db. 16 ohms impedance. Sens. rtg. 48 db. Crossover, 4000 cps. 3 lb. Alnico V magnet. 12 1/2" diam., 11" baffle opening, 7 1/2" depth behind mtg. panel. Shpg. wt. 26 lbs. List Price.....\$93.00 Net 55.86
Model SP15 Radax Super-Fifteen. 15-inch coaxial speaker. Resonance 40 cps. 30 watts. Response 30-13,000 cps ± 5 db. 16 ohms impedance. Sens. rtg. 48 db. Crossover, 3000 cps. 5 1/2 lb. Alnico V magnet. 15 1/2" diam., 13 1/2" baffle opening, 9" depth behind mtg. panel. Shpg. wt. 44 lbs. List Price.....\$130.00 Net 76.44



The G.E. A1-400 Coaxial Speaker
 An exceptional, wide angle dispersion loudspeaker for discriminating high fidelity enthusiasts. New concept of smooth realistic reproduction made possible by exclusive new G.E. developments in conical design. Uses high efficiency Alnico "V" ring magnets and aluminum base voice coils in both bass and treble speakers. Response, 40 to 15,000 cps. Int. ± 5 db. Power rating 25 watts integrated program material. Impedance 8 ohms. No external crossover network required. 12 1/2" dia. x 6 1/2" deep. Wt. 11 1/2 lbs. Shipping wt. app. 9 lbs.
GE A1-400 Speaker..... NET 41.11
GE S1201A 12-inch
 This deluxe 12" Alnico V PM speaker is very popular for home hi-fi units, public address, etc. where 25 watts handling power with 50-13,000 cps frequency range at moderate cost makes it a universal favorite. Incorporates late speaker design developments for brilliant highs, mellow bass response. Heavy Alnico V magnet, aluminum base voice coil. Impedance 8 ohms. 7 1/2" deep. List \$33.95. Shpg. wt. 9 lbs.
GE S1201A 12" Speaker..... NET 19.95

NEW UNIVERSITY HI FI SPEAKER

MODEL UXC-123 12" TRIAXIAL SPEAKER
 This fine speaker is characterized by an exclusive "reciprocating flares" horn tweeter projected tri-axially through the center of the woofer. A full-bodied mid-range is provided by a Diffusone device crossing over mechanically at 1000 cps and built-in L/C electrical dividing network crossing over at 5000 cps. Contains a 1 1/2 lb. Alnico V Gold Dot Magnet. Features smooth and wide response from 45-17,500 cps and handles 25 watts on integrated program. Impedance 8 ohms. 8 1/2" deep. Supplied with built-in brilliant control wired to 36" cable. Shpg. wt., 7 lbs.
UNIVERSITY UXC-123..... NET 58.31

MODEL UXC-122 12" COAXIAL SPEAKER
 This 12" Diffusone coaxial speaker features a unique design with 1000 cycle mechanical crossover. The high frequency response is extended through dual coaxial horn loading. This results in full fidelity everywhere in the room and an undistorted response without loss of high at listening points progressively off speaker axis. Contains 1 lb. Gold Dot super-sensitive all-Alnico V magnet for high efficiency. Response from 45-13,000 cps; handles 25 watts of integrated program; 8 ohms; 4 3/4" deep. Shpg. wt., 5 lbs.
UNIVERSITY UXC-122..... Net 29.15

WILCOX-GAY

PRESTOMATIC

PUSH-BUTTON KEYBOARD TAPE RECORDERS

W-G TAPE RECORDIO

MODEL 5A



MODEL 5F

119.97

Wilcox-Gay, pioneer name in home recorders, has achieved in the Recordio a significant advance in tape recorder progress. Never before has a unit so rich in fidelity, range and tone qualities been available for professional and home recording. All are dual-track, using top and bottom halves of tape to make 2 recordings.

THE SPECIAL MODEL 5A W-G TAPE RECORDIO

Frequency Response: 80 to 8,000 cycles. Wow & Flutter: .35 @ 7 1/2 IPS, .2 @ 15 IPS. Signal to Noise: 35db minimum. Speed Selector: 3 1/2 and 7 1/2 IPS. Speakers: 1" Round. Reels: Uses 3", 5", 7" reels. Record Lock Button: Prevents accidental erasure. Radio-Phono-TV Input Jack. This low level input permits recording from Radio, Phono, or TV. Also used as low level constant output. Microphone: Humi-Seal crystal. Record Level Indicator: The "Easy View" neon indicator shows at a glance "Normal" and "Overload." Red-Lite: Indicates unit is ready to record or play. External Speaker Jack: For telephone, monitoring or deep rich bass tone. Erase: Automatic, positive, exclusive. Volume Control: Bass and treble compensated for best reproduction. Power Requirement: 115V AC-60 cycle. Public Address System: Speeches or entertainment can be recorded at the same time the unit is being used as a public address system, with external speaker. Amplifier: 3 watts output. Fast Rewind and Fast Forward: Rewinds 7" tape in less than 2 1/2 minutes. Duplicating Tapes: Using two units—exact copies can be made. Tube Complement: 6AV6, 6AQ5, 12AX7, 6X4. Standard Accessories: Microphone, 3" reel tape, 5" empty reel, line cord. Size: 14" x 12" x 8". Wt. Approx. 26 lbs. U.L. Approved. Net 86.63

Model 5A, Tape Recorder—Dual Speed—3 1/2 and 7 1/2 IPS. List, 129.95
 Model 5M, Similar to above, but 2 tone case, larger speaker, slightly larger case with extra storage space. Net 97.47

Model 5B, Tape-Recordio—Dual Speed—3 1/2 and 7 1/2 IPS. Dual Speakers—Tape Timer. List, 169.95. Net 105.37

W-G MODEL 5F THE DELUXE TAPE RECORDIO

Never before has a unit so rich in fidelity, range and tone qualities been available for professional and home recording. Powerful enough to meet any volume requirement, sensitive enough to pick up the faintest whisper. High Fidelity, Stereophonic 3D Sound. Frequency Response: 70 to 10,000 cycles. WOW & FLUTTER: .3 @ 7 1/2 IPS, .2 @ 15 IPS. SIGNAL TO NOISE: 35 db minimum. SPEED SELECTOR: 3 1/2 and 7 1/2 IPS. PUSH-PULL AMPLIFIER: Delivers 7 watts of undistorted output. DUAL SPEAKERS: Two 5" x 7" speakers. REELS: Uses 3", 5", 7" reels. VISUAL TAPE INDEX: Any selection on tape located quickly by number. PUSH-BUTTON TYPE RECORD LOCK: Prevents accidental erasure. THREE EXTENSION SPEAKER JACKS: To allow an arrangement of external speakers. RADIO-PHONO-TV INPUT JACK: This low level input permits recording from Radio, Phono or TV. Also used as low level constant output in "play" position. EASEL MICROPHONE: Humi-Seal Hi-Fi Crystal. TWO RECORD LEVEL INDICATORS: "Normal" and "Overload." TONE CONTROL: Full range variable control from maximum brilliance to a deep rich bass tone. VOLUME CONTROL: Bass and treble compensated for best reproduction. PUSH-PULL: Recording and playback. POWER REQUIREMENT: 115V AC-60 cycle. TWO STORAGE COMPARTMENTS: To carry spare tape—microphone, built-in line cord and patch cords. PUBLIC ADDRESS SYSTEM: Speeches or entertainment can be recorded at the same time the unit is being used as a public address system, with external speaker. REMOTE CONTROL: Built-in accessory outlet permits "ON" and "OFF" operation from a distance. FAST REWIND AND FAST FORWARD: Rewinds 7" tape in less than 2 1/2 minutes. DUPLICATING TAPES: Using two units—exact copies can be made. TUBE COMPLEMENT: 6Y3, 12XX7, 12AX7, 6AQ5 (2). STANDARD EQUIPMENT: 5" reel tape, empty 5" reel, microphone, built-in line cord, Radio, TV, Phono recording cord. SIZE: 19" x 15 1/2" x 14 1/2". Wt. 35 lbs. U.L. Approved. Model 5F, Tape-Recordio—Dual Speed—3 1/2 and 7 1/2 IPS. Push-pull Output. Dual Speakers. Tape Timer. List, 199.95. Net 119.97

W-G RECORDIO ACCESSORIES

- MC-12 Remote Hand Control with 18 ft. Connecting Cable and Plug for 4A, 4B, 4F, 5F Series only. List, 9.95
- 9-2221-1 Microphone extension cord complete with connectors 12 1/2 ft. List, 5.00
- 9-2221-2 Microphone extension cord complete with connectors 25 ft. List, 5.50
- 20-233 Radio-Phono Recording Cable for 3, 4 and 5 series (except 4C10). Net, 3.30
- 9-2249 Patch Cord for Duplicating Use with 3, 4 and 5 series (except 4C10). Net, .87

Lafayette HIGH FIDELITY RECORDING TAPE

GUARANTEED SPLICE FREE — ALL LAFAYETTE TAPE SOLD ON A MONEY BACK GUARANTEE

Lafayette
 Greatest Tape Buy Ever!

1200 FT. — 7" REEL
 PLASTIC BASE
 HI-FI TAPE

NEW! Time + 1/2
Recording Tape

1800 FT. — 7" REEL
 PLASTIC BASE HI-FI TAPE

1.59
 ea.
 Lots of
 10
 single, each 1.69



LAFAYETTE made a terrific deal with one of the leading manufacturers of recording tape to supply us with their regular tape which sells for almost twice our price. WE GUARANTEE ABSOLUTE SATISFACTION OR YOUR MONEY BACK. The finest, professional-quality recording tape obtainable. Highest performance for thousands of playings. Red Oxide Base in a smooth, uniform coating; greater signal strength; with maximum fidelity; uniform frequency response from 40-15,000 cps.

• AN ENTIRE SYMPHONY ON ONE REEL OF TAPE!
 • NO MORE ANNOYING INTERRUPTIONS!
 Lafayette did it again! New plastic base, TIME + 1/2 High Fidelity Recording Tape at an amazingly low price! Over 1 1/2 hrs. of playing time on a single reel at 7 1/2" per second on dual track recording. At 3 1/2" per second you get 3 hours and 12 minutes. The same quality that has made the Lafayette Standard Tape the nation's outstanding value, 40-15,000 cycle response at 7 1/2" per second assures you of the finest professional quality high fidelity recordings. A true Lafayette value backed up with our Money Back Guarantee. You be the judge—try it!
 LAFAYETTE TIME + 1/2 TAPE } Lots of 10, Each \$2.45 }
 1800 FT. - 7 INCH REEL } Singly, Each \$2.59

\$2.59 EACH IN
 2.45 Lots of 10

SCOTCH RECORDING TAPE NEW LOW PRICES

REEVES SOUNDRAFT "PLUS 50" AND "PLUS 100" EXTRA LONG PLAY RECORDING TAPE

\$1.58
 600 FT. REEL
 NEW LOW PRICES
HIGH OUTPUT TAPE
 Gives 8 to 12 db higher output than type 111A

Type No.	Reel	Length	List Price	1 to 11	12 or More
120A-12	7"	1200'	5.50	3.67	3.30
120A-24H	Hub	2400'	10.00	6.67	6.00
120A-24R	10 1/2"	2400'	12.85	8.57	7.71

Type No.	Reel Size	Length Feet	List Price	Net Each	
				1 to 11	12 or More
111A-15	3"	150	.85	.57	.51
111A-3	4"	300	1.50	1.00	.90
111A-6	5"	600	2.25	1.58	1.46
111A-12	7"	1200	3.50	2.45	2.28
111AP-12	7"	1200	5.20	3.47	3.12
111A-24H	Hub	2400	8.50	5.67	5.10
111A-24R	10 1/2"	2400	10.90	7.27	6.54
111A-48H	Hub	4800	17.00	11.33	10.20
111A-48R	14"	4800	22.10	14.73	13.26

The new Dupont Mylar plastic, incorporating strength with super thin base makes possible up to double the playing time on the same size reel. You can now record an entire symphony on a single reel, eliminating annoying interruptions. All on plastic reels except "Plus 100" is fiberglass with filled center, 5/16" hole.

REEVES NO.	REEL SIZE	LENGTH FT.	LIST PRICE	SINGLY	NET EACH IN LOTS OF 3
PL-9	5"	900'	4.40	2.87	2.58
PL-18	7"	1800'	7.95	5.19	4.67
XP-12	5"	1200'	4.75	3.72	3.49
XP-24	7"	2400'	9.00	7.06	6.61
XP-52	10 1/2"	5200'	22.50	17.64	16.54

TAPE RECORDING ACCESSORIES

400 AUDIO HEAD DEMAGNETIZER

7.06



In normal use, the recording head which left the factory unmagnetized tends to accumulate magnetism. This may substantially increase the noise level. The audio demagnetizer will remove any permanent magnetism from the head. Operates on 110V and 60 cycle AC. Shpg. wt., 1 lb. Audio 400 Demagnetizer Net **7.06**

METAL TAPE STORAGE CHEST

2.99



STANDARD CASE

Standard Case: Sturdy all steel carrying case. Holds 12 7" or 5" reels and cassettes. Twin snap locks for positive closure. Perfect portability—ideal for filing and storage. Guards against exposure to moisture and accidental erasure. Finish in platinum grey hammerloid. Handle folds for compactness. Includes index cards for quick identification. Metal separators hold each reel erect. Shpg. Wt. 5 lbs. ML-60 Net ea. **2.99**



7 INCH EMPTY PLASTIC REELS

INDIVIDUALLY BOXED

Fine plastic reels for recording tape. MS-267 in lots of 6, Each .38 Singly, Each .45

MAGNETIC TAPE SPLICER

1.47



An excellent accessory that splices tapes accurately and eliminates joint noise. Both ends of tape are cut simultaneously. Nicked brass finish. Wt. 1 lb.

MS-289..... **1.47**

METAL STORAGE CANS

Can holds 7" 1200 ft. tape reel. Gives ultimate in protection to precious recordings. Handsome finish of grey hammerstone enamel. Cans are ribbed for stacking—give maximum storage in minimum space. Precision fit makes opening and closing easy. Fit perfectly in chests shown above. Shpg. Wt. 8 oz.

Net ea. 44c
Lots of 6, ea. 42c



46c

TELEPHONE PICKUP

FOR RECORDING TELEPHONE CONVERSATIONS

Induction telephone pickup. Telephone conversations can now be picked up with no tapping of wires or special telephone circuits. Simply place the phone base, either cradle or upright type, on the pickup platform and connect the leads to the high impedance input of any medium gain audio amplifier, or directly to any tape, disc or wire recorder.

STOCK NO. MS-16

\$2.95



PERMOFLUX TELEPHONE PICKUP



Newly designed telephone instrument for picking up both sides of a telephone conversation. Can be used with either cradle type or old style telephones. Output of pickup can be fed directly to microphone input of any tape, wire or disc recorder—or amplifier. No electrical connection to telephone is necessary; pick up clips easily and quickly on to telephone earpiece. This method of pickup makes possible a high degree of fidelity—assuring reliable recordings of important telephone conversations. Size: 3 1/2" dia., 1 1/2" d. Complete with 8 ft. of shielded cable. Shpg. wt., 8 oz. List, 17.50

MS-291

..... **13.29**

ELECTRO SCRIBER TELEPHONE PICKUP

NEW WAY TO AMPLIFY, RECORD, AND MAKE A PERMANENT RECORD OF YOUR TELEPHONE CONVERSATIONS.

Avoid the anxiety and expense resulting from "re-hash" of long distance conversations. Simply place phone base on Electro Scribe. Plug Electro Scribe into amplifier if improved reception is desired, or into recorder if a permanent record is desired. Turn on amplifier or recorder and relax. The conversation will be clearly audible to you or anyone else in the room, or you will have a clear permanent record, if recorded.

MS-220 — Model ES701 — for standard cradle phone **7.35**
MS-221 — Model ES702 — for push button phone **8.53**

EDITALL TAPE SPLICER



EDITALL TAPE SPLICER

Designed by the tape editor of a major network, the EditAll splicer speeds cutting without producing fatigue. Used by broadcast stations, networks, and recording studios. An absolute necessity in building a library of tape recordings. Solidly made of precision-machined Duraluminum. Holes provided for convenient mounting.

MS-290

..... **6.50**

FLAHAN TAPE THREADER

IT'S NEW!
THE TAPE THREADER YOU'VE BEEN ASKING FOR!

At last! No more awkward fumbling, threading a reel. Just place the tape against the reel, slip your Flahan threader over the capstan shaft and over the empty reel. Tip of threader holds the tape firmly against the reel. A few turns on the crank, and you're ready to play or record. Can be used as a manual crank to rotate reel by placing tip in slot nearest spindle. Saves time—saves tape. Shpg. wt., 2 oz.

MS-222

79c



LEADER-TIMER TAPE

150 ft. x 1/4" roll. Has 1 second interval markings for 3 1/4", 7 1/2" and 15" per second speeds.

Scotch 43

Net **40c**



SPLICING TAPE

Pressure-sensitive tape made especially for splicing and editing magnetic tapes. Wound on handy metal dispenser.

Scotch 41-1/25, 1/2" x 150 n. Net **35c**
Scotch 41-7/32L, 7/32" x 66' Net **52c**

SCOTCH EMPTY PLASTIC REELS

Supplied with their own index box.

All plastic except as indicated.

Type No.	Size	List Price	1-11 or more Each	12 Each
RB-3	3" (150')	.25	.17	.15
RB-4	4" (300')	.55	.37	.33
RB-5	5" (600')	.65	.44	.39
RB-7	7" (1200')	.75	.50	.45
RB-7P*	7" (1200')	1.25	.84	.75
RB-10 1/2M*	10 1/2" (2400')	4.50	3.00	2.70
RB-14M*	14" (4800')	8.70	5.80	5.22

* Metal † Plastic Professional for ILLIP Tape ‡ NARTB Metal

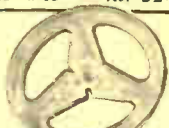

ROBINS "GIBSON GIRL" SPLICER



Cuts 2 rounded indentations in the tape splice, leaving the edges of the tape which contact parts of the recorder entirely free of adhesive. Adhesive deposited on initial parts of recorder is a frequent cause of wow and flutter. As little as 1/4" tape need be removed. Shpg. wt., 1/2 lb.

MS-288

Net **\$6.25**

ADHESIVE REEL LABELS

Convenient press-on adhesive labels for positive identification of tape reels. Easy to apply or remove.

ATTA-GLANCE DISCS

CATALOGING, INDEXING DISCS.

The Atto-Glance tape selector disc fits on the spindle and revolves with the reel. It combines I.P.S. timing, editing, indexing, and cataloging right on top of the reel for fast easy reference. Simple to select starting and finishing positions for each subject recorded. Permits accurate editing, indexing and cataloging.

MS-223, 5" dia. Each **15c**
8 for **1.00**
MS-224, 7" dia. Each **15c**
8 for **1.00**



SHURE REPLACING HEADS

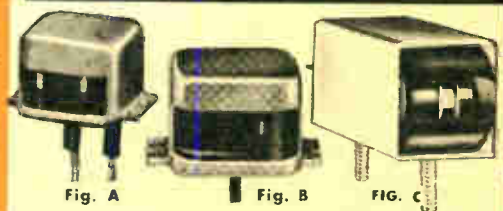

Fig. A

Fig. B

FIG. C

Half track (upper track) replacement heads for tape recorders. All are high impedance except * is low. Type TR5B equipped with Cinch plug and 14" insulated leads. Average shpg. wt. 1/2 lb.

SHURE NO.	FIG.	FUNCTIONS	REPLACEMENT FOR	LIST PRICE	NET EACH
815*	A	RECORD. PLAYBACK ERASE	BELL RT-65 REVERE T10C, TR200 SHURE TR5, TR5H	15.00	8.82
815H	A	RECORD. PLAYBACK ERASE	REVERE T500, TR600 TAPEMASTER TH21, PT121, PT125	15.00	8.82
816	B	RECORD. PLAYBACK	AMPRO 730, 731 MASCO R-3, M-60 SHURE TR6C	12.00	7.06
817*	C	RECORD. PLAYBACK	RCA SRT-403, 402, 401 WILCOX GAY 3A11 SHURE TR16A	9.00	5.29
TR5B	A	RECORD. PLAYBACK ERASE	REVERE T-700, TR800, TR-20 SHURE TR5D	17.00	10.00
TR16*	C	RECORD. PLAYBACK	WILCOX GAY 3A10, 2A-10B	9.00	5.29

HIGH-FIDELITY CARTRIDGES and ACCESSORIES

GENERAL ELECTRIC PHONO ACCESSORIES

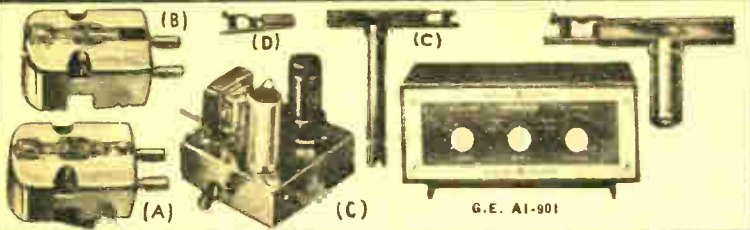

NEW SERIES "A" CARTRIDGES WITH INDIVIDUALLY REPLACEABLE SLIDE-IN STYLI

"TRIPLE-PLAY" CARTRIDGES (A)

These convenient dual-stylus "Triple-Play" variable reluctance cartridges do the work of two cartridges. A simple twist of the knob brings either long-play or standard stylus into position and eliminates plug-in heads. With .001" and .003" replaceable styli. Net 8.20
RPX050A—List \$13.95

SINGLE STYLUS CARTRIDGES (B)

Variable reluctance cartridge with replaceable sapphire stylus for long play (33 1/3, 45 RPM) records. Provides smooth, wide range reproduction. Baton type styli used in all models. Requires preamplifier. For pickup arms with mounting centers. Shpg. wt. 6 oz. Net 5.85
RPX041A—List \$9.95
RPX040A—List \$9.95

DUAL-TIPPED STYLI (C)

Complete assembly with individually replaceable slide-in styli for both old type and new "A" type cartridges.

Type	Stylus	Radius	Net Each
RPJ-007A	Sapphire	.001" .0025"	3.50
RPJ-010A	Sapphire	.001" .003"	
RPJ-013A	{ Diamond Sapphire	.001" .003"	18.23
RPJ-011A	Diamond	.001" .0025"	
RPJ-012A	Diamond	.001" .003"	29.37
RPJ-012A	Diamond	.001" .003"	

SLIDE-IN STYLI (D)

Replacement for all G.E. cartridges or styli with suffix letter "A" after type no. and new broadcast series RPX145-146-147.

TYPE	STYLUS	RADIUS	NET EACH
RPJ-015	Sapphire	.001	1.96
RPJ-025	Sapphire	.0025	
RPJ-035	Sapphire	.003	
RPJ-010	Diamond	.001	15.68
RPJ-020	Diamond	.0025	
RPJ-030	Diamond	.003	

Single styli for replacement in old type single cartridges. Cannot be used in "A" type.

SINGLE-TIPPED STYLI

RPJ-005	Sapphire	.001"	2.06
RPJ-006	Sapphire	.0025"	
RPJ-001	Sapphire	.003"	
RPJ-004	Diamond	.001"	16.17
RPJ-002	Diamond	.0025"	
RPJ-003	Diamond	.003"	

FAIRCHILD MODEL 225 "MICRADJUST" MOVING COIL CARTRIDGE

This newest version of the Fairchild high compliance cartridge is more physically rugged, and has a smoother, more extended frequency response than its predecessors. Moving coil design provides linear, wide-range smooth response, flat ± 2 db to 20,000 cps. "Micradjust" feature provides micrometer adjustment of each individual cartridge in final assembly. With RPTMA "E" mounting center. With diamond stylus. Imp- 200 ohms. Requires preamplifier.
225A 1.0 Mil—microgroove—coded red
225B 2.5 Mil—professional—coded black
225C 3.0 Mil—standard 78—coded green

MODEL 280A 12" TRANSCRIPTION ARM: New improved plug-in transcription arm for music systems. Minimum tracking error. Accepts all standard types of cartridges. Shpg. wt. 6 lbs. Net 33.95
MODEL 280A
MODEL 281A 16" TRANSCRIPTION ARM: Same as above for transcription or professional 16" turntables. Shpg. wt. 6 lbs. Net 35.95
MODEL 281A



GOLDEN TREASURE CARTRIDGES

DIAMOND TIPPED

Music lovers are confronted by two major problems—how to obtain the best possible record reproduction and, at the same time, save their favorite records from wear and distortion. The four "Golden Treasure" cartridges supply the best possible answer to these problems.

RPX052A With stylus having .001" diamond tip and .003" sapphire tip. Net 22.90
List \$36.95

RPX053A With stylus having two diamond tips: .001" and .003". Net 34.05
List \$57.90

Gold-plated cartridges with diamond-tipped styli for minimum record wear and long stylus life. Wt 6 oz.
RPX061A With .001" diamond-tip styli for MG records. Net 19.96
List \$33.95

RPX063A With .003" diamond-tip styli for standard 78 r.p.m. records. Net 19.96
List \$33.95

BROADCAST CARTRIDGES

For low impedance input

Complete with styli

TYPE	STYLUS	RADIUS	NET
RPX-145	Diamond	.001	19.96
RPX-146	Diamond	.0025	19.96
RPX-147	Dual		
	Diamond	.001/.0025	34.05

Replacement Parts Kit, for Triple Play cartridge. Includes, spring, washers, plastic knob. Wt. 2 oz.
RPK009—List 30c Net 27c

GE PRE-AMPLIFIERS

Self powered preamp for use with GE or similar magnetic cartridges and pickups. Has 6SCT tube in equalizing circuit, plus pre-amp. Includes input jack and 14 output band with phono plug. For 117 volts, 60 cycles AC. 3 1/2 x 3 1/2 x 3 1/4". Complete with tube. Shpg. wt. 2 lbs.
UPX003A—List \$17.95 Net 10.55

G. E. AI-901 RECORD FILTER AND COMPENSATOR

Improve your hi-fidelity performance. Three independent filter controls combine to filter all undesirable noise, and to correct tonal balance for every record. 11 separate frequency adjustments are provided covering the entire audio-frequency range. Adds new brilliance to the oldest records and supplements the richness of good sound reproduction. Lo-cut-off control with 4 adjustments for suppression of turntable rumble, vibration, etc.; Hi-cut-off control with 4 adjustments for suppression of record scratch and high frequency distortion; compensator control with six adjustments for most widely used recording curves. Automatic bass and treble equalization. Connects between cartridge and preamp. For use with systems using G.E. or similar types of magnetic cartridges. Handsome cabinet, size 7-9/16" L x 3-9/16" D x 3-3/16" H. Shpg. Wt. 5 lbs. Net 19.55
G.E. AI-901

RECOTON — GOLDRING

Model 500 Turnover Cartridge

Entirely unique, and exclusive, among the "500" features is the push-pull coil arrangement which automatically cancels out inductive hum picked up from the radiation of changing motors and other nearby electrical devices. This feature permits users of the "500" to realize the full potential of the variable-reluctance principle and at the same time removes any annoyance which is inherent in many cartridges of the magnetic type.
The "500" will fit any tone arms having standard half-inch mounting holes; thus it may be used to replace any cartridge without alteration of playing equipment.

No. 50055 — Cartridge with two sapphire styli. Net 9.70
No. 5005D — Cartridge equipped with diamond and sapphire styli. Net 22.93
No. 500DD — Cartridge with two diamond styli. Net 36.16



PICKERING

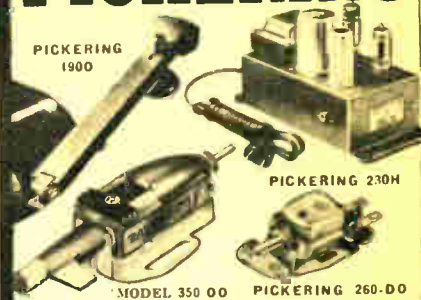

PICKERING MAGNETIC CARTRIDGES

Have received universal acclaim for their high quality and true fidelity reproduction of lateral phonograph records and transcriptions. For standard or MG records. Response essentially flat from 20 to 20,000 cps. Have new lower mass, higher compliance element .001" styli for MG .0025" and .0027" styli for standard records. Supplied with mounting clips for Garrard or Webster changers free. Shpg. wt. 4 oz.

Type	Stylus Supplied	List	Net
S120M	Sapphire .0027"	16.50	9.90
D120M	Diamond .0025"	41.50	24.90
D140S	Diamond .001"	60.00	36.00
S140S	Sapphire .001"	25.00	15.00
R150"	Less styli	16.50	9.90

Response to 10,000 cps. For 78 r.p.m. Model S-30 .003" sapphire styli. For R-150 cartridge above. Net 2.40
List \$4.00

NEW MODEL 260-DD TURNOVER CARTRIDGE WITH DIAMOND TIPPED STYLI

The new Pickering 260-DD turnover cartridge is the latest contribution to the technique of recreating recorded music. Uses 2 separate "back-to-back" cartridges with diamond tipped styli. Eliminates cartridge head removal when changing from MG to standard records. Response essentially flat 20-20,000 cps. Output 30 mv at 10 cm per second. With .001" and .0027" diamond tipped styli. Shpg. wt. 4 oz. List \$100.00 Net 60.00

MODEL 260 OS CARTRIDGE

Identical to the 260DD above except with one Diamond MG and one sapphire standard styli. Net 48.00
PICKERING 260 DS

PICKERING SERIES 240 CARTRIDGES

Same cartridges as used in 260 series but single instead of double. Supplied with holder and frame.
MODEL 0240 with MG diamond styli Net 37.50
MODEL 0220 with standard diamond styli Net 27.60
MODEL S-220 with standard sapphire styli Net 12.60

PICKERING 230H PREAMPLIFIER

Engineered to equalize properly the bass response of records and provide necessary gain for Pickering, Audax, GE magnetic cartridges. Frequency response 40-20,000 cps ± 2 db. Compensator for 6 db octave loss below 500 cps. High impedance output, average 2 volts. Turn level 56 db below maximum signal. Less than 0.2% intermodulation distortion at normal level. Self-powered. Requires 6AT6, 6C4, 6X4 (not supplied). Size 7 1/2 x 4 1/2 x 3 1/2" deep. For 117 volts, 60 cycles AC. Shpg. wt. 4 lbs. List \$40.00. Net 24.00

PICKERING "FLUXVALVE" PICKUPS

For the first time Pickering offers a very wide response (VWR), high output, replaceable stylus type turnover pickup: The Model 330 "Fluxvalve". Based upon the newly patented Fluxvalve principle, this cartridge offers features of both design and performance that were heretofore unattainable.
MODEL 350 DD—DUAL DIAMOND STYLI Net \$63.00
MODEL 350 DS—DIAMOND SAPPHIRE STYLI Net 49.50

REPLACEMENT STYLI

D 3510—.001 DIAMOND STYLI 21.00
D 3527—.0027 DIAMOND STYLI 21.00
S 3527—.0027 SAPPHIRE STYLI 7.50

PICKERING 132E RECORD COMPENSATOR TYPE 132E—List \$20.00 Net 12.00

PICKERING 190D 16" TRANSCRIPTION ARM
Radically new design for hi-fi quality. Vertical mass unbalanced to track any record—even warped ones. No spurious arm resonance, rugged bearings, minimum pivot friction, statically balanced. Easily mounts with turntable on board prox 17" x 1 1/2". Height adjusts for turntables 1/2" to 2" high. Sensible tracking force adjustment. Plug in cartridge holder.
PICKERING 190D Net 31.50

VALUE PACKED

PICKUPS

HIGH FIDELITY PICKUP

WITH 8
OUTSTANDING
FEATURES

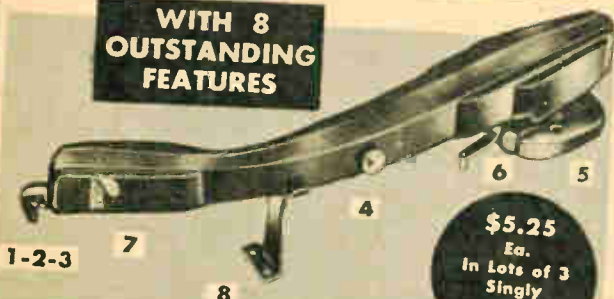

1-2-3

- 1 FREQUENCY RESPONSE 40-14,000 CPS
- 2 TURNOVER CRYSTAL CARTRIDGE
- 3 DUAL SAPPHIRE STYLI
- 4 ADJUSTABLE NEEDLE PRESSURE
- 5 BASE ADJUSTABLE FOR HEIGHT
- 6 TRIP LEVER FOR AUTOMATIC STOP
- 7 EASY FINGER LIFT
- 8 FELT PADDED ARM REST

\$5.25
Ea.
In Lots of 3
Singly
5.45

REG.
VALUE

~~\$15.00~~

We've never before seen a replacement pickup so packed with valuable features at even double the price. Not only does it have an unusually wide frequency response but it has refinements heretofore found only in expensive units. The base is adjustable to bottom of pickup may be set from 7/8" to 1 1/2" above mounting is provided in case you want to install a switch to turn off the motor at the end of the cycle. (It may be disregarded if not used). A convenient metal knob on side adjusts the spring tension so that proper needle pressure may be applied even for old and worn records. The turnover cartridge has an output of one (1) volt and is equipped with a sapphire 1 mil stylus for LP records and a 3 mil sapphire stylus for 78 RPM records. The entire unit is beautifully styled, graceful in design, and finished in an attractive maroon enamel. Even such items as the arm rest and trip lever are finely finished in gleaming nickel. Overall length 10". Shpg. wt. 2 1/2 lbs.

PK-92—SAPPHIRE LP REPLACEMENT NEEDLE 69¢
PK-93—SAPPHIRE STD. (78) REPLACEMENT NEEDLE 69¢

In lots of 3, Each 5.25
Singly, Each 5.45

REPLACEMENT STYLI FOR OLD TYPE GE CARTRIDGES

CANNOT BE USED WITH NEW "CLIP-IN TIP" ASSEMBLIES.
FOR USE ONLY WITH ORIGINAL GE TYPES.

Single needle cartridge will not fit new "A" Series.

REPLACEMENT FOR LP DIAMOND for G.E. RPJ-004

Lafayette made a lucky deal on replacement DIAMOND stylus for G.E. single stylus RPX-041 cartridge (replaces G.E. RPJ-004 stylus).

Never Before at this Price. Tests conducted on Diamond stylus have run hundreds of hours with no audible distortion and only highlights on the styli to indicate visible wear. A DIAMOND is kind to your records, maintains optimum performance. Gives long life to both record and stylus.

List \$27.50
Stock No. PK-31— Net **10.95**



\$10.95
EA.

List
\$27.50

SAPPHIRE STYLI

Fit all old types GE single needle cartridges such as RPX040-041. Will not fit "A" series.
PK15 3 mil Net 1.29
PK16 1 mil Net 1.29

3 SPEED TURNOVER HIGH OUTPUT PICKUP

REG.
VALUE

~~\$9.00~~



ONLY
3.45
In Lots of 3
Singly Ea.
3.75

- 3 VOLT OUTPUT
- TURNOVER CRYSTAL CARTRIDGE
- DUAL SAPPHIRE STYLI
- FREQUENCY RESPONSE TO 9000 CYCLES

Here is a real value in a 3 speed, pickup, complete with turnover cartridge and 2 sapphire styli to play all speeds. One stylus is 3 mil for standard (78) speed records, the other 1 mil for LP records. For all records up to 12 inch. Attractively styled and finely finished die cast arm. Easy single hole mount. Shpg. wt. 1 lb. In lots of 3, Each 3.45
Singly, Each 3.75

PK-89

REPLACEMENT STYLI FOR NEW GE "CLIP-IN" CARTRIDGES

MODERNIZE YOUR OLD TRIPLE-PLAY CARTRIDGE.
THESE ASSEMBLIES REPLACE BOTH THE OLD AND NEW SERIES "A".
ONCE INSTALLED, YOU CAN REPLACE ONE POINT AT A TIME.

DUAL STYLUS-TRIPLE PLAY DIAMOND and SAPPHIRE (LP) (78)

With individually replaceable stylus.
Fits both old and new "A" series.
GE Dual needle cartridges.

Here's a new economy in a replacement for the old GE RPJ-013 and the new RPJ-013A dual stylus. No more need to throw away the whole unit when one point is worn. With this new type you can replace either the diamond or the sapphire stylus separately. The replacement stylus listed below simply slides into place. Complete assembly with diamond and sapphire styli.

PK-65—List 31.00

NET 11.95

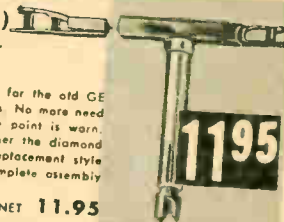

DUAL DIAMOND

Exactly as above but with both styli diamond. Replaces old GE RPJ-012 and new RPJ-012A.

PK-66

List 49.95

NET 21.50

DUAL SAPPHIRE

Exactly as above but with two sapphire styli. Replaces old GE RPJ-010 and new RPJ-010A.

PK-67

List 5.95

NET 2.25

DIAMOND AND SAPPHIRE SLIDE-IN STYLI

Individual styli that slide right into all "A" series. GE styli assemblies or individual replacements.

PK-68 Sapphire 3 Mil (78) 1.25
PK-69 Sapphire 1 Mil (LP) 1.25
PK-70 Diamond 1 Mil (LP) 10.95



GREAT LAFAYETTE BUYS

QUANTITY LIMITED

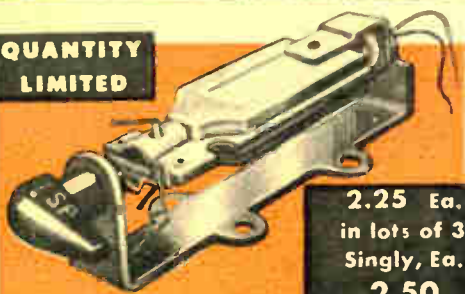

2.25 Ea.
in lots of 3
Singly, Ea.
2.50

3 VOLT TURNOVER CARTRIDGES

- High output = 3 Volts
- Dual Sapphire Styli
- Turnover Mechanism
- Excellent Frequency Response
- Easy Installation

Lafayette has gone all out to provide for the serviceman a replacement turnover phono cartridge at a price never before attained. Here is a crystal cartridge complete with two sapphire styli, turnover mechanism, mounting bracket and knob — with sufficient output to use in any record player — and yet of fine quality. All at a price that enables you to use it on any repair job. Length (less knob) 2 1/4". Ease of mounting assured by two sets of mounting holes, each set with 1/2" centers.

PK-80 Singly, Each 2.50 in lots of 3, Each 2.25

PK-86... SAPHIRE LP REPLACEMENT NEEDLE.....69¢
PK-87. SAPHIRE STD (78) REPLACEMENT NEEDLE.....69¢

Regular 8.50

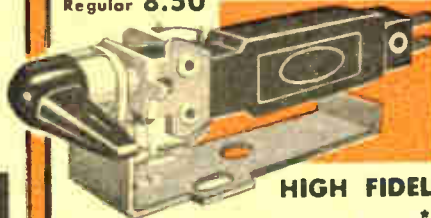

A Fantastically Low Price!

HIGH FIDELITY TURNOVER CARTRIDGE

*40-14,000 Cycles

Never before has a turnover cartridge of this quality been offered at such a price. We didn't believe it possible till we tried it. Frequency response from 40 to 14,000 cycles ± 2db! Has 2 sapphire styli to play all speeds and types of records. Needle pressure is only 5 grams on LP and 12-15 grams on 78 RPM. Output is .5 volts. Comes complete with turnover mechanism and knob. Fitt Webster, Corrad, VM, Callora and tone arms of leading manufacturers of record changers and players. This is one of the most outstanding values Lafayette has ever offered. You can't match it anywhere.

Only
2.75

PK-79 In lots of 3, Each 2.50 Singly, Each 2.75
PK-84... SAPHIRE LP REPLACEMENT NEEDLE.....69¢
PK-85. SAPHIRE STD (78) REPLACEMENT NEEDLE.....69¢

ASTATIC HIGH FIDELITY CERAMIC CARTRIDGES



Wide range 50 15,000 cps ceramic cartridges unaffected by humidity and temperature. Feature high compliance and low distortion. 7V output. Replace crystal cartridges. Replaceable single sapphire stylus. Needle Pressure 3 grams. 1/2" mt. centers. Type 51 also has additional holes for 3/4" mt. in 45 RPM changers. Type 51 2J replacement for Sonotone W750.

ASTATIC No.	STYLUS FURNISHED	NET
51-1J	.001 (33 1/3-45 RPM)	4.35
51-3J	.003 (78 RPM)	4.35
51-2J	.002 (ALL SPEEDS)	4.35

TURNOVER CARTRIDGE

Has two needle tips, one for 78 RPM and one for 33 1/3 and 45 selected by lever. Same specifications as 51 series except 10 gram needle pressure.

ASTATIC 55-TJ Net 5.59

RONETTE 3 SPEED PICKUP

- TURNOVER CARTRIDGE
- DUAL SAPHIRE STYLI

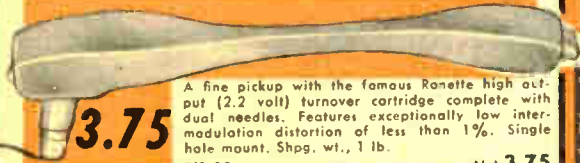

3.75

A fine pickup with the famous Ronette high output (2.2 volt) turnover cartridge complete with dual needles. Features exceptionally low inter-modulation distortion of less than 1%. Single hole mount. Shpg. wt., 1 lb.

PK-88 Net 3.75

SONOTONE TURNOVER PHONO CARTRIDGES

SERIES "2" HIGH FIDELITY

- 30 - 15,000 CPS ± 3DB
- Output 1 Volt



The new series "2" replaces the famous 9980 series. Features flat response without equalizers, high output without preamplifiers, and the protection of ceramic from temperature and moisture. Unique design — only the needle turns — insures high compliance and easy replacement. Tracking force 8 grams. Universal mount for 1/2" or 5/8" centers. Complete with 2 needles for all speeds.

TYPE 2T-S — With 2 Sapphire Styli Net 5.00
TYPE 2T-SD — With 1 Diamond and 1 sapphire Net 17.64
TYPE 2T-D — With 2 Diamond Styli Net 22.46

SERIES "3" SUPER FIDELITY

All the features of the "2" series, but with extended frequency range of 20 to 20,000 cycles, even finer compliance, tracking force of only 6 grams, and output of .5 volts.

TYPE 3T-S — with 2 Sapphire Styli Net 8.54
TYPE 3T-SD — with 1 Diamond and 1 sapphire Net 19.11
TYPE 3T-D — With 2 Diamond Styli Net 29.11

425 ASTATIC HI-FI PICKUP

With Turnover Cartridge

- 50 to 15,000 cycles!
- Dual Styli!

Unbelievable quality at an unbelievable price. Cartridge is heat and humidity proof ceramic turnover type with separate needles for LP and standard records. Real high fidelity response. Shpg. Wt. 12 oz.

PK-44 Net 4.28

ADMIRAL CARTRIDGES

Genuine Admiral phono cartridges complete with styli.

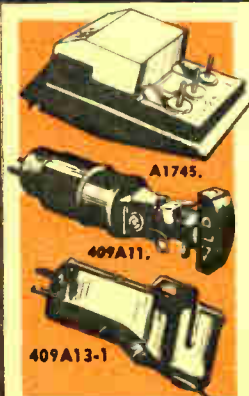

ADMIRAL A1745. Improved version of A1372. 3-prong snap-in type replaces both numbers. For Admiral changers, models RC170, RC170A, RC180, RC181 and RC182. Complete with 78 RPM osmium needle.

ADMIRAL No. A1745. Net 2.91

ADMIRAL 409A11. Barrel type turnover cartridge for Admiral changers models RC219, RC211, RC212, RC220, RC221, RC222, RC230, RC321 and RC322. Complete with two (LP and standard) osmium needles.

ADMIRAL No. 409A11. Net 5.20

ADMIRAL 409A13-1 replaced by 409A17 below

All speed single needle cartridge for models RC500, RC550, RC550A, and RC600. Complete with osmium needle.

ADMIRAL No. 409A17. Net 4.23

MAGNAVOX CARTRIDGES

Genuine Magnavox exact replacement cartridges. Complete with indicated styli.

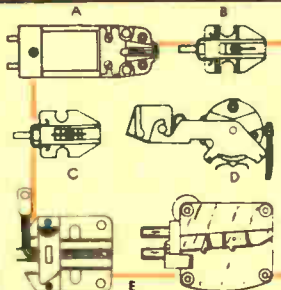

MAGNAVOX No.	FIG.	STYLI	NET
560052-4	A	OSMIUM	6.72
560101-4	B	OSMIUM	6.00
560133-4	C	REPLACED BY 560170-1	
560151-5	D	REPLACED BY 560151-9	
560151-6	D	replaced by 560151-9	
560151-9	D	Sapphire	8.00
560158-2	D	DIA/SAPPHIRE	27.00
560161-	E	OSMIUM	7.60
560169-1	F	DIA/SAPPHIRE	26.80
560170-1	C	SAPPHIRE	7.80

PHILCO PHONO CARTRIDGES

PHILCO PART 425-0011. Exact replacement for changers models M24, M24A, M25 and M26. With 2 Styli.

Stock No. PK-94 Net 6.30

Philco part 425-0016. Exact replacement for changers models M20 and M22. With 2 styli.

Stock No. PK-71 Net 5.85



ON PHONO PARTS

HIGH FIDELITY CARTRIDGE

MADE BY RONETTE OF HOLLAND

3.25
In lots of 3, ea.
single, each 3.45

- WITH THE LOWEST INTER-MODULATION DISTORTION EVER ATTAINED.
- USED IN COLLARO CHANGERS.
- OUTPUT 7 VOLTS

Lafayette brings you this famous high fidelity cartridge for use in Collaro, Webster, Garrard and VM changers. Turnover type equipped with 2 sapphire styli to play all speeds. Frequency response to 9,000 cycles. Complete with turnover mechanism and knob. Fits most tone arms of leading manufacturers of record changers and players.

PK62 (TO-284-OV) In lots of 3, each 3.25
Singly, each 3.45



SONOTONE 2T-5

(SUPERSEDES 9980-S)
Turnover Ceramic Cartridge

LOOK 

\$3.50 EA.
In lots of 5
singly, 3.75

Used in VM—Columbia 360—Webster—Crescent
With Dual Sapphire Needles
Here is a cartridge that is not only an exact replacement for thousands of units now in use, but will replace a large number of other types. Will give you such hi-fi characteristics as extended frequency range and absence of distortion for beyond most cartridges. It replaces all with the advantages of ceramic safety from humidity and heat. Has 1 mil stylus for long playing records and 3 mil for standard—both sapphire.

SPECIFY STOCK NO. PK-48
In lots of 5, each 3.50
Singly, each 3.75

REPLACES ASTATIC AC, ACD, CAC, QC, LQD
ELECTRO-VOICE 18TT, 33, 43, 48T, 96T SHURE WC Series from WC22 to WC36, W22, W26 WEBSTER ELECTRIC AX, A1, A9-1

RONETTE HIGH OUTPUT CARTRIDGE

QUANTITY LIMITED
2.75 Ea.
in lots of 3
Singly, Ea. 2.95

- Dual Turnover
- 2.2 Volt Output
- Low Intermodulation Distortion

All the fine features of the Ronette cartridge—such as less than 1% inter-modulation distortion plus the advantage of high output of 2.2 volts. Turnover type complete with 2 sapphire styli, turnover mechanism and knob. Popular type mounting and size. Fits most tone arms.

In lots of 3, Each 2.75
Singly, Each 2.95

PK-82 (TU-284-US)



ASTATIC TURNOVER ACD-G2 CARTRIDGE

\$3.50 EA.
In lots of 5

- Dual Precious Metal Needles
- Ceramic Element—Safe from Humidity and Heat

This popular Astatic Cartridge is complete with 2 styli, turnover bracket and knob. To protect your sensitive LP records, the LP needle has a .001 tip; the standard Long needle for 78 r.p.m. has .003 tip. Long life ceramic element is practically impervious to humidity and heat.

Stock No. PK-41—In lots of 5, each 3.50
Singly, each 3.98



Phono Cartridges

3.5 volt output

Guaranteed high quality exact duplicates for direct replacement of all standard cartridges such as L70, L82, L92, W60B, N10, and many others. Pin plug connectors for all 78 r.p.m.

LIST PRICE \$5.50

\$1.29 EA.
LOTS OF 5

STOCK NO PK-11
Single, each 1.49



RONETTE LP CARTRIDGE

2.25 Ea.
In lots of 3

Exact replacement for all RCA 45 RPM changers and most all other 33 1/3 and 45 players!

The famous Ronette high quality and low intermodulation distortion is now available in a high output 2.2 volt cartridge especially designed to fit the mounting of hundreds of thousands of LP record players. Complete with sapphire LP needle, at Lafayette's usual savings!

QUANTITY LIMITED
Singly, Ea. 2.45

PK-81 (RA-284-US) In lots of 3, Each 2.25
Singly, Each 2.45



Astatic Pickups

UNIVERSAL TYPE

HIGH OUTPUT-3 VOLTS
Equipped with latest Astatic cartridge. 3 volt output. For use with all-groove 2 mil needle or 78 r.p.m. 3 mil needle.

Stock No. PK-12
Single ea. \$2.99
Lots of 3, each **\$2.79**

3 SPEED TURNOVER

• High output = 3 Volts
Plays all 3 speeds—33 1/3, 45, and 78 r.p.m. Has reversible cartridge equipped with dual needles. A twist of the handle selects proper needle. List price \$12.00.

Stock No. PK-13
Single, ea. \$3.75
Lots of 3, each **\$3.45**



ZENITH COBRA CARTRIDGES

All Zenith cartridges are identified by color. Just match color to get exact replacement. *Diamond cartridge. Gold will replace green, blue & white replaces blue, gray replaces brown.

ZENITH NO.	COLOR	COBROMATIC MODEL	STYLUS	NET
S11473	Red	A4 up to "L"	3 mil-Osmium	2.79
S15780	Red & Green	All up to "L"	2 mil-Sapphire	2.79
S15222	Green	All up to "L"	1 mil-Sapphire	2.79
*S21458	Gold	All up to "L"	1 mil-Diamond	15.98
142-73	Purple	"L" & "M"	3 mil-Sapphire	3.98
142-72	Yellow	"L" & "M"	2 mil-Sapphire	3.98
142-71	Blue	"L" & "M"	1 mil-Sapphire	3.98
*142-74	Blue & White	"L" & "M"	1 mil-Diamond	15.98
142-77	Brown	"R" & "T" Turnover	3 mil-Sapphire	5.98
*142-76	Gray	"R" & "T" Turnover	1 mil-Diamond	17.98
			3 mil-Sapphire	



ZENITH 45RPM SPINDLE

FITS ALL COBROMATIC CHANGERS

Zenith S22004 spindle fits all models Cobromatic changers and eliminates use of "sliders" and other devices to insert in records. Neutral color matches any unit. Simple instructions with each one.

ZENITH S22004
Net 4.35



Star Values in Phono Accessories

SLIDE-OUT DRAWER For RECORD CHANGERS

6.95

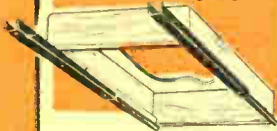

Designed for custom installations of record changers in bookcases, cabinets, tables, etc. Made of durable plywood and equipped with heavy duty steel slides which operate smoothly and quietly on ball-bearings. Slides extend drawer up to 10 1/2" beyond edge of cabinet. Supplied either blank or cut to your specifications. Unfinished wood permits your painting to suit your own decor. Size 16x16x3 1/2". Shpg. Wt. 8 lbs.

PK-47—blank Net 6.95

Same as above, cut to your specifications. Specify make and model of changer or send template.

PK-48—cut Net 7.95

WOOD BASES FOR 3 SPEED RECORD CHANGERS



3.95

Wood bases of finest veneer cut to fit Garrard changer, Garrard player, Webster, V.M. Collaro, G.I. Smoothly joined, attractively finished in dark mahogany or blond. Specify finish and model changer.

Shpg. Wt. 5 lbs.
PK-111 Base for Changers 3.95
PK-112 Base for Garrard T 3.95

BALL BEARING HEAVY DUTY DRAWER SLIDES

Stock No.
ML-34



1.95

Made of 16 gauge steel. Ball bearing, double-extension type, for mounting changers. Length 15", travel length 11", extended 22". Shpg. Wt. 5 lbs.

ML-34 per pair NET 1.95

SHORT TYPE

Same construction as above but length 13", travel length 9", extended 19". Shpg. Wt. lbs.

ML-74 per pair NET 1.50

MOUNTING BOARDS FOR RECORD CHANGERS



.95

Strong, durable 3/4" gumwood, smoothly sanded and cut out for Garrard, Webster, V.M. Collaro, G.I. Unfinished for easy staining. Specify for particular model changer desired.

Shpg. Wt. 1 lb.
PK-110 Net 95c

COMPENSATOR for G. E. CARTRIDGE

Designed for use with G.E. reluctance cartridges and preamplifiers. Five settings include LP, AES, Flat, Good 78 and Poor 78. No circuit loss is produced by use of equalizer. A must where greater bass and treble response is desired. Flat position gives maximum high frequency response. No wiring required—just plug in. With lead and plug. 2 1/2"x2"x2"—Max. depth 4". Stock No. PK-61 NET 4.95



4.95

BALANCED SOUND KIT



88c

STYLUS PRESSURE GAUGE • TURNTABLE LEVEL

The precision needle pressure gauge is compact and shallow permitting use directly on turntable to check pickup in normal playing position. Pressure read directly on scale of gauge. Easily recalibrated with an ordinary primary. Kit also contains accurate metal level to check correct horizontal plane of the turntable. Shpg. wt. 8 oz.

PK-101 Net 88c

GARRARD STYLUS PRESSURE GAUGE

Accurately measures weight of stylus on record. Calibrated in grams. Alloy construction. May be used with any tone arm. Size 4 1/2" x 1 1/2". Shpg. wt. 2 1/2 lbs.

PK-77

Net \$1.05

NET 2.45



ATOMIC JEWEL RECORD NEUTRALIZER

Makes records dust-resistant by neutralizing static charge. Clips to pickup arm. Contains radioactive material plus gold and silver. Weight only 1/50 oz.

PK-109 Net 2.99



CLARKSTAN PHONO NEEDLE PRESSURE GAUGE



Checks weight and balance of pickup arm from one gram to four ounces. Has two scales, plus calibrated dial with 4:1 scale multiplier. Indispensable to the serviceman. Shpg. wt. 1 lb.

PK-72 Net 1.47

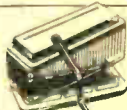

PHONO NEEDLES STOCK NO. PK-14

Synthetic ruby-tipped. Each needle microcentrically shadowgraphed. Shank is shaped to provide spring action and high vertical compliance. Each needle individually packed in a miniature transparent plastic case with lid. Regular resale price \$3.50.

Singly, ea. 89c Lots of 3, ea. 79c

NEEDLE BRUSH FOR RECORD CHANGERS

Attaches with adhesive pad with brush facing upward. At each cycle of changer arm, needle is wiped over brush, keeping it always clean. Height is adjustable. Shpg. wt. 5 ozs.

PK-107 Net 98c



LYRIC ALL-METAL RECORD CARRYING CASES

For travel and home storage of records. Feature all metal, rolled-edge construction, spring hinges and lock, and wide comfortable plastic handles. All except model 57 have embossed index for separation and protection of records. Model 57 holds records in envelopes. Attractive 2-tone wrinkle finish.

Stock No.	Model	Capacity	Shpg. Wt.	Net
PK-113	57	48-7" Records	2 lbs.	1.27
PK-114	58	60-7" Records	4 lbs.	2.29
PK-55	43	50-10" Records	6 lbs.	4.55
PK-57	46	35-12" Records	7 lbs.	4.90



RECORD BRUSH • CLEANS AS IT PLAYS

Snap right on tone arm of record player; its soft camel's hair resting lightly on record. Keeps surface clean of foreign matter, improves record life, protects needle from excessive wear. Shpg. wt. 4 oz.

PK-102 Net 59c



LYRIC DELUXE RECORD RACK

Holds 60 records of any size. Wire separators have plasticized finish. Furnished with complete indexing system including number on rack, index cord and gummed numbers. Attractive brass finish handles, new modern design, beautiful decorator colors. Shpg. wt., 4 lbs.

PK-115 Net 2.58

LYRIC BANTAM RECORD RACK

Holds 50 45 RPM or kiddie records, yet takes up only 9" of space. Steel construction with felt covered wire separators. Fully indexed. Shpg. wt., 2 lbs.

PK-116 Net 1.47

RECORD ALBUM RACK

Economical and practical record album holder that will store six 12", 10" or 7" albums. Strongly built with the dividers spot welded to base. Surfaces protected by rubber feet. Size 12" x 4 1/4" x 6 1/4". Shpg. Wt. 1 1/2 lbs.

PK-60 Net 1.19



STANDARD RECORD ALBUMS

Attractive maroon fabricoid covers and twelve sturdy kraft paper pockets make up this strong record album. Opens flat for easy accessibility of records. Index for record title and artist imprinted on inside cover. Shpg. wt. 2 lbs.

PK-73—For 10" Records 79c
PK-74—For 12" Records 95c

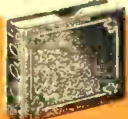

DELUXE RECORD ALBUMS

Padded covers bound with rich, brown swirl leatherette. Attractive gold embossed Gothic design on back makes this durable album especially appealing. Holds 12 records and opens flat. A set of these handsome albums will add to the appearance of your record library. Shpg. wt. 3 lbs.

PK-75—For 10" Records 1.28
PK-76—For 12" Records 1.49



UNIVERSAL 3-SPEED NEEDLE



29c ea.
Lots of 10

Over 80% discount on these famous brand needles! Offset shank with osmium tip. Plays all 3 speeds. On individual cards with manufacturer's name. Regular resale \$1.50.

PK-21 singly, ea. 39c Lots of 10, ea. 29c

FOAM TURNTABLE MAT

Fits all turntables. Prevents record slippage, cushions record drop of automatic changers, protects needle from damage due to accidental dropping of pickup arm. 9 3/8" x 3 1/8". Shpg. wt., 5 ozs.

PK-108
In lots of 3, ea. 79c
Singly, ea. 85c



COMBINATION PHONO TABLE RECORD CABINET

Here's an attractively finished unit that is not only a beautiful piece of furniture, but that has the functional design to make it really useful. A phonograph or tape recorder may be placed on the spooly sized top. The storage space has a vertical divider for 10" or 12" records or albums. The horizontal divider for 45 RPM records and albums is removable so space can be utilized for flat or upright stacking. Made of high grade beautiful furniture veneer, sturdily and solidly built, finely finished and styled. Size 28" high x 22 1/2" wide x 18 1/2" deep. Shipped knockdown. Simple to assemble. Shpg. Wt. 18 lbs. Available in mahogany or blond finish. Specify color.

Less sliding doors.
Universal 13M Cabinet MAHOAGANY 14.90
Universal 13B Cabinet BLOND 16.40



14.90

• With self leveler
brass ferrules

Similar to above except with sliding doors.

14M Mahogany Net 17.90
14B Blonde Oak Net 19.40

SPIDERS FOR 45 RPM RECORDS



Fiber Spiders, Wt. 3 oz
MS-47 Per pkg of 12
NET 25c

Metal Spiders, Wt. 4 oz
MS-48 Per pkg of 10
NET 47c

RECORD CLEANING CLOTH

Removes record static with one wipe! Eliminates noises caused by grit in grooves — no more "pops" and "clicks". Adds months to record life. Vinyl records take static charges — attract ashes — dust — grit. One wipe removes charge



cleans—lubricates—protects precious records.
PK-83—Net, ea. .35

PHONO PRICES SLASHED!

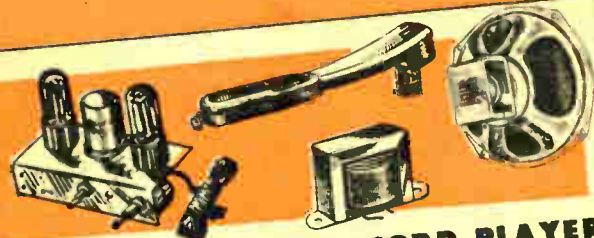

BUILD YOUR OWN RECORD PLAYER

Mr. Serviceman—Now you can build your own record player with these economical build-your-own kits. Each kit contains a rim drive motor with valved finish turntable. A 5" PM speaker with matching output transformer. A two-tube AC-DC amplifier with tone and volume control complete with tubes. 3 SPEED KIT has turnover cartridge with two needles; single speed has single cartridge with all purpose needle.

SINGLE SPEED KIT 78 RPM

Complete kit as described above. Shpg. wt. 9 lbs. Stock No. KT-10

\$9.95 ea.

3 SPEED KIT 33 1/2-45-78 RPM

Complete kit as described above. Shpg. wt. 9 lbs. Stock No. KT-11

\$12.95 ea.

3-SPEED PHONO MOTOR WITH TURNTABLE

Plays 33 1/2, 45, and 78 RPM records. Quiet dependable operation assured by rubber shock-mounted friction-type motor. Speed change control permits instantaneous meshing of proper idler for desired speed. Mounting plate 2 1/8" x 3 3/4". Depth below base mounting plate 2 1/8". For 110V 60 cycles AC. Shpg. wt. 1/2 lbs. List Price \$10.95.



SINGLE SPEED PHONO MOTOR WITH TURNTABLE

Same as above but for single speed only.

Stock No. ML-13.....Net 4.95
MO. PK-50-MOUNTING BOARD for Motor.....Net 1.46

Net 3.49
Stock No. ML-12.....Net 1.46
NO. PK-43-MOUNTING BOARD for Motor.....Net 1.46



2.91

RECORD CARE KIT

A complete kit for the care and preservation of your valuable records. Contains a spray-can of STATI-CLEAN described below to keep records dust-free and prolong their life, applicator cloth, needle brush, 12 polyethylene disc-covers for 12" records, and 15 for 10" records, plus a 25 page book on the care of recordings. Shpg. wt., 2 lbs.

Net 2.91

TAPE RECORDER MAINTENANCE KIT



The "Long Life" kit contains both a cleaner and lubricant for tape recorder heads and guides. The cleaner dissolves grease and grit, removing foreign matter from heads and tape, while lubricant reduces friction to a minimum. Recordings have greater clarity and better frequency response. Brushes contained in bottle caps. 2 oz. of each fluid. Shpg. wt., 1/2 lb. PK 103—Recorder Cleaner and Lubricant Kit.....Net 1.47

STATI-CLEAN



Sprays a fine mist which keeps your record clear of surface noise created by static (common to all vinyl records) and clean of dust attracted by the static charge. Prevents groove and needle wear caused by static-dust and keeps records lustrous. Extends their life. Two applications a year is sufficient. Enough for hundreds of records. Shpg. wt., 8 oz. PK-105.....Net 88¢

5 WATT MIKE PHONO AMPLIFIER

15.75

STOCK NO. ML-35



A compact, 5 watt amplifier with many applications; such as, low powered P.A. System, Paging System and Phonograph amplifier. It is designed to be used with either a microphone and/or phonograph. Separate inputs and gain controls are provided for microphone and phonograph. The latest compensated tone control circuit is used and is effective on both inputs. AC "on/off" switch incorporated on tone control. Inputs: 1 microphone, 1 phonograph. Controls: 1 tone, 1 microphone, 1 phonograph. Output impedance: 3.2 ohms. Supplied complete with tubes: 1—6SL7GT, 1—6V6GT and 1—6X5 rectifier. Size 8 1/2 x 5 x 5 H. For 110 Volts AC operation only. Shpg. Wt. approx. 10 lbs. 15.75

WIRELESS BROADCASTER

- Play your phonograph through any radio anywhere in the house without connecting wires.
- Talk through your radio by microphone.

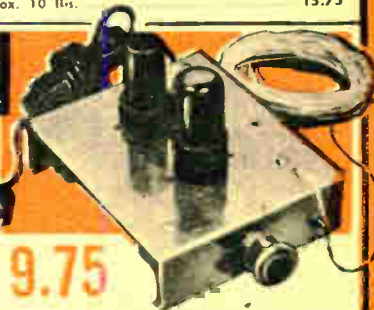

9.75

Lafayette's new wireless broadcaster will extend your enjoyment of your phonograph to every room of the house that has a radio. After connecting the phono, you simply tune in on the radio just like any radio station. Frequency adjustable for reception between 700 KC and 1700 KC on broadcast band — pick your spot so it will not interfere with regular broadcasts.

Has provision for crystal, G.E. and magnetic cartridges. Also has input for crystal microphones as well as low impedance magnetic microphone, so you can broadcast your voice through the radio. Extremely quiet and distortionless.

Plenty of power. Circuit has 12SC7, 12SL7GT tubes plus selenium rectifier. Volume control with on-off switch. Handsome gray hammett finish chassis 4 7/8" W x 5 1/2" D x 1 1/2" H. Shpg. wt., 4 lbs. Completely wired and assembled with all tubes and operating instructions. For 110V AC/DC operation.

LA-14
PA-24 Crystal microphone

NET 9.75
NET 4.25

SHIELDED PHONO LEADS



40" long shielded phono cable. Overall polyethylene insulation. Ideal for phono connections or for testers. MS-80.....Net 27c ea. In lots of 10.....24c ea.

PHONO PICKUP ARM

Shell only. With threaded stud for mounting. Takes any standard cartridge.

PK27.....\$.79ea



PHONO OSCILLATOR

4.95



For use with all types of phonos. Compact, well-built unit, tuned to broadcast band. Completely wired ready for use. Supplied with RCA type phono jack, 1—12BE6 and 1—35W4 iack, hank antenna, 6 ft. AC tubes, tank antenna, 6 ft. AC cord. For 110V AC/DC operation. Shpg. wt. approx. 2 lbs. PK-25.....4.95

2-TUBE PHONO AMPLIFIER

3.50 with Tubes



A two tube phono amplifier using a 50L6 and 35Z5 tube as rectifier. Well-built, good tone and volume. Contains volume control with switch. AT A BIG SAVING! PK-24—Two tube amplifier.....3.50 COMPLETE WITH TUBES

AC-DC Phono Amplifier

3.25



Equipped with a variable tone control and a separate volume control. Delivers two watts output. Phonograph motor connects to the amplifier. Uses 50L6, 12SQ7 and 35Z5 rectifier. For 110-120 V. cycles AC or 110-120 V. DC. Supplied with line cord and plug, but less tubes. Shpg. wt. 2 lbs. PK-23.....3.25

AND DON'T FORGET LAFAYETTE'S MONEY BACK GUARANTEE



RECEIVING TUBES

Authorized Distributors

TUBE TYPES

NEW TYPES: Manufacturers are constantly announcing new types of tubes. Lafayette will automatically stock all new types as soon as they are available. If you don't find the type you need in this listing, do not hesitate to order it; we will ship it at our regular low prices.

REPLACED TYPES: Some types are being replaced by newer, more efficient types. For instance, 1X2 is now replaced by 1X2A. When the original type is no longer available we will ship the newer version. They are always directly interchangeable.



BRAND NEW—FRESH STOCK—ORIGINAL BOXED TUBES

All tubes are brand new, individually boxed in original tube manufacturer's jobber cartons—just as they came from the tube factory. We stock the leading brands—RCA, GE, Sylvania, Hytron and Westinghouse.

12 MONTH GUARANTEE

All receiving tubes are guaranteed for 12 months from date of purchase. We will replace any tube that does not give efficient performance for a full 12 months' period. This of course does not apply to burned out or broken tubes. When you buy tubes from Lafayette you buy with confidence. Dependability is assured by continual and thorough testing of each tube in every stage of manufacture. Average shipping wt. 4 oz., per 10 tubes, 2/4 lbs.

DISCOUNTS UP TO 50/10/2%

You save money by buying in quantity. Tubes may be assorted for quantity prices as shown in price columns. In lots of 50 or more assorted tubes you may deduct an additional 10% from the second net price column.

TUBE TYPE	LIST PRICE	NET EACH IN LOTS OF 1 to 5	NET EACH IN LOTS OF 6 to 49	TUBE TYPE	LIST PRICE	NET EACH IN LOTS OF 1 to 5	NET EACH IN LOTS OF 6 to 49	TUBE TYPE	LIST PRICE	NET EACH IN LOTS OF 1 to 5	NET EACH IN LOTS OF 6 to 49	TUBE TYPE	LIST PRICE	NET EACH IN LOTS OF 1 to 5	NET EACH IN LOTS OF 6 to 49
0Y4	4.80	2.54	2.35	3B7/1291	5.70	3.02	2.79	6AL5	1.55	.82	.76	6C8G	3.85	2.04	1.89
0Z4	1.40	.74	.69	3BC5	2.00	1.06	.98	6AL7GT	4.10	2.17	2.01	6CA5	2.05	1.09	1.00
0Z4A	2.00	1.06	.98	3BE6	1.90	1.01	.93	6AM4	4.45	2.35	2.18	6CB5	7.60	4.02	3.72
0Z4G	1.70	.90	.83	3BN6	2.75	1.46	1.35	6AM8	2.75	1.46	1.35	6CB6	2.00	1.06	.98
1A3	2.50	1.32	1.23	3BY6	2.05	1.09	1.00	6AN4	4.40	2.34	2.16	6CD6G	4.95	2.62	2.42
1A5GT	2.30	1.22	1.13	3BZ6	2.00	1.06	.98	6AN8	2.95	1.56	1.44	6CD6GA	4.95	2.62	2.42
1A6	3.65	1.93	1.79	3C2	4.50	2.38	2.20	6AQ5	1.95	1.03	.96	6CF6	2.15	1.14	1.05
1A7GT	2.65	1.40	1.30	3CB6	2.00	1.06	.98	6AQ6	1.70	.90	.83	6CG7	2.20	1.16	1.08
1AB5	5.70	3.02	2.79	3CF6	2.20	1.16	1.08	6AQ7GT	3.05	1.61	1.49	6CL6	3.10	1.64	1.52
1AC5	3.50	1.85	1.71	3CS6	2.05	1.09	1.00	6AR5	3.55	1.98	1.74	6CM6	2.30	1.22	1.13
1AD5	3.50	1.85	1.71	3DT6	4.65	2.46	2.27	6AR8	3.55	1.98	1.74	6CM7	2.40	1.27	1.18
1AF4	3.60	1.91	1.76	3E6	1.90	1.01	.93	6AS5	2.00	1.06	.98	6CN7	2.25	1.19	1.10
1AG4	2.85	1.51	1.40	3F4	3.25	1.72	1.59	6AS8	3.00	1.59	1.47	6CR6	2.05	1.09	1.00
1AH4	2.90	1.53	1.42	3Q4	2.20	1.16	1.08	6AT6	1.50	.79	.73	6CS6	2.00	1.06	.98
1A5	3.05	1.61	1.44	3Q5GT	2.80	1.48	1.37	6AT8	2.75	1.46	1.35	6CU6	3.75	1.99	1.84
1AX2	2.60	1.38	1.27	3S4	2.15	1.14	1.05	6AU4GT	2.90	1.53	1.42	6D6	2.80	1.48	1.37
1B3GT	2.50	1.32	1.23	3V4	2.15	1.14	1.05	6AU4GTA	2.90	1.53	1.42	6DB8	3.50	1.85	1.71
1B4P	4.05	2.15	2.04	4BC8	3.50	1.85	1.71	6AU5GT	3.45	1.83	1.69	6DC6	2.30	1.22	1.13
1B5/25S	3.50	1.85	1.71	4BQ7A	3.25	1.72	1.59	6AU6	1.85	.98	.91	6DE6	2.05	1.09	1.00
1CSGT	2.60	1.38	1.27	4BS8	3.30	1.75	1.62	6AU7	2.25	1.19	1.10	6DQ6	3.75	1.99	1.84
1C6	3.50	1.85	1.71	4BZ7	3.45	1.83	1.69	6AUB	3.05	1.61	1.49	6DT6	1.85	.98	.91
1C7G	3.50	1.85	1.71	5AM8	2.80	1.48	1.37	6AV5GA	3.45	1.83	1.69	6E8	2.35	1.24	1.15
1D7G	3.65	1.93	1.79	5AN8	3.00	1.59	1.47	6AV5GT	3.45	1.83	1.69	6F5	2.40	1.27	1.18
1D8GT	4.55	2.41	2.23	5AQ5	1.95	1.03	.96	6AV6	1.55	.79	.73	6F5GT	2.40	1.27	1.18
1E8	3.85	2.04	1.89	5AS4	1.75	.93	.86	6AW8	1.30	1.69	1.57	6F6	2.65	1.50	1.30
1F4	2.85	1.51	1.40	5AS8	2.85	1.51	1.40	6AX4GT	2.35	1.24	1.15	6F6G	2.25	1.19	1.10
1F5G	2.85	1.51	1.40	5AT8	2.80	1.48	1.37	6AX5GT	2.25	1.19	1.10	6F7	4.25	2.24	2.08
1G5G	2.90	1.53	1.42	5AU4	2.90	1.53	1.42	6AX8	2.75	1.46	1.35	6F8G	3.85	2.04	1.89
1H4G	2.35	1.24	1.15	5AV8	3.00	1.59	1.47	6AZ8	3.35	1.77	1.64	6GG6	3.05	1.61	1.49
1H5GT	2.15	1.14	1.05	5AW4	2.75	1.46	1.35	6B4G	4.50	2.38	2.20	6H6	2.00	1.06	.98
1H6G	3.50	1.85	1.71	5AZ4	1.90	1.01	.93	6B7	3.50	1.85	1.71	6H6GT	2.30	1.22	1.13
1H6GT	3.50	1.85	1.71	5B8	3.00	1.59	1.47	6B8G	3.65	1.93	1.79	6J5	1.90	1.01	.93
1J6GT	3.50	1.85	1.71	5BE8	2.90	1.53	1.42	6BA6	1.80	.95	.88	6J5GT	1.90	1.01	.93
1L4	2.15	1.14	1.05	5BK7A	2.90	1.53	1.42	6BA7	2.95	1.56	1.44	6J6	2.35	1.24	1.15
1L6	2.90	1.53	1.42	5BR8	2.90	1.53	1.42	6BA8	3.25	1.69	1.57	6J7	2.55	1.40	1.30
1LA4	2.95	1.56	1.44	5J6	2.35	1.24	1.15	6BC4	2.10	2.17	2.01	6J7G	2.80	1.48	1.37
1LA6	2.20	1.16	1.08	5T4	5.00	2.65	2.45	6BC5	2.00	1.06	.98	6J8G	2.80	1.48	1.37
1LB4	3.10	1.64	1.52	5T8	2.90	1.53	1.42	6BC7	3.20	1.69	1.57	6K5GT	2.65	1.40	1.30
1LC5	2.90	1.53	1.42	5U4G	1.75	.93	.86	6BC8	3.45	1.83	1.69	6K6GT	1.90	1.01	.93
1LC6	3.25	1.72	1.59	5U4GB	1.75	.93	.86	6BD4A	20.45	9.75	9.15	6K7	2.55	1.35	1.25
1LD5	2.25	1.14	1.05	5U8	2.90	1.53	1.42	6BD6	1.60	.95	.88	6K7G	2.45	1.30	1.20
1LE3	3.90	2.04	1.89	5V4G	2.55	1.35	1.25	6BE6	1.90	1.01	.93	6K8	2.55	1.35	1.25
1LG5	2.90	1.53	1.42	5V4GA	2.55	1.35	1.25	6BF5	2.25	1.19	1.10	6L6	4.70	2.49	2.30
1LH4	2.90	1.53	1.42	5V6GT	1.90	1.01	.93	6BF6	1.60	.85	.78	6L6G	3.65	1.93	1.79
1LN5	2.90	1.53	1.42	5X4G	2.05	1.09	1.00	6BG6G	5.20	2.75	2.55	6L6GB	3.65	1.93	1.79
1NSGT	2.90	1.53	1.42	5X8	2.80	1.48	1.37	6BG6GA	5.20	2.75	2.55	6L7	3.15	1.67	1.54
1PSGT	2.90	1.53	1.42	5Y3G	1.45	.77	.71	6BH6	2.30	1.22	1.13	6L7G	3.40	1.80	1.66
1Q5GT	3.05	1.61	1.49	5Y3GT	1.45	.77	.71	6BH8	3.05	1.61	1.49	6N7	3.25	1.72	1.59
1R4	2.75	1.46	1.35	5Y4G	1.85	.98	.91	6B16	2.05	1.09	1.00	6N7GT	3.10	1.64	1.52
1R5	2.25	1.19	1.10	5Y4GT	1.85	.98	.91	6BK4	6.15	3.25	3.01	6P5GT	2.45	1.30	1.20
1S4	2.55	1.35	1.25	5Z3	2.35	1.24	1.15	6BK5	2.75	1.46	1.35	6Q7	2.65	1.40	1.30
1S5	1.90	1.01	.93	5Z4	3.60	1.91	1.76	6BK7A	2.90	1.53	1.42	6Q7G	2.10	1.11	1.03
1T4	2.15	1.14	1.05	6A3	4.10	2.17	2.01	6BL4	5.25	2.77	2.57	6Q8GT	2.30	1.22	1.13
1T5GT	2.80	1.48	1.37	6A5G	5.70	3.02	2.79	6BL7GT	3.45	1.83	1.69	6R7	2.80	1.48	1.37
1T6	2.50	1.32	1.23	6A7	3.05	1.61	1.49	6BN6	2.70	1.43	1.32	6R7GT	2.75	1.46	1.35
1U4	2.10	1.11	1.03	6A8	3.10	1.64	1.52	6BQ6GA	3.75	1.99	1.84	6S4A	1.75	.93	.86
1U5	1.85	.98	.91	6A8G	2.95	1.56	1.44	6BQ6GT	3.75	1.99	1.84	6S7	3.25	1.72	1.59
1U6	2.65	1.40	1.30	6AB8GT	2.90	1.53	1.42	6BQ8GT/A	3.75	1.99	1.84	6S7G	3.50	1.85	1.71
1V	2.55	1.35	1.25	6AB4	1.70	.90	.83	6BQ8GT/B	3.75	1.99	1.84	6S8GT	2.75	1.46	1.35
1V2	1.55	.82	.76	6AB5/6N5	2.85	1.51	1.40	6CU6	3.75	1.99	1.84	6SA7	2.30	1.22	1.13
1V6	3.70	1.96	1.81	6AB7/1853	3.55	1.88	1.74	6DQ7A	3.25	1.72	1.59	6SA7GT	2.30	1.22	1.13
1X2A	2.60	1.38	1.27	6AC5GT	3.10	1.64	1.52	6DR8	2.85	1.51	1.40	6SB7Y	4.45	1.83	1.69
1X2B	2.60	1.38	1.27	6AC7/1852	3.10	1.64	1.52	6BS8	3.25	1.72	1.59	6SC7	3.50	1.93	1.83
2A3	4.55	2.41	2.23	6AD7G	4.25	2.24	2.09	6BK7GT	3.35	1.77	1.64	6SD7GT	3.35	1.77	1.64
2A6	2.85	1.51	1.40	6AF4	3.40	1.80	1.66	6BV5GA	3.30	1.75	1.62	6SF5	2.05	1.09	1.00
2A7	2.85	1.51	1.40	6AF4A	3.40	1.80	1.66	6BY6	2.00	1.06	.98	6SF5GT	2.05	1.09	1.00
2AF4A	3.45	1.83	1.69	6AF6G	2.90	1.53	1.42	6BZ6	2.00	1.06	.98	6SF7	2.75	1.46	1.35
2B3	2.55	1.35	1.25	6AG5	2.05	1.09	1.00	6C4	1.50	.79	.73	6SG7	2.60	1.38	1.27
2B7	3.55	1.88	1.74	6AG7	3.65	1.93	1.79	6C5	2.20	1.16	1.08	6SH7	2.75	1.46	1.35
3A2	2.90	1.53	1.42	6AH4GT	2.45	1.30	1.20	6C5GT	2.15	1.14	1.05	6S17GT	2.15	1.14	1.05
3A3	2.90	1.53	1.42	6AH6	3.45	1.83	1.69	6C6	2.80	1.48	1.37	6SK7	2.15	1.14	1.05
3A8GT	5.00	2.65	2.45	6AH6V	3.95	2.12	1.94					6SK7GT	2.15	1.14	1.05
3AL5	1.60	.85	.78	6AJ4	4.45	2.35	2.18								
3AU6	1.90	1.01	.93	6AK5	4.20	2.22	2.06								
3AV6	1.55	.82	.76	6AK6	2.30	1.22	1.13								
3B2	4.45	2.35	2.18												

RECEIVING TUBES

TUBE TYPE	LIST PRICE	NET EACH IN LOTS OF 1 to 5	NET EACH IN LOTS OF 6 to 49	TUBE TYPE	LIST PRICE	NET EACH IN LOTS OF 1 to 5	NET EACH IN LOTS OF 6 to 49	TUBE TYPE	LIST PRICE	NET EACH IN LOTS OF 1 to 5	NET EACH IN LOTS OF 6 to 49	TUBE TYPE	LIST PRICE	NET EACH IN LOTS OF 1 to 5	NET EACH IN LOTS OF 6 to 49
12A5	1.65	.87	.87	12H6	2.20	1.16	1.08	1488	2.25	1.19	1.10	25CD6GB	4.95	2.62	2.42
12A05	1.95	1.03	.96	12I5	1.95	1.03	.96	14C5	3.00	1.59	1.47	25CU6	3.85	2.04	1.89
12A7	1.50	.79	.73	12I5GT	1.95	1.03	.96	14C7	2.50	1.32	1.23	25DN6	4.95	2.62	2.42
12A16	2.60	1.38	1.27	12I7GT	2.80	1.48	1.37	14E6	2.90	1.53	1.42	25DQ6	3.85	2.04	1.89
12A17	1.85	.98	.91	12K7GT	2.55	1.35	1.25	14F7	2.75	1.46	1.35	25L6	4.30	2.27	2.11
12A18	2.20	1.16	1.04	12K8	3.30	1.75	1.62	14F8	3.45	1.83	1.69	25L6GT	1.95	1.03	.96
12A19	2.20	1.16	1.04	12K8GT	2.95	1.56	1.44	14H7	2.50	1.32	1.23	25W4GT	2.10	1.11	1.03
12AV5GA	3.45	1.83	1.69	12L6GT	2.00	1.06	.98	14I7	3.65	1.93	1.79	25W6GT	2.60	1.38	1.27
12AV6	1.45	.77	.71	12Q7GT	2.30	1.22	1.13	14N7	2.65	1.40	1.30	25Z5	2.25	1.19	1.10
12AV7	3.05	1.61	1.49	12SA7	2.30	1.22	1.13	14Q7	2.75	1.46	1.35	25Z6GT	2.15	1.14	1.05
12AW6	2.45	1.30	1.20	12SA7GT	2.30	1.22	1.13	14R7	3.50	1.85	1.71	26	2.30	1.22	1.13
12AX4GTA	2.45	1.30	1.20	12SC7	2.50	1.32	1.23	14S7	3.25	1.72	1.59	27	2.15	1.14	1.05
12AX7	2.30	1.22	1.13	12SF5	2.15	1.14	1.05	14W7	3.35	1.77	1.64	31	2.85	1.51	1.40
12AZ7	2.60	1.38	1.27	12SF5GT	2.15	1.14	1.05	14X7	2.65	1.40	1.30	32	3.85	2.04	1.89
12B4A	2.30	1.22	1.14	12SF7	2.75	1.46	1.35	14Y4	2.40	1.27	1.18	32L7GT	3.35	1.77	1.64
12B6	1.60	.95	.88	12SF7GT	2.00	1.06	.98	19AU4GT	2.90	1.53	1.42	33	3.50	1.85	1.71
12B7	2.95	1.54	1.44	12SG7	2.60	1.38	1.27	19AU4GTA	2.90	1.53	1.42	34	3.65	1.93	1.79
12BD6	1.80	.95	.88	12SH7	2.75	1.46	1.35	19B6G6	6.00	3.17	2.94	35/51	2.40	1.27	1.18
12BE6	1.90	1.01	.93	12SJ7	2.15	1.14	1.05	19B6GA	6.00	3.17	2.94	35A5	2.55	1.35	1.23
12BF6	1.60	.85	.75	12SJ7GT	2.15	1.14	1.05	19C8	3.20	1.69	1.57	35B5	2.10	1.11	1.03
12BH7	2.55	1.35	1.25	12SK7	2.15	1.14	1.05	19E6	2.50	1.32	1.23	35C5	1.95	1.03	.96
12BK5	2.75	1.46	1.35	12SK7GT	2.15	1.14	1.05	19F8	2.90	1.53	1.42	35L6GT	1.95	1.03	.96
12B0GA	3.80	2.01	1.86	12SL7GT	2.80	1.48	1.37	19V8	3.55	1.88	1.74	35W4	1.25	.66	.61
12B0GTA	3.85	2.04	1.89	12SN7GT	2.25	1.19	1.10	19X8	3.10	1.64	1.52	35Y4	2.00	1.06	.98
12B0GTA	3.80	2.01	1.86	12SN7GTA	2.25	1.19	1.10	24A	2.75	1.46	1.35	35Z3	2.00	1.06	.98
12B7	2.25	1.19	1.10	12SQ7	1.90	1.01	.93	25A6	3.50	1.85	1.71	35Z4GT	1.55	.82	.76
12B7	2.25	1.19	1.10	12SQ7GT	1.90	1.01	.93	25A6G	2.75	1.46	1.35	35Z5GT	1.45	.77	.71
12B7	2.65	1.40	1.30	12SB7	2.15	1.14	1.05	25A5GA	3.35	1.77	1.64	36	2.90	1.53	1.42
12B7	2.65	1.40	1.30	12SB7GT	2.00	1.06	.98	25A5GT	3.35	1.77	1.64	37	1.85	.98	.91
12B7A	2.65	1.40	1.30	12V6GT	2.40	1.27	1.18	25AX4GT	2.75	1.46	1.35	38	2.35	1.24	1.15
12B7	2.55	1.35	1.25	12X4	1.40	.74	.69	25B5K5	2.85	1.51	1.40	39/44	2.85	1.51	1.40
12C5	1.95	1.03	.96	12Z3	2.60	1.38	1.27	25B06GA/	3.85	2.04	1.89	40A1	2.15	1.14	1.05
12C8	3.95	2.09	1.94	14A4	2.65	1.40	1.30	25CU6	3.85	2.04	1.89	40B2	2.15	1.14	1.05
12CA5	2.05	1.09	1.00	14A5	3.90	2.06	1.91	25B06GT	3.85	2.04	1.89	41	2.30	1.22	1.13
12CR6	1.90	1.01	.93	14A7/12B7	2.25	1.19	1.10	25B0GTB	3.85	2.04	1.89	42	2.15	1.14	1.05
12CU6	3.85	2.04	1.89	14AF7/				25C5	1.95	1.03	.96	43	2.30	1.22	1.13
12DQ6	3.80	2.01	1.86	XXD	2.75	1.46	1.35	25CA5	2.20	1.16	1.08	45	2.15	1.14	1.05
12FSGT	2.40	1.27	1.18	14B6	2.35	1.24	1.15	25CD6GA	4.95	2.62	2.42	45Z3	1.80	.95	.88

T.V. PICTURE TUBES

At A New Low Price!

BRAND NEW Not rebuilt or rejuvenated.
ORIGINAL SEALED TUBE MANUFACTURERS' CARTONS
 Not repacked, but in original sealed cartons of the tube manufacturer.
GUARANTEED FOR 1 YEAR

RETURN YOUR OLD PICTURE TUBE AND SAVE MONEY

Your old picture tube "DUD" is worth money. Many types are returnable for an allowance as shown in the chart below. Please note that the tube must be free from mechanical defects such as broken, scorred or punctured glass and must be of the exact type number. Thus a 12LP4 is not acceptable for a 12LP4A. Tubes must be returned prepaid.

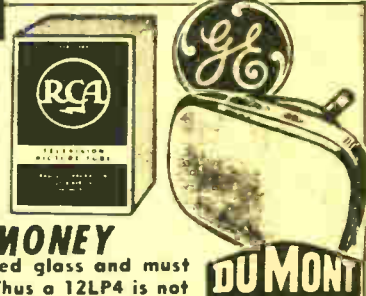

Type No.	List Price	Net With DUD	Net Less DUD	Type No.	List Price	Net With DUD	Net Less DUD	Type No.	List Price	Net With DUD	Net Less DUD	Type No.	List Price	Net With DUD	Net Less DUD
STP4	78.25	—	58.65	16ZP4	43.00	29.10	32.35	20JP4	44.75	29.00	33.50	21ZP4A	39.00	24.70	29.20
7DP4	39.75	—	29.75	17AP4	31.25	20.25	23.50	20MP4	57.75	38.75	43.25	21ZP4B	44.25	28.70	33.20
7JP4	27.75	—	20.80	17AVP4	34.00	22.10	25.35	21ACP4/MP4	41.50	23.20	27.70	24AP4	120.00	—	90.00
8AP4	27.75	—	19.40	17AVP4A	39.00	26.00	29.25	21ACP4A/MP4A	46.00	28.70	33.20	24CP4A	64.50	42.50	48.50
10BP4A	20.75	14.50	15.50	17B4A	32.00	20.75	24.00	21ACP4A	44.25	28.70	33.20	24DP4A	66.50	44.00	50.00
10FP4A	25.40	17.15	18.15	17BP4B	37.50	24.75	28.00	21ALP4	43.00	24.50	29.00	24VP4A	64.50	42.00	48.00
10HP4	35.00	—	26.50	17CP4	40.00	27.50	30.00	21ALP4A	46.00	30.00	34.50	24YP4	66.50	44.00	50.00
10MP4	27.50	—	20.65	17FP4A	37.25	22.80	26.05	21ALP4B	46.00	30.00	34.50	27EP4	117.00	—	88.00
12EP4A	21.25	27.25	29.75	17GP4	44.75	30.85	33.35	21AMP4A	44.25	28.70	33.20	27MP4	152.50	—	114.40
12LP4A	25.25	16.50	19.00	17HP4/RP4	34.00	22.10	25.35	21AP4	47.00	32.70	35.20	27RP4	117.00	—	88.00
12QP4A	Replaced by Type B1034			17HP4B	39.00	26.00	29.25	21ARP4	52.40	32.15	36.65				
B1034	33.50	22.75	25.25	17JP4	34.00	22.10	25.35	21ARP4A	58.70	36.55	41.05				
12UP4A	42.75	—	32.00	17KP4	35.75	23.50	26.75	21ATP4	46.00	30.00	34.50				
12UP4B	42.75	30.00	32.00	17LP4/VP4	34.00	22.10	25.35	21ATP4/TP4A	46.00	30.00	34.50				
12VP4A	32.00	21.50	24.00	17LP4A	39.00	26.00	29.25	21AUP4/VP4	40.75	26.05	30.55				
14BP4	27.50	19.65	20.65	17QP4	32.00	20.75	24.00	21AUP4A/VP4A	46.00	30.00	34.50				
14CP4	27.50	19.65	20.65	17QP4A	37.50	24.75	28.00	21AUP4A	46.00	30.00	34.50				
14CP4/EP4	27.50	19.65	20.65	17RP4/HP4	34.00	22.10	25.35	21AUP4A/UP4B	46.00	30.00	34.50				
14HP4	27.75	19.65	20.65	17TP4	40.00	27.50	30.00	21AVP4A	46.00	30.00	34.50				
14QP4	29.30	21.00	22.00	17VP4/LP4	34.00	22.10	25.35	21AVP4A/VP4B	44.25	28.70	33.20				
14QP4A	34.65	25.00	26.00	17YP4	32.00	20.75	24.00	21AWP4	46.00	30.00	34.50				
15DP4A	Replaced by Type B1014			19AP4A	48.75	34.00	36.50	21AXP2Z	175.00	—	145.00				
B1014	37.75	25.75	28.25	19AP4B	48.75	34.00	36.50	21BAP4	46.00	28.50	33.00				
15GP22	265.00	—	235.00	20CP4	39.00	24.70	29.20	21EP4	40.75	27.00	30.50				
16AP4	44.75	30.85	33.35	20CP4A	39.00	24.70	29.20	21EP4A	40.75	27.00	30.50				
16DP4A	44.75	30.10	33.35	20CP4B	44.25	28.70	33.20	21EP4B	46.00	31.00	34.50				
16EP4A	53.00	—	40.00	20CP4D	44.25	28.70	33.20	21FP4	42.25	28.25	31.75				
16FP4	35.75	24.25	26.75	20DP4	39.00	24.70	29.20	21FP4A	42.25	28.25	31.75				
16GP4	44.75	31.00	33.50	20DP4A	39.00	24.70	29.20	21FP4C	47.75	32.25	35.75				
16GP4B	44.75	30.85	33.35	20DP4A/CP4A	39.00	24.70	29.20	21KP4	54.75	37.50	41.00				
16JP4A	43.00	—	32.35	20DP4B	44.25	28.70	33.20	21MP4	48.75	34.00	36.50				
16KP4	32.00	20.75	24.00	20DP4C	44.25	28.70	33.20	21WP4	39.00	24.70	29.20				
16KP4A	36.75	24.25	27.50	20DP4C/CP4D	44.25	28.70	33.20	21WP4A	47.00	24.70	33.20				
16LP4A	43.00	29.10	32.35	20HP4	42.75	26.00	30.50	21XP4	40.75	26.00	30.50				
16RP4/EP4	32.00	20.75	24.00	20HP4A/LP4	42.75	26.00	30.50	21XP4A	48.50	30.00	34.50				
16RP4A/EP4A	36.75	24.75	28.00	20HP4A/MP4	42.75	26.00	30.50	21YP4	39.00	24.70	29.20				
16TP4	32.00	20.75	24.00	20HP4C	47.50	30.00	34.50	21YP4A	46.00	30.00	34.50				
16WP4A	43.00	29.10	32.35	20HP4D	47.50	30.00	34.50	21ZP4	39.00	24.70	29.20				

T.V. TEST TUBE



The same tube used by manufacturers to check TV chassis. It's handy. You can check reception while making adjustments without removing the picture tube. Plugs right into any TV chassis or you can put it in a separate box with a jumper harness. It's quick. Has automatic self-focusing, works with either electrostatic or magnetic designs. Magnetically deflected, works with yokes from 52° to 90°. It's safe, requires no ion traps, has no external conductive coating, easily grounded. Eliminates handling of the picture tube. Only 10 3/4" long x 5" diam.
SYLVANIA 5AXP4 Net 22.0

BATTERY CHARGERS · CONVERTERS · ELIMINATORS

"B" BATTERY ELIMINATOR AND CHARGER FOR PORTABLE RADIOS



2.95

- REPLACES ALL 67½ VOLT "B" BATTERIES
- REJUVENATES YOUR "B" BATTERY
- SAVES YOUR BATTERY — SAVES YOUR MONEY

Conserve your expensive "B" battery with this new device. While indoors you need not use your "B" battery at all. This eliminator takes its place operating your portable set directly from your regular 110V AC house current. It's small, fits in place of your battery. Simply replace battery with eliminator and plug in to house current. When taking the set outdoors, you can replace the battery in a few seconds. But that's not all! The unit has another set of snap terminals on the reverse side to rejuvenate your battery. By connecting your "B" battery to these terminals and plugging it into your 110V AC line overnight, you will get many extra hours of use out of the battery. Will replace all snap-terminal 67½ Volt "B" batteries. Size: 1½" x 2½" x 1¾". Complete with 6" AC line cord and plug. Shpg. wt., 1½ lbs.

F-195 Net 2.95

SCHAUER BATTERY CHARGERS

4 AMP CHARGERS

Here is a small, highly efficient unit that will recharge most batteries overnight. The 4 ampere charging rate tapers to approximately 2 amps as the battery becomes fully charged. Equipped with special "Charger-Guard" which provides instantaneous and full automatic protection against short circuits and overloads. No manual resetting of a circuit breaker or replacing of blown-out fuses. Selenium rectifier and quality construction. Quickly connected without disconnecting or removing the battery from your car. Operates on regular 110-115 volt 60 cycle AC house current. Steel case is 4½" x 4½" x 6¼". Complete with cables. Shpg. wt. 6V model 4½ lbs., 12V model 6 lbs.



Model AX-2

Model AX-2—for 6 volt batteries Net 9.30
Model AX2-12—for 12 volt batteries Net 11.97

6 AMP CHARGERS

Heavier 6 ampere charger that will completely charge the average run-down battery in 7 to 9 hours without disconnecting or removing it from the car. Has the same protective "Charger-Guard" feature as the AX-2. Equipped with an accurate numerical dial ammeter that shows the exact charging rate going into the battery. Steel case size 6¼" x 6" x 7¼". Complete with cords and battery clips. Operates on 110-115 volt 60 cycle AC. Shpg. wt. 6V model 8 lbs., 12V model 10 lbs.



Model BX-2

Model BX-2—for 6 volt batteries Net 13.30
Model BX2-12—for 12 volt batteries Net 16.63

10 AMP CHARGERS

Extra heavy duty. Recharges the average battery in 6 hours or less. Ideal for heavy duty batteries used in passenger cars, trucks, farm vehicles, etc. Charges at a safe rate which automatically tapers to a finishing charge. Has the "Charger-Guard" feature for protection against shorts and overloads. Accurate numerical dial ammeter shows charging rate. Complete with cords and clips. Steel case size 6½" x 6" x 7¼". Operates on 110-115 volt 60 cycles AC. Shpg. wt. 6 volt 10 lbs., 12 volt 12 lbs.



Model CX-2

Model CX-2—for 6 volt batteries Net 17.30
Model CX2-12—for 12 volt or two 6 volt batteries Net 21.97

20 AMP QUICK CHARGER WITH TRICKLE CHARGER FEATURE

A quick charger which makes it possible within a few minutes to start a car with a run down battery and which can deliver a full charge within 1½ to 2½ hours. Charges the battery of a 20 ampere rate which tapers down as the battery becomes charged. The exact charging rate is indicated by an accurate numerical dial ammeter. This model is also equipped with a trickle charge which can be used to keep the battery fresh after it has been charged. As many as 60 new storage batteries can be trickle charged to maintain full charge. This charger may also be used to charge as many as 4 batteries overnight at a 5 ampere rate. Complete with cables. Size: 7½" x 10½" x 9½". Shpg. wt., 6V model 15 lbs., 12V model 22 lbs.



Model FX-3 for 6 volt batteries Net 31.97
Model FX-3-12 for 12 volt batteries Net 41.30

CHARGER PLUG

For use with all Schauer chargers. Eliminates need of attaching charger leads to battery. Charger connected simply by plugging into car's cigarette lighter receptacle. Fits all cars. Shpg. wt. ½ lb.



Model A8410

Model A-8410 6 volt charger plug Net 1.17
Model A-8412 12 volt charger plug Net 1.17

TERADO DC to AC CONVERTERS



TERADO
TRAV-ELECTRIC
SUPER
CONVERTER

Model 6-71160. New miniature converter delivers 60 watts AC from your car cigarette lighter! Husky enough for small motors—run electric drills, vacuum cleaners, electric shavers in your car! Perfect for salesmen, sportsmen and vacationers. Will operate phonographs, radios, tape recorders, dictating machines. Campers use to light 110 volt fluorescent lamps. Servicemen use to operate test equipment—antenna rotators in field tests. Converts 6 volts DC from your car battery to 110 volts AC, 60 cycles. 75 watts intermittent, 60 watts continuous. Wt. 8 lbs. Size 3¼x3¼x6"
List 42.95 25.25
NET 25.25

Type 12-71160. As above, but for 12 volts. List, 42.95 NET 25.25

KAR-SHAVER CONVERTER

For shaving in car, boat, etc. Plug into cigarette lighter outlet. Converts the 6 V DC from your car battery to 110 V AC. Use with any electric razor.
MODEL 6-11160, 15 watts, NET 7.03
MODEL 12-11160, (12 V), 15 watts, NET 7.03



TRAV-ELECTRIC
SENIOR
CONVERTER

Model 6-1160. Small enough to hold in your hand! Delivers 110V AC from your 6 volt DC car battery. Just plug into cigarette lighter. Maximum capacity 40-45 watts. Battery drain is only 4½ amps when used with a table model radio! Use in cabin or trailer—on picnics and outings—in boats and trucks. Will operate radios, electric shavers, phonographs, small dictating machines and trouble lights. Ideal for vacationers, salesmen, servicemen, professional men. Fully filtered. Ready to operate. No installation—just plug in. Shpg. wt. 3¼ lbs. Size 2½x2½x4"
List 19.95 11.93
NET 11.93

Type 12-1160. As above, but for 12 volts. List, 19.95 NET 11.93

TRAV-ELECTRIC JR. CONVERTER

Model 6-110. Changes 6 volts DC to 110V AC, 115 cycles, 40 watts maximum capacity. Will operate small radios or lamp in car, boat, cabin or trailer, or on picnics, outings, etc. Plug into car cigarette lighter. Fully filtered. Ready to operate. Shpg. wt. 3¼ lbs. Size 2½x2½x4"
List 14.95 NET 8.79
Type 12-110. As above, but for 12 volts. List, 14.95 NET 8.79

WILLARD RECHARGEABLE BATTERIES



Polystyrene cased compact, rechargeable wet batteries for 2 volt power supplies providing the portability of dry cells and long life of storage batteries. Non-spill construction utilizing fibrite insulation which also prevents plate shedding. Built-in charge indicator. Can be series connected for higher voltages. Shipped wet, express only.

Type 25-2 Portable Rodia Battery. Rated at 2 volts for 21 ampere-hours. Original equipment in G.E. models 250 and 260. 9 plates. Size: 2-17/32" x 2-31/32" x 6". Shpg. wt., 3½ lbs.

Willard 25-2 List 11.15 Net 11.15

Type ER-6-2B Photo-Flash Battery. Rated at 2 volts for nearly 6 ampere-hours. 125 to 250 flashes before recharging. Provides the high amperage needed for positive bulb flash and split-second synchronization of solenoid shutter and bulb. Size: 1-11/16" x 2¾" x 4¼". Shpg. wt., 1½ lbs.

Willard ER-6-2B List 7.55 Net 5.28

Type ER-34-2 Portable Radio Battery. Rated at 2 Volts for 34 ampere-hours. Original equipment in RCA 65BR9 portable radio, 17 plates. Size: 4½" x 3-11/16" x 4½". Shpg. wt., 5½ lbs.

Willard ER-34-2 List 14.85 Net 10.39

BIG BEAM

Sealed Beam Beacon Lamp

Powerful and versatile portable hand lamp. Operates as a lamp, a flashing red beacon, or both. The flashing beacon may be positioned up or down. Sealed beam bulb keeps mirrored reflector dust free. 4" chrome-plated steel lamphead. Chrome-plated beacon arm fits snugly over handle. Beacon flashes 60 times per minute. Steel weather-proof case with hinged cover and snap catch. Operates on one battery. Shpg. Wt. 3 lbs. List 10.50.

ML-66—Less Battery Net 6.98

Burgess No. F4H battery Net 61c
Wt. 1½ lbs.



6.98

BATTERIES TRANSISTOR, HEARING AID, PORTABLE, SUN

NEW! RCA TRANSISTOR BATTERIES



New RCA miniature batteries specially designed and constructed for Transistor and subminiature applications. Unusually high operating and shelf life. Rugged and dependable. All have 2-Snap Fasteners except VS400 has flashlight terminals and VS301 has 4-hole socket.

Type	Volts	Size L x W x H (in.)	SHPG. WT.	NET EACH
VS311	4.0	1.2 x 1	1 Oz.	.57
VS308	4.0	1.5 x 1.6 x 1-1/8	3 Oz.	.67
VS400	4.0	1-1/2 x 1-31/32	6 Oz.	1.12
VS310	6.0	1.2 x 1-1/4	1 Oz.	.70
VS307	6.0	1.5 x 1.6 x 1-1/4	3 Oz.	.77
VS300	9.0	31/32 x 1-21/32	5 Oz.	.94
VS301	9.0	1.2 x 1-7/8	2 Oz.	.84
VS309	9.0	1 1/8 x 1-9/16 x 2-11/16	3 Lb.	1.05

TRANSISTOR BATTERY HOLDERS

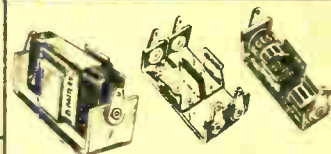

These Battery Holders were especially designed for use in transistor and sub-miniature electronic gear, are made of Aluminum Alloy, sturdy construction with insulated, nickel plated Brass eyelets for easy soldering.

STOCK NO.	DESCRIPTION	NET
MS-137	For 1 #7 Cell	.18
MS-138	For 2 #7 Cells	.37
MS-139	For 3 #7 Cells	.44
MS-160	For 2 #2 Cells	.20
MS-170	For 1 #2 Cell	.10
MS-171	For 4 #2 Cells	.57
MS-172	For 1 #1 Cell	.20
MS-173	For 2 #1 Cells	.37
MS-174	For 1 #2 Cell	.20
MS-175	For 2 #2 Cells	.37
MS-176	For 2 #2 Cells	.37
MS-177	For U15 22 1/2 V Cell	.20
MS-178	For 2 U15 22 1/2 V Cells	.37
MS-179	For 2 Mallory RM 502R	.26
MS-180	For 4 Mallory RM 502R	.39
MS-181	For 2 Mallory RM 12R	.26
MS-182	For 4 Mallory RM 12R	.39
MS-183	For 1 #413 30 volt Cell	.24
MS-184	For 2 #413 30 volt Cells	.39
MS-225	For #Y-10 Cell	.25

BURGESS TRANSISTOR AND HEARING AID BATTERIES



BURGESS REPLACES	VOLTS	SIZE L x W x H (in.)	SHPG. WT.	NET EACH
N	VS074	1-11/64 x 7-1/16 diam.	1 oz.	.08
404	ER274	2-17/32 x 2-7/8 diam.	3 lb.	2.69
ZN6	ER276	1-3/8 x 1-3/8 x 1-1/2	1 lb.	1.19
D6	ER276	1-9/32 x 29/32 x 2-7/32	1 1/2 lbs.	1.42
ZU6	ER216	1 x .39 64 x 1 7/8	3 Oz.	1.05
X9	ER239	1-3/32 x 29/32 x 2-7/32	4 oz.	.86
K10	VS083	1 1/8 x 8 x 1-1/2	2 oz.	1.05
Y10	VS083	1 x .39 64 x 1-7/8	2 oz.	.77
K15	ER501E	19/32 x 19/32 x 1-21/64	2 oz.	.77
U15	VS084	1 x .39 64 x 1-31/32	2 oz.	.98
K20	ER505E	19/32 x 19/32 x 1-31/32	2 oz.	.98
U20	VS085	1 x .39 64 x 2-17/32	2 oz.	1.37
Y20	ER506E	1-3/16 x 19/32 x 1-13/32	2 oz.	1.23
Z20s	VS087	19/32 x 19/32 x 2-9/16	2 oz.	1.32
	VS088	3/8 x 17/32 diam.	6 oz.	2.06
		5/16 x 15/16 diam.		

MALLORY MERCURY TRANSISTOR POWER-PAKS



TYPE	VOLTS	CAP. MAH.	SIZE H x Diam. (in.)	MAX DRAIN MA	STD. PKG.	SIN. GLY.	NET EACH
TR-140R	1.4	1600	.980 x .505 x 1.227	200	2	1.23	1.12
TR-152R	2.5	1000	1.125 x .480	10	2	.77	.70
TR-162R	2.5	1000	.875 x .655	50	2	.83	.78
TR-120R	2.5	800	1.080 x .569 x 1.227	100	2	1.19	1.00
TR-132R	2.5	1000	1.105 x .655	160	2	.88	.80
TR-113R	4.0	800	1.148 x .655	20	2	.99	.90
TR-153R	4.0	1000	1.657 x .880	50	2	1.16	1.05
TR-163R	4.0	500	1.450 x .655	50	2	1.16	1.05
TR-133R	4.0	1000	1.050 x .655	100	2	1.23	1.12
TR-123R	4.0	2200	1.069 x 1.015	100	2	1.48	1.68
TR-114R	5.0	250	1.660 x .650	20	2	1.29	1.12
TR-164R	5.0	500	1.789 x .655	50	2	1.45	1.32
TR-135R	6.5	1000	1.225 x .650	100	2	1.63	1.48
TR-115R	6.5	250	1.295 x .650	20	1	1.63	1.48
TR-165R	6.5	500	1.285 x .655	50	2	1.76	1.60
TR-136R	8.0	1000	1.306 x .655	100	2	1.98	1.80
TR-146R	9.0	400	1 x .531 x 1.938	40	2	1.65	1.68
TR-145R	9.0	300	1.185 x .640	20	2	1.49	1.35

MALLORY MERCURY "A" and "B" BATTERIES

New standard size Mallory "A" and "B" Batteries for hearing aids, miniature radios and experimenter's packs. Provide 2 to 3 times the service and shelf-life of ordinary types at lower operating costs. Manufactured by high temperatures. All have button contacts except "A" have tabs. Average shpg. wt. 2 1/2 oz.

"A" BATTERIES

TYPE	VOLTS	CAP. MAH.	SIZE DIAM. H x F (in.)	MAX DRAIN MA	STD. PKG.	SIN. GLY.	NET EACH
RM-1R	1.345	1,000	.628 x .650	100	4	.59	.45
RM-3R	1.345	2,200	.980 x .650	60	4	.72	.65
RM-4R	1.345	4,100	1.198 x .650	80	4	.77	.65
RM-4RT*	1.345	4,100	1.198 x .650	80	4	.72	.65
RM-12R	1.345	2,400	1.198 x .650	80	4	.77	.65
RM-12R	1.345	3,600	.628 x 1.980	250	2	.83	.75
RM-42R	1.345	41,000	1.198 x 2.775	1000	1	1.70	1.70
RM-42RT*	1.345	11,000	1.198 x 2.775	1000	1	1.75	1.75
RM-400R	1.345	80	.458 x .125	10	5	.29	.26
RM-401R	1.345	800	.15 x 1.10	100	2	.39	.35
RM-450R	1.345	1,000	.438 x .560	10	4	.31	.28
RM-502R	1.345	2,400	.538 x 1.030	200	2	.62	.58
RM-601R	1.345	1,800	.628 x 1.125	150	2	.56	.51
RM-625R	1.345	250	.613 x .258	20	4	.30	.27
RM-625RT*	1.345	250	.613 x .258	20	4	.35	.32
RM-630R	1.345	450	.619 x .263	20	4	.26	.24
RM-640R	1.345	500	.629 x .430	50	4	.33	.30

"B" BATTERIES

RM-411R	15	130	1 x 17/32	10	1	.95	.95
RM-412R	25	130	1 x 17/32	10	1	1.25	1.25
RM-413R	30	130	1 x 17/32	10	1	1.43	1.43
RM-415R	45	130	1 x 17/32	10	1	2.20	2.20

INTERNATIONAL SELENIUM SUN BATTERIES

CONVERT NATURAL OR ARTIFICIAL LIGHT TO ELECTRICAL POWER ECONOMICALLY!

The International Sun Battery supplies electrical power to a load when exposed to sunlight or artificial light sources, and is specially processed for high illumination level and high current density operation. Mounted on bracket with 5/16" color coded pigtail leads attached. Impregnated for protection against humidity and atmospheric contaminants. The SB sun batteries are sealed in a phenolic case with plastic window, and mount by four holes in the frame.

TYPICAL OUTPUT POWER FOR OPTIMUM MATCH TO LOAD

OVERALL DIMENSIONS INCH BY INCH	2000 foot candles	5000 foot candles	10,000 foot candles	NET				
	Volts	MA	Volts MA	Volts MA				
1B2PLB	0.72 x 0.41	0.21	1.0	0.25	2.0	0.26	3.5	2.10
1B5PLB	1.14 x 0.64	0.21	3.0	0.75	6.0	0.26	17.0	4.00
1B10PLB	1.69 x 0.88	0.21	5.0	1.25	10.0	0.26	30.0	7.00
1B15PLB	1.93 x 1.09	0.21	9.0	2.25	18.0	0.26	47.0	10.00
1B20PLB	2.0 x 2.29	0.21	12.0	3.0	24.0	0.26	60.0	13.00
1B30PLB	3.22 x 3.25	0.21	32.0	8.0	60.0	0.26	100.0	23.00
SB-16B10	4.8 x 8.1	1.0	5.0	4.0	10.0	4.0	18.0	80.00
SB-8B15	4.8 x 8.1	1.0	8.0	2.0	18.0	2.0	30.0	75.00

B-15 PHOTOCELL - 750 U average output at 100 ft. candles illumination and 100 ohm external resistance. 1-11/16" x 1-11/16". Unmounted. Net 5.88

RCA and BURGESS PORTABLE BATTERIES



PORTABLE "A" & "B" COMBINATION PACKS
When ordering "A" & "B" packs, deduct 5% in lots of 3, assorted

BURGESS TYPE	RCA TYPE	VOLTS	SIZE L x W x H (in.)	SHPG. WT. LBS.	NET EACH
2TXK40	VS166	1.5	2-3/8 x 2 1/8 x 1 1/2 x 7/8	2	3.38
4TZ60	VS66	1.5	2-5/8 x 2 1/8 x 1 1/2 x 7/8	4	3.85
6TA60	VS86	1.5	2-7/8 x 2 1/8 x 1 1/2 x 7/8	6	4.36
17D60	VS122	1.5	1-1/2 x 1 1/2 x 1 1/2	2 1/2	6.71
TB250	VS650	6.75	8-1/2 x 2 1/2 x 1 1/2	4 1/2	4.17
TS20P	VS660	6.75	8-1/2 x 2 1/2 x 1 1/2	4 1/2	4.17
FGA60	VS619	7.2	8-1/2 x 2 1/2 x 1 1/2	4 1/2	4.80
G6M60	VS618	7.2	8-1/2 x 2 1/2 x 1 1/2	4 1/2	5.25
TG280	VS67W	7.2	8-1/2 x 2 1/2 x 1 1/2	4 1/2	4.55
FGA90	VS658	7.2	8-1/2 x 2 1/2 x 1 1/2	4 1/2	4.55
G6B60	VS647	9.0	13-29/32 x 2 1/8 x 1 1/2	8	4.55
TG260	VS659	9.0	8-1/2 x 2 1/2 x 1 1/2	4 1/2	4.55

PORTABLE "A" BATTERIES

BURGESS TYPE	RCA TYPE	VOLTS	SIZE L x W x H (in.)	SHPG. WT. LBS.	NET EACH
1D	VS435	1.5	1-15/16 x 6 3/4 diam.	4 oz.	.10
D3	VS076	1.5	2-9/16 x 1-9/16 x 3/4	1	.53
2F	VS141	1.5	2-19/32 x 1-3/8 x 1-1/4	1 1/4	.52
Z	VS036	1.5	2-2/8 x 1-21/64 diam.	5 oz.	.10
3R	VS070	1.5	2-3/8 x 2-5/8 x 3/4	2	.89
Z1R	VS236	1.5	3-15/16 x 1-3/4 diam.	8 oz.	.35
8R		1.5	4-1/8 x 1-3/8 diam.	1	.57
37		1.5	4-1/8 x 1-3/8 diam.	1	.25
F3	VS034	1.5	1-31/32 x 25/64 diam.	4 oz.	.08
D3	VS072	1.5	3-7/8 x 1-5/8 x 1-5/16	1 1/4	.60
Z3	VS067	1.5	4-1/7 x 1-3/8 x 1-1/8	1 1/4	.60
G3	VS082	1.5	4-1/8 x 1-7/8 x 1-1/8	2	.74
F4P1	VS009	6	2-21/32 x 2-21/32 x 4-1/4	2 1/2	.88
Z1R	VS668	6	1-3/4 x 1-3/8 x 1-3/8	2 1/2	.88
C5	VS129	7.2	3-29/32 x 7/8 x 2-7/32	1 1/4	.88
B5	VS065	7.2	2-7/32 x 1-15/16 x 1-1/2	1 1/4	.88
T5		7.2	2-17/32 x 2-19/32 x 2-9/32	2	.96

PORTABLE "B" BATTERIES

BURGESS TYPE	RCA TYPE	VOLTS	SIZE L x W x H (in.)	SHPG. WT. LBS.	NET EACH
A15	VS014	22 1/2	1 x 3/8 x 1-31/32	4 oz.	.98
U30	VS016	45	3-9/16 x 2-1/8 x 5-1/16	2 1/2	1.75
B30	VS017	45	2-1/8 x 2-1/8 x 5-1/16	3 1/4	2.70
M30	VS013	45	3-9/16 x 1-3/8 x 5-1/16	2 1/2	1.75
X30	VS086	45	1-3/4 x 2-1/8 x 3/4	1 1/4	1.88
VS055		45	2-1/8 x 2-1/8 x 3/4	1 1/4	1.88
Z30	VS033	45	3-22/64 x 1-1/8	2 1/2	2.53
K30	VS082	67 1/2	2-11/16 x 1-5/16 x 2-1/4	1	2.07
P45	VS218	67 1/2	1-29/32 x 1-3/8 x 9/32	1 1/4	2.00
VS016		67 1/2	1-29/32 x 1-3/8 x 9/32	1 1/4	2.00
XX45	VS016	67 1/2	3-23/64 x 1-3/8 x 3/4	1 1/4	2.28
XX50	VS217	67 1/2	1-27/32 x 1-5/16 x 5-1/16	1 1/4	2.77
NG0	VS008	90	1-11/8 x 1-9/32 x 3-19/32	2	2.77
N60	VS219	90	1-29/32 x 1-7/8 x 3-19/32	2 3/4	4.45
XX69		104 1/2	1-11/32 x 1-11/32 x 1-23/32	2	3.60
U200	VS093	300	2-1/3 x 2-9/32 x 3-7/8	2	7.70

FLASHLIGHT AND LANTERN BATTERIES

BURGESS TYPE	RCA TYPE	VOLTS	SIZE L x W x H (in.)	SHPG. WT. LBS.	NET EACH
1	VS035	1.5	1-15/16 x 6 3/4 diam.	3 oz.	.10
2	VS036	1.5	2-3/8 x 1-21/64 diam.	5 oz.	.10
6	VS006S	1.5	6 x 2-1/2 diam.	2 1/2	.65
Z	VS074	1.5	1-3/4 x 1 3/8 diam.	1 oz.	.08
N	VS073	1.5	1-11/8 x 6 7/16 diam.	1 oz.	.07
Z	VS034	1.5	1-31/32 x 25/64 diam.	2 oz.	.08
4F2H	VS138	3	3-29/32 x 2-1/8 x 1-1/8 x 3/4	3 1/2	1.25
4F4H	VS040C	6	2-1/4 x 2-5/8 x 3-15/16	2 1/2	.61
4F5H	VS039	6	8-5/16 x 2-1/8 x 1-3/8 x 1-1/8	7 1/4	2.63
4F6H	VS139	7 1/2	7-3/		

RECORD PLAYERS PHONO SPECIALTIES



BEST BUY
3-SPEED
PORTABLE PHONO

15.95

With this portable phonograph you can play any record up to 12" size at 33 1/3, 45 or 78 r.p.m. A simple slide switch selects the proper speed. The light weight pickup arm is equipped with an all-groove needle—one needle for all records. The phonograph amplifier has a selenium rectifier and

drives a fine Alnico V speaker. The volume control is equipped with an on/off switch—the entire unit designed to provide shock proof operation. Attractive 2-tone case. For 110 Volts 60 cycles only. Size: 12 1/2" x 10 1/4" x 5 1/4". Shpg. Wt. 10 lbs.

PH-26—3-speed portable phono **NET 15.95**

THE LAFAYETTE STAR

- With G.E. Variable Reluctance High Fidelity Cartridge!
- Dual Sapphire Styli!
- 6" x 9" Alnico V Wide Range Heavy Duty PM Speaker

UNBELIEVABLE QUALITY AT AN UNHEARD OF PRICE

This new deluxe 3-speed phono incorporates the famous G.E. RPX-050A triple-play cartridge with frequency response to 10,000 cycles in a special lightweight arm. The G.E. magnetic cartridge has two sapphire needles to play standard and LP records with remarkable fidelity. Built-in preamplifier for G.E. magnetic cartridge. Large size 6 1/2" oval PM speaker, amply baffled in a large size chamber to give clean undistorted output. Size: 14" x 9" x 16". Finished in Mahogany or Oak wood grain leatherette with gold grilles. Shpg. wt., 16 lbs. PH-25 **Net 35.45**



PLAYS ALL SPEEDS ALL SIZES

\$35.45

PROTECT YOUR RECORDS WITH PLASTIC COVERS



YOUR COST PER PACKAGE

1.49

Soft pliable plastic covers to protect records from dirt, dust and moisture. Available in square beaded bottom to fit 7", 10" and 12" records in jackets and in round beaded bottom to cover 10" and 12" records without jackets. Shpg. wt., 1/2 lb.

- PK-117 — Package of 30 12" Square Jacket Covers
 - PK-118 — Package of 40 10" Square Jacket Covers
 - PK-119 — Package of 50 7" Square Jacket Covers
 - PK-120 — Package of 30 12" Round Record Covers
 - PK-121 — Package of 40 10" Round Record Covers
- NET 1.49**

PORTABLE AUTOMATIC 45 RPM RECORD CHANGER - PLAYER

- Plays a Stack of 14 45 RPM Records Automatically.
- Completely Self Contained - No Need to Connect to Radio

An attractively styled portable phonograph for all types of 45 RPM records. Self contained powerful amplifier and Alnico V speaker. Automatically changes records; plays a full stack of 14 for up to 2 hours of continuous music. Has full range volume control. Wood case, with lock corner construction, is covered in wood grained leatherette. Truly portable, only 8 1/4" x 7 1/4" x 11 1/4". Shpg. Wt. 9 lbs.

PH-42 **NET 24.95**



Learn To Speak

FAMOUS LIVING LANGUAGE COURSE

FRENCH, ITALIAN, SPANISH OR GERMAN

now only

9.95

- 40 LESSONS RECORDED ON 4 LP RECORDS
- CONVERSATION MANUAL REPEATS LESSONS IN PRINT
- COMMON USAGE DICTIONARY OF OVER 16000 ITEMS

Thousands of these famous language courses were sold at \$29.95. By mass producing the course on only 33-1/3 LP records instead of twenty 78 RPM records the price has been reduced to only 1/3 the original price.

4 LONG-PLAYING RECORDS

The entire course of instruction (40 complete lessons) is contained in these four long-playing 33-1/3 RPM discs. You hear and become familiar with common questions, answers, names, places, objects, directions — thousands of words and phrases that will help you to speak a foreign language. And the records are made of pure, unbreakable vinylite.

UNIQUE COMPANION VOLUMES

The comprehensive Conversation Manual that you receive repeats in print each recorded lesson — so that you constantly see the words and phrases you hear. You read the lesson over, put on the record, and follow the spoken words in print. You benefit from the double impact of both seeing and hearing. It is as simple as that! And the Common Usage Dictionary provides you with over 16,000 frequently used words and phrases, translated from the language of your choice into English and vice-versa, so that you can grasp them at a glance. Entire course consisting of 4 records and 2 books. Shpg. wt., 4 lbs.

Specify language desired

Net 9.95

HI-FIDELITY PORTABLE AUTOMATIC

3 SPEED PHONOGRAPH

- COLLARO—the world's finest Hi-Fi Intermix Record Changer
- G.E. Variable Reluctance Triple Play Cartridge
- Dual Sapphire Styli

It took a whole page elsewhere in this catalog to describe the fine features of the world famous Collaro changer made in England. Powerful 4-pole motor, weighted turntable and featherweight tone arm both mounted on ball bearings jam-proof mechanism, automatic muting switch—are a few of its features. It's equipped with the equally famous G.E. high fidelity triple-play RPX-050A cartridge that covers a frequency range of 25-20,000 cycles! Add to this a heavy 8" wide range speaker, full range tone control and volume control, a triple negative feedback circuit, tone compensating network, and an excellent amplifier—and you have a real high fidelity phonograph. Covered in green or maroon moquette with linen trim and gold grilles. Size 18 1/2" x 15 1/2" x 9". Shpg. Wt. 26 lbs.



PH-35 **Net 69.50**

NEW! GE RUMBLE FILTER



8.33

Suppresses or completely eliminates turntable rumble and unwanted signals below 50 cycles caused by irregularities in record disks. Also protects speaker from harmful sub-audio surges. Minimizes low frequency distortion. Gives sharp cutoff of 12 db per octave below 50 CPS. Self contained, no power supply required. Has standard phono input jack; and 19" output lead with phono plug, on-off switch. Size: 2" H x 2 3/8" W x 3 1/2" D, with convenient mounting bracket. Shipping weight 1 1/2 lbs.

G.E. Type A1-903 Filter

Net 8.33

MODERN AND MAGNIFICENT

TERRIFIC SAVINGS on AUTOMOBILE RADIOS

Motorola

AUTO

ANTENNAS

UNIVERSAL TYPES

These compact models combine the power supply, tuning unit and speaker all in one complete radio. Install easily under dash of most cars. Plates available for in-dash installation per chart below

MOTOROLA MODEL 396 TOP CAR RADIO VALUE

Five tube plus rectifier, Big PM speaker, Slide rule dial, manual tuning.

FOR UNDERDASH MOUNTING. Shpg. Wt. 12 lbs.

MODEL 396 — 6 — For 6 Volt Cars 36.50
MODEL 396 — 12 — For 12 Volt Cars 36.50

MOTOROLA MODEL 556

PUSH BUTTON AUTOMATIC TUNING AT BUDGET PRICE

Complete, all in one automatic push button model for easy installation in-dash or under dash of most cars, has Variable Tone Control and giant 5 1/2" extended tone speaker. Shpg. Wt. 13 lbs.

MODEL 556 — 6 — For 6 Volt Cars 47.95
MODEL 556 — 12 — For 12 Volt Cars 47.95

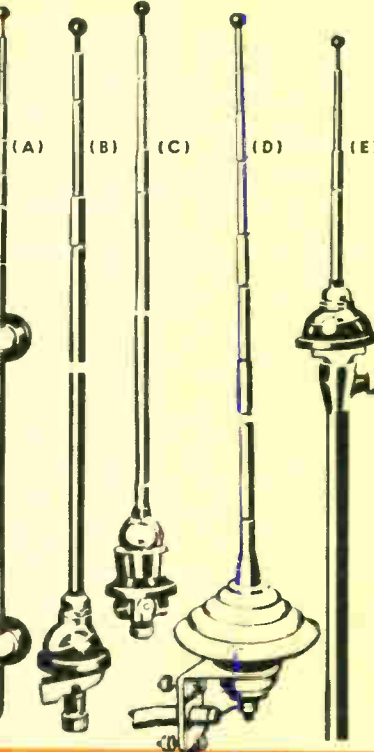
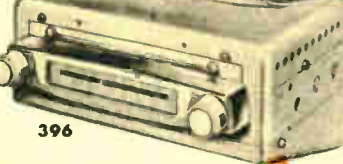

DELUXE PUSH-BUTTON 596

• WITH EXTERNAL 6" x 9" SPEAKER

Brand new — best buy — push-button model Famous no-fade, Volumetric eliminates "signal drop". "Elimin-noise" circuit quiets hum and other interference. "Power-Pack" chassis uses 5 tubes plus rectifier — "acoustinator" tone control — giant 6" x 9" speaker — slide rule dial — remarkable fidelity, 6 or 12 volt operation. "Tailored-to-your-car" appearance.

569-6 for 6 volt cars Net 51.95
596-12 for 12 volt cars Net 51.95

TRIM PLATES FOR 596

SPECIFY YEAR AND MAKE OF CAR

YEAR	MAKE	NET
55-56	DODGE	4.75
56	FORD	5.25
55-56	PLYMOUTH	6.95
55-56	PONTIAC	4.35

MOTOROLA SPECIAL CUSTOM SERIES

FORD - CHEVROLET - MERCURY

PUSH BUTTON TUNING



Perfect custom fit — simplest installation. Powerful circuit uses 5 tubes plus rectifier. Heavy 6" x 9" PM speaker — automatic volume control — acoustinator tone control — low battery drain — 6 or 12 volt operation. Specifically designed to fit your car.

MODEL CTA4 — for Chevrolet 53-54 Net 58.95
*MODEL CTA6T — for Chevrolet 55-56 Net 59.95
*MODEL BKA6T — for Buick -56 Net 59.95
MODEL CTA4 — for Ford 49-50 Net 58.95
MODEL CTA4 — for Mercury 52-53-54 Net 63.75
*TRANSISTOR POWERED

THE UNIVERSAL CUSTOM - MANUAL



Here is a revolutionary design—a car radio so compact and readily installed that it fits virtually any car new or old. Can be slipped into practically any dash dial opening. Has "Volumetric" control which completely eliminates the annoying "signal-drop" when you pass under a viaduct, over a bridge or between tall buildings. Has 5 tubes plus rectifier with iron core coils, and separate powerful 6 x 9 PM speaker. Trim plates are available as listed below to make a custom installation for many cars.

Motorola 6M-6 — 6 Volt less trim plate 38.98
Motorola 6M-12 — 12 Volt less trim plate 38.98

TRIM-PLATES FOR 6M—Specify make and year of car

YEAR	MAKE	NET	YEAR	MAKE	NET
54-55-56	BUICK, 12 volt	4.35	52-53-54-55-56	MERCURY	4.35
53-54-55-56	CHEVROLET	4.35	54-55-56	OLDSMOBILE	4.35
55-56	DeSOTO	4.35		12-volt	
55-56	DODGE	4.75	55-56	PACKARD	4.35
53-54	DODGE	4.35	53-54-55-56	PLYMOUTH	4.35
49-50	FORD	4.35	51-52	PLYMOUTH	9.35
52-53-54	FORD	4.35		w/o Grille	
55	FORD	6.95	55-56	PONTIAC	4.35
56	FORD, 12 volt	4.35	53-54-55-56	STUDEBAKER	4.35
			53-54-55-56	VOLKSWAGON	4.35

STANDARD SIDE COWL (A)

3 sections, extends to 61 inches from 25" collapsed. Tanite static ball, 2 black stand-off insulators—36" lead. Shpg. wt. 1 1/4 lbs.

AA-17 Net 1.59

UNIVERSAL MOUNT AERIAL (C)

3 sections, extends to 60" but for top cowl, rear deck mounting, or almost anywhere on car. Adjusts to any angle. 36" lead. Shpg. wt. 1 1/4 lbs.

AA-21 Net 2.59

DELUXE SIDE COWL (A)

For long distance and greater sensitivity. 4 sections, extends to 97" from 31" collapsed. Chrome static ball and 2 chrome capped bakelite insulators, 36" lead. Shpg. wt. 1 1/2 lbs.

AA-15 Net 3.11

HOT-ROD AERIAL (D)

4 section, extends to 108" from 35" collapsed. Has shock absorbing solid rubber mount, red tanite static ball, red ceramic insulators. For rear mount on fender or under trunk door. With 15 foot polyethylene cable. Shpg. wt. 3 lbs.

AA-23 Net 4.98

TOP COWL MOUNT (B)

3 sections, extends to 55 1/2" from 23" collapsed. Chrome static ball, chrome trimmed bakelite insulator. Single hole mount, final tighten on car exterior. 36" lead. Shpg. wt. 1 1/4 lbs.

AA-21 Net 2.19

DISAPPEARING AUTO ANTENNA (E)

For concealed installation on fender or top cowl. 3 sections, collapses to 7" and extends to 52". Chrome static ball. Self-aligning adjustment. 39" lead. Shpg. wt. 2 lbs.

AA-24 Net 3.15



MOTOROLA
SET FOR
1954 — 1955
BUICK

39.72

Mounts perfectly with matching plate supplied in all 54-55 Buick 12 volt cars. Completely self contained, has 5 tubes plus rectifier and big PM speaker. Shpg. wt. 13 lbs.



TRANSISTORS ~ DIODES

RAYTHEON



TEXAS INSTRUMENT



MARVELCO



GENERAL ELECTRIC TRANSISTORS



Type	Class	Net Each	Appl. cation	Freq. Cutoff Mc	** α/β	Coll. Pwr. Dissip. Mw	Pwr. Gain db	DC Coll. Volts	DC Coll. Ma	Coll. Cutoff Ua	Oper. Temp. °C
2N43	p-n-p	7.15	AF	2.5	0.98	150***	44	-45	-50	15	100
2N44	p-n-p	3.95	AF	2.5	0.97	150***	43	-45	-50	15	100
2N45	p-n-p	3.25	AF	2.5	0.94	150***	30	-45	-50	15	100
2N76	p-n-p	2.80	AF	7.5	0.99	50	42	-20	-10	10	60
2N78	n-p-n	3.05	RF-IF	6.0	50	65	50	15	20	6.0	85*
2N81	n-p-n	6.40	AF	60	50	50	38	-20	-15	16	100
2N107	p-n-p	1.25	AF	1.0	0.95	50	38	-12	-10	10	60
2N123	p-n-p	7.40	Switch RF-IF	8.0	0.98	100		-15	-125	6.0	85*
2N135	p-n-p	2.70	RF-IF	4.5	20	100		-20	-50	5.0	85*
2N136	p-n-p	3.10	RF-IF	6.5	40	100		-20	-50	5.0	85*
2N137	p-n-p	6.55	RF-IF	10.0	60	100		-10	-50	5.0	85*
2N167	p-n-p	7.85	Switch	8.0	0.975	65	30	75	1.5	85*	85*
2N169	p-n-p	2.65	AF	2.5	20	50	12	15	20	6.0	75*
2N170	n-p-n	3.05	AF	2.5	20	25	39	6	20	5.0	50
4JD1A17	p-n-p	6.40	AF	2.5	0.985	150	39	-45	-50	16	85*
USAF 2N43A	p-n-p	6.80	AF	1.0	39	150***	39	-45	50	16	85*
2N168	n-p-n	2.90	IF	6.0	20	50	30	15	-20	2	85
2N186	p-n-p	2.70	AF	0.8	24	75†	28	-23	200	16	60
2N186A	p-n-p	3.30	AF	0.8	24	180††	30	-25	200	16	60
2N187	p-n-p	2.95	AF	1.0	36	75†	30	-25	200	16	60
2N187A	p-n-p	3.65	AF	1.0	36	180††	32	-25	200	16	60
2N188	p-n-p	3.40	AF	1.2	54	75†	32	-25	200	16	60
2N188A	p-n-p	4.10	AF	1.2	54	180††	34	-25	200	16	60
2N189	p-n-p	2.45	AF-Driver	.8	24	75	37	-25	50	16	60
2N190	p-n-p	2.65	AF-Driver	1.0	36	75	39	-25	50	16	60
2N191	p-n-p	2.90	AF-Driver	1.2	54	75	41	-25	50	16	60
2N192	p-n-p	3.25	AF-Driver	1.5	75	75	43	-25	50	16	60

†300 Mw Power Output Class B; ††750 Mw Power Output Class B. α/β = Current Amplification; α is decimal, β is whole number.
* Storage Temperature; ** Average rating, all other ratings maximum; *** Power output 45 Mw



RAYTHEON TRANSISTORS



Type	Class	Net Each	Appl. cation	Freq. Cutoff Mc	* α/β	Coll. Pwr. Dissip. Mw	Power Gain db	Noise db	DC Coll. Volts	DC Coll. Ma	* Coll. Cutoff Ua	Oper. Temp. °C
2N63	p-n-p	3.55	AF-RF	0.6	22	33	39	25	-22	-10	6.0	85
2N64	p-n-p	3.95	AF-RF	0.8	45	33	41	22	-15	-10	6.0	85
2N65	p-n-p	4.35	AF-RF	1.2	90	33	42	20	-12	-10	6.0	85
2N106/CK727	p-n-p	4.35	Low Noise-AF	0.8	25	30	36	12	-6	-10	12	85
2N111/CK759	p-n-p	2.80	RF-IF	3.0	40				-6	-5	1.0	85
2N112/CK760	p-n-p	2.80	RF-IF	5.0	40				-6	-5	1.0	85
2N113/CK761	p-n-p	7.60	RF-IF	10.0	45				-6	-5	1.0	85
2N114/CK762	p-n-p	9.50	RF-IF	20.0	65				-6	-5	1.0	85
2N130	p-n-p	2.05	AF	0.6	22		39	25	-22	-10	6.0	85
2N131	p-n-p	2.05	AF	0.8	45		41	22	-15	-10	6.0	85
2N132	p-n-p	2.05	AF	1.2	90		42	20	-12	-10	6.0	85
2N133	p-n-p	2.40	Low Noise-AF	0.8	45		36	12	-15	-10	12	85
2N138	p-n-p	2.05	AF**		140	50***	30		-12	-20	6.0	40
CK721	p-n-p	2.40	AF-RF	0.8	45		41	22	-15	-10	6.0	70
CK722	p-n-p	.99	AF-RF	0.6	22		39	25	-22	-10	6.0	70
CK725	p-n-p	2.80	AF-RF	1.2	90		42	20	-12	-10	6.0	70
CK790	p-n-p	57.00	Switch, AF	0.4	14	50			-100			135
CK791	p-n-p	92.00	Switch, AF	0.6	24	50			-100			135
CK793	p-n-p	92.00	Switch, AF	0.5	16	50			-100			135

*Average ratings; All other ratings are maximum; **Class β Push-Pull operation; *** Power output; α/β = Current Amplification.



RCA TRANSISTORS



Type	Class	Net Each	Appl. cation	Freq. Cutoff Mc	* α/β	Coll. Pwr. Dissip. Mw	Power Gain db	* Noise db	* DC Coll. Volts	* DC Coll. Ma	Coll. Cutoff Ua	Oper. Temp. °C
2N77	p-n-p	2.80	AF	0.7	55	35	41	13	-25	-15	-10	50
2N104	p-n-p	3.15	AF	0.7	44		41	12	-30	-50	-10	70
2N105	p-n-p	2.85	AF	0.75	55	35	42	9	-25	-15	-5	50
2N109	p-n-p	2.10	AF**		70	50***	33		-25	-10	-10	50
2N139	p-n-p	2.80	IF	4.7	48	35	30		-16	-15		70
2N140	p-n-p	4.30	Conv.	7.0	45	35	27		-16	-15		70
2N175	p-n-p	7.80	AF***	0.85	65	20	43	6	-10	-2		50

*Maximum ratings, all other ratings average; **Large signal audio applications; ***Special low-noise, low-level audio, ***Power Output 160 Mw; α/β = Current Amplification.

GENERAL ELECTRIC DIODES—RECTIFIERS

GENERAL PURPOSE AND T.V.

TYPE	NET	TYPE	NET
1N34A	.80	1N72	1.00
1N38A	1.40	1N73	16.20
1N48	.65	1N74	12.35
*1N48	1.80	1N75	2.65
1N51	.50	*1N75	6.00
1N52	1.40	1N81	1.95
*1N52	3.35	1N285	1.20
1N54A	1.50	1N314	15.85
1N58A	1.45	1N355	1.90
1N63	2.50	G4	2.25
*1N63	6.00	G7A	1.00
1N64	.50	G7B	1.20
1N65	.65	G7C	1.20
1N69	.90	G7D	2.40
1N70	2.40	G7E	2.40

*—Matched Pair

JUNCTION RECTIFIERS

TYPE	NET	TYPE	NET
1N91	1.23	1N153	6.90
1N92	2.88	1N158	9.38
1N93	3.60	1N315	3.96
1N151	4.14	1N368	3.03
1N152	5.35	USNIN 93	3.96

RCA DIODES

TYPE	NET	TYPE	NET
1N34A	.58	1N55A	2.10
1N38A	1.40	1N56A	1.15
1N58A	1.15	1N58A	1.30

SYLVANIA DIODES

TYPE	NET	TYPE	NET
1N21A	2.20	1N78	10.80
1N21B	2.90	1N78A	20.15
*1N21B (2)	8.00	*1N78A (2)	47.50
1N21BR	5.75	1N79	15.70
*1N21B	14.00	1N79	2.50
1N21BR	14.00	1N81	1.05
1N21C	5.05	1N82	.90
*1N21C (2)	15.00	1N82A	1.00
1N21D	18.00	1N105	.50
1N23A	1.10	1N109	.50
1N23B	1.85	1N111	1.30
*1N23B (2)	4.30	1N112	1.05
1N23BR	4.30	1N113	1.65
*1N23B	10.80	1N114	1.05
1N23BR	10.80	1N115	.95
1N23C	3.65	1N120	1.10
1N23CR	9.40	1N132	.50
*1N23C (2)	14.40	1N137A	3.85
*1N23C	25.90	1N138A	3.85
1N23CR	25.90	1N160	5.75
1N23D	36.00	1N172	1.05
1N23DR	50.00	1N193	5.75
*1N23D	107.75	1N194	6.75
1N23DR	107.75	1N195	6.85
1N25	5.75	1N196	10.05
1N26	10.10	1N200	5.05
1N31	7.20	1N201	5.05
1N32	14.50	1N202	5.05
1N34A	.75	1N203	5.05
1N35	2.20	1N204	5.05
1N38A	1.30	1N205	5.05
1N39	3.95	1N206	5.05
1N39A	4.70	1N207	5.05
1N40	12.25	1N208	5.05
1N41	11.50	1N209	5.05
1N42	17.25	1N210	5.05
1N53	43.15	1N211	5.05
*1N53 (2)	104.95	1N212	5.05
1N54A	1.05	1N213	5.05
1N55A	2.10	1N214	5.05
1N56	1.05	1N215	5.05
1N56A	1.10	1N216	7.20
1N58A	1.30	1N217	7.20
1N59	4.30	1N218	7.20
1N59A	5.05	1N219	7.20
1N60	.50	1N220	7.20
1N63	1.65	1N221	7.20
1N64	.50	1N222	7.20
1N65	.65	1N401	5.05
1N67	1.65	1N402	5.05
1N69	.75	1N403	5.05
1N70	2.25	1N404	5.05
1N71	7.20	1N405	5.05
1N72	1.00	1N406	5.05
1N76	4.30	1N407	5.05
1N77A	36.75	1N408	5.05

*Matched Pair



TRANSISTORS - DIODES



RAYTHEON



TEXAS INSTRUMENT

HUGHES



MARVELCO



RAYTHEON DIODES

TYPE	NET	TYPE	NET
1N34	.65	CK715	.65
1N66	.65	CK717	9.40
1N67	1.57	CK719	9.40
1N68	1.57	CK735	Use 1N300
1N294	.70	CK735A	Use 1N300A
1N295	.41	CK736	Use 1N301
1N297	1.35	CK736A	Use 1N301A
1N298	.95	CK737	Use 1N302
1N300	5.55	CK737A	Use 1N302A
1N300A	6.35	CK738	Use 1N303
1N301	5.55	CK738A	Use 1N303A
1N301A	6.35	CK739	Use 1N305
1N302	6.35	CK740	Use 1N306
1N302A	7.90	CK742	Use 1N307
1N303	5.55	CK775	34.50
1N303A	6.35	CK776	41.50
1N305	2.00	CK801	2.00
1N306	2.00	CK802	2.00
1N307	2.60	CK840	12.50
1N432	5.55	CK841	12.50
1N432A	6.35	CK842	14.75
1N433	5.55	CK843	15.50
1N433A	7.00	CK844	16.50
1N434	5.55	CK845	20.50
1N434A	7.00	CK850	Use 1N436
1N436	5.55	CK851	Use 1N437
1N438	5.55	CK852	Use 1N438
1N439	5.55	CK853	Use 1N439
1N460	5.55	CK856	Use 1N432
1N460A	6.35	CK856A	Use 1N432A
CK705	Use 1N66	CK858	Use 1N460
CK705A	Use 1N294	CK858A	Use 1N460A
CK706A	Use 1N295	CK860	Use 1N433
CK707	Use 1N67	CK860A	Use 1N433A
CK708	Use 1N68	CK861	Use 1N434
CK709	9.40	CK861A	Use 1N434A
CK710	.87	CK863	9.40
CK711	9.40	CK863A	11.00
CK713A	Use 1N298		

HUGHES GERMANIUM DIODES

Type	Net Each	Type	Net Each
1N558	5.04	1N118	1.16
1N68A	1.07	1N96	.55
1N67A	1.56	1N95	.65
1M99	1.62	1N94	.85
1M100	2.47	1N126*	.72
1M89	.55	1N127**	1.20
1M97	1.82	1N128***	1.01
1M98	1.66	1N198	2.02
1M116	.88	1N191	1.62
1N117	1.11	1N92	1.14

* Formerly 1N69A; ** Formerly 1N70A; *** Formerly 1N81A

HUGHES SILICON JUNCTION DIODES

Type	Net Each	Type	Net Each
HD6001	2.60	HD6007	5.53
HD6002	3.90	HD6008	5.85
HD6003	4.23	HD6009	4.06
HD6005	5.04	HD6011	5.69
HD6006	5.20		

RAYTHEON RF TRANSISTOR High Frequency Type Cut-Off Frequency Prox 3MC



CK-768 1.50

MARVELCO TRANSISTORS

Type	Class	Net Each	Application	Freq. Cutoff Mc	α/β	Coll. Pwr. Dissip. Mw	Pwr. Gain db	Pwr. Output Mw	Noise db	DC Coll. Volts	DC Coll. Ma	Coll. Cutoff Ua	Temp. °C
MF-1	p-n-p	3.65	RF-IF	5.0	0.975	75	28***		22	-20	-8	5	55
MF-2	p-n-p	3.50	RF-IF	10.0	0.975	75	28		22	-12	-8	5	55
IF-1	p-n-p	3.50	RF-IF	3.0	0.985	75	40		11	-25	-8	5	55
IF-2	p-n-p	3.00	RF-IF	3.0	0.97	75	37.5		22	-25	-8	10	55
IF-3	p-n-p	2.00	RF-IF	3.0	0.96	75	35		22	-25	-8	10	55
JP-1	p-n-p	4.75	PCWFR		0.90	350**		350**	15	-45	-50**	500	55
J-1	p-n-p	1.80	AUDIO		0.97	150		400**	11	-40	-10	15	55
J-2	p-n-p	1.60	AUDIO		0.94	150			22	-40	-10	15	55
J3	p-n-p	1.50	AUDIO		0.90	150			33	-40	-10	20	55
CQ-1	p-n-p	1.25	AUDIO		0.90	150			33	-40	-10	20	50
RF-1	p-n-p	1.50	RF-IF	2.5	0.94	75			33	-15	-8	10	50

All ratings max. except Freq. Cutoff and α/β (Current Amplification) are minimum.

* Ambient temperature. ** In Free Air, Higher figure with chassis attachment (heat sink), 1.5 Watt output in DC Switching Circuits (with heat sink). *** At 455kc Gain at 2 Mc 16.5 db for MF-1, 19.5 db for MF-2.

TEXAS INSTRUMENT TRANSISTORS

Type	Class	Net Each	Application	Freq. Cutoff Mc	α/β	Coll. Pwr. Dissip. Mw	Power Gain db	Noise db	DC Coll. Volts	DC Coll. Ma	Coll. Cutoff Ua	Oper. Temp. °C
300	p-n-p	1.72	AF	0.7	19	100		40	-30	-50	10	75
301	p-n-p	2.32	AF	1.0	49	100		35	-30	-50	10	75
302	p-n-p	2.72	AF	1.3	55	100		33	-30	-50	10	75
310	p-n-p	2.36	AF-Driver	1.0		2***		32	-20	-150	15	75
353	p-n-p	2.80	AF P-P			100****		23	-20	-150	15	75
903	n-p-n Si*	13.50	RF-Conv.	4.0	0.975	150	36.5	25	30	25	10	175
904	n-p-n Si	27.00	RF-Conv.	5.0	0.975	150	34	25	30	25	10	175
904A	n-p-n Si	36.00	RF-Conv.	8.0	1.000	150	34	25	30	25	10	175
905	n-p-n Si	36.00	RF-Conv.	6.0	1.000	150	34.5	25	30	25	10	175
951	n-p-n Si	27.00	AF-Servo		1.000	1000	34	50	60	5	175	
952	n-p-n Si	27.00	AF-Servo		1.000	1000	34	80	50	6	175	
953	n-p-n Si	27.00	AF-Servo		1.000	1000	34	120	40	8	175	
970	n-p-n Si	72.00	Servo			8.75W	21	120	140	10	150	
2N124	n-p-n	4.52	Switch	3.0	24	50		20	10	8	2	75
2N125	n-p-n	6.32	Switch	5.0	48	50		20	10	8	2	75
2N126	n-p-n	8.08	Switch	5.0	100	50		20	10	8	2	75
2N145	n-p-n	4.04	IF			65		3*	20	5	3	75
2N146	n-p-n	4.52	IF			65		3*	20	5	3	75
2N147	n-p-n	5.40	IF			65		3*	20	5	3	75
2N172	n-p-n	4.88	Conv.			65		3*	20	5	3	75
2N185/352	p-n-p	2.48	Audio		55	150****	40.5		-20	-150	15	50

All ratings are maximum. *Silicon — high temperature, low-level, high gain; **In free air; ***Power Output; ****250 Mw Power Output.

HUGHES GERMANIUM TRANSISTORS

Type	Class	Net Each	Application	Freq. Cutoff Mc	α/β	Coll. Pwr. Dissip. Mw	Noise db	DC Coll. Volts	DC Coll. Ma	Coll. Cutoff Ua	Oper. Temp. °C
HA5001	n-p-n	9.10	Computer-RF	2.5	1.0	500	18	20	100	10	85
HA5002	n-p-n	5.20	IF-Audio	1.0	0.965	500	18	20	100	10	85
HA5003	n-p-n	6.50	IF-Audio	1.5	0.99	500	18	20	100	10	85

ALL RATINGS MAX. *Rise Time (micro seconds).

SYLVANIA TRANSISTORS

Type	Class	Net Each	Application	Freq. Cutoff Mc	α/β	Coll. Pwr. Dissip. Mw	Power Gain db	Power Output Mw	DC Coll. Volts	DC Coll. Ma	Coll. Cutoff Ua	Oper. Temp. °C		
2N34	p-n-p	3.15	AF-Switch	0.6	40	50		1.25****	-25	-10	5.0	25		
2N35	p-n-p	2.55	AF-Switch	0.8	40	50		1.25****	-25	-10	5.0	25		
2N68	p-n-p	6.50	AF-Power	0.4	0.975	2.5W**	23	610***	-25	-1.5 Amp.	100	25		
2N94	n-p-n	2.85	RF-IF	3.5	0.97	50			20	10	3.0	25		
2N94A	n-p-n	5.05	RF-IF	6.0	0.97	50			20	10	3.0	25		
2N95	n-p-n	6.50	AF-Power	0.4	0.975	2.0W**	23	690***	25	1.5 Amp.	100	25		
2N101	p-n-p	6.90	AF-Power	0.4	0.975	4.0W			23	600***	-25	-1.5 Amp.	100	25
2N102	n-p-n	6.50	AF-Power	0.4	0.975	4.0W			23	600***	25	1.5 Amp.	100	25

*Maximum ratings, all others are average; Temperature is ambient. **In Free Air, 4.0W with heat sink. ***Class A, 5 watt Push Pull Class B (Common Emitter or Collector), 10 Watts (Common Base), 12 Watts (Switching). ****Class B, Push-Pull (2 Units); α/β = Current Amplification.

Argonne TRANSISTOR TRANSFORMERS

AT LAST A COMPLETE LINE OF QUALITY TRANSFORMERS FOR EVERY TRANSISTOR APPLICATION AT A PRACTICAL PRICE!

- Nickel-Steel and Silicon Steel Laminations • Wound on Nylon Bobbins • Mylar Outer Wrap • Color Coded Leads

Have you been experimenting with transistor circuits? And have you been forced to make-do with compromise transformers or improvised units? And have you had to pay from \$6.00 to \$12.00 for them? The Argonne line brings you a wide variety for experimentation as well as for replacement. Efficiently designed to meet the needs of miniaturization and engineered to provide more power handling capacity and improved frequency response with minimum distortion. All are nickel-steel laminations except asterisk which are silicon steel. Average net weight 1 1/4 oz; average shipping wt. 4 ozs.

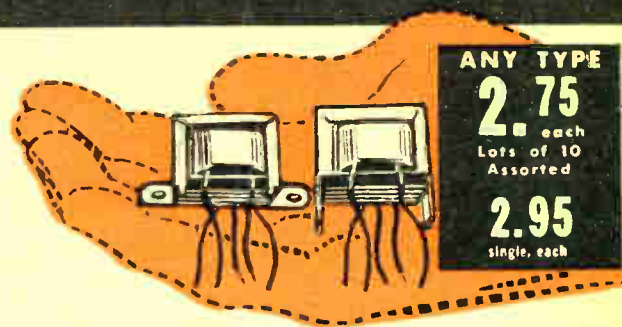

ANY TYPE
2.75 each
Lots of 10 Assorted
2.95 single, each

ARGONNE NUMBER	TYPE	IMPEDANCE PRI- MARY OHMS	SECOND- ARY OHMS	UNBALANCED CURRENT PRI. D.C. MA	POWER MILLI- WATTS	D.C. RESISTANCE PRI. OHMS	SEC. OHMS	OVERALL SIZE
AR-100	Input	200,000	1,000	.0	100	3600	90	1" x 3/4" x 3/4"
AR-126	Input	150,000	1,500 CT	2.	100	3700	55	1" x 3/4" x 3/4"
AR-101	Input	100,000	3,000 CT	.5	100	3600	60	1" x 3/4" x 3/4"
AR-102	Input	100,000	1,500 CT	.5	100	3600	40	1" x 3/4" x 3/4"
AR-127	Input	50,000	3,000 CT	1.	100	2000	50	1" x 3/4" x 3/4"
AR-128	Input	50,000	1,500 CT	2.	100	3000	50	1" x 3/4" x 3/4"
AR-129	Input	50,000	1,000	2.	100	2500	20	1" x 3/4" x 3/4"
AR-103	Driver	20,000	2,000 CT	1.	100	400	50	1" x 3/4" x 3/4"
AR-104	Driver	20,000	1,000	.0	100	400	50	3/4" x 3/8" x 3/8"
AR-105	Driver	20,000	400	1.	100	600	30	1" x 3/4" x 3/4"
AR-130	Output	20,000	8	.5	100	400	0.6	3/4" x 3/8" x 3/8"
AR-131	Output	20,000	3.2	.5	100	400	0.3	3/4" x 3/8" x 3/8"
AR-106	Driver	16,000	4,000	1.	100	620	350	3/4" x 3/8" x 3/8"
AR-107	Driver	15,000	200	1.5	250	1000	20	1" x 3/4" x 3/4"
AR-108	Driver	10,000	3,000 CT	.0	100	200	100	3/4" x 3/8" x 3/8"
AR-109	Driver	10,000	2,000 CT	.0	100	500	50	3/4" x 3/8" x 3/8"
AR-110	Output	10,000	16	2.	150	600	2.5	3/4" x 3/8" x 3/8"
AR-132	Output	10,000	8	1.	100	600	.6	3/4" x 3/8" x 3/8"
AR-133	Output	10,000	3.2	1.	100	600	.3	3/4" x 3/8" x 3/8"
AR-111*	Output	5,000	100	1.	100	600	10	3/4" x 3/8" x 3/8"
AR-134	Output	4,000 CT	8	4.	250	150	.8	1" x 3/4" x 3/4"
AR-135	Output	4,000 CT	3.2	4.	250	150	.3	1" x 3/4" x 3/4"
AR-112	Output	3,500	200	1.	150	120	25	1" x 3/4" x 3/4"
AR-113*	Driver	3,000 CT	1,000	9.	150	100	60	3/4" x 3/8" x 3/8"
AR-114	Output	2,500	11	10.	150	50	1.1	3/4" x 3/8" x 3/8"
AR-115	Input	2,000	8,000 CT	.0	150	660	1	1" x 3/4" x 3/4"
AR-116	Output	2,000	200	4.	120	20	20	1" x 3/4" x 3/4"
AR-136*	Output	1,000 CT	100	4.	250	120	10	1" x 3/4" x 3/4"
AR-137*	Output	1,000 CT	8	4.	250	120	9	1" x 3/4" x 3/4"
AR-138*	Output	1,000 CT	3.2	4.	250	120	3	1" x 3/4" x 3/4"
AR-117	Output	500 CT	30	.0	100	20	1.5	3/4" x 3/8" x 3/8"
AR-118	Output	500 CT	16	.0	100	20	1.5	3/4" x 3/8" x 3/8"
AR-119	Output	500 CT	3.2	.0	100	20	.3	3/4" x 3/8" x 3/8"
AR-120*	Output	400 CT	11	1.	150	20	9	3/4" x 3/8" x 3/8"
AR-121*	Output	300 CT	3.2	.0	150	20	.25	3/4" x 3/8" x 3/8"
AR-139*	Output	250 CT	8	2.	250	15	7	1" x 3/4" x 3/4"
AR-122*	Output	250 CT	3.2	.0	150	11	.3	1" x 3/4" x 3/4"
AR-123	Input	200	2,000 CT	2.	150	11	50	1" x 3/4" x 3/4"
AR-124*	Output	200 CT	16	.0	250	20	1.3	3/4" x 3/8" x 3/8"
AR-140*	Output	200 CT	3.2	2.	100	10	.3	3/4" x 3/8" x 3/8"
AR-125	Input	3	4,000	.0	250	14	50	3/4" x 3/8" x 3/8"

UTC SUBOUNCER AND SUB-SUBOUNCER TRANSFORMERS



For hearing aids, vest pocket radios, midget devices and other ultra-miniature equipment. Average frequency response 200-10,000 cps ± 3 db. High efficiency obtained through special nickel iron core materials and winding methods. Cellulose acetate insulation; 4 color-coded leads. SO dimensions: 9/16" x 7/16"; SSO, 7/16" x 5/16". Average shpg. wt. 2 oz. SO indicates subouncer units and SSO sub-subouncer. Fixed impedance ratio; 1250:1 for SO-1 and SSO-1; 1:50 for SO-3 and SSO-3; SO-5, 3000 ohms DC resistance; SSO-5, 4400 ohms.

Type	Use	Pri. Imp.	Pri. DC	Sec. Imp.	NET
SO-1	Input	200, 50	0	250K, 62.5K	3.92
SO-2	Audio, 1:3	10,000	0-.25 ma	90K	3.53
SO-3	Pl. to line	10K, 25K	3, 1.5 ma	200, 500	3.53
SO-4	Output	30,000	1 ma	50	3.53
SO-5	Reactor	50 hys @	1 ma DC*		2.94
SO-6	Output	100,000	.5 ma	60	3.92
SO-7	Interstage	20K, 30K	.5; .5 ma	800, 1200	2.94
SO-8	Interstage, PP Sec.	10,000	1 ma	2,000 CT	4.12
SO-9	Output, PP	500 CT	0 ma	3.2	3.53

SUB-SUBOUNCER TRANSFORMERS

Type	Use	Pri. Imp.	Pri. DC	Sec. Imp.	Net
SSO-1	Input	200, 50	0	250K, 62.5K	4.12
SSO-2	Audio, 1:3	10,000	0-.25 ma	90K	4.41
SSO-3	Pl. to line	10K, 25K	3, 1.5 ma	200, 500	3.63
SSO-4	Output	30,000	1 ma	50	3.63
SSO-5	Reactor	50 hys @	ma DC*		3.63
SSO-6	Output	100,000	.5 ma	60	3.63
SSO-7	Interstage	20K; 30K	.5; .5 ma	800; 1200	2.94
SSO-8	Interstage, PP Sec.	10,000	1 ma	2000 CT	4.12
SSO-9	Output	10,000	2 ma	16	2.94
SSO-10	Output	10,000	2 ma	3.2	2.94
SSO-11	Output	500; 600	3.5; 3.5	50; 60	2.94
SSO-12	Output	1K; 1.2K	3.3 ma	50; 60	2.94
SSO-13	Crystal Input	200,000	0 ma	1,000	4.41

UTC DOTS... TRANSISTOR TRANSFORMERS

5/16" DIA. . . . 13/32" LONG . . . 1/10th OZ. WEIGHT. High power rating, excellent response, low distortion, high efficiency, moisture proof, rugged, anchored leads.

Type	Use	Level Mw	Pri.	Imp.	Pri. Dc.	Sec. Imp.	Net
DOT-1	Interstage	50	30K; 20K	.5; .5 ma	1200; 800	5.88	
DOT-2	Output	100	600; 500	3; 3 ma	60; 50	5.19	
DOT-3	Output	100	1200; 1000	3; 3 ma	60; 50	5.19	
DOT-4	Output	100	600	3 ma	3.2	5.19	
DOT-5	Output	100	1200	2 ma	3.2	5.19	
DOT-6	Output	100	10,000	1 ma	3.2	5.88	
DOT-7	Input	25	200,000	0 ma	1000	6.47	
DOT-8	Reactor		3.5 Hys. at 2 MA, D.C. 630 Ohms DC			4.70	

TRANSISTOR AUDIO TRANSFORMER

1.69

Subminiature, compact, high grade transistor audio transformers.

No.	Type	Pri.	Sec.	Size	Net
TR-79	Driver	7,500	1,000	3/4" x 1" x 3/4"	1.69
TR-80	Driver	10,000	2,000	3/4" x 3/4" x 3/4"	1.69
TR-81	Interstage	5,000	1,000	3/4" x 3/4" x 3/4"	1.69
TR-82	Driver	16,000	2,000	3/4" x 3/4" x 3/4"	1.69
TR-83	Output	500	3.2	3/4" x 3/4" x 3/4"	1.69
TR-86	Push-Pull Output	330	12	3/4" x 1" x 3/4"	1.69
Transistor Audio - For Power Transistors - 5 Watt					
TR-84	Output	48	3.2	1/2" x 1/2" x 1/2" x 1/2"	1.69
TR-85	Driver	100	200	1/2" x 1/2" x 1/2" x 1/2"	1.69





LAFAYETTE SPECIALIZES IN MINIATURE PARTS FOR TRANSISTOR CIRCUITS



TRANSISTOR ULTRA-MINIATURE ELECTROLYTIC CONDENSERS

7/32" Diameter — 25/32" Long

Latest subminiature electrolytic capacitors. Hermetically sealed aluminum cases, especially suitable physically and electrically for application in transistor and miniature electronic circuits. Long shelf-life, stable capacity and low leakage current. Super value in ultra-miniature electrolytics.

Cat. No.	Description	Dia.	Length	Price
CF-100	2 mfd 6 Volt	7/32"	25/32"	.29
CF-101	4 mfd 6 Volt	7/32"	25/32"	.29
CF-102	8 mfd 6 Volt	7/32"	25/32"	.29
CF-103	10 mfd 6 Volt	9/32"	25/32"	.29
CF-104	30 mfd 6 Volt	9/32"	25/32"	.29
CF-105	50 mfd 6 Volt	11/32"	25/32"	.35
CF-106	100 mfd 6 Volt	11/32"	1-7/32"	.39
CF-120	2 mfd 15 Volt	7/32"	25/32"	.29
CF-121	6 mfd 15 Volt	7/32"	25/32"	.31
CF-122	10 mfd 15 Volt	9/32"	25/32"	.33
CF-123	20 mfd 15 Volt	13/32"	25/32"	.33
CF-124	30 mfd 15 Volt	13/32"	25/32"	.33
CF-125	50 mfd 15 Volt	15/32"	25/32"	.36
CF-126	100 mfd 15 Volt	16/32"	1-12/32"	.45
CF-140	2 mfd 25 Volt	7/32"	25/32"	.29
CF-141	6 mfd 25 Volt	11/32"	25/32"	.29
CF-142	10 mfd 25 Volt	11/32"	25/32"	.31
CF-143	25 mfd 25 Volt	13/32"	25/32"	.35
CF-144	50 mfd 25 Volt	13/32"	27/32"	.40

TRANSISTOR SOCKETS



• A LIFESAVER FOR YOUR TRANSISTORS!

Transistors may be damaged by the heat of soldering. The utilization of these specially developed transistor sockets prolongs the life of your transistor. Moulded from mica-filled low loss bakelite. Silver plated beryllium copper contacts. *For printed circuits. Size is overall.

Stock No.	Type	Cont.	Size	Net
M5-275	A	3	15/32"x11/32"x7/32"	.19
M5-253	A	5	15/32"x11/32"x7/32"	.19
M5-252	B	5	1/4" x 3/16"x3/8"	.22
M5-149*	C	5	1/4" x 3/16"x 3/8"	.22

SUBMINIATURE SOCKETS



Used in all subminiature radios, hearing aids and electronic devices that require subminiature tubes. Mica-filled low-loss bakelite. Silver-plated beryllium copper contacts. Shpg. wt. 2 oz. Size is overall.

Stock No.	Type	Cont.	Size	Net
M5-253	A	5	15/32"x11/32"x7/32"	.19
M5-254	A	6	13/32"x7/32"x9/32"	.19
M5-255	A	7	31/64"x7/32"x5/32"	.22
M5-256	B	8	13/32"x7/16"	.39

B & W MINIDUCTORS

Air wound, polystyrene insulation. Easily cut to size. All ore 2" Long except 1" Diameter ore 3"

Diam.	4 Turns		8 Turns		16 Turns		32 Turns		Net
	Type	Per In.	Type	Per In.	Type	Per In.	Type	Per In.	
1/2"	3001	3002	3003	3004					.36
3/8"	3005	3006	3007	3008					.45
5/16"	3009	3010	3011	3012					.54
1"	3013	3014	3015	3016					.60

SPRAGUE TRANSISTOR ULTRA-MINIATURE ELECTROLYTIC CONDENSERS

3/16" Diameter 1/2" Long



A New approach to reliability in reasonably-priced sub-miniature electrolytic capacitors. Smallest hermetically-sealed aluminum electrolytic capacitors made — They'll fit anywhere and work anywhere. Extremely low leakage current, long shelf life. Excellent replacement capacitors for transistorized radio sets presently on the market. Ideal for applications in Hearing Aids and other Miniature Electronic Equipment.

Catalog No.	Capacity	WVDC	Diam.	Length	Net
TE-1010	5 mfd	1	3/16	9/16	.58
TE-1055	25	3	1/4	5/8	.58
TE-1060	110	3	3/8	3/4	.65
TE-1080	1	6	3/16	1/2	.58
TE-1081	2	6	3/16	1/2	.58
TE-1082	4	6	3/16	1/2	.58
TE-1083	4	6	3/16	1/2	.58
TE-1084	5	6	3/16	1/2	.58
TE-1086	8	6	1/4	3/4	.61
TE-1087	10	6	1/4	3/4	.61
TE-1089	15	6	1/4	3/4	.61
TE-1091	25	6	1/4	3/4	.61
TE-1092	30	6	3/8	3/4	.65
TE-1095	40	6	3/8	3/4	.65
TE-1100	50	6	3/8	3/4	.65
TE-1101	60	6	3/8	3/4	.65
TE-1116	15	10	1/4	3/4	.61
TE-1118	25	10	3/8	3/4	.61
TE-1127	5	12	1/4	3/4	.61
TE-1128	10	12	1/4	3/4	.61
TE-1202	5	25	1/4	3/4	.65
TE-1203	6	25	1/4	3/4	.65
TE-1204	10	25	3/8	3/4	.67
TE-1205	15	25	3/8	3/4	.67

CAMBRIDGE THERMIONIC CORPORATION SLUG-TUNED COILS



For TV traps, broadband RF amplifiers, general HF circuits, etc. Coil bodies of LSM, L53 and L54 are HF paper base phenolic; L55 and L56 are ceramic. L53 has larger slug and greater bandpass. L54 for larger inductance and Q. Slugs tunable from either end. Lacking feature. Sizes: LSM, 27/32x1/4" dia.; L53, 11/8x3/8" dia.; L54, 2x1/2" dia.; L55, 1-1/16x3/8" dia.; L56, 27/32x1/4" dia. Wt., 4 oz.

Type	Description	Net
L53	Coil Form	.53
L53	1 Mc Coil	1.02
L53	5 Mc Coil	.92
L53	10 Mc Coil	.95
L53	30 Mc Coil	.90
L53	60 Mc Coil	.90
LSM	Coil Form	.53
LSM	1 Mc Coil	1.00
LSM	5 Mc Coil	.95
LSM	10 Mc Coil	.90
LSM	30 Mc Coil	.90
LSM	60 Mc Coil	.90
L54	Coil Form	.72
L55	Coil Form	.70
L56	Coil Form	.63

CAMBRIDGE THERMIONIC PRINTED CIRCUIT COIL FORMS



An internally threaded phenolic tube with collars and solder lugs, with powdered iron core that is adjustable from either end of the form. A simple vertical mounting by punching two to four holes in board. Winding area on form is 11/16" long. Types SPC1 have 5/16" core, Types SPC2 have 3/8" core.

Type No.	Tube Diam.	O.D.	Number of Lugs	Net
SPC1-A-2L	.219"	.356"	2	.29
SPC1-A-3L	.219"	.356"	3	.29
SPC1-A-4L	.219"	.356"	4	.29
SPC2-B-2L	.285"	.426"	2	.29
SPC2-B-3L	.285"	.426"	3	.29
SPC2-B-4L	.285"	.426"	4	.29

MINIATURE KNOB



Plastic knob, only 3/8" diameter fits 1/8" shafts, for miniature components such as Ferris-loopstock, sub-miniature pots, etc. MS-185

Net 7¢

BARCO TRANSISTOR ULTRA-MINIATURE ELECTROLYTIC CONDENSERS

1/8" Diameter — 3/8" Long



For applications in Transistor and Miniature Electronic Circuits, small hermetically-sealed aluminum electrolytic condenser. Low leakage current, stable capacity. Will fit anywhere.

Type	Capacity	W.V.	Diam.	Length	Net
P25-.25	1/4 mfd	25V	1/8"	3/8"	.59
P25-.4	4 mfd	25V	1/8"	3/8"	.59
PT12-1	1 mfd	12V	1/8"	1/2"	.59
PT6-2	2 mfd	6V	11/64"	11/16"	.44
P6-8	8 mfd	6V	11/64"	11/16"	.44
P58-5	5 mfd	8V	11/64"	11/16"	.44
PS20-2	2 mfd	20V	11/64"	11/16"	.44
PT12-2	2 mfd	12V	3/16"	17/32"	.44
P6-25	25 mfd	6V	1/4"	11/16"	.44
P12-16	16 mfd	12V	1/4"	11/16"	.44
P25-8	8 mfd	25V	1/4"	11/16"	.44
P40-5	5 mfd	40V	1/4"	11/16"	.44
P70-3	3 mfd	70V	1/4"	11/16"	.44
P6-80	80 mfd	6V	23/64"	11/16"	.59
P25-25	25 mfd	25V	23/64"	11/16"	.59
P40-16	16 mfd	40V	23/64"	11/16"	.59
P70-10	10 mfd	70V	23/64"	11/16"	.59
P6-160	160 mfd	6V	23/64"	1-9/32"	.73
P25-50	50 mfd	25V	23/64"	1-9/32"	.73
P40-30	30 mfd	40V	23/64"	1-9/32"	.73
P70-20	20 mfd	70V	23/64"	1-9/32"	.73

AEROVOX TYPE P82 METALLIZED-PAPER CAPACITORS



Tiny AeroVox Metallized-Paper tubular units are self-heating to protect against surge voltages. Hyvol K impregnated. In moisture resistant wax impregnated cardboard cases. Up to 74% smaller than equivalent paper units. Standard Tolerance ±20%. Shpg. Wt. 2 oz.

200 VOLTS			400 VOLTS		
Mfd.	Size	Each	Mfd.	Size	Each
.01	1/4x1/4"	.35	.01	1/4x1/4"	.38
.02	1/4x1/4"	.35	.02	1/4x1/4"	.38
.03	1/4x1/4"	.35	.03	1/4x1/4"	.38
.05	1/4x1/4"	.35	.05	1/4x1/4"	.41
.1	1/4x1/4"	.41	.1	1/4x1/4"	.47
.25	1/4x1/4"	.53	.25	1/4x1/4"	.59
.5	1/4x1/4"	.62	.5	1/4x1/4"	.68
1.0	1/4x1/4"	.76	1.0	1/4x1/4"	.84
2.0	1/4x1/4"	1.86			

AEROVOX TYPE P83Z MICRO-MINIATURES



Ultra-small metallized-dielectric capacitor particularly suited to replace the low capacity paper units now used. Hyvol K impregnated. In humidity-resistant molded thermo-plastic cases. Shpg. Wt. 1 oz.

200 VOLTS			400 VOLTS		
Mfd.	Size	Each	Mfd.	Size	Each
.005	1/8x1/8"	.26	.002	1/8x1/8"	.26
.01	1/8x1/8"	.26	.003	1/8x1/8"	.26
.02	1/8x1/8"	.32	.01	1/8x1/8"	.32
.04	1/8x1/8"	.32			

CENTRALAB TYPE DM MIN-KAPS

Miniature capacitors for use where space is at a premium as in coils, pocket radios, hearing aids, etc. 17/32" long, 7/32" wide, 7/64" thick. Tolerance: .001 mfd to .002 mfd — 20% + 50%; .003 mfd to .01 mfd — 20% + 80%.



150 VOLTS D.C.W.					
Cap. Mfd.	Cat. No.	Net	Cap. Mfd.	Cat. No.	Net
.0001	DM-101	.21	.002	DM-202	.26
.0002	DM-201	.21	.003	DM-302	.26
.0003	DM-301	.21	.005	DM-502	.26
.0005	DM-501	.21	.01	DM-103	.38
.001	DM-102	.21	2X.005	DM2-502	.38



LAFAYETTE SPECIALIZES IN MINIATURE PARTS FOR TRANSISTOR CIRCUITS



SUBMINIATURE VOLUME CONTROLS



For Transistor & Subminiature Tube Circuits with S.P.S.T. Switch Size 23/32" Dia. 1/2" Deep.

The ultra small volume control is a positive marvel of engineering skill. Designed with today's trend toward miniaturization. It forms a perfect complement to subminiature transistor and tube circuits. Switch rating 6.5 amp at 1.5 Volt; 2 amps at 45 Volt. Size: Dia 23/32"; only 1/2" deep.

With S.P.S.T. Switch

- VC-42 - 5,000 ohm
- VC-43 - 10,000 ohm
- VC-44 - 15,000 ohm
- VC-45 - 25,000 ohm
- VC-46 - 1/2 Meg
- VC-47 - 1 Meg

79¢

in lots of 10

89¢

single each

HIGH-GAIN LOOPSTICK ANTENNAS



An excellent selection of highly efficient, low-cost, ferrite core antennas. Give high gain across complete broadcast band from 540 to 1600 KC when tuned with standard 365 mmf tuning condenser. Ideal as replacement for bulky, old-fashioned loop antennas on back of AM broadcast receivers. Give sensitive reception from all directions—you don't have to rotate your radio to pick up weak stations.

A. VARI-LOOPSTICK. A revolutionary antenna development. An extremely small yet very powerful replacement antenna with a "Q" of up to 240-275. Boosts sensitivity and signal to noise ratio considerably in portable receivers. With adjustable ferrite core for maximum peaking efficiency and precise tracking on entire broadcast band. Single hole snap-in mounting, plus mounting bracket. Equally efficient at any angle. 2 1/4" x 7/16". Shpg. wt., 4 oz.
MS-11 In lots of 10, Each 36¢
Singly, Each 39¢

B. ENERGIZED FERRI-LOOPSTICK. New 5" ferrite rod loopstick antenna with a "Q" of up to 350. Extremely high gain brings in even distant stations not normally received. New type adjustable coil with self-locking vinyl collar permits peaking antenna for super sensitive results. 3/8" x 5". Shpg. wt., 6 oz.
MS-287 Net 88¢

C. 7" SUPER LOOP. Super sensitive ferrite loopstick antenna with a "Q" of up to 425. Excellent for replacement of old style loops. Brings in even hard to get stations with incomparable ease. Adjustable for maximum sensitivity over length of 7 in. Complete with mount. Shpg. wt., 6 oz.
MS-44 Net 1.32

SYLVANIA TRANSISTOR KIT



COMPLETE KIT 4.95

For The Experimenter

The Sylvania Transistor Kit is supplied with the Transistor Booklet "28 USES FOR JUNCTION TRANSISTORS," TWO Type 2N35 Transistors and one type 1N34A General Purpose Diode. Complete transistor circuits and detailed instructions make this kit easy to use. Ideal for the experimenter who wants to get the feel of transistorized circuits.

Complete Kit **4.95**

TRANSISTOR POTENTIOMETERS DIME SIZE



For Transistor and Sub-Miniature Circuits Versatile carbon controls for audio, tone and similar applications; specially designed for Transistor and Sub-miniature circuits. Only 3/4" diameter, Shaft 1" long 1/8" diameter. Shaft easily cut to desired length, includes nut and lock washer. Shpg. wt. 2 oz.

WITHOUT SWITCH

- VC-32 1,000 ohms VC-24 25,000 ohms
- VC-33 5,000 ohms VC-36 50,000 ohms
- VC-34 10,000 ohms VC-37 1/2 Meg
- VC-35 15,000 ohms VC-38 1 Meg
- MS-185—Miniature Knob 3/4" Diam.—Net 7¢

49¢

each

WITH S.P.S.T. SWITCH

These Versatile Sub-Miniature Controls with S.P.S.T. switch ratings 1 amp at 20 Volts, 1/4 amp at 67 1/2 volts. Control was especially designed for Transistor and Sub-Miniature applications: Bushing 1/4" diameter and 1/4" long, includes nut and lock washer. Only 3/4" diameter 33/64" deep, shaft 1/4" diameter, 1" long. Shaft can be cut to desired length.

- VC-26 1,000 ohms VC-25 25,000 ohms
- VC-27 5,000 ohms VC-31 50,000 ohms
- VC-28 10,000 ohms VC-39 1/2 Meg
- VC-29 15,000 ohms VC-40 1 Meg
- MS-186—Miniature Knob 3/4" Diam.—Net 7¢

69¢

each

GOLD INSERT PUSH-ON TUNING KNOB FOR VARIABLE CONDENSER



Attractive dark maroon plastic knob with gold insert. Fits 1/4" shafts such as MS-141, MS-142, MS-214 and MS-261. Fluted, tapered rim 1 3/8" diam. Back protrudes 3/16".

KN-18—Lots of 5, Each 16¢
Singly Each 18¢

MILLER TRANSISTOR I.F. TRANSFORMERS



These transformers have been designed for use with the Raytheon Transistor type CK760. They feature a tapped primary having an impedance near 25,000 ohms, and a secondary winding having an impedance near 600 ohms. 455 kc. Pri. 25 K Sec. 600. Size: 1/2" sq. x 3/4" high.

No. 2041 Net 1.62

MILLER TRANSISTOR LOOP ANTENNA



A fixed inductance loop with a large pickup field to insure adequate signal to the first stage. Inductor is tapped to match an input impedance of 600 ohms. Frequency range 540-1650 kc when used with a variable capacitor having a maximum capacity of 365 mmfd. Size: 1 1/4" x 9/16".

No. 2000 Loop Antenna Net 1.62

ATTENTION EXPERIMENTERS!

If you are interested in keeping up with the latest developments in transistor circuitry and components, get your name on Lafayette's special mailing list. You will receive these special brochures and releases regularly.

Just write Dept. TR-100

39¢ MINIATURE VOLUME CONTROL 3/4" DIAMETER

Only 3/4" diameter, overall depth approximately 4" including threaded shaft. Ideal for miniature radio, hearing aids, etc.

- VC-18—Range 0-500,000 audio taper 39¢
- VC-19—Range 0 to 1 Meg. linear taper 39¢
- VC-20—Range 0 to 3 Meg. audio taper 39¢

In Lots of 10—\$3.25



4 POSITION MINIATURE SWITCH 3/4" DIAMETER



35¢

SWITCH 3/4" DIAMETER

Has 4 positions, one marked OFF. Less than 1/2" deep including contact prongs. Self contained wheel type knob. Ideal for miniature radio, hearing aids for tone control switch, etc.

SP-88 Net .35
10 for 3.25

SUBMINIATURE 455 KC I.F.



89¢

ONLY 1/2" SQ

For vacuum tube type personal sets. Used in all the really small sets. Ferrite core, slug tuned from top and bottom of can. Can is only 1/2" square x 1 1/4" high. It's ideal for replacement as well as building miniature sets.

MS-129—in lots of 10, each .79
Singly, each .89¢

MINIATURE KNOB FOR 1/4" KNURLED SHAFTS



A truly miniature-sized dark maroon plastic knob designed to fit standard 1/4" knurled shafts. Ideal for mid-gate personal radios. Only 3/8" diam. x 3/8" high.

KN-19 In lots of 5, Each .06
Singly, Each .07

GENERAL REPLACEMENT KNOB



An attractively shaped, beautifully finished 1" diameter walnut plastic knob with setscrew to fit 1/4" round or flat shafts. Back of knob recessed to accommodate locknut.

KN-22 In lots of 5, Each .06
Singly, Each .07

MINIATURE AUDIO OUTPUT TRANSFORMER 39¢



• Weighs less than 1 oz.
• For Experimenters - Hearing Aids
• Only 7/8" H x 3/4" W x 3/8" D

Here's a high quality miniature output transformer that is ideal for use in hearing aids, and in a host of electronic applications where miniature electronic circuitry is used. Primary impedance is 30,000 ohms to match such tubes as CK506AX, CK524AX, etc. Low impedance secondary.

Shpg. wt., 2 oz.
TR-46— In lots of 10, each 39¢
Singly, each 49¢

DELUXE COIL WINDER WITH ACCESSORIES



4.95

Easy-to-use set winds honeycomb, spiderweb and solenoid coils of various widths and diameters—equal in appearance to a factory job. Also suitable for winding chokes, transformers and filter inductors. Indicator counts number of turns on coil. Supplied with accessories including wood spools, metal pegholders and extension for making long solenoid coils. Instructions included, but less coil forms and pegs. Wt. 6 lbs.

ML-43 4.95

MINIATURE AND SUB MINIATURE SPECIALTIES

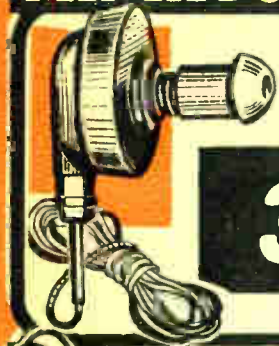

NEW! SUPER POWER DYNAMIC EARPHONE FOR TRANSISTOR CIRCUITS

3.95

SPECIAL HIGH OUTPUT-FOR LOW POWER CIRCUITS

Lafayette brings you the answer to the problem of the low output inherent in transistor circuits, where the power is so low you cannot afford to lose any of it. You'll be amazed at the difference in volume when you use this new dynamic earphone. Extra efficient construction with a powerful magnet gives up to 3 times the volume of other dynamic earphones, and at the same time gives you the quality of reproduction that is possible only with a dynamic unit. We've tried it on all kinds of transistorized circuits, and this remarkably efficient earphone preserved the precious power so well that in many cases the program was plainly heard with the earphone 2 feet away from the ear. It is not, of course, limited in use to low power devices — it will give superior performance wherever a high impedance dynamic earphone is required. AC impedance 8000 ohms, DC resistance 2000 ohms. Comes complete with 3 ft. detachable plug-in cord. MS-260 Net **3.95**



CRYSTAL EAR PHONE

Small, almost weightless, plastic ear phone with crystal element, that features high power and sensitivity. Ideal for all applications where a very high impedance unit is preferred. Fits comfortably in the ear. Complete with 3 ft. plastic covered cord.

CAN BE USED AS MICROPHONE

This unit is so powerful and sensitive that it can be used as a close-talking highly directional crystal microphone. Just screw off the ear-insert and your earphone becomes a mike to use for all sorts of experiments and gadgets.

MS-111 Net **1.49**

ALL-PURPOSE DYNAMIC EARPHONE

- FOR RADIO & TV LISTENING
- FOR SUBMINIATURE, MINIATURE & TRANSISTOR RECEIVERS



A sensitive all-purpose earphone designed for your listening pleasure. Combines the range of a dynamic earphone with the performance of its special magnet to give you excellent reproduction. Lightweight and equipped with ear support that slips comfortably over your ear. You can relax! The support is practically invisible — the earphone can't slip out — it can't fall off. Ideal for use with TV and radio sets, amplifiers, miniature and transistor receivers etc. Complete with 3 ft. cord. A super value for the price!

- MS-278 — 8000 ohm impedance, 1000 ohm DC resistance, with phone tip plugs Net **1.95**
- MS-277 — 8 ohm impedance, with phone tip plugs. For silent radio and TV listening or viewing Net **1.95**
- MS-273 — 3000 ohm impedance, 1000 ohms DC resistance, with sub-miniature phone plug and matching phone jack Net **2.39**
- MS-279 — 6 ohm impedance, with subminiature phone plug and matching phone jack. For silent radio & TV listening or viewing Net **2.39**

EARPHONE SUPPORT

A light, transparent plastic earphone support that fits comfortably around ear and is practically invisible. Earphone can't slip out nor fall off. Has 1/4" retaining hole for earphone. MS-268, MS-278, MS-277, MS-278 and MS-279. MS-280 Net **29¢**



NEW! GEM REMOTE CONTROL RELAY

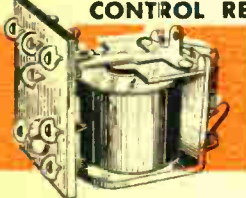

3.47

- The Mighty Mite of the R/C Field
- Weighs less than 1/2 oz!
- Size: 3/4" H, 17/32" W, 1-1/16" L

A natural for remote control receivers, it is highly sensitive, and built to withstand severe crashes. The smallest commercial job available, it weighs less than 1/2 oz. Factory adjusted to pull in at 1.4 MA, drop out at 1.2 MA D.C. Single pole, double throw. Used in outstanding R/C receivers. 5,000 ohm coil Net **3.47**

TELEX HEADSETS, EARSETS, SPEAKERS for Listening Comfort



TELEX MONOSET

Under-the-chin lightweight headset for individual listening. Reduces head fatigue. Removable white plastic ear plugs for easy cleaning. Magnetic type. Weighs 1.2 oz. Complete with 5 ft. cord and standard phone plug.

MODEL 4600 — 128 ohms List 12.50 Net 7.35
MODEL 4625 — 2000 ohms List 12.50 Net 7.35

TELEX CORD AND MINIATURE PLUG



5 ft. cord with 90° miniature plug. Shpg. wt., 5 oz.

MODEL 9200 List 3.15 Net 1.85

TELEX TWINSET

Banishes headachy ear pressure. Band rests on head and receivers set gently at temples; tubular sound arms pipe signal to ears. Only 1.6 oz. C.A.A. approved for pilots. Complete with 5 ft. cord and standard phone plug. Shpg. wt., 10 oz.

MODEL 3791 — 64 ohms List 18.25 Net 10.73



TELEX TELA-EAR

New miniature earphone that slips over either ear. A light, sanitary crystal-clear sound-shield transmits sound directly into the ear without touching it with a button receiver. Standard UN delegates earphone. Cannot fall or slide off. Sealed, rustproof receiver guarantees constant top performance. Complete with 5 ft. cord and standard phone plug. Shpg. wt., 8 oz.

MODEL 8560 — 128 ohms — List 12.50 Net 7.35
MODEL 8561 — 2000 ohms — List 12.50 Net 7.35



TELEX HI-FI DYNASET

Sensitive Hi Fi under-the-chin dynamic headset. 50-8000 cycle response to 25 MW. Midget 3/4" 6-ohm speaker built right into the plug. Light gray finish. Shpg. wt., 6 oz.

MODEL 6791 — 6 ohms — Complete List 14.75 Net 8.67



TELEX DYNAMIC PILLOW SPEAKER



New dynamic miniature pillow speaker gives ultimate in tonal quality without distortion. For individual and institutional use. Stainless steel, moisture proof housing. Size: 3 3/4" dia., 1 1/2" max. thickness. With 5 ft. cord and standard phone plug. Shpg. wt., 8 oz.

MODEL 8110 — 3.0 ohm List 10.20 Net 6.00
MODEL 8130 — 10,000 ohm List 12.10 Net 7.11

TELEX MIDGET EARSET



The modern miniature earphone that slips on the ear. Convenient and comfortable to wear and holds receiver securely in place. 200 to 10,000 cycles frequency response. Reversible clear plastic frame fits either ear. Metal frame unit available for eyeglass wearers. Weight 1/2 oz. less cord. Complete with 5 ft. cord and standard phone plug. Shpg. wt., 7 oz.

MODEL 4680 — 2000 ohms — Plastic }
MODEL 4670 — 128 ohms — Plastic } List 11.30, Net 6.64
MODEL 9335 — 1000 ohms — Metal }
MODEL 9334 — 128 ohms — Metal }



TELEX PILLOW SPEAKER



Only 2 1/4" diameter and only 3/4" thick! Ideal for comfortable radio or television listening through a pillow in bed or in a chair without disturbing others. Maroon waterproof plastic. Complete with 5 ft. cord and standard phone plug. Shpg. wt., 8 oz.

MODEL 4500 — 128 ohms List 10.70 Net 6.29
MODEL 4530 — 2000 ohms List 10.70 Net 6.29

PRINTED CIRCUITS • MINIATURE PARTS

MAKE YOUR OWN PRINTED CIRCUITS



27.00

- IDEAL FOR LABORATORY WORK TO MAKE PROTOTYPES
- FOR THE BUILDER — EXPERIMENTER — STUDENT — TECHNICIAN

Printed circuits are designed to eliminate wiring and are ideal for space saving, particularly where miniature components are used. They are being used widely in an ever increasing number of applications. With these kits, you can etch your own circuitry on copper clad XXXP insulating boards with etching materials provided. Kits also contain variety of other materials and parts such as printed circuit sockets, various types of resist-material, etc. Listing below gives contents. All in handsome plastic box.

KIT NO. 5004P

Contains 12 copper clad boards in sizes from 9" x 12" to 2 1/2" x 3", 3 of which are clad on both sides; 10 assorted 7 and 9 pin miniature printed circuit sockets; 1 gold-plated, beryllium-copper 10 contact connector; 5 packs etchant solution; 1 tape resist 1 1/8" wide; 1 bottle liquid resist; 1 photo sensitive emulsion developer and dye; 5 dozen assorted brass eyelets; 1 carbon steel drill. In plastic box size 13 1/2 x 9 x 2 1/2. Shpg. wt. 5 lbs.

Net 27.00

KIT NO. 5003P

Contains 8 copper clad single faced and 2 double faced boards from 4 1/2" x 8" to 3" x 2 1/2"; 6 tube sockets; 2 packs etchant; 1 tape resist; 1 liquid resist; 3 dozen eyelets; 1 drill and typical circuit diagrams and directions.

Net 9.75

KIT NO. 5001P

A road kit to start off learning the technique of etched circuitry. Contains 3 copper clad boards from 4 1/2" x 3" to 3" x 2 1/2"; 1 each 7 and 9 pin sockets; 1 pack etchant; 1 tape resist; eyelet assortment; drill and directions.

Net 3.75

PRINTED CIRCUIT SERVICE KIT



Here's a kit every serviceman needs to repair printed circuits or printed wiring in TV sets, hearing aids, radios, etc. Contains Print-Kote Silicon Resin, solvent, pure silver print, solder probe tool, Print-Kote solder, stainless brush and scraper and printed circuit service manual. Shpg. Wt. 2 lbs.

GC-680 Kit

Net 5.73

ECONOMY KIT

Same as above but less the pure silver print.

GC-681 Kit

Net 3.41

PRINTED CIRCUIT ESSENTIALS



PRINT-KOTE SILICON RESIN. Used to coat and protect joints and parts after repair. Fast, air drying 2 oz. bottle with brush.

GC-14-2..... Net 1.15

PRINT-KOTE SOLVENT. For removing silicon resin or to thin it. 2 oz. bottle.

GC-13-2..... Net .32

PRINT-KOTE SOLDER. Non-corrosive flux with low melting solder combined with pure silver. 2 oz. coll.

GC-9131..... Net .44

PRINT-KOTE SILVER PRINT. Pure silver compound air drying. Used to repair printed circuit "wires" and touch up connections. 1/2 Troy oz.

GC-21-1..... Net 2.13

SOLDER-AID PROBE. Special fine point. Stainless steel. Solder won't stick.

GC-9093..... Net .97

BRUSH AND SCRAPER. Stainless steel brush and steel scraper. Indispensable repair tool for printed circuits.

GC-9094..... Net .97

AMPHENOL PRINTED CIRCUIT CONNECTORS



Molded of Blue dielectric. High impact and tensile strength, low moisture absorption, high dielectric strength and high arc resistance. Width 1/8" less than 1/4" high. Ideal for termination of circuitry on printed boards. With standard contact.

Amphenol No.	No. of Contacts	Mfg. Ctrs.	Net EoCh
143-010-01	10	2.11"	1.70
143-015-01	15	2.93"	1.81
143-018-01	18	3.40"	1.96
143-022-01	22	4.03"	2.19

PRINTED CIRCUIT SOCKETS FOR TRANSISTORS



7 contact. For use with Raytheon CK721-722 and similar types. Size 1 3/32" x 17/64" x 1/4".

MS-149..... 22c

FOR MINIATURE TUBES

Phenolic miniature sockets for printed and etched circuits. Rapid mount with snap action contacts to secure socket.

MS-150 - 7 PIN..... Net 13c

MS-151 - 9 PIN..... Net 20c

CENTRALAB PRINTED ELECTRONIC CIRCUITS (PEC)

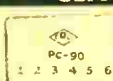

Ideal for the replacement of entire circuit sections in radio and TV. You reduce wiring time as well as considerable troubleshooting time required to locate individual faulty parts. These low-cost PEC units are complete printed electronic circuits composed of resistors, capacitors, and in some cases, inductance. They are extremely stable since the wiring and all components are bound to a ceramic base and sealed against moisture, temperature variations, and physical shock. These dependable and highly efficient PEC units will save you time and cut replacement costs materially.

NEW PRINTED CIRCUIT NO. 3 - PEC replacement guide for radio and TV sets listed by 119 manufacturers **FREE** when requested with your next order.

PRINTED CIRCUIT UNITS

NO.	DESCRIPTION	EACH	NO.	DESCRIPTION	EACH	NO.	DESCRIPTION	EACH
PC-50	Filipee	.35	PC-92	Pentode Couplate	.59	PC-189	Audet Output Stage	.68
PC-51	Filipee	.35	PC-100	Vertical Integrator	.65	PC-160	Pendet	.73
PC-52	Filipee	.35	PC-101	Vertical Integrator	.73	PC-165	Pendet	.79
PC-60	Resistor-Capacitor	.29	PC-104	Vertical Integrator	.65	PC-176	Plate for GE K82J45*	.44
PC-61	Resistor-Capacitor	.29	PC-105	Vertical Integrator	.65	PC-177	Plate for Admiral 63R6-B	.59
PC-70	Triode Couplate	.41	PC-106	Vertical Integrator	.59	PC-178	Plate for Admiral 63B6-4	.44
PC-71	Triode Couplate	.44	PC-110	Filplate	.44	PC-179	Plate for Capellari 47226A	.83
PC-80	Triode Couplate	.44	PC-111	Filplate	.44	PC-260	Syne Takeoff Couplate	.73
PC-81	Triode Couplate	.44	PC-150	Audet Output Stage	.59	PC-262	Syne Takeoff Couplate	.73
PC-82	Special	.44	PC-151	Audet Output Stage	.68	PC-263	Syne Takeoff Couplate	.73
PC-84	Triode Couplate	.44	PC-154	Audet Output Stage	.59			
PC-90	Pentode Couplate	.53	PC-157	Audet Output Stage	.59			
PC-91	Pentode Couplate	.53	PC-158	Audet Output Stage	.68			

INSULATED BANANA JACKS-PLUGS

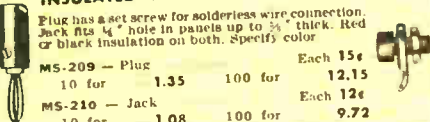

Plug has a set screw for solderless wire connection. Jack fits 1/4" hole in panels up to 3/8" thick. Red or black insulation on both. Specify color.

MS-209 - Plug..... Each 15c

10 for 1.35 100 for 12.15

MS-210 - Jack..... Each 12c

10 for 1.08 100 for 9.72

SOLDERLESS INSULATED PHONE TIP PLUGS

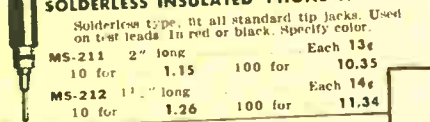

Solderless type, fit all standard tip jacks. Used on test leads. In red or black. Specify color.

MS-211 2" long..... Each 13c

10 for 1.15 100 for 10.35

MS-212 1 1/2" long..... Each 14c

10 for 1.26 100 for 11.34

INSULATED TIP JACKS

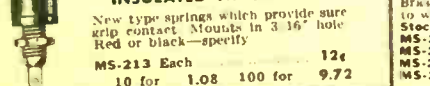

New type springs which provide sure grip contact. Mounts in 3/16" hole. Red or black - specify.

MS-213 Each..... 12c

10 for 1.08 100 for 9.72

CINCH-JONES "2000" TERMINAL STRIPS



Compact and sturdy bakelite junction terminal strip. Useful in assembling radio chassis, wiring, etc. Steel cadmium plated brass brackets. Terminals spaced on 5, 10, 15 centers.

No.	Term.	Mfg. Ctrs.	Each
2002	2	1"	.05
2003	3	1 1/2 16"	.06
2004	4	1 1/2 16"	.07
2005	5	1 1/2 16"	.07
2006	6	2 7/8 16"	.08
2007	7	2 7/8 16"	.08
2008	8	3 1/2 16"	.09
2009	9	3 1/2 16"	.09
2010	10	3 1/2 16"	.10
2011	11	3 1/2 16"	.10
2012	12	4 1/2 16"	.11
2013	13	4 1/2 16"	.11

FAHNESTOCK CLIPS

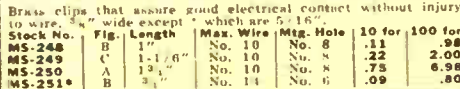

Brass clips that assure good electrical contact without injury to wire. 3/8" wide except " which are 5/16".

Stock No.	Fig.	Length	Max. Wire	Mfg. Hole	10 for	100 for
MS-248	B	1"	No. 10	No. 8	.11	9.8
MS-249	C	1 1/8"	No. 10	No. 8	.22	2.00
MS-250	A	1 1/8"	No. 10	No. 8	.75	6.98
MS-251*	B	3/4"	No. 14	No. 6	.09	.80

GOLD INSERT KNOBS

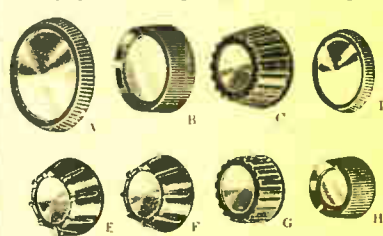

Attractive, modern-shaped knobs for replacement purposes, molded of high-quality plastic and beautifully finished. All with rich-looking gold insert. Avg. shpg. wt. 2 oz.

SET SCREW TYPE

Fit round or flat 3/4" shafts. All have concave polished gold inserts. * Indicates back of knob recessed 1/8" others flush.

Stock No.	Fig.	Diam.	Color	Net Ea.	5 or More Ea.
KN12*	C	1 1/4"	Malogany	.15	.12
KN13*	F	1 1/4"	Malogany	.15	.12
KN14	G	1 1/4"	Malogany	.15	.12

PUSH-ON TYPE

Fit flat 3/4" shafts. * Indicates convex gold insert and back of knob protrudes 3/16". Others have flat gold insert and flush back.

KN15	B	1 1/4"	Dark Malogany	.15	.12
KN16*	D	1 1/4"	Dark Malogany	.15	.12
KN17*	D	1 1/4"	Dark Malogany	.15	.12
KN18*	A	1 1/4"	Dark Malogany	.18	.16
KN20	H	7/8"	Black	.12	.10

POINTER TYPE

This knob has a gold pointer and polished gold concave insert. Fits 1 1/4" flat shaft.

KN21	E	1 1/4"	Black	.17	.15
------	---	--------	-------	-----	-----

LAFAYETTE

Leads the Field in
TRANSISTORS

Circuits Kits & Components



Another Lafayette First!



SUBMINIATURE PHONE PLUG AND JACK

Latest and tiniest phone plug and jack available. Only 1" long x 3/16" diameter, overall. Highest quality styling and construction. Excellent for applications. Plug has removable sleeve. Jack can be mounted on panel up to 1/16" thick. Jack can be used for both open and closed circuits.

MS-281—Plug Net 22¢
MS-282—Jack Net 17¢

STANDARD PIEZO CDS-3 CADMIUM SULPHIDE PHOTOCELL

A miniature crystal photocell that is ideal for counting, activating and measuring applications. Rapid response—fast enough to operate the fastest relay. Resistance change response is proportional to light—highly linear from 1 ft. candle to 0.001 ft. candle permitting delicate measurements involving minute changes in light intensity. For light interruption applications, intensities as high as 150 ft. candles are usable. Min. current output 1.5 ma at 80 ft. candles and 90VDC with 10,000 ohm load. Dark current less than .2 ma at 90VDC. Max. dissipation 150 mw. Max. volt. 200V peak.

CDS-3 Photocell..... 3.60

NEW! CLAIREX CRYSTAL PHOTOCELL TYPE CL-2

The latest version of this famous cadmium sulphide crystal features greater stability, greater sensitivity at low voltages, lower noise level and longer life. Highly pure cadmium sulphide crystal extremely sensitive to light over the entire visible spectrum, with maximum response near green portion, with exceptional response in near infra red, and X rays and gamma rays. High output voltage and relatively high output current. Will operate a meter, a relay, neon lamp, cold cathode gas tube, to full output at low frequencies. Ideal for constructing exposure meter, for quick relay action, etc. Sensitivity in candles is 100 ua at 100V and 2 ft. ua at 1V it is 1 ua. Dark current .05 source. Maximum voltage 250-V AC or DC. Size 1/4" x 1/2" long.

CLAIREX-CL-2..... Net 3.50

MINI-MIKE® TELEX SPEAKER-MICROPHONE



DYNAMIC SPEAKER-MICROPHONE

Truly an outstanding addition to the famous Telex line of miniature electronic equipment and parts. The new dynamic speaker-microphone Model 100 may be used as a speaker or a microphone and is only 1 x 1 x 3/4" in size. The advantages of miniaturization are amazingly combined with sensitivity and high quality dynamic performance.

Perfect for use in dictating machines, portable radio transceivers and other electronic equipment requiring super-small size transmitting-receiving units. The Mini-Mike has available a miniature external transformer for matching the microphone to grid circuits. Rugged construction throughout assures long-lasting dependability.

Sensitivity—microphone with transformer: 62 db below 1 volt per dyne per sq. cm.; speaker: 124 db below 10 milliwatts of power input. Impedance—10 ohms. Construction—Weight 1 1/2 oz.; Size 1 x 1 x 3/4". Tough thermo-setting plastic and steel case.

Complete Unit—Port No. 9155—10 ohms Net 4.50
A miniature external transformer miniature—Size 1 1/16" x 5/16" x 1/2"—is available at extra cost for matching Speaker-Microphone Model 100 to grid circuits. No. 8919 Net 2.28

B2M SUN BATTERY



International Rectifier's Sun Battery requires no external voltage source for operation. Average sun-light will generate a 2 ma current under a 10 ohm load. Can be connected directly to a milliammeter and used as a light measuring device. Can be used in series or series-parallel as a power supply for transistorized equipment. Typical applications are—direct conversion of light to electricity—spectrophotometers—light measurement—traffic control—headlight dimmer—burglar alarms—timers—colorimeters—garage door opener—light beam communication. Specifications: 724" x 443" x .040" 80 micro amps at 100 ft. candles with 55 ohm load. 5 volt in average sun-light. 25 volts at 100 ft. candles. Complete with 1/2" ms. bracket and 6" leads.

MS-112..... Net 1.47

NEW!



TINY PLUG AND JACK

Lafayette is first to bring you this miniature plug and jack combination. Ideal as input and output terminal in transistor and subminiature receivers, hearing aids, etc. Extremely small convenient phenolic plug 13/32" dia. 3/16" long. Socket has two 3/32" mounting holes. A super value combination.

MS-283—Plug Net 12¢
MS-284—Jack Net 10¢
MS-285, 2 plug jack—1 1/4" long, 3/4" wide Net 12¢

27/32" long, overall. Matching flat bakelite socket 3/16" dia. 3/16" long, 7/16" wide, 1/8" thick. Socket has two 3/32" mounting holes. A super value combination.

SELENIUM PHOTOCELL 11.03

Barrier layer, self-generating type; light striking upon cell generates current sufficient to operate relays directly without the use of auxiliary power. Lifetime of cell is unlimited. 600 microamperes of output at 100 foot candles. 2 inches in diameter. Mounted in a handsome plastic case.

MS-152—Photocell—Wt. 8 oz. 11.03

NATIONAL FABRICATED LIFETIME SILICON SOLAR CELL



The first device to convert useful amounts of the sun's energy directly and efficiently into electricity. Conversion efficiency remains essentially constant even in poor light. Measures up to 0.5 volt on open circuit under direct noon sunlight, and converts solar energy to electrical power at a rate up to 10 mw. Permanent life-time p-n junction. Will operate on infra-red light. Only 1 3/4" dia. x 3/16" thick. Shpg. wt. 4 oz.

Type S-1..... Net 20.00

PERFORATED BAKELITE BOARD FOR TRANSISTOR AND SUBMINIATURE CIRCUITRY

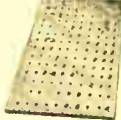

Ideal base for mounting transistors and subminiature parts for builders and experimenters. Sturdy, high grade bakelite 3-7/16" x 2 1/2" x 1/16" thick, with 1/8" clearance between holes. For contacts see MS-263 clips below.

MS-262..... Net .19

TELEX MINIATURE PHONE PLUG AND JACK



TELEX NO. 9231—PLUG..... .35
TELEX NO. 8570—JACK (Closed Circuit)..... .24
TELEX NO. 9240—JACK (Open Circuit)..... .24

1/3 the size of previous small plug and jacks, yet with all the quality of precision workmanship. Plug is 1-7/32" long by 1/8" diameter. Jack can be mounted on any panel up to 1/8" thick.



SHURE 1 INCH MIKE

Specially designed for miniature "build it yourself" equipment, transistor-type devices, hearing aids, etc. Controlled reluctance type. Output level—71 db. Impedance 1000 ohms. Heat-humidity—shock proof. Muv metal shield. 1" diameter.

SHURE MC-11..... NET 7.35

NEW! SHURE 1 INCH RECTANGULAR MIKE



Experimenters' delight! 1" rectangular controlled-reluctance microphone. Ideal for transistor hearing aids, amplifiers, etc. 1100 ohms impedance; output level—75 db. Resistant to heat, humidity; shock proof.

SHURE MC-20..... Net 7.35

THE USE OF SELENIUM PHOTOCELLS AND SUN BATTERIES



The first handbook and guide on Photocells and Sun Batteries for kit builders, experimenters, technicians and engineers. Contains charts, specifications, diagrams, and Sun Batteries and their application. 74 Pages Illustrated 6" x 9"..... 1.50

Write for FREE Reprint of "BUILD A SOLAR-POWERED RADIO."

TRANSISTOR SINE-WAVE GENERATOR KIT



Reliable, compact transistorized test instrument! The pocket-sized audio signal generator! This generator can be a valuable test instrument in the hands of the experimenter or technician. With it he can service and check operation of P.A. systems, phonograph amplifiers, intercom systems and the audio section of auto wts., home radios and portables, size 3 1/4" x 2 1/2" x 1 1/2". Shpg. cabinet, condensers, resistors, transformer etc. schematic diagram.

KT-83..... Net 8.75

PLASTIC CASES FOR MINIATURE ELECTRONIC GEAR



They're here! The miniature cases you've been clamoring for! Perfect for transistors, sub-miniature and miniature amplifier, etc. housing. Sturdy polystyrene cases, printed circuit, ball-type hinge that permits removal of partitions. New! Facilitate inspection and servicing. Removable covers without hinge. Hinged cover not removable.

STOCK NO.	SIZE L x W x H	NET	STOCK NO.	SIZE L x W x H	NET
MS-156	1 3/8 x 2 1/2 x 1 1/2"	.09	MS-161	4 3/8 x 2 3/4 x 1"	.30
MS-157	2 3/8 x 1-3/16 x 1"	.12	MS-162	4-1/8 x 1 1/2 x 3-9/16 x 1 1/4"	.32
MS-158	2 1/2 x 2 x 1"	.15	MS-163	5 x 5 1/4 x 1-5/16"	.35
MS-159	3 3/8 x 2 3/8 x 1"	.18	MS-164	5 3/4 x 3 x 1-3/16"	.22
MS-160	4 3/8 x 2 3/8 x 3/4"	.20			

NEW!
Revolutionary
Design

**2-GANG
SUPER-HET
Variable
Condenser**

Argonne
"POLY-VARI-CON"

THE SMALLEST VARIABLE CONDENSER IN THE WORLD



**365 MMF SINGLE GANG
SUPER-MIDGET
VARIABLE CONDENSER**

The newest and one of the finest single gang variable condensers on the market. Designed to give exceptional performance in TRF and experimental circuitry. 10 to 365 mmf single gang. Tunes through 180°. Completely enclosed in plastic case. $\frac{5}{8}$ " x $1\frac{1}{16}$ " x $1\frac{1}{16}$ "

MS-274

Net 1.25



1.95

Lafayette does it again with this new super 2 gang midget variable condenser. An exciting and proven innovation in the transistor parts field. Manufactured for top performance in transistor super-het circuits, it measures only $\frac{5}{8}$ " x $1\frac{1}{16}$ " x $1\frac{1}{16}$ ". Has 2 gangs specifically designed for transistor super-hets — 10 to 208 mmf capacitance on the antenna section, and 10 to 100 mmf on the cut oscillator section. Self contained trimmers. Tunes through 180°. Entirely enclosed in a transparent plastic case! The smallest complete 2 gang variable for super-hets in the world! Offers unlimited possibilities to the experimenter.

Net 1.95

**TRANSISTOR SUPER-HET
LOOP ANTENNA**



The latest transistor loop antenna especially designed to match the input impedance of the RF stage in transistor super-het circuits. Requires maximum capacity of 208 mmf in RF section of variable condenser. Matched with the New Super Midget 2 gang variable condenser, MS-270 to give excellent sensitivity and selectivity through the entire broadcast band of 540-1650 kc. Wound on high efficiency iron core $\frac{3}{16}$ " dia. x $\frac{1}{4}$ " dia.

MS-272—Ant. Coil

Each, Net .95

**TRANSISTOR
OSCILLATOR
COIL**



For 455KC IF circuits. Matches MS-270 variable condenser when used with MS272 ant. loop; matches MS-261 variable cond. with MS264 ant. loop. Size $\frac{3}{8}$ " x $\frac{1}{2}$ "

MS-265 In lots of 6, Ea. 69¢
Singly, Each 79¢

MATCHED TRANSISTOR 455 KC I.F.'S

*FERRITE CORE—SLUG TUNED *ONLY $\frac{1}{2}$ " SQ. x $\frac{3}{4}$ " H

Products of the latest engineering research, these 455 KC transistor I.F. transformers are designed with improved ratios of primary to secondary turns and of capacity to inductance for perfect impedance matching. Extensive research has proven that matching 1st and 2nd I.F.'s having a primary impedance of 25,000 ohms and a secondary impedance of 600 ohms with a 3rd I.F. having a primary impedance of 25,000 ohms and a secondary impedance of 1,000 ohms gives vastly improved results in transistor super-het circuits. Lafayette is first to make these specially matched transistor 455 KC I.F. transformers available to you!

MS-268 1st and 2nd I.F. primary impedance 25,000 ohms, secondary 600 ohms .89
MS-269 3rd I.F. primary impedance 25,000 ohms, secondary 1,000 ohms .89



VARIABLE CONDENSERS

MIDGET 2 GANG SUPER

2 gang. Front section 17 plates with capacity of 305 mmf to 365 mmf; rear section plates with capacity of 70 mmf to 132 mmf. Individual trimmers on each section. End plates of RF section slotted for easy tracking. 180° rotation. Capacity increases counter clockwise. $1\frac{1}{4}$ " diam. brass shaft, mounted on ball-bearing, extends $1\frac{1}{2}$ " from cadmium plated steel frame. Frame size: $1\frac{1}{2}$ " x $1\frac{1}{2}$ " D x $1\frac{1}{2}$ " W x $1\frac{1}{2}$ " H. Standard mounting holes front and rear. Brass contact wiper. For superhet circuits with 455 KC IF. Shpg. wt. 10 oz.

MS-141

Net 98¢

2 GANG TRF

Same construction as above but each gang has 23 plates. Maximum capacity each section 365.7 mmf, minimum 10.3 mmf. Frame size 2-3/16" D x 1-13/16" W x 1-3/8" H. Shpg. wt., 10 oz.

MS-142

Net 98¢

MIDGET 1 GANG TRF

Similar in construction to above but single gang with capacity from 10 to 365 mmf. Size 1-3/16" D x 1-5/16" H x 1-3/8" W.

MS-214

Net 73¢

**TRANSISTOR MINIATURE 2 GANG
SUPER-HET VARIABLE CONDENSER**

ONLY $1\frac{1}{2}$ " x $1\frac{1}{8}$ " x $1\frac{1}{8}$ "

All the new miniaturized transistor operated sets such as GE, Regency, etc., are using this truly miniature 2 gang variable. Lightweight — both the frame and plates are aluminum. Smooth ball bearing action over entire 180° rotation. Bakelite stator insulation. Capacity of 11 plate R.F. section is 6.3 to 123.1 mmf; 9 plate oscillator section is 5.7 to 78.2 mmf. Effective range of trimmer is 15 mmf. These add 2 mmf to minimum capacity. Capacity increases in counter clockwise direction. Flatted shaft, $\frac{1}{16}$ " diameter by $1\frac{1}{4}$ " long. Frame size only $1\frac{1}{2}$ " D x $1\frac{1}{8}$ " W x $1\frac{1}{8}$ " H. Shpg. wt 5 oz.

MS-261

Net .95

TRANSISTOR LOOP ANTENNA AND OSC. COIL



MS-264

A loop antenna with a primary inductance of 700 microhenrys, especially designed with the proper tap to match the input impedance required in transistor circuits. Covers the entire broadcast band from 540-1650 KC when used with latest miniature type variable condensers such as used in GE, Regency and other miniature sets. (Lafayette MS-261 is ideal). Requires maximum capacity of 123 mmf in RF section of variable condenser. Wound on high efficiency iron core $\frac{1}{4}$ " long x $\frac{1}{4}$ " diam.

MS-264 Net .95

In lots of 6, Each .89

MS-265 Matching Oscillator Coil.

In lots of 6, Each 69¢ Singly, Each 79¢



MS-265

MATCHED SET

**TRANSISTOR ANTENNA LOOP AND OSC. COIL
FOR USE WITH 365 MMF CONDS. SUCH AS MS142**



A Transistor Loop Antenna with a fixed inductive loop; specially designed with $\frac{1}{16}$ " diameter Ferrite Rod to insure adequate signal to the first stage. Inductor is tapped to match an input impedance of 600 ohms. Frequency range, 540-1650 Kc. when used with variable condenser having a maximum capacity of 365 mmf. Dimensions $9\frac{1}{16}$ " x $4\frac{1}{8}$ ".

MS-166

NET 1.25

OSCILLATOR COIL

Designed for transistor circuits to supply the local oscillator energy to mixer stage. Intermediate frequency 455 Kc. Used with a variable condenser maximum capacity of 365 mmf. Mounting clip fits into $\frac{3}{16}$ " diameter hole. Dimensions $\frac{5}{8}$ " x $1\frac{1}{4}$ " high.

MS-165

Net 69¢

**MINIATURE 365 mmf
VARIABLE COND.**

* ONLY $\frac{3}{16}$ " Thick

A new type of variable condenser that is ideal for the builder of transistorized and miniature equipment. Capacity variable from 7.0 to 365 mmf. Single gang, measures only $\frac{3}{16}$ " thick x $1\frac{1}{16}$ " square. Bushing and shaft extend $\frac{7}{16}$ ". 180° rotation.

MS-215

Net 69¢



69¢



100%
SUBMINIATURIZED

6 TRANSISTOR SUPER HET CIRCUIT

WITH CLASS "B" PUSH PULL AMPLIFICATION



BUILD A 6 TRANSISTOR SUPER HET RECEIVER

- 100% SUBMINIATURE PARTS—NO COMPROMISES!
- LABORATORY DESIGNED—SENSITIVE, SELECTIVE, STABLE!
- CLASS B PUSH-PULL AMPLIFICATION—PLENTY OF POWER!

This circuit has been especially developed for the experimenter and engineer who wants a set of really commercial quality. To make it possible, Lafayette has made available all the heretofore impossible to find subminiature electronic parts. The circuit uses 3 RF Transistors, 3 Audio Transistors, a crystal diode and features specially matched set of 3 I.F.'s, Oscillator, High Q Loop, Class B P.P. Audio Amplification, Transformer Coupling in Audio and output stages. Special care has been taken in the design for exact impedance matching throughout to assure maximum transfer of power. We supply all the basic electronic components, leaving chassis and cabinet and physical layout to your ingenuity.

COMPLETE LIST OF PARTS — LESS CHASSIS AND CASE

ALL PARTS MAY BE PURCHASED INDIVIDUALLY

QUANT.	STOCK NO.	DESCRIPTION	NET EA.	TOTAL	QUANT.	STOCK NO.	DESCRIPTION	NET EA.	TOTAL
1	MS-270*	Variable Condenser	1.95	1.95	1	CF-122	10 mfd 15V Cond. ELECT.	.33	.33
2	MS-268	1st & 2nd I.F.	.89	1.78	1	CF-126	100 mfd 15V Cond. "	.45	.45
1	MS-269	3rd I.F.	.89	.89	1	CF-120	2 mfd 15V Cond. "	.29	.29
1	MS-265	Oscillator Coil	.79	.79	1	CF-103	10 mfd 6V Cond. "	.29	.29
1	MS-272*	Antenna Coil	.95	.95	1	X-1060	.05 mfd Paper Cond.	.29	.29
2	2N135	G.E. Transistor	2.70	5.40	1	MS-173	Battery Holder	.20	.20
1	2N-136	G.E. Transistor	3.10	3.10	1	VS-300	9 Volt Battery	.94	.94
3	2N107	G.E. Transistor	1.25	3.75	3	CJ-55A	5 Lug Terminal Strips	.06	.18
1	1N64	G.E. Diode	.50	.50	1	5206A	12 Ohm 1/2 Watt Res.	.05	.05
6	MS-275	Transistor Sockets	.19	1.14	1	5206A	68 Ohm 1/2 Watt Res.	.05	.05
1	AR-109	Driver Transformer	2.95	2.95	1	5206A	330 Ohm 1/2 Watt Res.	.05	.05
1	AR-120	Output Transformers, 10-12 Ohm Sec.	2.95	2.95	2	5206A	1000 Ohm 1/2 Watt Res.	.05	.10
1	SK-39	RCA 2 3/4" Speaker, 12 Ohm Voice Coil	1.79	1.79	2	5206A	2200 Ohm 1/2 Watt Res.	.05	.10
1	VC-27	Min. Pot with Switch	.69	.69	1	5206A	3300 Ohm 1/2 Watt Res.	.05	.05
1	MS-186	Min. Knob for V.C.	.07	.07	2	5206A	4700 Ohm 1/2 Watt Res.	.05	.10
7	C-601	.01 Ceramic Disc	.09	.63	1	5206A	6800 Ohm 1/2 Watt Res.	.05	.05
2	C-601	.005 Ceramic Disc.	.09	.18	1	5206A	27,000 Ohm 1/2 Watt Res.	.05	.05
2	C-601	5 mmf Ceramic Disc.	.09	.18	2	5206A	33,000 Ohm 1/2 Watt Res.	.05	.10
					1	5206A	47,000 Ohm 1/2 Watt Res.	.05	.05
					2	5206A	100,000 Ohm 1/2 Watt Res.	.05	.10

Complete List of Parts as listed above for 6 Transistor Super Het Circuit.

CI-100

Net 33.56

*Alternate Components

MS-261 Variable Condenser (.95) and Matching Loop Antenna MS-264 (.95).

If you desire to use a speaker with 3.2 ohm voice coil, use AR-119 output transformer instead of AR-120

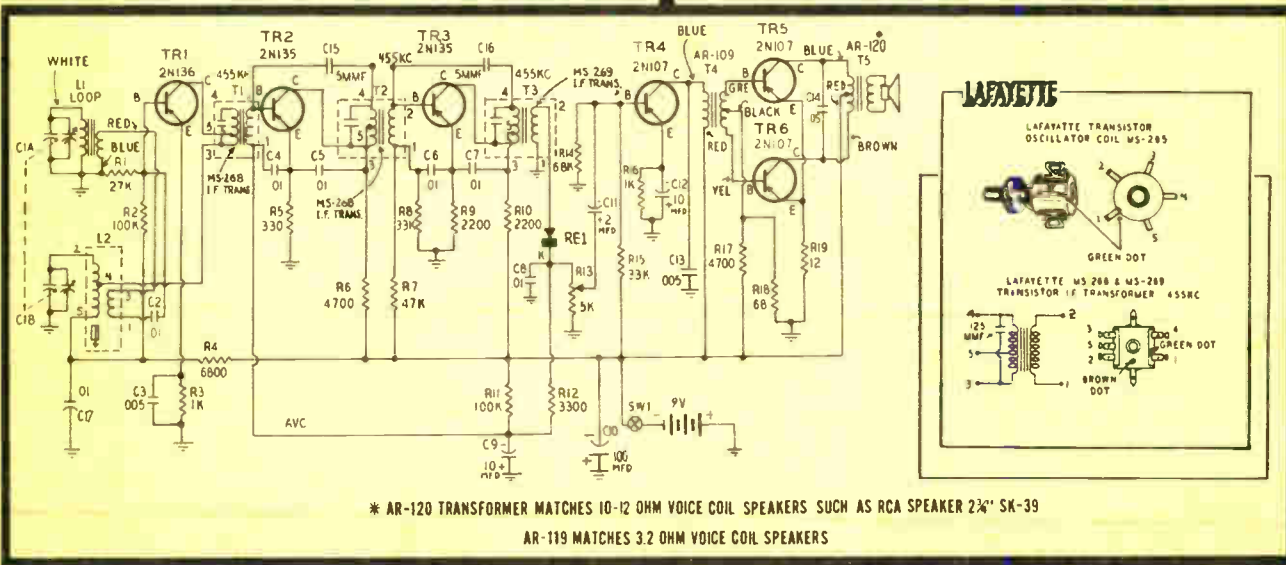

TRANSISTOR

Circuits & Kits



TWO TRANSISTOR POCKET RADIO RECEIVER KIT

With Regenerative Circuit and Transistor Transformer Audio Stage



11.80

LESS EARPHONE

Packed Into a 2 1/2" x 3 1/2" x 1 1/4" Plastic Case, this Two Transistor Radio Receiver Kit offers many surprises. Regeneration "Soups Up" the performance of transistor Receivers. Simple transistor radios without regeneration are just crystal detectors followed by audio amplification and there is no R.F. amplification, and sensitivity and selectivity are always poor. In contrast With This, this Lafayette Kit, KT-68, utilizing a regenerative detector circuit and one stage of transformer coupled audio, gives you high gain and sharp selectivity. In the wee hours, you may pull in stations halfway around the country. At the beach, on picnics or camping trips, the set will deliver almost any station on the dial, with more than ample volume. It has more battery life than you would dream of getting from a tiny 15 volt battery. The kit comes complete, with TWO TRANSISTORS, Argonne specially designed Transistor Audio Transformer, Dynamic Earphones, Bakelite Board for mounting parts, Transparent Plastic Case, Condensers, Resistors, etc., including Schematic and instructions. Shpg. Wt. 1 1/2 lbs.

KT-68A—Complete kit with batteries but less earphone. Net **11.80**
 KT-68—as above but with MS111 crystal earphone. Net **13.30**
 MS-260—Super power, high output dynamic earphone for optimum results. Net **3.95**

TRANSISTOR CODE PRACTICE OSCILLATOR KIT

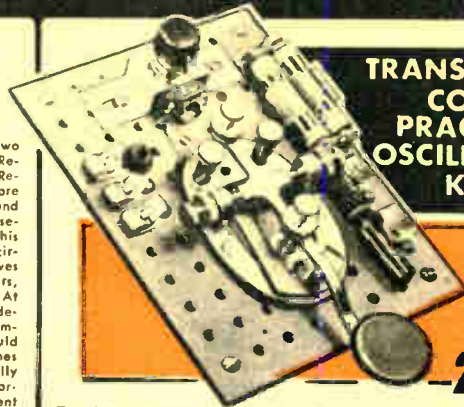

2.99

For those interested in mastering the international code, an audio tone oscillator is essential. The circuit of this transistorized feedback oscillator has the simplicity of the neon glow, the signal strength of the vacuum tube, and requires only two penlite cells for weeks of service. It may be used for solo practice, or two may send and receive with the same unit. Kit comes complete with Transistor, Telegraph Key, Resistors, Condensers, Masonite Board, etc., and Schematic Diagram. KT-72 Including batteries Shpg. Wt. 1 1/2 lbs. Net **2.99**
 Carmon ECI—Single Headset Net **1.13**

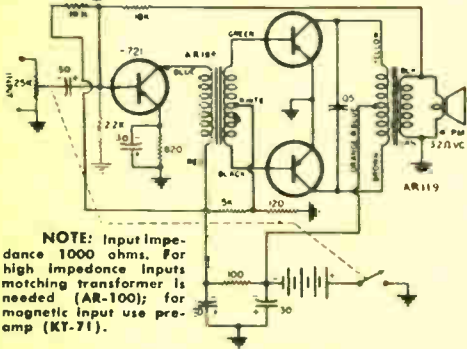

NOTE: Input impedance 1000 ohms. For high impedance inputs matching transformer is needed (AR-100); for magnetic input use pre-amp (KT-71).

TRANSISTOR AUDIO AMPLIFIER

for SPEAKER OPERATION CLASS "B" PUSH PULL TRANSFORMER COUPLED 1/4 WATT POWER OUTPUT

Transformer coupling between transistor amplifier stages provides impedance matching and allows the use of less stages for the same overall gain than r-c interstage coupling. With the new Lafayette KT-69 Kit you can now build a self-powered (4-13 volt penlite cells) push-pull Class "B" transistor audio amplifier having a frequency response from 100-8,000 cps, and the overall power gain is in excess of 50 db. The Argonne Transistor Transformers used in the kit were specially designed for transistor circuits. An important feature of these transformers is their high inductance and low DC resistance. The total harmonic distortion at 400 cycles and 100 mw is 5%. Kit comes complete with 3 Transistors, 2 Argonne Push-Pull input and Output Transformers, Battery Holders, Condensers, Resistors, Aluminum Chassis, 3" x 4 1/2" x 1 1/2" and Schematic Diagram. KT-69 Complete Kit Including batteries Shpg. Wt. 2 lbs. Net **13.95**

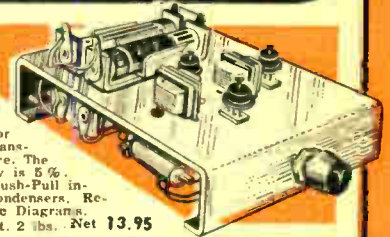

TWO TRANSISTOR PREAMPLIFIER KIT

Humless — Distortionless — Noiseless

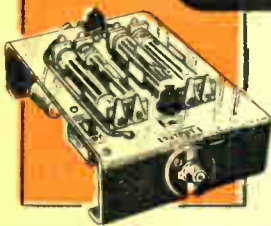

To you, the experimenter, with the Lafayette KT-71 you can now build a simple transistor preamp, in a matter of hours, for a cost considerably less than that of the commercially available single-tube magnetic pickup preamplifiers. The overall result will be a noiseless, humless, and virtually distortionless amplifier. A straightforward circuit is used with grounded emitters and no tricky feedback (see diagram). The output impedance is very low and therefore long leads from the preamp cause no losses. The complete unit is mounted on aluminum chassis size 3 1/2" x 4 1/2" x 1 1/2" power supply and all. There are features to this little job not to be overlooked. The hum is practically zero. The hum pickup and microphonic susceptibility of the preamp are so low that the unit may be mounted directly below the arm on a changer. The kit comes complete with Two Transistors, Battery Holders, Resistors, Condensers, Aluminum Chassis, etc., and Schematic Diagram, and batteries. KT-71 Shpg. Wt. 2 lbs. Net **7.75**

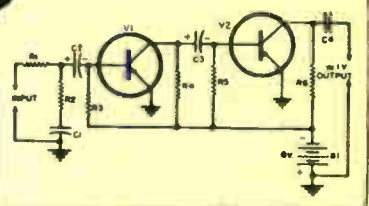

Smallest PM Speaker Made

FOR TRANSISTOR AND SUBMINIATURE CIRCUITS

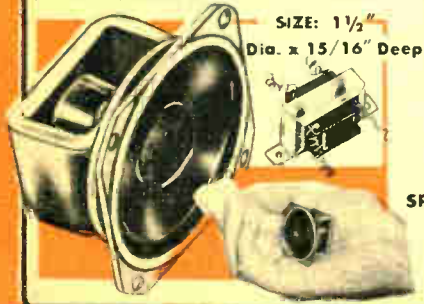

SIZE: 1 1/2" Dia. x 15/16" Deep

At last — the tiny super speaker you've been searching for! Experimenter's, kit builders, and circuit designer's delight for Transistor and subminiature receivers, amplifiers, and circuits. The smallest PM Speaker model Only 1 1/2" diameter by 15/16" deep. Alnico 5 magnet — 10 ohm voice coil — total weight only 1 1/4 oz. Surprising frequency range and output for its size. Mounts at front by four 1/8" mounting holes on 1-9/32" x 1-9/32" mounting centers. A true Lafayette first super value of this unbelievable low priced Shpg. wt., 6 oz.

SK-61 Net **1.95**

SPEAKER WITH OUTPUT TRANSFORMER

With 3/8" x 7/8" x 11/16" 3/4 oz. matching transformer — matches 2000 ohms to 10 ohm voice coil. (Suitable for most transistor outputs). Shpg. wt., 8 oz.

SK-62 Net **2.95**

RCA 2 3/4" PM SPEAKER



REGULAR \$4.90 VALUE

1.69 each in lots of 3



This is the same miniature speaker used in hundreds of thousands of personal portable radios! Leave it to Lafayette—to offer it at an unheard of price! A genuine RCA 2 3/4" PM speaker—1 oz. Alnico 5 magnet—12 ohm voice coil—total weight only 4 oz! Only 1 1/4" overall depth—pre-tapped for mounting. Just what you've been seeking for miniature equipment—receivers—amplifiers—intercoms—transistor circuits—wherever a really small, efficient speaker is needed! Shpg. wt. 8 ozs. SK-39 In lots of 3. each, Net **1.69**

Single, each Net **1.79**

Learn About The Fascinating New Field Of Transistor Circuits

with the **LAFAYETTE 13 IN 1 ADD A UNIT TRANSISTOR EXPERIMENTERS LAB KITS**

LAFAYETTE EXCLUSIVE!

ADD A UNIT KITS

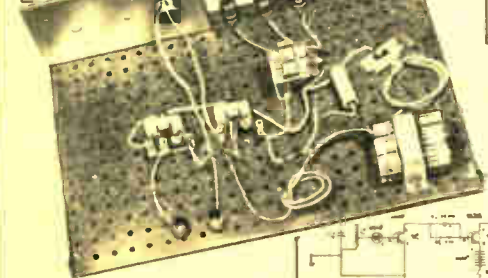
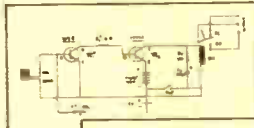
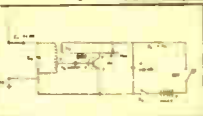
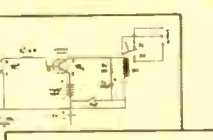
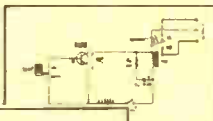
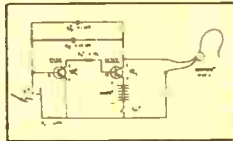
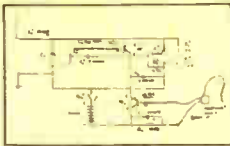
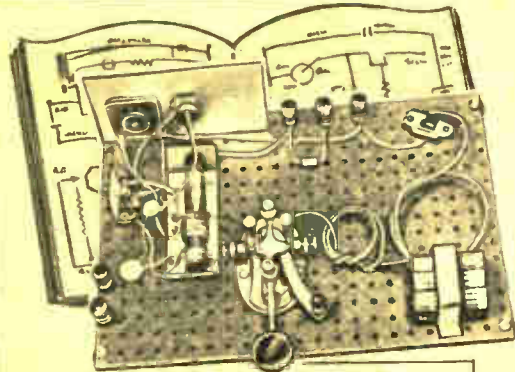

NEW! PRACTICAL! PROGRESSIVE!

Lafayette's transistor lab kits will introduce you to the new miracle of the electronic age — the transistor. You build practical operating units with both NPN and PNP transistors that teach you the fundamentals of transistor circuitry. Additional kits expand the usefulness of the basic kit without duplicating parts so you can economically carry on further experiments. And Lafayette will have more expansion packages for you in the future. Start now!

THE 5-IN-1 BASIC KIT

- BUILD A SIMPLE RECEIVER
- BUILD A REGENERATIVE RECEIVER
- BUILD A CODE TRANSMITTER
- BUILD A LIGHT-POWERED RECEIVER
- BUILD A CODE PRACTICE OSCILLATOR

With the basic 5-in-1 Kit you can build any of these 5 projects. They are simple to assemble from the instructions and each in turn utilizes basic principles and some of the circuitry of the previous project. You build not only such basic units as receivers and code oscillator and transmitters but even a receiver operated by a sun battery! You learn to work with sub-miniature parts such as the exclusive Lafayette variable condenser that is only 3/16" thick by 1 1/2" square. Kit is complete with all parts, schematics, pictorials and instructions. Less headphone, tape and solder. Shpg. wt., 4 lbs.

KT-88 . . . 5-IN-1 BASIC KIT	Net 11.95
CANNON EC-1 . . . HEADPHONE	1.13
MS-273 . . . SENSITIVE MINIATURE EARPHONE	2.39

13-IN-1 EXPANSION KIT

- SENSITIVE PHOTO CELL RELAY
- RAIN ALARM
- LIGHT-POWERED OSCILLATOR
- ELECTRONIC RELAY
- SIMPLE PHOTO CELL RELAY
- HIGH GAIN RECEIVER
- ELECTRONIC METRONOME
- WIRELESS MICROPHONE

An exciting addition to the KT-88 kit to enable you to continue this fascinating and educational program of instruction, including the making of printed (etched) circuitry. The additional parts, diagrams and instructions (along with the parts in the basic 5-in-1 kit) cover the 8 added projects listed above. You'll be able to do such interesting things as broadcasting through your radio without connecting wires, detect moisture or rain, make light actuated relays and much more. And when you've done all these, you can look forward to more Lafayette expansion kits to increase the utility of the kits you already have. Kit is complete with all parts and instructions. Shpg. wt., 3 lbs.

KT-89 . . . EXPANSION KIT	NET 7.50
---------------------------	----------

Combination Deal

Net **18.75**

KT-88 and KT-89 Kit bought together

LORENZ REMOTE CONTROL TRANSMITTER KIT

FOR MODEL PLANES, BOATS AND CARS

14.95

Described in December 1954 Issue **POPULAR ELECTRONICS**

- LAFAYETTE'S entry for superb value in the popular remote control field!

The Lorenz Remote Control Transmitter is a highly efficient instrument designed to operate on the license free "Citizen Band" frequency of 27.255 megacycles. The only F.C.C. regulation is that an F.C.C. form 505 (supplied with kit) be filled out and sent to the nearest F.C.C. office. Designed for use with any "Citizen Band" remote control receiver such as Lafayette KT-84. Transmits signals which are picked up by the receiver for the purpose of remotely controlling model planes, boats, cars and other mechanical units. Its power output provides a wide range of control. Truly tops for value and dependable performance!

KT-87 Less Batteries Net 14.95

1—RCA V5 069 Battery Net .53

2—RCA V50-16 Batteries 2.28 Each Net 4.56



TRANSISTOR REMOTE CONTROL RECEIVER KIT

FOR MODEL PLANES, BOATS AND CARS

- THE MIGHTY MITE OF THE R/C FIELD!
 - WEIGHS 1 OZ.
 - 100% SUB-MINIATURIZED!
- Lafayette takes the lead in the popular R/C field with this super sensitive and efficient subminiature transistorized "Citizen Band" receiver kit. Operates on 27.255 MC and can be used with any "Citizen Band" remote control transmitter. A perfect mate for Lafayette Remote Control Transmitter Kit KT-87. Planned for compactness and sturdiness to withstand severe vibration and shock, yet weighs no more than 1 oz. 2-1/16" L x 1 1/2" W x 1-11/16" D, overall. Uses one 1-1/2 V and one 45V batteries. Battery size depends on size of model.

KT-84 . . . Less Batteries 11.75

REMOTE CONTROL ESCAPEMENT

- At the lowest price anywhere!
- Weighs less than 1/2 oz.!

A fine, sturdy self-neutralizing escapement. Completely wired (not a kit). Converts electrical impulses from remote control receiver to mechanical motion for varying movement of plane, boat, or car. Very low current drain. Size: 1 3/8" L x 1/2" W. Shpg. Wt. 5 oz.

P-194 Net 2.45

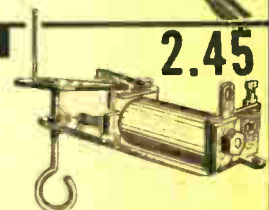
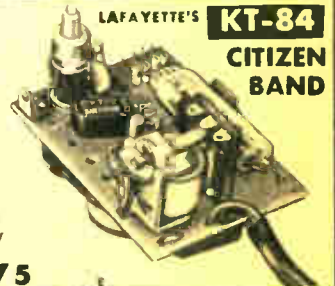

LAFAYETTE

Leads the Field in

TRANSISTORS Circuits Kits & Components



NEW! TRANSISTOR CHECKER KIT

ANOTHER LAFAYETTE FIRST!

7.95

- Checks P-N-P and N-P-N Transistors
- Indicates at a glance — good, bad, high leakage and shorts
- Current gain checked with flip of switch

Lafayette forges ahead in the transistor field with its amazing new P-N-P and N-P-N Transistor Checker. Indispensable to the experimenter, dealer, serviceman and kit builder. Because of the difficulties encountered in transistor manufacture, it is almost impossible to control close tolerances. Lafayette Transistor Checker KT-86 is a must that saves you frustration and time. It checks both P-N-P and N-P-N transistors for leakage and shorts, and indicates at once whether transistor is good or bad. A flip of the switch and the current gain of the transistor is immediately shown on a clear meter dial. An ideal quality check! Pioneer and leader in the field of transistor kits, circuits and parts, Lafayette takes pride in offering this reliable checker to the transistor field at a price which only Lafayette know-how can make possible.

KT-86 — Transistor Checker Kit

\$7.95



5 TRANSISTOR AUDIO AMPLIFIER KIT

17.50

- Class B Push-Pull Output for speaker operation
- Preamp stage for magnetic cartridges
- Input for magnetic cartridge or crystal mike
- Input for crystal cartridge or tuner

Here is the first practical completely transistorized audio amplifier kit using 5 transistors and 2 special Argonne push-pull input and output transformers. Two inputs are provided, one for magnetic cartridges and crystal mikes, one for crystal cartridge and radio tuners. Operates on only 4-1 1/2 V penlight cells. The preamp stage is designed for such phono cartridges as the GE variable reluctance and other hi-fidelity magnetic cartridges, and provides extra amplification and equalization required. The preamp stage features extremely low distortion, noise and hum. The Argonne transformers are the highest quality. Specially designed for transistor circuits. A volume control is provided. Kit is complete with 5 transistors, two Argonne transformers, condensers, resistors, batteries, battery holders, chassis and all new necessary parts with schematic and pictorial diagrams and instructions for assembly and operation. Chassis size 3 1/2" L x 4" W x 1". Shpg. wt., 2 lb.

KT-82 — Including batteries

Net **17.50**

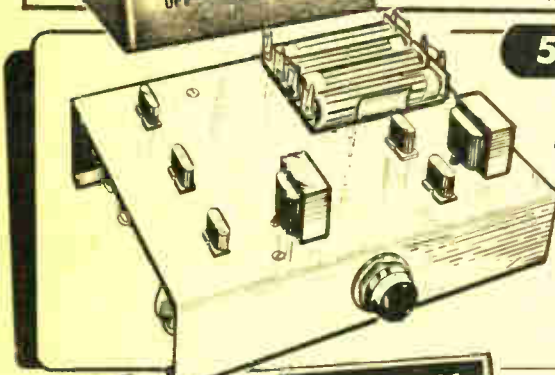

CADMIUM SULPHIDE PHOTOCELL RELAY KIT

11.50

Cadmium sulphide is another semi-conductor used as the active material in modern photocells. This kit utilizing the miniature cloirex cadmium sulphide photocell has a high sensitivity, serves as the heart of burglar alarm systems; lighting control systems; door openers; motor or similar devices. The relay circuit is operated directly from the 110 volt A.C. line. Incorporates a 5823 cold-cathode tube resulting in quick rated operation of very low illumination levels. Relay contacts rated at 5 amps. Kit comes complete with chassis, size 3" x 4" x 5", resistors, condensers, metal case and shpg. wt., 4 lbs. Schematic diagram and instructions. Shpg. wt., 4 lbs.

Net **11.50**

KT-81 — Complete Kit

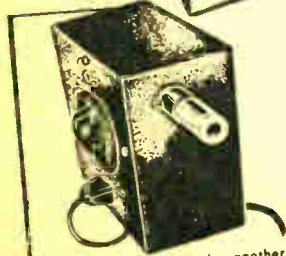

TRANSISTOR POCKET RADIO RECEIVER KIT

Utilizing One Transistor and Crystal Diode Detector with New Miniature 365 mmf Variable Condenser

4.95

Here is an ideal low cost transistor pocket radio kit for students, hobbyists and the experimenter, who desire to obtain a practical knowledge of transistorized circuits. The circuit utilizes a Ferris Loopstick and a specially designed miniaturized 365 Variable Condenser permitting the entire receiver to be built in a plastic case size 3" x 2" x 1". The 1N64 Crystal Diode is used as a detector, the transistor is connected as a grounded emitter amplifier. This receiver with a 50 foot antenna and good ground will bring in good reception over a 50 mile radius. The kit comes complete with transistor, crystal diode, battery holders, batteries, condensers, resistors, plastic case, etc., plus a 115 page book, showing more than 50 practical transistor circuits and How-To-Do-It-Instructions. Shpg. wt., 1 lb.

KT-80 Complete Kit (less earphones)

4.95

1 Miniature Crystal Ear Receiver MS-111

T.49

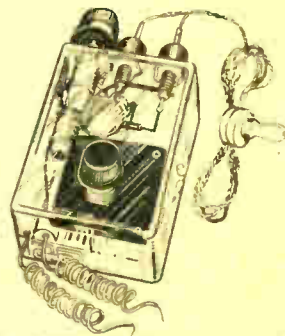

TRANSISTOR TELEPHONE PICK-UP AMPLIFIER KIT

TWO CAN LISTEN ON SAME PHONE CONVERSATION

With this ingenious Kit you can build a tiny transistorized telephone pick-up amplifier, with which two people can listen in on telephone conversations without the need of an extension phone. Also serves as a high gain amplifier to feed into a tape recorder, for recording telephone conversations. Can also be used as a portable amplifier with crystal microphone and matching transformer when desired. The circuit utilizes a transformer coupled audio for high gain and two R-C, coupled stages. Kit comes complete with 3 transistors, Transistor Audio Transformer, Condensers, Resistors, etc., and Plastic Case. Size: 2 1/2" x 1 1/2" x 3 1/2". Including batteries. Shpg. wt., 2 lbs.

KT-76 Complete Kit (Less Telephone Pick-Up and Earphones)

Net **9.45**

MS-16 Telephone Pick-Up

Net **2.95**

MS-111—Crystal earphone for above

T.49

MS-260—Super power high output dynamic earphone for optimum results

Net **3.95**

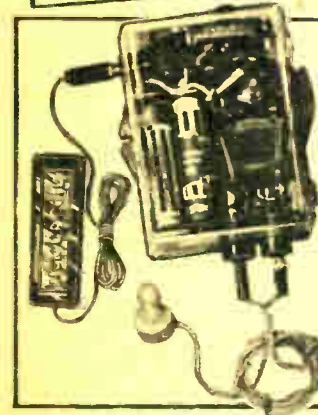

STAY AHEAD IN TRANSISTORS These Books Show You How

ELECTRONS AND HOLES IN SEMICONDUCTORS

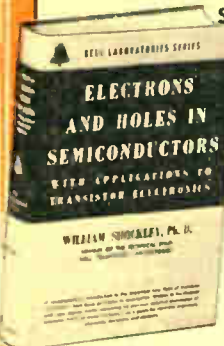

by William Shockley, PH.D.

Here, clearly and accurately presented, are theoretical and practical texts from one of the world's greatest industrial laboratories. This book has been prepared to provide a practical theoretical and working knowledge of the properties and uses of transistor devices for electrical engineers, physicists, designers, and students, whether or not they possess the mathematical knowledge formerly essential to an understanding of quantum theory or wave mechanics. The organization and content are based upon a series of lectures given at the Bell Telephone Laboratories. The developmental approach is particularly well adapted to furthering an understanding of the method by which the behavior of holes and electrons can now be inferred directly from the new post-transistor experiments, with a sufficient degree of definiteness for most purposes of transistor electronics. Charts, graphs and illustrations throughout.

551 pages
9.75

FUNDAMENTALS OF TRANSISTORS



by Leonard Krugman

Learn all about the transistor! It's the thing in electronics today! With more and more uses for the transistor being developed all the time, every service technician, student, engineer, and experimenter should be familiar with the transistor—should know their characteristics and operation! Leonard Krugman, who wrote this authoritative book, is one of the pioneers in transistor development and application. His presentation covers every phase—everything you need to know about this electronic miracle! No complicated mathematics—it is clearly written so everyone can understand! Provides workable information on the transistor without the burden of theory and mathematical concepts. Careful study of this book will provide a basic foundation upon which to build further study and experimental work.

Rider #160—134 pages with illustrations 2.70

28 USES FOR JUNCTION SYLVANIA ELECTRIC TRANSISTORS



Here is a new booklet of practical applications for transistors of interest to servicemen, experimenters, students, hobbyists and industrialists. This booklet lists twenty-eight popular uses for transistors. Prepared from laboratory data accumulated from tests of many devices. While the booklet is addressed primarily to experimenters and electronic hobbyists, we believe that engineers and technicians will find material of interest on its pages. Theory has been held to a minimum. A list of theoretical references appears at the end of the first chapter. The booklet is profusely illustrated aside from the numerous tables and charts throughout.

41 Pages, Illustrated, 6" x 9" 25c

TRANSISTORS

by Coblenz & Owens

This Book treats theory, Practical applications and manufacture of Transistors in a very useful way. It contains a short history of Transistors, how they work, how they are made, and how they are used—Step-by-step from basic concept to advanced topics. Discusses both Silicon and Germanium transistors, and the latest circuits such as switching circuits, Cascading circuits, etc.

313 Pages, Illustrated, 6" x 9" 6.00

TRANSISTORS—THEORY & PRACTICE

by Rufus P. Turner

TRANSISTORS FROM THE VIEWPOINT OF THE PRACTICAL MAN

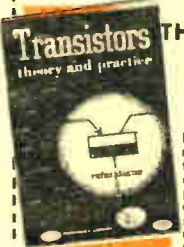

Information packed, this easy-to-read book explains semiconductor theory, transistor characteristics, equivalent circuits, transistor amplifiers, transistor oscillators, quality in transistor circuit design, triggers, switches, tests and measurements. Lists characteristics of commercial transistors. Has numerous circuits for the builder or experimenter and data on practical transistor circuits. Contains recommended reading list at end of each chapter. Also lists characteristics of commercial transistors. Attractively bound in soft cover. Profusely illustrated.

Gernsback #57—144 pages—5 1/2" x 8 1/2" 2.00

TRANSISTORS

by Louis E. Garner, Jr.



"Transistors and Their Applications in Television-Radio Electronics," by Louis E. Garner, Jr., is the first practical book about transistors for servicemen, engineers, amateurs and experimenters. Explains in easy-to-understand language the theory and practical applications of transistors. Clarifies transistor circuitry, installation, testing techniques theory and servicing. Also covers development; physical and electrical properties; transistor amplifier circuits, oscillator circuits, special circuits and many other interesting subjects.

CTB-7—100 pages, illustrated 5 1/2" x 8 1/2" 1.50

TRANSISTOR AUDIO AMPLIFIERS

by Richard F. Shea

Outlines basic fundamentals of transistor application in the Audio Amplifier field. Shows how these principles can be applied in designs, and how to achieve the ultimate performance from these units. The treatment is general and can be applied to a great majority of specifications available from transistor manufacturers. A large amount of practical material is included, such as information on the design of pre-amplifiers and power amplifiers. Also provides necessary tools for designs of audio amplifiers to meet the demand of frequency response, signal to noise ratio etc. Contains various charts and tables.

219 Pages ... Illustrated 6" x 9 1/4" 6.50

PRINCIPLES OF TRANSISTOR CIRCUITS

by Richard F. Shea

Mr. Shea, along with numerous co-authors has gathered a large portion of existing material on transistor circuits. The treatment is general, built around generalized, equivalent circuits that can be used to suitably represent a great majority of transistors. Each section presents and analyzes equivalent circuits, the mathematical relationships, and develops applicable circuits. Current network theory is used and modified to fit transistor applications. The book treats and analyzes both P-N-P and N-P-N units.

535 Pages ... Illustrated 6" x 9 1/4" 12.75

TRANSISTOR ELECTRONICS

by Le. Endres, Zewel, Waldhauer & Cheng — of RCA LABORATORIES

Here is a fully integrated approach to both the theory and practice of transistors and transistor circuits by five authorities in the field of electronics. Presented here for the first time are some of the results of their original research. The reader is taken from a basic working understanding of transistor operation and circuit analyses to practical circuit design technique. It discusses transistor operation at high frequencies — practical design procedure — and a full explanation of oscillators, modulators, detectors, and computer-type switching circuits. Over 365 illustrations, charts and tables.

508 Pages ... Illustrated 6" x 8 1/2" 11.00

TRANSISTOR HANDBOOK

by W. D. Bevin

The first handbook survey of the entire field of transistor circuits and applications. A thorough presentation of the practical aspects of transistors — what the transistor is doing toward making electronic circuits simpler, more efficient, more compact and in making possible new circuits. Covers fundamental physical concepts, characteristics, measurements, behavior, and circuit properties of transistors. Contains the most comprehensive subject index of its kind — 380 illustrations and a chart listing commercially available transistors and their characteristics.

428 Pages ... Illustrated ... 5 1/2" x 8 3/8" 9.00

G.E. TRANSISTOR TESTER



New

• A LOW COST TRANSISTOR TESTER PLUS

• 5 POPULAR RADIO-REPLACEMENT TRANSISTORS

39 50

An attractive completely assembled transistor tester that checks all PNP and NPN transistors for Good-Bad-Leakage and Gain. Has easy-to-read colored scale that indicates GOOD-FAIR-POOR on LEAKAGE test, and a separate graduated scale for GAIN test. Meter can be zero adjusted for additional accuracy. Includes 5 popular quality radio-replacement transistors consisting of high frequency RF-IF types 2N137, 2N136 and 2N135, and of audio types 2N73 and 2N44. Complete with easy-to-follow instructions and Transistor Interchangeability Information for the popular transistor radio sets.

GE Transistor Tester — complete

Net 39.50



DO IT YOURSELF - Build Your Own Kits!



7-IN-1 MULTI-CIRCUIT RADIO LAB KIT WITH HEADPHONE

- ONE TUBE BROADCAST RECEIVER
- CODE NUMBER - LIGHT
- WIRELESS HOME BROADCASTER
- SIGNAL TRACER
- CODE PRACTICE KEY
- SINE WAVE GENERATOR
- WIRELESS CODE PRACTICE OSCILLATOR

9.98

With this smaller version of the 10-IN-1 kit, you can build any one of the 7 circuits. 16 Page instruction book shows pictorially how to wire quickly and easily and explains the basic operation of these circuits including many fundamentals of radio servicing. Perfect for electronics minded youngsters. Kit is complete with earphone, 6SN7 tube, board, power transformer, selenium rectifier, resistors, condensers and all necessary parts. Less wire. Shpg. wt. 4 lbs. Net 9.98

KT-42

GERMANIUM DIODE RADIO SET KIT



3.29

Real basic kit using the new germanium diode. Builds a highly sensitive radio set. Requires no batteries or power supply. Kit includes pre-wound coil, single gang condenser, germanium diode, board, template, headphone, knob, hardware and instruction book. Less wire. Shpg. wt. 2 lbs. Net 3.29

KT-43



2-IN-1 KIT

- PERSONAL 1 TUBE RADIO
- WIRELESS HOME BROADCASTER

5.98

Requires no soldering. All wires and parts fit into clips. You can build a vacuum tube operated radio with volume control and an on-off switch. Covers the broadcast band; or you can build a wireless home broadcaster with which you can broadcast your own voice thru any radio in the house within 20 ft.; or you can connect it to a phonograph and play records through your radio without any connecting wires. Kit is complete with tube, variable condenser, pre-tuned tuning coil, volume control, switch, board, template, instruction and earphone (which doubles as a microphone). Less batteries. Shpg. wt. 3 lbs. Net 5.98

KT-44

BATTERIES

[Kit uses one each.]
RCA = V5036 - 1 1/2 volts Net .10
RCA = V5055 - 15 volts Net 1.42

PHILMORE CRYSTAL RADIO KIT

Excellent for beginners. Provides basic radio theory. Not a toy. Kit includes a fully wound easy-to-use slide-coil, crystal detector, and cats whiskers. No soldering necessary—the only tool needed is a screwdriver. Shpg. wt. 1 lb. PHILMORE 7000K 1.29

AM-15-1 - Single headphone for above 1.18



1.29

EREC-TRONIC SET

- BUILD AND REBUILD 15 DIFFERENT CIRCUITS!
- APPROVED BY THE BOSTON MUSEUM OF SCIENCE!
- USED IN OVER 400 HIGH SCHOOLS AND 50 ENGINEERING COLLEGES!
- NO TOOLS REQUIRED - WIRE BY MEANS OF THE AMAZING "JIFFY CLIP"!

In 10 minutes you can have a completed, working radio! Immediate results promotes enthusiasm. Separate do-it-yourself pattern for each of the circuits. Builds 12 receivers - including one for short wave reception - wireless transmitter - code oscillator. Built in testing device develops troubleshooting abilities. "Electronic safety valve" protects all parts from damage. All parts plug into perforated chassis base - all wiring is done with solderless "Jiffy Clips". Completely new approach to fun with electronics. Completely shock-free! Includes 36 page operations manual - shows how to assemble and operate circuits - answers questions. Complete with all parts - including tube - diode - headset - key - etc. Net 19.95

KT-93
SPECIAL - LAFAYETTE SUPPLIES THIS KIT PREPAID COMPLETE WITH 1 1/2 VOLT "A" BATTERY AND 45 VOLT "B" BATTERY!



19.95 Prepaid
COMPLETE WITH BATTERIES!

4.70

HEARING AID FOR RADIO

New headphone type hearing device increases radio enjoyment for persons who find it difficult to hear radio programs properly. Also for private listening without disturbing others. Quickly and easily attaches to any radio in a matter of minutes. Supplied with switch permitting speaker only, phones only or both. Low-resistance phone match. Headset (cell) 4.70

DC-1 - Same bus with single phone 3.37
K-4 - 3-way switch adapter only 1.80



AM-15-2

"EMPIRE" DOUBLE HEADSET

Low priced, light weight set with large magnets and double coils. Adjustable steel headband. 1 1/2 ft. cord. EA. 2.08

AM-15-2 2000 ohms EA. 2.08
EC-3. 3000 ohms EA. 2.29

"EMPIRE" SINGLE HEADSET

Efficient, attractive single phones. Spring steel headband. EA. 1.18

AM-15-2 1000 ohms EA. 1.17
EC-1500. 1500 ohms

BRANDES "ADMIRAL" HEADPHONES

A rugged, "matched tone" headset. Extra large diaphragms. Double coils, chrome steel magnets. Adjustable steel headband. 4 1/2 ft. cord. EA. 2.44

BA-2. 2000 ohms EA. 2.44
BA-3. 3000 ohms EA. 2.73
BA-5. 5000 ohms EA. 3.53

BRANDES "SUPERIOR" HEADPHONES

A "matched-tone" headset of same general construction as the "Admiral" but has terminals on the outside. EA. 2.44

BS-2. 2000 ohms

AC-DC BROADCAST RADIO SET KIT

- COMPLETE WITH TUBES AND CABINET
- 16 PAGE INSTRUCTION BOOK plus 3D COLOR EYE-O-GRAMS

Not just ordinary schematic and pictorial diagrams, but a new simple method that makes building a circuit 3 different ways transparent sheets show the wiring for each circuit; each of these is over a master chassis photograph. A master copy shows all 3 steps in individual colors - and when you're through you'll have a fine superhet set covering 550 to 1400 KC. in modern brown plastic cabinet with built in antenna. Size 9x12x11. Complete kit with 2 tubes, cabinet, speaker, and all parts. Shpg. wt. 2 lbs. Net 14.95

KT-19



14.95

ECONOMY ANTENNA KIT



89c

Ideal for use with small crystal and diode sets, for both broadcast and shortwave. Kit contains 50 ft. of standard copper aerial wire, 25 ft. lead-in wire, lead-in strip, ground clamp, 2 antenna insulators, 2 nail-nob insulators and instructions. Shpg. wt. 2 lbs. KT-77 89c



PHONE AND SPEAKER CORDS

4 1/2 Feet Long

Sturdily made, with cotton braid insulation. 4 1/2 feet long. MS-35 - Double type. 1 and single type, other straight 39c
MS-36 - Double type. Pin tips both ends 39c
MS-37 - Single type. Pin tips both ends 27c

MALLORY MIDGET JACKS

Extremely compact. Mount in 5/16 hole. 1 1/2" A-1 "Infant" jack is not illustrated.



Mallory	Type	Each
A-1	Open circuit	.15
A-2	Ctr. closing, shorting	.29
A-2A	Two circuit	.42
A-3A	Ctr. reverse	.47

POPULAR PHONE PLUGS



For 1 or 2 phone or speaker cords. Molded bakelite shell 2 3/4" L x 3 3/4" dia. Screw terminals. MS-38 - Black Each 27c

STANDARD PHONE TIPS

Heavily plated. Takes up to No. 18 wire. 1 1/2" long. MS-39 - 10 for 12c
100 for 1.00

MINIATURE PLUG AND JACK

Two-conductor precision army type. Needs no screws, molded plastic case centers together. Ideal for hearing aids, speaker systems, etc. MS-40 - Plug only (type PL-29) Each 35c
MS-41 - Jack only (type JK-15) Each 47c



Build Your Own Kits ENJOY THE FINEST AND SAVE!

TO WATT PUSH PULL HI-FI AMPLIFIER KIT



- BUILT-IN PREAMPLIFIER FOR GE RELUCTANCE CARTRIDGE
- SELECTOR SWITCHES PERMIT CHOICE OF THREE INPUTS
- SEPARATE BASS AND TREBLE CONTROLS
- 4, 8 AND 16 OHM OUTPUTS
- EASY-TO-FOLLOW INSTRUCTIONS

21.50

This new, economy hi-fi amplifier has many deluxe features for exceptional performance. The three inputs are radio, crystal phono pickup, magnetic phono pickup and microphone. A selector switch changes the input from radio/crystal to microphone or magnetic pickup, depending upon the position of a rear apron slide switch.

OUTPUT — Rated 10 watts, peak 18. **FREQUENCY RESPONSE** — ± 1 db 30-15,000 cps. **DISTORTION** — 1.5% harmonic, 4% intermodulation at 8 watts. **4 CONTROLS** — Input Selector; Volume; Treble; Power-On-Off-Boss. **TREBLE CONTROL** — Flat response up to 15 db boost. **BASS CONTROL** — Flat response up to 18 db attenuation. **OUTPUT IMPEDANCES** — 4, 8 and 16 ohms. **TUBES** — 65C7, 65L7GT, 2 — 6V6GT and 5Y3GT rectifier. **AUXILIARY AC OUTLET** — Distinctive Hammer-tone finish. **SIZE** — $10\frac{1}{2}$ " x $6\frac{1}{4}$ " x $5\frac{1}{4}$ ". **WEIGHT** — $8\frac{1}{2}$ lbs. For 110-120 Volts. Complete kit with coded wire, highest grade solder and detailed instruction manual. Net **21.50** KT-91

PUSH-PULL—6 WATT HI-FI AMPLIFIER KIT



- LOW COST, REALISTIC HI-FI KIT
- CATHODE-RAY OUTPUT INDICATOR
- HUM LEVEL—78 DB BELOW FULL OUTPUT
- 4, 8 and 16 OHM OUTPUT IMPEDANCES
- PHASE INVERTER PUSH-PULL OUTPUT
- 24 PAGE ILLUSTRATED INSTRUCTION BOOK

15.45

A high-quality down-to-earth priced hi-fi audio amplifier kit with frequency response 40-12,000 cps ± 1.5 db. Self-contained AC power supply, 117 volts, 50-60 cycles with separate AC on-off power switch. The volume control is continuously variable, requires but .5V input. The tube complement consists of 12J5—1st amplifier, 12SL7—phase inverter, 2-12A6—push-pull beam power output, 5Y3GT rectifier and 1629 cathode-ray output indicator. Micro filer sockets. The chrome plated chassis is a compact size 11" long, $6\frac{1}{2}$ " wide and $5\frac{1}{2}$ " high and is adaptable to book shelf mounting. Supplied with escutcheon template and matching silver-inlay knobs. Complete with instruction book containing step-by-step pictorial and schematic diagrams. Shpg. wt., 13 lbs. A-870

Net 15.45

5-WATT PUSH-PULL AC-DC HI-FI AMPLIFIER KIT

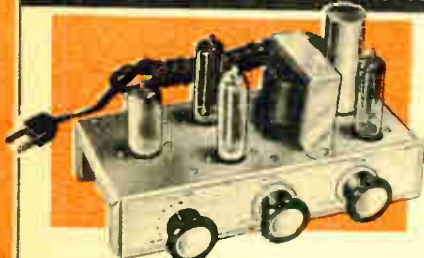

- SEPARATE VOLUME, BASS AND TREBLE CONTROLS
- PUSH-PULL AUDIO OUTPUT STAGE
- INVERSE FEEDBACK CIRCUIT
- AC OR DC OPERATION

10.95

Here in kit form is an AC-DC hi-fi amplifier that presents unusual features despite its amazingly low price. The separate bass and treble controls permit adjustment of both low and high frequency response and balance. Works equally well with both crystal or ceramic cartridges. Has a 4-tube line up—12AX7 amplifier and phase inverter, a 35W4 rectifier and a pair of 35C5's in push-pull, having a power-packed low distortion output. The circuit utilizes an inverse feedback loop to reduce the level of hum and distortion. Kit is complete containing all essential parts, tubes and detailed instruction manual showing pictorial and schematic diagrams. Shpg. wt., 4 lbs. KT-92

Net 10.95

PREAMPLIFIER KIT WITH BUILT-IN SIX POSITION EQUALIZER FOR G.E. AND PICKERING CARTRIDGES



- 3 POSITION INPUT SELECTOR SWITCH
- OVERALL GAIN CONTROL
- SEPARATE BASS AND TREBLE CONTROLS
- FLOATING TUBES TO PREVENT MICRO-PHONISM

15.95

This preamplifier designed for use with Williamson-type and other high quality audio amplifier systems. There are 3 input connectors, radio, crystal and magnetic, with corresponding 3 input selector switch. The separate bass and treble controls approximate 15 DB. The 6 position equalizer assures proper playback of all types of recordings. The two 7F7 tubes are free-floating to prevent tube microphonism. Separate on-off switch and pilot light. Power required by this unit is 6.3V — 6A AC or DC and 150V DC at 7 milliamperes. This power may be obtained from the A890 or any similar amplifier. Power line cord, power switch, pilot light and rear mounted power outlet for main amplifier provided. Supplied with 36" power supply cable for easy connection to main amplifier. The unit is 12" x 4" x 2" and comes in a rich gold finish. Complete with tubes and all parts and 24-page instruction manual containing pictorial and schematic diagrams for step-by-step assembly and wiring. Shpg. wt., 6 lbs. A-800

Net 15.95

TECHMASTER HI-FI FM TUNER KIT



29.50

A superior quality basic hi-fi FM tuner kit designed for optimum performance and fidelity at a minimum cost. Features advanced drift-free circuitry having excellent selectivity and clean, faithful audio reproduction. Self-contained power supply. Micro-vernier tuning covers 87-109 MC range. Full 200KC IF bandwidth. Has a grounded grid RF stage. The AFC has a manual front-control cutoff to pick up weak signal stations adjacent to strong signal stations. Contains a no-drift ratio detector and standard de-emphasis network. Cathode follower output permits long cable to amplifier without loss of highs. **SENSITIVITY**: 4 UV for 20 DB quieting. **OUTPUTS**: Cathode follower, .8V RMS; high impedance 3.2V RMS. **TUBE COMPLEMENT**: 2-12A17, 6BA6, 6AU6, 6AL5, 6C4 plus selenium rectifier. **SIZE**: $4\frac{1}{2}$ " x 8" x $6\frac{1}{4}$ ". **INPUT IMPEDANCE**: 300 ohms. Complete with punched chassis, all tubes and hardware (less wire and solder) with detailed easy-to-follow instructions. Shpg. wt., $6\frac{1}{2}$ lbs. Net **29.50** TECHMASTER FM-18

Net 7.50

TECHMASTER FM-18

CM-18 Cabinet for Tuner

TECHMASTER DELUXE SELF-POWERED PREAMP-EQUALIZER KIT

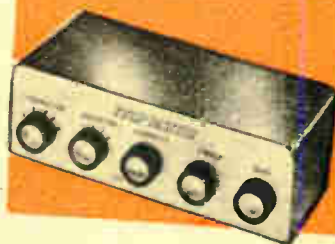

24.50

Anyone can build this fine self-powered preamp-equalizer, and have a really professional instrument that will provide new beauty and versatility to your music reproducing system. Has 4 input channels, one low level high gain and 3 high impedance. Separate bass and treble controls give 15 db boost or attenuation of 20 cycles and 20 KC respectively. Perfect matching of recording curves assured by 5 position equalization control for 78 RPM, Old 78's R1AA, FRFR and AES, 60 cycles — isolated transformer. Cathode follower output. Loudness compensating Simple diagrams. Kit is complete with all tubes, cabinet and connectors riveted on chassis. Size $9\frac{1}{2}$ " x $3\frac{1}{2}$ " x $4\frac{1}{2}$ ". Shpg. wt. 5 lbs. TECHMASTER TM-16SP

Net 24.50

New! LAFAYETTE 10-IN-ONE LABORATORY KIT

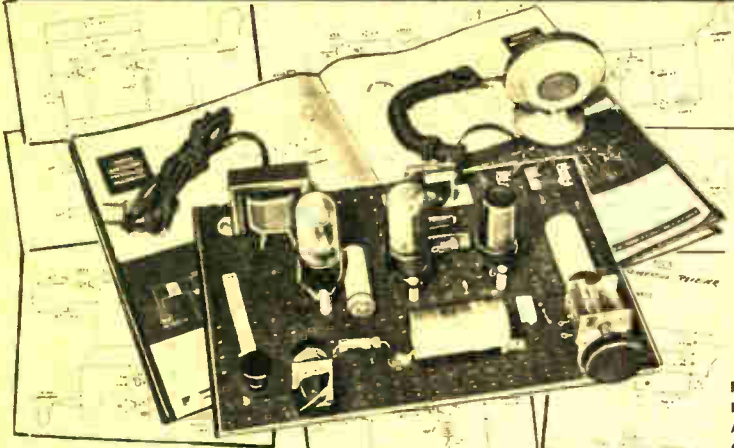

BUILD ANY OF THESE INTERESTING EDUCATIONAL, AND ENTERTAINING PROJECTS WITH THESE EXPERIMENTERS MULTI-PURPOSE RADIO KIT.

1. RADIO RECEIVER
2. PHONO-MICROPHONE AMPLIFIER
3. PHONO OSCILLATOR
4. BROADCAST STATION
5. CODE PRACTICE OSCILLATOR
6. CAPACITY OPERATED RELAY
7. SIGNAL TRACER
8. ELECTRONIC TIMER
9. ELECTRONIC SWITCH
10. PHOTOCELL RELAY

Here is a new laboratory tested experimenters kit designed to provide maximum instruction and entertainment and which is ideal for both the beginner and advanced experimenter. Features practical and interesting circuits which enable you to do many novel and interesting things while learning how these circuits function. You can broadcast your voice or play a phonograph through your radio from anywhere in the house, send code through a headphone or radio, or use light or body capacitance to activate electrical circuits. Safe, low voltage is utilized. Kit is complete with perforated mounting board, 3 vacuum tubes, microphone and all parts necessary for construction. A detailed 12 page instruction manual contains simple-to-follow pictorial and schematic diagrams for each project. Less headphone, photoelectric cell and socket, wire and solder. Shpg. wt., 5 lbs.

KT-36A	Net	11.95
PHOTOELECTRIC CELL TYPE 868		2.00
AMPHENOL 77MP4 SOCKET FOR ABOVE		.08
CANNON ECT 1000 OHM SINGLE HEADPHONE		1.13

LAFAYETTE GEIGER COUNTER KIT

- BUILD YOUR OWN LOW COST URANIUM DETECTOR
- USES SAME HIGHLY SENSITIVE COUNTER TUBE FOUND IN \$100 DETECTORS

Lafayette has engineered this high quality radiation detector with your pocketbook in mind. Some measure of the value you receive at this low price is the Victoreen 1B85 — some tube used in detectors selling for \$100. As simple to operate as it is to construct. Radiation is detected as clicks in the headphone, the heavier and closer the radiation, the more rapidly the clicks increase. Uses long life, low cost batteries. Kit is complete with all parts, bakelite cabinet, Victoreen 1B85 tube, radio-active sample, batteries, headphone and simple instructions and diagrams for construction and operation. Size 6 3/4" x 5 1/4" x 2-5/16". Shpg. wt., 2 1/2 lbs.

KT-75 KIT	NET	14.95
Extra set of batteries for above	NET	1.07



**WITH HIGH SENSITIVITY
VICTOREEN TUBE 1B85**



REMOTE CONTROL FOR SILENT TV VIEWING

- SIMPLE TO ATTACH TO ANY TV SET OR RADIO
- SEE AND HEAR—NOISELESSLY—CONVENIENTLY
- LOOK AT THESE FEATURES!

1. **FOR LATE LISTENERS:** One or two people can both see and hear the program with the loudspeaker cut off. Tops for enjoying the late-late show without disturbing the rest of the household or the neighbors.
2. **FOR HARD-OF-HEARING:** They can see and hear without turning the set volume so high that others can't stand the noise. They can listen either with the loudspeaker cut off or, if the rest of the family want to hear, with the speaker on.
3. **FOR NOISY PROGRAMS:** Don't let the kids' "Wild Westerns" bother you. Let them view and listen with the speaker cut off.
4. **FOR NORMAL OPERATION:** Does not affect your regular use of the T.V. set. Does not have to be disconnected from set.
5. **REMOTE CONTROL:** Comes complete with 20 ft. of cable so it can be operated comfortably from a distance. Has its own volume control, speaker on-off switch, and two sets of jacks to either 1 or 2 ear phones can be connected.
6. **DYNAMIC EAR PHONE:** Set is supplied with one of ARGONNE exclusive Hi-Fi dynamic miniature earphone. Highly sensitive and efficient. Phone is complete with 3 ft. cord and tips, ready to insert in control box.
7. **CONVENIENT:** Size only 3 3/4" x 2" x 1 1/4". Complete with 1 earphone and 20 ft. cable. Completely wired with instructions. Shpg. wt. 3 lbs.

MODEL MS-125 NET 6.50

EXTRA EARPHONE

To plug in to extra jacks on control box so two can listen.
MS-124 NET 1.95

12" GE HI-FI PM SPEAKER

- HANDLES 25 WATTS
- 14.5 OZ. ALNICO V MAGNET
- 50-13,000 CPS FREQUENCY RESPONSE
- ALUMINUM VOICE COIL

14.95

This GE deluxe speaker was designed by audio engineers to meet the high standards of performance so essential to high-fidelity and for dependability and durability. The 14.5 oz. Alnico V magnet produces a dense magnetic field with resultant optimum sensitivity and damping factor. The aluminum base voice coil is unaffected by moisture and temperature variations and eliminates buzzing. Exceptionally wide frequency range — 50 to 13,000 cycles which may be extended to 30 cycles in properly designed enclosures. Free air resonance 65 cps. The voice coil has a 1 1/2" diameter and 8 ohms impedance. This speaker, which scientific listening tests indicate can outperform speakers costing several times as much, is ideal for moderate-cost hi-fi custom installations. Shpg. wt., 7 lbs.

SK-60 Net 14.95



SMALL HAYDON ALL-PURPOSE MOTOR

.95

This small 2.2 watt 450 RPM motor is an excellent buy at this low price. Experimenters and hobbyists can find many applications for this versatile motor which is particularly suited to displays requiring animation. This fully-enclosed unit features a built-in synchronization indicator and can be operated in any position on 110V 60 cycle AC. Encased in 2" diameter x 7/8" housing. Mounting plate has holes 2 3/8" apart.

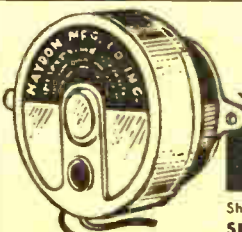

Shpg. wt., 1 lb.
SP-138 Net 95¢

precise Easy-to-Build TEST EQUIPMENT KITS

PRECISE MODEL 116K Gm and Em. ULTRAFAST TUBE AND TRANSISTOR TESTER KIT



- CHECKS TRANSDUCTANCE AND EMISSION FOR FOOLPROOF TESTING!
- FASTEST, MOST ACCURATE FOR ON-THE-JOB QUICK TEST—CHECKS 5 TUBES IN 20 SECONDS!

Precisely engineered for outstanding tube tester value and performance. A serviceman's dream, Model 116 makes tube testing foolproof by checking mutual transconductance as well as cathode emission with incomparable speed and accuracy for on-the-job testing. Plug in 5 1F tubes and let them heat up at once and then check each one separately by rotating the TUBE BANK switch. Actually check 5 tubes in 20 seconds, 4 seconds per tube! Checks 1F amplifier tubes for GM (mutual transconductance) and power amplifier tubes for Em (emission), as well as generally. Each section of duotriode, duo-diode-triode, etc. is separately tested by rotating FUNCTION SWITCH. Has only 3 basic knobs. Checks TRANSISTORS, SHORTS, GAS, LIFE, Em, Gm, etc.

Complete with attractive, etched panel, Moleskin covered wood carrying case and cover, and specially simplified instructions that make assembling and wiring a snap. 14" x 16" x 6". Shpg. wt., 23 lbs.

MODEL 116K — KIT, complete NET 69.95
MODEL 116W — Factory wired NET 119.95

PRECISE MODEL 300 BK 7" SCOPE KIT

- FOR COLOR AND BLACK AND WHITE
- SUPER-VALUE — LABORATORY PRECISION!



An expertly engineered 7" scope kit. Vertical-flat ± 3 db through 5 megacycles with sensitivity of 10 millivolts. Bridge type positioning on vertical and horizontal does not vary tube characteristics. Frequency compensated vertical and horizontal stepping attenuators. Push-pull DC amplifiers; push-pull horizontal out. Five way binding posts for easy hookup. Internal and external Blanking through Blanking amplifier circuit. Linear sweep from 1 cycle to 80 kc. Electronic magnifier circuit allows any part of a signal to be magnified up to ten times (equal to 70 inches of horizontal deflection). Internal square wave calibrator and potentiometer for using scope as a VTVM on Peak to Peak measurements. Edge-illuminated filtered calibration screen — can be turned on or off. Astigmatic focus and intensity control. Has 5 outputs on front panel — Plus Gate, Sawtooth, 60 cycle phasing, 60 cycle unphased, Calibration. High quality, low loss components throughout. Deeply etched aluminum panel; steel cabinet 11" x 14" x 17". Complete with all parts and instruction book. For 110-120 volts, 60 cycle AC. Shpg. wt., 35 lb.

MODEL 300BK — KIT, complete Net 99.95
MODEL 300BW — Factory wired Net 199.50

PRECISE 8 1/2" OSCILLOSCOPE KIT MODEL 308K

- THE PROFESSIONAL'S WIDE-BAND SCOPE
- EASY TO OBSERVE EVEN THE SHARPEST PULSE!

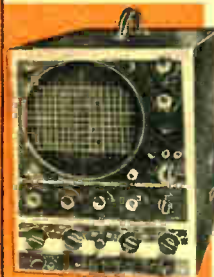

A super scope kit for the laboratory and shop designer with the latest cathode ray tube available in the commercial field. Magnifier positioner permits extremely accurate waveform analysis. Vertical section has features found only in the most expensive and custom made scopes; Push-Pull inputs for internally mixing two signals or observing push-pull waveforms; Frequency-compensated Stepping Attenuator, Bandwidth from DC through 5 mc within $\pm 1\frac{1}{2}$ db. Sensitivity 10 mv/inch. Bridge-type positioning; Return trace eliminato; External, internal positive or negative sync; Linear sweep from 1 cycle to 80 kc; Square-wave calibrator and pot. for using scope as Peak to Peak VTVM; Edge-illuminated scale and green filtered screen. Special low loss components. Steel cabinet with deeply etched aluminum panel and reinforced chassis construction. Complete with instruction book and all components. 11" x 14" x 19". Shpg. wt., 36 lbs.

MODEL 308K — KIT, complete Net 129.50
MODEL 308W — Factory wired Net 229.50



PRECISE PROBES

MODEL 999 HIGH VOLTAGE PROBE: Changeable tips, shockproof, multi-insulation, swivel mount. Wired only 6.98
MODEL 912 R.F. PROBE: RMS readings thru 250 mc; for VTVM's, VOM's and Scopes. Wired only 4.25
MODEL 960 — 10 to 1 CAPACITY ATTENUATOR PROBE: Thru 100 mc, Less than 7 mmfd input. Wired only 5.95



PRECISE MODEL 111K TUBE TESTER KIT

- THE ONLY TUBE TESTER BELOW \$950.00 THAT CHECKS TUBES THE WAY THEY'RE TESTED AT THE FACTORY!
- CHECKS FOR BOTH EMISSION AND MUTUAL CONDUCTANCE—TWO TESTERS IN ONE!

A truly outstanding engineering achievement in a tube tester kit! The specialized tube gets tested for its specialty as well as generally. Latest type anti-backlash roll bar indicates the most important single test for normal applications. Tests all receiving and cathode ray tubes for both emission and mutual conductance. Filament current and tube bias of conventional and series filament tubes are measured directly on the meter. Features rotary type switches to cover all tube elements, gas check, and ultra-convenient single switch short check. Has space switch for future tube types. Rugged steel cabinet with deeply etched aluminum panel. 3-color, step-by-step instruction manual. For 110-120V, 60 cycle AC. 14" x 18" x 6". Shpg. wt., 25 lbs.

MODEL 111K — KIT, complete with cover Net 79.95
MODEL 111W — Factory wired Net 139.95
CRT ADAPTOR — PTA-K — Kit Net 2.95
PTA-W — Factory Wired Net 4.25

PRECISE MODEL 909 VACUUM TUBE VOLTMETER

- BURN-OUT PROOF CIRCUIT
- SPECIAL TRUE ZERO ALIGNMENT SCALE FOR FM & TV DISCRIMINATORS



A true Precise achievement with every part, no matter how small, the right part for the job. Features 1% or better ceramic precision resistors; special, separate 5 Volt AC scale for accuracy on low voltages; 25 megohm input impedance at DC. Ranges: +DC 0-5-25-250-500-1000 volts; —DC 0-5-25-250-500-1000 Volts; AC 0-5-25-250-500-1000 Volts; Ohms Rx1 Rx10 Rx1000- Rx10,000-Rx1,000,000 Ohms, from 2 Ohms to 1 Billion Ohms; from —20 to +55 DB. Uses 6SN7, 6AL5, 6X5. Extra large 4-1/2" meter. Up to 250 megacycle range with Model 912 Probe; Up to 30,000 Volts with Model 999 High Voltage Probe. Attractive steel cabinet with deeply etched panel. Complete with test leads, internal battery, and specially prepared 3 color SPEED instruction book that explain each step. For 105-120 Volt; 50-60 cycles, AC. 9 1/2" x 6" x 5"; Shpg. wt., 10 lbs.

MODEL 909K — KIT, complete Net 25.98
MODEL 909W — Factory wired Net 37.50

PRECISE MODEL 630-KA RF-AF-TV MARKER GENERATOR KIT

- 110 Mc on FUNDAMENTALS, 330 Mc on HARMONICS!
- PRECISION ENGINEERED FOR TV, AM and FM ALIGNMENT
- WITH FACTORY PREASSEMBLED AND CALIBRATED RF HEAD



Features Wien Bridge AF oscillator; Colpitts RF oscillator; audio of 20-20,000 cycles; cathode follower output; stepping attenuator; external modulation; speech amplifier; crystal marker; pre-tuned RF head; crystal amplitude control; RF and AF stand-by; separate RF section; constant output impedance. Other features include vernier tuning on RF and AF, individually tuned coils, and complete shielding. Deeply etched alum. panel; wrinkle steel cabinet with genuine leather handle. For 110-120 volts, 60 cycle AC. 8" x 11" x 5". Shpg. wt., 17 lbs.

MODEL 630KA — KIT, complete Net 38.95
MODEL 630W — Factory wired Net 53.95



NEW DC WIDE BAND EICO MODEL 460K 5" OSCILLOSCOPE
COLOR AND MONOCHROME LABORATORY AND TV SERVICE SCOPE LIFETIME GUARANTEE! • 5 MC BANDWIDTH AND DC AMPLIFIERS!
 Flat from DC to 4.5 mc for reproduction of 2.5K mc wave burst and modulated signals in color TV sets. Vertical amplifier direct-coupled and push-pull throughout. Cathode follower between stages. High vertical sensitivity—25 millivolts per inch. Balance of an additional input. Four step frequency-compensated attenuator in both AC and DC positions. Accurate direct peak-to-peak voltage measurement—automatic zero limiter and amplifier-drive fuses automatically synchronized. Pre-set TV V and H sweep positions—100 cps and 7-75 cps. Edge-lit oscilloscope graph 5 in. screen with dimmer control. Controls on convenient desktop extend from front panel. Can be built at home without special equipment or special knowledge. Truly an unmatched engineering achievement for your test bench.
 Size: 11" x 8" x 6". H: 13". Wt.: 50 lbs.
MODEL 460K — Oscilloscope Kit Net 79.95
MODEL 460 — As above, but factory wired. Net 129.50

MODEL 221 VACUUM TUBE VOLTMETER



Variable top-quality laboratory-precision VTVM for rugged-fast operation and lifetime dependable service. 13 different ranges. Large rugged 4 1/2" meter, can't-burn-out circuit. New zero center for TV & FM discriminator alignment. Electronic AC & DC ranges: 0-5, 10, 100, 500, 1000 v, 30,000 volts and 200 mC with HVP-1 and P-75 probes. Ohmmeter ranges, 2 ohms to 1000 meg. DB scale. New stable double-tube balanced bridge circuit—extreme accuracy. 26 meg. DC input impedance. Attractive 3-color etched rubberproof panel; rugged steel case, 11 1/2" x 9" x 6". Shipping Weight, 10 lbs. Includes all parts and tubes.
Eico Model 221-K — Kit, complete, Net Each \$25.95
Eico Model 221 — Factory wired, Net Each 39.95

MODEL 232K PEAK-TO-PEAK VACUUM TUBE VOLTMETER



• THE NEW LEADER IN PROFESSIONAL PEAK-TO-PEAK VTVMs
 • WITH THE SENSATIONAL AC/DC UNI-PROBE!
 Measures directly peak-to-peak voltage of complex and sine waves: 0-4, 14, 42, 140, 420, 1400, 4200, 30.0CRMS sine waves: 0-1, 2, 5, 15, 45, 150, 500, 1500 (up to 30,000 volts with HVP probe), 5 to 250 mc with PRF probe; Ohms: 0.2 ohm to 1000 meg. 7 non-skip ranges on every function. Calibration without removing from cabinet. 4 1/2" meter, can't-burn-out circuit. Zero center, 1-5 multiplier. With sensational new AC/DC Uni-Probe that performs all functions. Exceptional stability and accuracy. Size: 8 1/2" x 6" x 5". Shpg. wt., 7 lbs.
Model 232K — Kit, complete Net 29.95
Model 232 — As above, but factory wired Net 49.95

MODEL 360K TV-FM SWEEP SIGNAL GENERATOR



Covers all TV and FM alignment frequencies between 500 kc and 228 mc used with any standard scope. Sweep width variable from 0-30 mc. Crystal marker oscillator with variable amplitude. Provision for external marker. Phasing control included. Vernier dial calibrated in frequencies. Tubes: 6XSGT, 1-12AU7, 2-6C4. For 110-120V., 60 cycles AC. Size: 10x8x4 1/2". Complete with tubes, steel case, etched panel, parts, schematic and pictorial diagrams. Less crystal. Shpg. wt. 10 lbs.
Eico Model 360K Sweep Signal Generator Kit 24.95
Model 360 — As above, but factory wired 49.95

MODEL 320K SIGNAL GENERATOR



For FM, AM alignment and to provide TV marker frequencies. Highly stable Hartley oscillator has range of 150 kc to 102 mc with fundamentals to 34 mc. Choice of unmodulated or 400-cycle AM modulated output. 7 bands. Vernier tuning condenser. Supplied complete with tubes, portable steel case, panel, parts, schematic and pictorial diagrams. Size: 10x8x4 1/2". For 110-120V., 60 cycles AC. Shpg. wt. 10 lbs.
Eico Model 320K Signal Generator Kit 19.95
Model 320 — As above, but factory wired 29.95
Model 322K — Similar Kit to Model 320K except with individual calibration of each of its 5 bands. 23.95
Model 322 — Same as Model 322K except factory wired. 34.95

MODEL 315K DELUXE SIGNAL GENERATOR



Range 75 kc to 150 mc on 7 calibrated bands. Accuracy better than 1%, stabilized by VR power supply circuit. Supplies RF, modulated RF or AF. 4-step RF output multiplier, constant output impedance. 400-cycle sine wave modulation. Bandspread, vernier tuning, illuminated dial. Tubes: 6C4, 7F7, 6X5, VR-150. For 105-130V., 60 cycles AC. Size: 12x13x7". Supplied with tubes, steel case, parts, schematic and pictorial diagrams. Shpg. wt. 20 lbs.
Eico Model 315K Signal Generator Kit 39.95
Model 315 — As above, but factory wired 89.95

EICO MODEL 324K RF SIGNAL GENERATOR

• Now one generator covers whole range of 150 kilocycles to 435 megacycles!
 For IF-RF alignment, signal tracing and trouble-shooting of TV, FM, AM sets all on fundamentals; marker generator for alignment of new hi-f and older hi-f TV's. 400 cps sine wave audio testing. Range: 150kc-145mc on fundamentals—11-435 mc on calibrated harmonics. Accuracy: ± 1% frequency accuracy. Variable depth of internal modulation 0-50% by 400 cps. Colpitts oscillator. Variable gain external modulation amplifier; approx. 3 volts for 30% modulation. Tuner-mounted, slug-tuning, centering. RF output 100,000 microvolts, AF output up to 10 volts. Size: 8 1/2" x 10 1/2" x 4 1/2". Shpg. wt. 10 lbs. For 105-120 V. AC 50/60 cps.
Model 324K — Kit, complete NET 26.95
Model 324 — Factory wired and tested NET 39.95

MODEL 147K DeLuxe Multi-Signal Tracer



Unsurpassed facilities for RF/IF audio signal tracing and trouble shooting AM/FM/TV sets. Simultaneously observe 3 patterns on 1 scope: compare voltage and current amplitudes, wave forms, frequencies and phase relationships; set up voltage reference level, etc. Separate high gain RF and low gain audio input channels. Magic eye monitors both channels in addition to speaker for signal tracing. Continuous current-monitored, slug-tuning, centering, range from 10 to 2000 cps. With shielded RF demodulator and audio probe. For 105-125V AC, 50/60 cps. 25 watts. Size: 6 1/2" x 8 1/2" x 5". Shpg. wt., 7 lbs.
Eico Model 147K DeLuxe Multi-Signal Tracer Kit NET 24.95
Model 147 DeLuxe — Above, but factory wired. NET 39.95

EICO BUILD YOUR OWN INSTRUMENTS

MODEL 425K 5" OSCILLOSCOPE

New, improved laboratory precision oscilloscope kit, engineered to give you extra sensitivity and range. Has push-pull deflection and 0-1 Rms volt high sensitivity. Wide range, at least 2 cps to 200 cps, with full gain of TV, FM and AM receiver. Range, at least 2 cps to 200 cps, available with 25 megohm VTM. Direct comparison of plates of CRT. Available to 75,000 cps. Z axis intensity modulation. Tubes 4 6X5, 2-6J5, 2-6X8, 6BH7 CRT. For 110-120V., 60 cycles AC. Supplied complete with portable steel case, etched panel, parts, schematic and pictorial diagrams. Size 8 1/2" x 11 1/2" x 7 1/2". Shpg. wt. 22 lbs. Nothing else to buy!
Eico Model 425K Oscilloscope Kit 44.95
Model 425 — As above, but factory wired. Net 79.95

EICO MODEL 377K SINE & SQUARE WAVE AUDIO GENERATOR

• AN EXCELLENTLY DESIGNED GENERATOR THAT REPLACES TWO SEPARATE INSTRUMENTS FOR LESS THAN THE PRICE OF ONE!
 Wien Bridge tuning circuit; 1% resistors and 4-gang condenser. Frequency range: Sin wave, 20-200,000 cps; square wave, 60-50,000 cps. Response ± 1.5 db, 60-150,000 cps. Distortion less than 1%. Hum less than 0.4%. Accuracy ± 3%. Output: 10 volts across 1000 ohm rated load (100 mw), Sine: 7 1/2" x 11 1/2" x 7 1/2". Shpg. wt. 11 lbs.
Model 377K — Kit, complete Net 31.95
Model 377 — As above, but factory wired and tested Net 49.95

EICO FLYBACK TRANSFORMER & YOKE TESTER

Positive check of all types flyback and yokes, in or out of set—100% accuracy! Operates on the extremely sensitive grid-dip principle—shows up even 1 shorted turn. Exclusive calibration for air core and iron core flybacks for accurate testing of all types. Checks any inductance whose impedance is not too low. Large easy-to-read 4 1/2" meter. 3 separate colored scales. Tests continuity of sockets, coils, speakers, switches, etc. New compact size for easy portability (7" x 5" x 4"). Smart professional styling—New satin finish etched panel with contrasting knobs and meter and grey wrinkle steel case. Kit comes complete with easy-to-follow instructions.
Eico Model 944-K — Kit, Complete Net 23.95
Eico Model 944 — As above, but factory wired Net 34.95

MODEL 625K TUBE TESTER

Features inter-connection switches for testing each tube element. Tests all standard AM, FM and TV tubes including 9-pin miniature, V2, magic eye and pilot bulbs. Large, 4 1/2" meter has colored markings to indicate condition of tube. Illuminated roll chart gives tube test settings at a glance. Has two leads with grid-cap connectors. Also tests for shorts and open elements. Projects overload pilot bulb. Built-in power supply. For 115V., 60 cycles AC. Supplied with portable steel case, etched panel, parts, etc. Size: 12 1/2" x 9 1/2" x 4 1/2". Shpg. wt. 13 lbs.
Eico Model 625K Tube Tester Kit 34.95
Model 625 — As above, but factory wired 49.95

PICTURE TUBE ADAPTER

Model ORA. Adapts 625-K and 625 Tube Testers for checking all sizes of TV picture tubes. Measures cathode emission; tests for filament continuity; shorts between elements. Complete with standard 12-pin socket, octal plug-in connector and 4-ft. cable to permit testing tube without removal from set. Shpg. wt. 2 lbs.
MODEL ORA ADAPTER NET 4.50

MODEL 950 BK R.C. BRIDGE & R-C-L COMPARATOR

• EXCELLENT VALUE, HIGHLY DEPENDABLE!
 Latest bridge-type instrument directly reads 0.5 ohms — 500 mega resistance (1 range); 10 mfd — 5000 mfd capacitance (4 ranges); and power factor. Kit includes precision calibrating resistor. Unique comparator range for R.C. & L comparison measurement against external standard. Leakage testing of all capacitors at rated dc working voltage with internal 0-500 vdc source. Electron-ray tube as both bridge balance and capacitor indicator. Attractive, durable case, neat easy-to-read character. Size: 8" x 10" x 4 1/2". Shpg. wt. 8 lbs.
Model 950B-K — Kit, complete NET 19.95
Model 950B — As above, but factory wired NET 29.95

EICO MODEL 1050 BATTERY ELIMINATOR AND CHARGER

Battery eliminator for bench testing and servicing 6V or 12V car radios. Charger for 6V or 12V batteries. DC output: 0.8V or 0-10V; 6V-12V toggle switch. Current rating at 0.8V: 10A continuous; 20A intermittent. Current rating at 0-10V: 3A continuous, 12A intermittent. Continuous voltage adjustment with Variac-type transformer. Separate voltmeter and ammeter. Fused primary, automatic safety interlocking for secondary. Input: 105-125 V.A.C., 50-60 cps. Power: 150 watt Eutec blue-gray hammerstone steel cabinet; may be wall mounted. Overall dimensions: 10 1/2" x 7 1/2" x 8 1/2". Wt. 15 lbs.
Model 1050 KIT NET 29.95
Model 1050. As above, but factory wired and tested. NET 38.95
Model 1040 KIT. 6V Battery Eliminator and Charger. NET 25.95
Model 1040. As above but factory wired. NET 34.95

DESCRIPTION	KIT	Factory		
		Net	Wired	
Scope Demodulator Probe	PSDK	3.75	5.75	
Scope Direct Coupling Probe	PDK	1.75	3.75	
Scope Low Capacity Probe	PLCK	3.75	5.75	
Set of 3 Scope Probes		9.95	14.95	
Peak-to-peak probe for 11 megohm VTM	PTPIIK	4.95	PTP-11	6.95
Peak-to-peak probe for 25 megohm VTM	PTP25K	4.95	PTP-25	6.95
R.F. Probe for 11 megohm VTM	PRF11K	3.75	PRF-11	4.95
R.F. Probe for 25 megohm VTM	PRF25K	3.75	PRF-25	4.95
*30 KV H.V. Probe (Wired only)			HVP-1	4.95
*30 KV H.V. Probe (Wired only)			HVP-2†	6.95

EICO UNI-PROBE

New Uni-Probe, a half-turn of probe-tip selects VTM DC or AC-OHMS. Uni-Probe Kit NET 5.95
 Uni-Probe — Factory wired 6.95

*Specify make and model of instrument.
 †For all VTM or 20,000 ohm/volt V.O.M.

AND DON'T FORGET LAFAYETTE'S MONEY BACK GUARANTEE

LAFAYETTE'S SPECTACULAR MULTITESTER VALUES

**HIGH SENSITIVITY 20,000 OHM PER VOLT DC
10,000 OHM PER VOLT AC MULTITESTER**

19.95

LOOK AT THESE FULL SCALE RANGES!

D.C. VOLTS: 0-6; 0-30; 0-120; 0-600; 0-1200;
0-6000 Volts—A.C. VOLTS: 0-6; 0-30; 0-120;
0-600; 0-1200 Volts—RESISTANCE: 0-10K; 0-100K;
0-1 Meg; 0-10 Megohms—D.C. CURRENT: 0-60
Microamp; 0-6; 0-60; 0-600 Milliamps—DECIBEL:
-20 to +17 db (0 db = 0.774V)—CAPACITY:
.0001 - .01; .005 - .15 mfd—INDUCTANCE: 20-
2000 millihenry—OUTPUT RANGES: 0-6; 0-30;
0-120; 0-600; 0-1200 Volts

The new Lafayette high sensitivity Multitester is a complete instrument (not a kit). In addition to its unusual sensitivity of 20,000 OHMS PER VOLT ON D.C. AND 10,000 OHMS PER VOLT ON A.C., and the extraordinary number and scope of its ranges, it is packed with features that would make it cost at least twice as much if made in this country. Uses 1% precision resistors, silver contacts on selector switch, 35 ua 3" meter. Dependable, rugged and accurate. Even the test leads are heavy duty with high voltage insulation. Voltage source required for low capacity range is 120V A.C. for high range capacity and inductance scale is 6V A.C. Attractive plastic front with metal bottom. Size: 4 1/4" x 4 1/4" x 2 1/2". Complete with batteries and leads. Shipping weight 4 1/2 lbs.

RW-30A Singly, Each 19.95
In lots of 3, Each 19.25

NEW POCKET AC-DC VOM MULTITESTER
2,000 Ohm per Volt Sensitivity on both DC and AC

**160 ua 3" METER
1% PRECISION RESISTORS
SILVER CONTACT SELECTOR
SWITCH**

7.95

FULL SCALE RANGES

DC Volts: 0-10; 0-50; 0-500; 0-1000 Volts —
AC Volts: 0-10; 0-50; 0-500; 0-1000 Volts —
DC Current: 500 ua and 500 ma—Resistance:
0-10K; 0-1 Meg—Decibels: -20 to +22;
+20 to 36 db (0 db = 0.775 V) — Capacity:
250 mmd to .2 mfd — .005 mfd to 1 mfd —
Output Ranges: 0-10; 0-50; 0-500; 0-1000 volts

Best Buy In America! A very accurate and sensitive VOM. This Multitester is a complete instrument (not a kit) with high quality and sensitive 160 microamp meter; 2000 ohm per volt on both AC and DC. Single selector switch, 1% precision resistors, 3" meter. Features extreme versatility, accuracy and ruggedness. In attractive plastic front panel, with metal bottom for ruggedness and shielding. First capacity range requires 50 volt AC source. Second capacity range requires 10 volt AC source. Size 4 1/4" x 3 1/2" x 1 1/4". Complete with test leads and batteries. Shipping weight 4 lbs.

RW-27A Complete 7.95

Sensitive Pocket AC-DC Multitester With Both Capacitance and Inductance Ranges

- 100 UA 3" METER
- 1% PRECISION RESISTORS
- INDUCTANCE RANGE
- CAPACITANCE RANGE
- 2000 OHMS PER VOLT SENSITIVITY ON BOTH DC AND AC
- SILVER CONTACT SINGLE SELECTOR SWITCH

12.95

FULL SCALE RANGES
AC VOLTS: 0-6, 0-12, 0-60, 0-300, 0-1200 VOLTS. DC VOLTS: 0-6, 0-12, 0-60, 0-300, 0-1200 VOLTS. DC CURRENT: 0-300 UA, 0-3 MA, 0-300 MA. RESISTANCE: 0-10K, 0-100K, 0-1 MEGOHM. DECIBELS: -20DB to +15DB, +17DB to +37DB. CAPACITANCE: 250 MMFD to .1 MFD. INDUCTANCE: 0-1000 Henries.

An exceptional value in a convenient accurate, complete instrument at a price lower than that of kits not having comparable features. The 20 full-scale ranges are chosen by a single silver contact selector switch. A simply installed 1 1/2 V penlight cell provides an internal source for resistance measurements. The instrument has a sensitivity of 2000 ohms per volt on both DC and AC and employs precision 1% tolerance resistors. The DB scales are calibrated for use across 600 ohm lines. The capacity range requires an external 60 volt AC source. The inductance scale requires an external 6 volt AC source.

Extremely versatile and compact instrument with a beautiful plastic front panel in a metal case to provide ruggedness and shielding. Size: 3 3/4" x 5 1/2" x 1 3/4". Complete with batteries and test leads. Shpg. wt., 3 lbs.

RW360A

In lots of 3 12.45 Singly, Ea. 12.95

ANOTHER OUTSTANDING LAFAYETTE VALUE

• Most advanced engineering to fit the Serviceman's needs.

• Priced to fit the Serviceman's Pocketbook.

TUBE TESTER!

26.95

OPERATING INSTRUCTIONS FOR MODEL TC-55 TUBE TESTER

A new streamlined tube tester with a realistic approach to the problem of quickly testing the ever increasing number of tube types. It incorporates new and advanced engineering features and all at a price of about half of even the most ordinary tube tester. Read these Specifications.

"FREE POINT" ELEMENT SELECTOR SWITCHING: Newly designed, it reduces possibility of obsolescence to a minimum because any pin may be used as a filament pin and voltage applied between it and any other pin, or even the "top cap". Tubes with tapped filaments or with filaments terminating in more than 1 pin are truly tested.

MULTIPURPOSE TUBES: Special isolating circuit allow each section of multi-purpose tubes to be tested individually as if it were in a separate envelope.

SHORTS AND LEAKAGES: Supersensitive method checks shorts and leakages up to 5 megohm between any and ALL elements; continuity between various sections individually indicated.

SIMPLICITY: Fast simple operation. The 4 position fast action snap switches are all numbered in exact accord with RMA standards. Thus when testing element terminating in pin No. 7 of a tube—you use button No. 7. You can't insert a tube in the wrong socket—there's one for each type of tube base.

TUBE TYPES: Tests all octal, loctal, 7 pin miniatures, 9 pin miniatures as well as the new novel and Sub-Minor types. Old type sockets used for testing obsolete types—that you rarely see anymore—have been eliminated.

SIZE: A practical size to carry with you as well as for use in the shop—only 8 1/2" x 6 1/2" x 2 1/4" deep. Shpg. Wt. 5 lbs.

MODEL TC-55—complete with carrying case and instructions. 26.95

CRT TUBE TESTER 15.85

A complete picture tube tester. Has self-contained built in power supply. Tests all magnetically deflected picture tubes from 7 to 30 inches either in the set or out of the set. Tests for quality by emission method. All readings on "Good-Bod" scale. Tests for inter-element shorts and leakages up to 5 megohms—tests for open elements. Operates on 110VAC. Bakelite case. Size 6x2 1/4" x 3 1/2". Shpg. Wt. 3 lbs. Superior TV-40. Net 15.85

TRIPLETT MINIATURE VOM

- 20,000 OHMS PER VOLT AC
- 5,000 OHMS PER VOLT DC
- 18 RANGES

Handsome pocket sized highly sensitive instrument. RANGES: DC Volts: 0-3-12-60-300-1200; AC Volts: 0-3-12-60-300-1200; DC Current: 0-600 Uo and 0-6-60-600 Ma; Ohms: 0-20,000 - 200,000 - 2 meg - 20 meg with center scales of 200-2000-20,000 and 200,000 ohms. A convenient output short is included. Basic meter is 0-50 uo. Dial scale 2 1/8" long at top arc. Slide type selector switch. Black molded case 2 3/4" x 4 1/4" x 1-3/16" with transparent meter window. 24" test leads with interchangeable tip. Complete with batteries and leads. Shpg. wt. 3 lbs.

TRIPLETT 310 METER 28.91
TRIPLETT 369 CARRYING CASE 2.84

NEW! LAFAYETTE SIGNAL GENERATOR

22.50
complete



NEVER BEFORE HAS A COMPLETELY WIRED AND TESTED INSTRUMENT OF SUCH ACCURACY AND QUALITY BEEN OFFERED AT SUCH A PRICE!



INTERIOR VIEW

- FREQUENCY 120 KC TO 260MC
- 120KC TO 130 MC ON FUNDAMENTALS
- LABORATORY ACCURACY AND QUALITY

This completely wired and tested instrument is not to be confused with — or even compared to — units sold in kit form at almost the same price. This is a precision instrument of a quality and accuracy that puts it in the class of instruments 3 to 4 times its price. Six overlapping ranges generate signals of 120KC — 320KC, 320KC — 1000 KC, 1MC — 3.2 MC, 3.2 MC — 11 MC, 11MC — 38MC and 37MC — 130MC all on fundamentals with calibrated harmonics from 120MC to 260MC. Selector switch gives instant choice of ranges. Switch gives choice of internal modulation of 400 CPS or use of any external source at other frequencies. For audio testing the 400 cycle signal can be used separately. Outputs are unmodulated RF, modulated RF and 400 CPS audio. RF output is in excess of 100,000 microvolts and jacks are provided for choice of either high or low RF output. Stability is insured by circuit which uses a 12BH7 twin triode cathode follower — buffer and a 6AR5 AF oscillator. Has a fine adjustment RF control. AF output is 2-3 volts. AF input is 4 volts across 1 megohm. Large clear 5 inch etched dial plate and pointer are protected by transparent acril plastic bezel. Common AF terminals for EXT-MOD input and INT-AF for audio tests eliminate need for special AF output connectors. Machine engraved panel lettering. Handsome gray metal case with carrying handle. Measures 6½" x 10" x 4½". Comes complete with pair of leads, AC line cord and plug. Operates on 105-125V 50-60 cycle AC. Shpg. wt. 8 lbs.

LAFAYETTE LSG-10 SIGNAL GENERATOR

22.50

20,000 OHM PER VOLT MULTITESTER SEMI KIT

A New Kind of Kit



THE
DIFFICULT
WORK IS
ALREADY
DONE

YOU
WIRE
IN
ONLY
A
FEW
PARTS

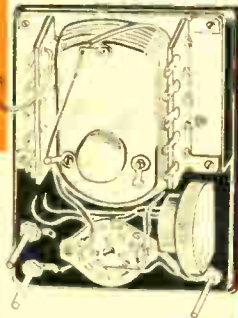

11.95

- 20,000 OHM PER VOLT DC — 5,000 OHM PER VOLT AC
- 40 UA 3" D'ARSONVAL METER
- HIGH INPUT RESISTANCE ON ALL DC AND AC RANGES

The semi-kit is a new concept in test equipment kits. The meter, rotary selector switch, ohms adjust control, terminal strips and studs all are already mounted on the front panel, with most of the wire leads from the switch in place with one end free. All that remains to be done is to mount the battery holder and wire in the multipliers and resistors, a job so simple you'll finish before you realize it, and best of all, you'll have one of the finest high sensitivity multitesters on the market. Ranges: DC VOLTS 0-10, 50, 250 and 1000; AC VOLTS 0-2.5, 10, 250 and 1000; DC CURRENT: 0-100 UA and 250 MA; DC RES: 0-50000 — 500,000 — 5 Megohm with center scales of 50, 5000 and 50,000 ohms; DECIBEL: —20 to +10 db and —8 to +22.

When used in a circuit, the high input resistance on all DC and AC ranges does away with the highly inaccurate readings common to low resistance testers which load the circuit. Black bakelite molded case size 3½" x 4¾" x 1½". Complete with test leads, all parts and complete instructions. Shpg. wt. 3 lbs.

TK-20—KIT

11.95

SHURITE METERS



Model 550



Model 950

Economy model panel meters of good quality and accuracy. Model 550 is round and equipped with a clamp. Model 950 is square and flange mounted. Both models require a 2-5/32" hole. "H" indicates high resistance "Z" indicates sensitive type with zero adjustment. Average shpg. wt. 2 lbs.

RANGE	MODEL 550 ROUND		MODEL 950 SQUARE	
	STOCK NO.	NET	STOCK NO.	NET
DC VOLTMETERS				
0-1	5101	1.76	9101	1.81
0-3	5102	1.76	9102	1.81
0-8	5106	1.76	9106	1.81
0-10	5107	1.76	9107	1.81
0-15	5108	1.76	9108	1.81
0-25	5109	2.06	9109	2.11
0-50	5122	2.21	9122	2.25
0-100	5113	2.21	9113	2.25
0-150	5115	2.25	9115	2.30
0-300H	5117	3.09	9117	3.14
0-500H	5118	3.33	9118	3.38
AC VOLTMETERS				
0-15	5404	2.89	9404	2.94
0-50	5405	3.48	9405	3.53
0-150	5406	3.48	9406	3.53
0-300	5407	4.12	9407	4.17
DC MILLIAMMETERS				
0-1	5300Z	3.38	9300Z	3.43
0-3	5301	2.50	9301	2.55
0-5	5302	2.25	9302	2.30
0-10	5303	2.11	9303	2.16
0-15	5304	1.81	9304	1.86
0-25	5305	1.76	9305	1.81
0-50	5306	1.76	9306	1.81
0-100	5307	1.76	9307	1.81
0-150	5308	1.76	9308	1.81
0-200	5309	1.76	9309	1.81
0-300	5310	1.76	9310	1.81
0-400	5311	1.76	9311	1.81
AC MILLIAMMETERS				
0-10	5407	3.19	9607	3.23
0-50	5402	2.89	9602	2.94
0-100	5403	2.89	9603	2.94
DC AMMETERS				
0-1	5201	1.76	9201	1.81
0-3	5202	1.76	9202	1.81
0-5	5203	1.76	9203	1.81
0-10	5205	1.76	9205	1.81
0-25	5207	2.21	9207	2.25
0-50	5208	2.40	9208	2.45
10-0-10	5213	2.21	9213	2.25
20-0-20	5214	2.25	9214	2.30
50-0-50	5216	2.50	9216	2.55
AC AMMETERS				
0-1	5501	2.84	9501	2.89
0-3	5502	2.84	9502	2.89
0-5	5503	2.84	9503	2.89
0-10	5504	2.84	9504	2.89
0-30	5505	3.09	9505	3.14
0-50	5506	3.28	9506	3.33
RESISTANCE METERS				
10,000 OHMS				
4.5V	5701	2.35	9701	2.40

FLANGE ADAPTER RING FOR ROUND METERS
MODEL 5A—2½" Black Finish 18¢

TEST EQUIPMENT

B & K 400 PICTURE TUBE REJUVENATOR TESTER

• NOT ONLY TESTS BUT REPAIRS TOO!



Now it's easy to save thousands of weak and inoperative TV picture tubes. Designed expressly for the service man's use — either in the shop or the customer's home. Quickly and accurately checks any make or model of TV picture tube, and instantly determines if tube is good or bad. All troubles which arise. It restores emission and brightness, removes shorts, repairs open circuits, grid cut-off, gas content and probable useful life. The Model 400 will repair up to 50% of the troubles which arise. It restores emission and brightness, removes shorts, repairs open circuits, etc. No need to remove picture tube from set when making repairs. Maroon leatherette-covered plywood carrying case. Size: 5 1/2" x 7 1/2" x 11". Has 3" meter. For 110-120 volt 50 cycles. Shpg. wt., 5 lbs. NET 53.85

B & K 400 NET 53.85

B & K MODEL 200 ECONOMY REJUVENATOR TESTER

Same as Model 400 except has 3" meter, common short indicator, and less grid bias cutoff feature. NET 39.15

MODEL 200

B & K DYNA-QUIK

MODEL 500

DYNAMIC MUTUAL CONDUCTANCE TUBE TESTER

- A LABORATORY ACCURATE TUBE TEST RIGHT IN THE HOME IN AS LITTLE AS 12 SECONDS!
- MORE ON-THE-SPOT TUBE SALES—LESS COSTLY CALL-BACKS!

Tests TV tubes including 600 mil series under actual operating conditions for dynamic mutual conductance, shorts, grid emission, gas content, leakage and life expectancy. One switch tests everything — no need for roll charts or multiple switching. Has large, easy-to-read 4 1/2" plastic meter calibrated 0-5,000 and 0-18,000 microhms. Tube types are listed on inside of cover and most often used tubes are listed directly on tester panel. New tube test procedure supplied by factory at regular intervals. Has automatic line compensation and 7-pin and 9-pin straighteners. Handsome, rugged, luggage style carrying case, covered in durable, black leatherette; removable slip-hinged cover. Size: 15 1/2" x 4 1/2" x 5 1/2". For 105-125 volts, 60 cycle AC. Shpg. wt., 13 lbs. MODEL 500 NET 107.75

SPRAGUE KWICK-TEST CAPACITOR CHECKER



A manual for technicians who service TV receivers. Tests capacitors while they are wired in the set. No need to remove them from the circuit. The KT-1 will check by-pass, blocking and coupling capacitors from 30 mfd to 2000 mf. Simply press a button and the "magic eye" tells you if a capacitor is open, shorted or intermittent. Will even work when a resistor is wired in parallel with the capacitor under test. Perfect companion item to the Sprague Tel-Ohmike. Light weight—only 3 1/2" x 8 1/2" x 5". Shpg. wt. 8 lbs.

SPRAGUE KT-1... NET 33.81

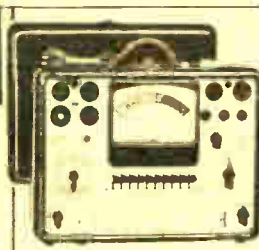

TRIPLET 3413-B TUBE TESTER

FOR FASTER, FLEXIBLE TUBE TESTING

Latest model tube tester provides conclusive tests of all receiving tubes, gaseous rectifiers, and new series filament tubes (with adapter) for quality, inter-element shorts or leakage. Neon short test shows slightest inter-element short or leakage. In-circuit resistance meter. Speed-Roll tube chart. Complete in counter-portable metal case with removable hinged cover; baked-on black enamel finish. 115 Volts, 50-60 cycle, A.C. 15 1/2" x 11 1/2" x 6 1/2". Shpg. wt., 22 lbs. NET 77.91

while cathodes are hot. New 3-position lever switches for complete control of each tube element. Provides short and continuity test for resistors, ballast tubes, pilot lamps, appliances, etc. Full range of filament voltages from .63 to 110 volts in 19 steps. Big 3" Red Dot lifetime guarantee meter. Speed-Roll tube chart. Complete in counter-portable metal case with removable hinged cover; baked-on black enamel finish. 115 Volts, 50-60 cycle, A.C. 15 1/2" x 11 1/2" x 6 1/2". Shpg. wt., 22 lbs. NET 77.91

BY ADAPTER — FOR TV PICTURE TUBE AND CRT TESTS. Check picture tubes right in set or carton. Can be used with Triplet Models 3413-B, 3423, 2413, 3212, 3413 and 3413-A TRIPLET T-2247-BV. NET 41.11

PRECISION MODEL E-200-C SIGNAL-MARKER GENERATOR

PROFESSIONAL PERFORMANCE

• 88 KC to 240 MC for AM, FM and TV

88 20

The outstanding generator in its class. 88 KC to 240 MC. 6 1/2" Dial direct reading in 9 bands to 240 MC. 1% accuracy on all bands. 0-1000 Vernier Scale: 500 cycle sine wave audio oscillator — over 500 volts output; dual RF Attenuators; vital components shielded — AC line is RF filtered; 4 signals: "Externally Mod. RF," "100 cycle Mod. RF," "Externally Mod. RF," "400 cycle Audio Output"; 0-100% modulation control; built-in AVC-AGC substitution for overcoming alignment troubles. Excellent for alignment and "Service by Signal Substitution." Black ripple finished cabinet with anodized alum. panel. 10 1/2" x 12" x 6". For 110-120 volts, 50/60 cycles. Complete with tubes, cable and "Service by Signal Substitution" manual. NET 88.20

E-200-C Deluxe — satin brushed, anodized aluminum panels, custom molded knobs, color-etched characters, blue-gray ripple cabinet. Shpg. wt., 17 lb. NET 93.10



TRIPLET 630 MULTITESTER

Dual, high sensitivity multimeter: 20,000 ohms/volt DC; 500 ohms/volt 120 AC; 10 and AC volt ranges: 0-3/12/60/300/1200/6000. DC current: 0-60 microamps; 0-1/2/12/120 ma.; 0-15 amps. Resistance: 0-1000/10,000 ohms; 0-1 meg/100 meg with center scale of 4.7/44/44,000/440,000 ohms. Six direct reading db ranges: Rated +30 to +70. Capacitor in series with AC volt ranges. Single rotary switch. Black molded plastic case. 3-7/32" x 5 1/2" x 2 1/4". Complete with batteries and test leads. Triplet Model 630. Shpg. wt. 6 lbs. NET 38.71

TRIPLET MODEL 630-A Same as Model 630 except has long, mirrored scales that eliminate parallax in readings, and special 1% resistors for greater accuracy. MODEL 630-A NET 48.51

MODEL 639 Leather carrying case for 630, 630A, 630NA, 630T, 631. Net 8.33

NEW SENCO MODEL BE-2 ALIGN-O-PAK TV BIAS SUPPLY

A MUST FOR SERVICEMEN AND SHOP. Invaluable for more accurate TV alignment. A complete variable power supply that provides the rugged, accurate bias voltage for AGC line. Eliminates need for bias batteries. Calibrated for 0 to 10 volts DC. AC ripple of less than 1/10th of 1%. Completely isolated. A low cost highly useful accessory for the serviceman and shop. Attractive gray hammertone enamel case. For 110-120V, 60 cycle AC. Complete with 28" leads with alligator clips. 2 1/2" x 4 1/4" x 3". Shpg. wt., 2 lbs. MODEL BE-2 NET 7.69

SIMPSON MODEL 260 SET TESTER

This VOM features extreme versatility, accuracy and ruggedness. Current measurement is practically negligible. Molded bakelite sub-panel assembly has separate pockets for multimeters, providing maximum strength and added insulation. DC measurement: 20,000 ohms/volt. Reads as low as 2 microamps and 1/2 ohm, and as high as 10 amps and 20 mega. 4 1/2" meter. AC sensitivity, 1000 ohms/volt. Ranges: AC, DC and output volts, 0-2.5-10-50-250-1000; to 5000 volts on AC and DC only. DC current, 0-100 microamps; 0-10-100-500 ma and 0-10 amps; resistance, 0-2000-200,000 ohms and 0-20 megs. Db, -12 to +55 in 5 ranges. Molded bakelite case. 5 1/2" x 3 1/4". With batteries and leads. Shpg. wt. 5 lbs. NET 38.17

No. 1818 Cowhio Case. Carrying case for above. 1 lb. NET 6.61

Model 260B — as above but with "roll to test" feature. NET 45.96

No. 0007W Probe. Extends DC range to 25,000 volts. Wt., 8 oz. NET 9.75

SUPERIOR TV-11 TUBE TESTER

Tests all tubes including 4, 5, 6, 7, octal, lock-in, pentac, pentax, hearing aid, Thyratron, miniature, sub-miniature, novel, sub-minor, proximity fuse type, etc. Will test for "shorts" and "leakages" up to 5 megohms. Uses the new self-cleaning lever action switches for individual element testing. The user can instantly identify which element is under test. Truly tests tubes with tapped filaments as any of the pins may be placed in the neutral position when necessary. Individual sockets for each type of tube. No combination sockets used. Built-in roll chart provides complete data. Line voltage control compensates for variations between 105 and 130 volts. Jack on front panel for plugging in phones or amplifier to detect noise. The TV-11 may also be used as an extremely sensitive condenser leakage checker. Will detect leakage even when the frequency is one per minute. Operates on 105-130 volts, 60 cycles AC. Housed in an oak cabinet complete with cover. 11 1/2" x 13" x 4". Shpg. wt. 15 lbs. SUPERIOR TV-11 NET 46.55

PHAOSTRON 555A VOLT-OHM-MILLIAMMETER

- 43 UNDUPLICATED RANGES!
- METER MOVEMENT PROTECTED UP TO 1000 TIMES OVERLOAD!



This expertly designed multimeter has double magnetic shielding for extreme accuracy. Features a large easy-to-read meter scale on 4 1/2" scale; meter movement protection up to 1000 times overload; separate Range and Function switches; only 2 test lead jacks for simplicity; 3% DC, 4% AC permanent accuracy. Sensitivity: 20,000 ohms per volt DC; 2000 ohms per volt AC; AC current ranges: 0-1.5-5-15-50-150-500-1500 ma. and 0-15 amps; DC current ranges: 0-50-150-500-1500 microamps, 0-1.5-5-15-50-150-500-1500 ma. and 0-15 amps. Resistance: 0-1000-100,000 ohms; 0-1-10 megohms. AC and DC Volts: 0-1.5-5-50-800-1500, 6 db ranges. "Transit" switch position for meter movement protection during transportation. Metal case with die cast bezel. 6 1/2" x 4 1/2" x 2 1/2". Shpg. wt., 5 lbs. MODEL 555A NET 43.61

Genuine Leather Carrying Case for 555A NET 7.79

PHAOSTRON MODEL 666 — Deluxe VOM features overload fusing and signal light, and handsome leather carrying case. 3 1/2" x 8 1/2" x 7 1/2". With probe, power cord and batteries. Shpg. wt., 5 lbs. MODEL 666 NET 58.31

RCA MODEL WV-98A NEW SENIOR VOLTOHMYST



75 00

The new Senior VoltOhmyst features a large, 6 1/2" easy-to-read, wide-vision meter; expanded meter scale with separate peak-to-peak scales; 3% accuracy full-scale on both AC and DC; sturdy, single unit 3-reinforced probe with built-in DC/AC Ohms switch; ruggedized die-cast aluminum case. DC VOLTS — 7 ranges: 0 — 1.5 — 3 — 15 — 50 — 150 — 500 — 1500, 11 megohms input resistance; AC Volts — 14 ranges. Peak-to-peak 0 — 1 — 14 — 42 — 140 — 420 — 1400 — 4200 Volts. RMS (for sine waves) 0 — 1.5 — 5 — 15 — 50 — 150 — 500 — 1500 volts; Ohms: 7 ranges: 0-100 megohms. Frequency response with WG-299A probe set to AC — OHMS: 1.5, 5, 15, 50, 150, 500 volt ranges flat from 30 cps to 3 Mc for voltage source having 100 ohm impedance or lower. 1500 volts maximum — DC and AC input voltage. For 105-125 volts, 50/60 cps. Blue-gray hammertone case with satin-aluminum panel. 6 1/2" x 7" x 3 1/2". Complete with battery, tubes, new DC/AC — Ohms switch probe WG-299A, shielded cable and instruction booklet. Shpg. wt., 7 lbs. MODEL WV-98A NET 75.00

SPRAGUE

MODEL TO-4 TEL-OHMIKE



72 03

Bridge-type instrument for measuring capacitance and resistance. Locates open, intermittent or shorted condensers and resistors. The only instrument of its class that will check small ceramic capacitors used in TV sets. Power factor, 0-55%. Capacitance, 1 mfd to 2000 mfd in 5 ranges. Resistance, 2.5 ohms-25 megs in 3 ranges. Leakage current, 0-6/60 ma. Polarizing voltage: 0-60/120 volts. Insulation resistance: 150-20,000 megohms. For 110-120 v., 60 cps. Size: 8 1/2" x 4 1/2" x 6 1/2". Shpg. wt., 15 lbs. NET 72.03

URANIUM HUNTERS

PROSPECTORS - ENGINEERS - HOBBYISTS

PRECISION RADIATION

108
**GEIGER
COUNTER**

29.95

New, low priced Geiger counter featuring high sensitivity to radio-active substances and extremely compact design. Fits in pocket or palm of hand. Detects uranium ore, cosmic rays, radium and x-rays by instantly producing a loud series of clicks in earphone. The number of clicks increases as counter approaches source of radio-active material. Uses a miniature amplifier tube, one 22½V. hearing aid battery and one flashlight battery. Replacement cost of batteries is nominal. They are easily changed by anyone without use of tools. Geiger tube operates at 300V. and is protected by an automatic safety device which prevents excessive voltage. Strong plastic case 1½x2½. Supplied complete with headset, batteries, radio-active sample and instruction.

Precision Radiation Model 108—

Shpg. wt. 3 lbs.

29.95

New!

EICO

**GEIGER
COUNTER**

KIT
19.95

Simple to use. Rugged, dependable, super-sensitive—at the industry's lowest cost! Excellent for prospecting, industrial, scientific and civil defense work. Finds even poor uranium deposits, detects ore with as little as .01% uranium. .05 milliroentgens hour. Dual simultaneous indications flashing neon panel lamp; and clicks from headphone plugged into panel jacks—you can detect even while you ride your car! All-electronic battery-operated circuit with no moving parts. Super-sensitive 200-volt geiger tube with very thin brass envelope. Tube is more rugged and sensitive, and sensitive along a greater part of its length than corresponding glass tube geiger tubes. Tube life is 100 million to 1 billion counts. Sensitivity is 3000 counts/min./hr. Radioactive test sample supplied. **SPECIFICATIONS:** Tubes—2-1U5; Power Supply—900-volt, induction coil, low-drain type. Potentiometer adjustment of voltage permits operation over entire battery life. Size—7 x 4½ x 2½". Sturdy draw-aluminum case, hammer-look finish.

No. 803K—Less 2-67½v & 2-1½v batteries **19.95**

**PRECISION
RADIATION
GEIGER
COUNTERS**

99.50



Professional type, extremely sensitive unit detects beta particles as low as 160 K.E.V. as well as gamma rays, x-rays and cosmic rays. Has all three ways of indicating radio-activity: neon flasher, earphone and 3-range meter—2, 2 and 20 milliroentgens/hr. full scale. Detects even the faintest traces of uranium. Automatic voltage regulator circuit eliminates need for any adjustments. Rugged, weatherproofed case, 3¼x4½". Uses 2 flashlight cells and 2 small 45V. batteries. Earphone, batteries, carrying belt and tube included.

Model 106—Shpg. wt. 7 lbs.

99.50

Model 107—Same as above plus a directional, stainless steel probe enclosing Geiger tube. Sliding shield around probe used for discriminating between betas and gammas. 3-ft. polystyrene coaxial cable connects probe with case. Side clamps on case support the probe when not in use. Shpg. wt. 8 lbs.

149.50

CALIBRATED RADIUM STANDARD

Kit contains five certified radium standards covering the range from 100 to 1,000,000 disintegrations per minute. Standards are mounted on engraved discs. Each gold-plated standard is individually packed in a clear plastic box—all contained in a hinged case. Permanent standards are used to test and calibrate any counter, scintillator, ionization chamber, Geigerscope or any other detectors. Supplied complete with handling forceps, plastic instrument cap and data sheet giving the certified alpha, beta and gamma activities of the five standards. Shpg. wt. 2 lbs.

MS-119

Net 3.38

ULTRA VIOLET BULBS

Long Wave Ultra Violet Bulb: Powerful 250 watt ultra violet source. Fits ordinary 110 volt socket. The filter is built in—nothing else to buy. Produces fluorescence in many uranium minerals—other minerals—chemicals—oils—plastics—fabrics—etc. Perfect for fluoride bead test. Complete with data sheet on fluorescent materials. Shpg. wt. 8 ozs. **MS-121** Net 1.65

Short Wave Ultra Violet Bulb: Simple source of short wave ultra violet radiation. Produces fluorescence in tungsten ores—carbonates—and other materials which do not react to long wave UV. Produces ozone—deodorizes—sterilizes air. Gives full range of UV. Use with either 110V. or portable battery. Complete with special socket—simple diagram—direction and data sheet. Shpg. wt. 1 lb **MS-122** Net 1.80



BEAD TEST KIT

One of the most sensitive means of detecting and confirming uranium minerals. Distinguish between uranium and thorium. The sodium fluoride bead test is used in conjunction with ultra-violet light. Only the best of materials are used in this kit. The chemically pure sodium fluoride meets American Chemical Soc. specifications. Kit contains enough for hundreds of tests. Purified platinum wire bead holder. Complete kit contains sodium fluoride, bead holder with glass handle, forceps and direction sheet. All in clear plastic case that fits your pocket. Shpg. wt. 1 lb

MS-120

Net 1.67

RADIOACTIVE ORE SPECIMEN KIT

Four rich mine samples from different parts of the country. Packed in a pocket size clear plastic box. Representative samples of all five commercially important radioactive ores. These are real "museum pieces". Help you to become familiar with physical properties of ores. Supplied complete with data sheet giving all the identifying characteristics and important mineralogical properties. Shpg. wt. 2 lbs.

MS-119

Net 1.67

PROFESSIONAL GEIGERSCOPE

Detects Uranium and radio-activity. Designed for the prospector—chemist—civil defense worker—physicist—industrialist. Requires no power source—converts energy of alpha rays into visible signals. Will detect a smaller single crystal of radioactive mineral than a Geiger counter. Detects and measures any alpha-active isotope down to the range of a millionth of a microcurie. Sturdy—durable—portable as a pocket watch. Detects contamination of air—surfaces—hands—apparatus—measures fallout. Complete with radium standard—ore sample—air tight holster and instructions. Shpg. wt. 8 ozs.

MS-113

Net 3.38

STANDARD MODEL

Similar to above, but less radium standard—eye piece—and holster. Includes ore sample and directions. **.98**

MS-114

Net 98c

ATOMIC PROSPECTORS KIT



3.38

A complete set of basic tools for the prospector. Equally useful to the amateur and the professional. Includes a standard model Geigerscope for detecting radioactivity—steel "goldpan" made to professional standards—panning instructions—Atomic Prospectors Handbook—magnifying glass—forceps—streak plate—magnet—uranium ore sample. Plus a bag of placer ore containing uranium, thorium, titanium, zircon, garnet and gold—for familiarizing yourself with the operations. Shpg. wt. 6 lbs. **MS-115** Net 3.38

ATOMIC PROSPECTORS HANDBOOK

Describes methods and apparatus used in field and lab. Detailed—concise—"all meat." Contains charts—maps—and illustrations. Clearly understandable. **MS-116** Net 59c

ULTRA VIOLET FLASHLIGHT



2.39

Brand new, inexpensive, completely portable ultra-violet light. Developed specifically for the uranium prospector.

Special filter lens concentrates the long wave ultra-violet into a powerful beam. Will cause fluorescent uranium minerals to glow at a distance of ten feet or more. Compact, rugged and operates on ordinary flashlight batteries. Will also cause fluorescence in many other minerals and materials. Supplied complete with data sheet listing fluorescent minerals. Less Batteries. Shpg. wt. 2 lbs.

MS-117
BURGESS #2 Cells

Net 2.39
each 10c

Remote Control Equipment & Hobby Items

R/C RECEIVER and TRANSMITTER

AN R/C RECEIVER COMPLETELY ASSEMBLED AND WIRED — INCLUDES TUBE — READY TO OPERATE!

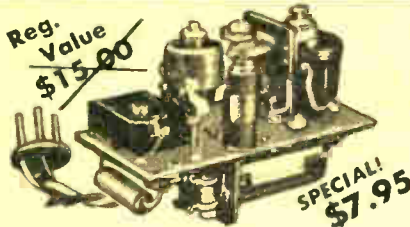

Reg. Value
~~\$15.00~~

SPECIAL!
\$7.95

A truly sensational value in a superbly designed and constructed hard-tube R/C receiver. Operates on popular exam-free 27.255 MC remote control band. Extremely efficient and dependable. This amazing receiver has more than adequate sensitivity for a range of approximately 1 mile. Outstanding for economy of operation, its minimum life with initial 384 tube is several thousand hours! Ingeniously constructed for unmatched stability of performance, and to withstand unusual vibration and shock. Requires one 1.5 volt A battery, one 46 volt B battery and 24" antenna lead. Size: 1 3/4" x 1-15/16" x 3". Weight 3.3 oz.

F-208 Net 7.95

SUPER MINI-MOTORS

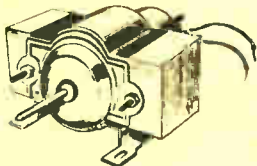

1/30 h.p.—1.5 to 8 V.D.C. operating voltage, 6 V.D.C. Power consumption 200-250 MA. 2,800 to 4,000 RPM oh 6 V.D.C. Weight 5 oz. Overall dimensions: 2 1/4" x 1 3/8" x 1 1/2". Shaft length 2 3/4". Shpg. wt. 8 oz. F-177 Net 1.49

High speed, powerful, battery operated motors. For hobbyists—labs—industry. Instantly reversible. Operate from flashlight batteries. Two pole permanent magnet field. Brass sleeve bearings—phosphor bronze brushes. Industrial design casing and mount. Shaft diameter 3/32". Entirely enclosed—chrome plated.

1/60 h.p.—1.5 to 4.5 V.D.C. operating voltage, 3 V.D.C. Power consumption 250-350 MA. 5,000 to 6,000 RPM at 3 V.D.C. Weight 2 oz. Overall dimension: 1 3/4" x 1 1/4" x 1 1/4". Shaft length, 2". Shpg. wt. 4 oz. F-178 Net 85c

27.255 MC REMOTE CONTROL CRYSTAL



27.255 MC crystal used in remote radio control of hobby airplanes, boats, etc. Frequency lies within "citizen band"

Low drift, high output, dependable frequency control. Tolerance .04%, 0.720" wide x 0.309" deep x 0.758" high above pins; 1/2" between pins. MS-296 Net 2.95



27.255 MC CRYSTAL SOCKET

Ceramic, low loss socket for 27.255 MC crystals. Small — light — rugged. MS-297 Net 15c

15c

5 DIGIT COUNTER



• INDUSTRIAL TYPE
• 0-99999

Ruggedly made—small—accurate 0-99999 counter. Has flange drilled—ready to mount. Resets to '0' by turn of reset knob on side. Case is black crackle finished. Complete with spring and actuating arm. Shpg. wt. 1/2 lb. F-190 Net 4.35

R/C TRANSMITTER COMPLETELY ASSEMBLED — TESTED — AND GUARANTEED!

• First Time at this Price! • Not a Kit — Fully Wired — Includes Tube and 27.255 Mc Crystal • No License Examination Required • Range 1 Mile and More!

Footproof, factory assembled and tested transmitter. Weighs only a scant 4 1/2 lbs. with batteries. Uses powerful 3A5 tube for all the range you need. Antenna is 4 ft. 6 in. long — six sections telescope down to 10 inches. Novel "plug-in" feature permits simple removal and replacement of antenna. Overall dimensions are 4" x 4" x 12", exclusive of antenna. Will operate any R/C receiver of 27.255 MC. Power output affords unusual range of control. Less batteries. Shpg. wt., 3 lbs. F-249 Net 19.95

Batteries for F-249 Transmitter
1—Burgess 2D or RCA VSO69 Net, Each 45
2—Burgess XX45 or RCA VSO16 Net, Each 2.28

SPECIAL COMBINATION OFFER

Consists of R/C Transmitter (F-249), R/C Receiver (F-208) and Escapement (F-194). All Three at super special price! F-250 Net 28.95

R/C MANUALS

#43 Model Control by Radio 1.00
#53 Radio Control Handbook 2.25

REMOTE CONTROL ESCAPEMENT

• At the lowest price anywhere!
• Weighs less than 1/2 oz.!

A fine, sturdy self-neutralizing escapement. Completely wired (not a kit). Converts electrical impulses from remote control receiver to mechanical motion for varying movement of plane, boat, or car. Very low current drain. Size: 1 1/4" L x 1 1/2" W. Shpg. Wt. 5 oz. F-194 Net 2.45

2.45



19.95

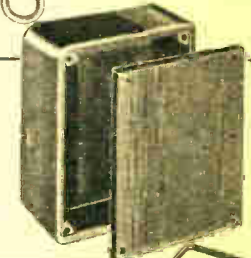
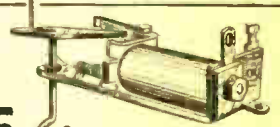

BAKELITE METER CASES

SMALL CASE

Ideal for building test equipment and small electronic devices. Overall size 6 1/4" x 3 3/4" x 2" D. Walls 1/2" thick. Rounded corners have recessed threaded inserts for mounting panel.

MS-216 in lots of 3, each 59c
Singly, each 65c
MS-217 Panel for above 39c

HANDY LANTERN

• HAND — BICYCLE — CAMPING LANTERN!
• COMPLETELY CHROME PLATED!

Hottest lantern we've ever seen! Heavy chrome jewelers finish. Universal bracket for mounting on any bike — or carry it by self contained handle. Measures only 3 1/2" x 3 1/2" x 2 1/4" overall. 3 1/4" chrome visored, highly polished reflector for strong beam. Uses 2 "D" cells. Complete with spare bulb and universal bracket. Less batteries. Shpg. wt., 1 1/2 lbs. F-251

1.89

Batteries for above — Burgess #2 or RCA VSO36 Net, Each 10c

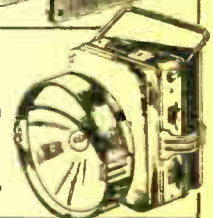

27.255 MC REMOTE CONTROL CRYSTAL

27.255 MC crystal used in remote radio control of hobby airplanes, boats, etc. Frequency lies within "citizen band"

Low drift, high output, dependable frequency control. Tolerance .04%, 0.720" wide x 0.309" deep x 0.758" high above pins; 1/2" between pins. MS-296 Net 2.95

27.255 MC CRYSTAL SOCKET

Ceramic, low loss socket for 27.255 MC crystals. Small — light — rugged. MS-297 Net 15c

15c

5 DIGIT COUNTER



• INDUSTRIAL TYPE
• 0-99999

Ruggedly made—small—accurate 0-99999 counter. Has flange drilled—ready to mount. Resets to '0' by turn of reset knob on side. Case is black crackle finished. Complete with spring and actuating arm. Shpg. wt. 1/2 lb. F-190 Net 4.35

"MIGHTY MIDGET" MOTOR

• POWER AT YOUR FINGERTIPS!
• RECOMMENDED FOR INDUSTRIAL AND LABORATORY USE!

A midget motor precision built to engineering standards. Normal current consumption less than a flashlight bulb. Armature speed to 6000 RPM — counter shaft speed of 650 to 1000 RPM. Measures 1 1/4" x 1-11/16" x 1-3/16". Replaceable brushes—brass screw terminals. Operates on 3 to 6 volts D.C. Instantly reversible. Supplied complete with 7 to 1 reduction gears — pulley etc. Shpg. wt., 6 oz. F-253 Net 2.95



MICRO MOTORS

• SPECIALLY DESIGNED FOR SERVO AND INSTRUMENT USE
• APPROVED BY THE BRITISH MINISTRY OF SUPPLY

Designed specifically for industrial applications. Self starting and reversible. Low current consumption. Only 2200 MA at 6 volts — no load, speed 7000 RPM. Totally enclosed. Fitted with self oiling phosphor bronze bearings. Replaceable carbon brushes. Weighs 1.3 ozs. Overall length 2.03" — shaft length .469", diam. 2 mm. Body diameter 1". Highly recommended for industrial and laboratory development work. Shpg. wt., 6 ozs. F-254 Net 5.95

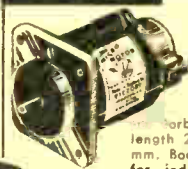

TIMERS for HOME OFFICE & INDUSTRY

INTERMATIC TIME-ALL

• THE AUTOMATIC TIMER WITH THE MIRACLE MEMORY

7.97

Makes practically everything electrical completely automatic. Will handle load up to 1650 watts. Turns radio on and off—does not have to be reset each night. Defrosts refrigerator—turns lights on and off—controls roaster, electric blanket, air conditioner, washing machine, coffee makers, vaporizers, etc. 30 min. minimum on time—23 hours maximum. As easy to set as an electric clock. Stands on any surface—can be hung on wall. Easy-to-read 24 hour "day and night" dial. Operates day after day without attention. Can be controlled manually without automatic reset. Plug in receptacle for equipment to be controlled. For 110 volt 60 cycle AC only. Complete with 6 ft. cord and plug. Instructions included. 5"x4"x2 1/2". Shpg. Wt. 2 lbs.



MS-81

Net 7.97

INTERMATIC CLOCK TIMER

9.67

Not only tells time, but turns appliances both on and off automatically for periods of 15 minutes to 5 1/2 hours. Cooks dinner while you're away, wakes you to music, controls electric fans, heaters, radios, TV sets, etc. No installation problem—just plug it in and set. Capacity 1650 watts. Plaston case 4 3/4" W x 4 1/2" H x 2 1/4" D. 6 ft. cord. For 110V 60 cycle AC. Guaranteed for 1 year. Shpg. Wt. 3 lbs. Price includes excise tax



MS-104

Net 9.67

TIME SWITCHES FOR WALL BOX INSTALLATION

5.21

A dependable and versatile time switch to automatically turn off attic fans, porch and garage lights, window lights, heating units, etc. at any preset time. Has special HOLD feature: turn of a knob cuts out timing mechanism and allows unit to be used as a regular toggle switch. Capacity 20 amps, 125 volts AC. Satin-chrome dial 4 1/2" H x 3" W; switch 2 1/2" H x 1 3/4" W x 1 1/4" D. Fits any standard rectangular wall box. Shpg. wt. 3 lbs.



MS-135—Time range up to 1 hour. Net 4.46

MS-136—Time range up to 12 hours. Net 5.21

INTERMATIC 5 TO 60 MINUTE TIMER

- UP TO 14 COMPLETE "ON-OFF" CYCLES.
- EACH CYCLE INDIVIDUALLY ADJUSTABLE FOR 5 TO 60 MINUTE OPERATION.
- 4000 WATT CAPACITY.

Here is an unusually versatile timer that has distinguished itself in the home, on the farm and in industry, in applications where multiple "on-off" cycles of 5 to 60 minutes are required within a 24 hr. period. A minute selector is provided on each specially designed tripper for setting the number of minutes. (5 to 60), the "on-off" cycle will operate. Up to 14 trippers can be placed on the same dial at the same time. Minimum interval between starts of each cycle, 1 3/4 hrs. Large, silver, snap-action contacts rated 35 amps, 125 volts, AC. High-torque slow-speed dependable synchronous timing motor. Gray steel case 7 7/8" x 5" x 3". Supplied with 3 trippers (for 3 "on-off" cycles). For 110-125 volts, 60 cycle, AC. Shpg. wt. 4 lbs. NET \$11.02



Extra Trippers for above. One tripper for each additional "on-off" cycle. Wt. 4 ozs.

MS-142

MS-144

NET .49¢

INTERMATIC POULTRY TIMER

- MORE LIGHT, MORE EGGS, MORE PROFIT, HEALTHY HENS!

Prolongs daylight in winter and fall. Gives you additional eggs when egg prices are highest. Designed for morning and evening lighting or evening lighting alone. Provides automatic 20-minute "Dimming" period after bright lights go "off" enabling hens to reach roost safely. Controls one circuit for bright lights, another circuit for dim lights. Capacity: "Bright" 3000 watts (24 amperes at 125 volts), "Dim" 1000 watts (8 amperes at 125 volts). Gray steel case 7 7/8" x 5" x 3". For 110 to 125 volts, 60 cycle, AC. Shpg. wt. 4 lbs.



MS-145

NET \$7.77

4 BUTTON ALARM TIMER SWITCH

- SLEEP SWITCH
- BUZZ ALARM
- AUTOMATICALLY TURNS ON RADIOS, ETC.

We've done it again. We bought up the overstock of an equipment manufacturer to bring you this automatic 4-button timer at a giveaway price. Turns on radios, TV sets, toasters, etc. at any preset time within 12 hour period. Built-in SPST switch handles up to 15 amp 115 volts. Has sleep switch so you can go to sleep to music—it will automatically shut off radio at preset time up to 90 minutes. And it also falls time. For 110-120V 60 cycle. Shpg. Wt. 1 1/2 lbs.



5.70

MS-105

Net 5.70



INDUSTRIAL TIMER SWITCH

• 4000 WATT CAPACITY

Turns equipment "on" and "off" once in 24 hours, or from one to twelve "on" and "off" operations a day can be obtained by use of extra trippers. Extra trippers can be added without removing dial. Min. on or off time 1 hr.—max. on or off time 23 hours. Can be turned on or off manually with reset SPST switch rated at 35 amps. Has convenient mounting holes and knockouts. Large numbers—easy to read—easy to set. Gray steel case with knockouts—hinged door—can be locked or sealed. UL approved. Operates on 110 volt 60 cycle AC only. Size 7 3/4" L x 5" W x 3" D. Shpg. Wt. 4 lbs.

MS-112

Net 7.12

7.12

INTERMATIC "SKIPPER" TIME SWITCHES

• SKIPS OPERATIONS ON SELECTED DAYS

• 4000 WATT CAPACITY

An ingenious time switch that not only automatically turns equipment on or off, but will skip operations on any selected days. Ideal where offices or factories are closed on Saturdays, Sundays or Holidays. Turns "on" and "off" once every 24 hours with single set of trippers supplied, but up to 11 on and off operations can be had by adding extra trippers listed below. Supplied with 3 skipping screws; more can be added. Also has 1 cutout tripper which advances day dial automatically. Snap action contacts rated at 35 amps at 125 volts. Min. on or off time 1 hour, maximum 23 hours. Size 7 3/4" x 5" x 3".



11.02

Shpg. wt. 4 lbs. For 110-120V, 60 cycle AC operation.

MS-130 — type TS64SP—S. P. S. T.—Skips "ON" Operation

Net 11.02

MS-146 TYPE TS 64SPDT—Single Pole Double Throw. Opens one circuit and closes another. Single either "ON" or "OFF" operation. NET 12.32

ACCESSORIES

EXTRA TRIPPERS—Set of on-off trippers to add more operations. MS-93—per set. Net .29

SKIPPING SCREWS—For "Skipper" types only. MS-133. Net .03

CUT-OUT TRIPPER—For "Skipper" types only. MS-134. Net .20

PORTABLE TWO SPEED PRECISION TIMER

• TWO TIMERS FOR THE PRICE OF ONE!

• FOR PRECISE 1 SECOND TO 1 HOUR TIMING IN THE HOME, OFFICE AND LABORATORY

Indispensable for timing precise, short operations such as balling eggs, pressure cooking, heat and sun lamp treatment, home permanents, photo developing and printing, long distance calls, etc. Times up to 6 minutes in seconds and up to 1 hour in minutes. Exclusive 2-speed feature—permits instant timing speed change by flick of a lever. A clear, resonant bell sounds at end of timing period. Can be attached to any surface with handy wall bracket supplied or can stand upright. Smartly styled in white with dial face of rich copper tone, 4" x 2 1/2". Shpg. wt., 2 lbs. MS-294. Net 4.68



MS-294

UTILITY HOUSEHOLD TIMER

• DEPENDABLE 1 MINUTE TO 1 HOUR TIMING

This reliable, low-priced timer in a neat durable white plastic case has innumerable household timing uses, i.e., cooking, baking, home permanents, games, remembering appointments, TV and radio programs, etc. Attractive, modern design. Times any interval up to one hour accurately and gives resonant bell signal at end of period. Large easy to set and easy to read dial. 3 1/2" x 3" x 1 1/2". Shpg. wt., 1 1/4 lbs.



MS-295

NET 2.95

FAMOUS MAKE TIMER SWITCH

BELOW JOBBER COST!

Another Lafayette Scoop! A radio manufacturer, making clock radios, overpurchased on electric clocks—needed the cash—liked our greenbacks, and Lafayette got the deal. Automatically turns on radios, television sets, toasters, coffeemakers, etc.—at any pre-set time within 12 hour period; also tells time. Built-in single-pole switch handles up to 15 amps, 115 volt. Requires 3/2" diameter round hole. Depth behind dial face 2 1/4".

\$3.95

Stock No. MS-62

UL approved. For 105-125V, 60 cycle AC. Shpg. Wt. 1 1/2 lbs.

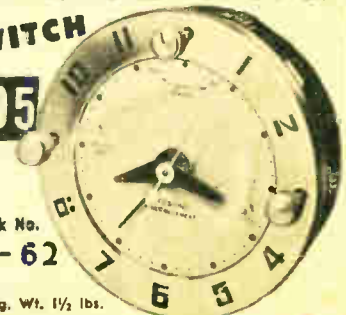

Speaker at The Finest Quality UNBEATABLE GUARANTEED PRICES!

OVAL PM SPEAKERS

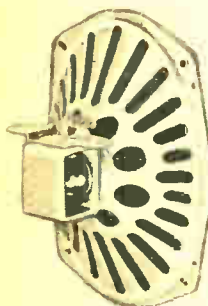

These oval speakers are extremely popular, and Lafayette has made them even more popular by offering them to you at the lowest prices consistent with high quality Alnico V magnet 32 ohm voice coil. At these prices you can afford to order some for stock.

4" x 6" \$1.99 in lots of 3
Stock No. SK-16 single, ea. 2.09

5" x 7" \$2.15 in lots of 3
Stock No. SK-32—singly, ea. 2.39

6" x 9" \$2.99 in lots of 3
Stock No. SK-17 single, ea. 3.15

REAR SEAT AUTO SPEAKER KIT



DeLUXE 6" x 9" KIT WITH 2.15 OZ. ALNICO V MAGNET

A complete kit for adding another speaker in the rear of your car. You get a 6" x 9" PM speaker with a 2.15 oz. Alnico V magnet (the same heavy duty type you find in kits selling for twice this price), a CRL PK300 three position switch so you can select either speaker alone or both together, dial plate with mounting bracket, knob and hardware, a chrome grille, wire and wiring instructions. Simple to install. Shpg. Wt. 5 lbs. SK37 **NET 4.75**

DeLUXE 5" x 7" KIT

Contains same accessories as above kit — except uses 5" x 7" speaker and chrome grille. Shpg. wt., 3 lbs. SK-42 **Net 4.32**

FADER TYPE AUTO KITS

Rear seat auto speaker kits, identical to the above but with fader type control, which gradually increases volume on one speaker while diminishing other. Shipping weight 5 lbs.

SK-55—5x7 kit 4.60
SK-56—6x9 kit 4.95

Auto Replacement Speaker



An unusual value in 5 field coil speakers. Ideal for auto replacements for Philco, Motorola, Automatic and other auto sets. 4 ohm 6 volt.

5 SPEAKER in lots of 3

Stock No. SK-21 single, ea. 89¢

79c

T.V. SPEAKER EXTENSION



Has 3 way switch so you can listen to T.V. set speaker alone, the extension speaker alone, or both. Volume control on extension speaker so you can control loudness at your chair. Complete with 20 ft. cable. Simple instructions for attaching. Shpg. Wt. 4 lbs. SK-32 **Net 7.61**

UNIVERSAL REAR SEAT SPEAKER



Designed for use with latest models as well as older cars. Four inch Alnico V PM speaker completely enclosed in a plastic case. Aluminum voice coil for high wattage capacity and resistance to moisture. Built-in volume control and off position for rear seat passenger control. Ample wire and hardware included. SK-29.....**NET 4.26**

CHROME Speaker Grille

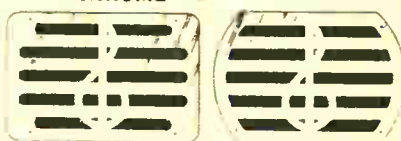

Deluxe chrome speaker grille in a handsome modern motif. Perfect for rear seat installation — recreation room — intercom or P.A. — test panel and equipment. Complete with flocked screen and mounting hardware.

Stock No. ML-17, 4" x 6" installation **1.00**
Stock No. ML-69, 5x7 installation **1.15**
Stock No. ML-16, 6" x 9" installation **1.35**
STOCK NO. ML-38, 8" installation..... **1.50**

CRL 54c AUTO RADIO SPEAKER SWITCH

Type 1483 SP 3 position switch for use with dual rear seat auto radio speakers. Rated 3 amp at 6 volts. Has positive index starting contacts. 3/8" bushing, 1 1/2" long shaft. Spring brass contacts, silver plated. Wt. 1 oz. NET **.54**

59c AUTO RADIO SWITCH KIT

Switch Kit. For use with dual auto speakers. Consists of 3 position switch with 3/8" bushing and 7/16" knurled shaft, indicator plate and white position knob. Wt. 2 oz. MS-266 **.59**

DUAL SPEAKER CONTROL KIT



Designed to vary the volume either front or rear speaker — or both. Adds position switch to rear seat speaker installations. Control allows desirable amount of audio from one speaker while maximum audio is received from other, giving a dimensional effect. Includes wire around control — knob — mounting plate — and simple instructions. MS-187 **Net .83**



FABRICOID Baffles

Sturdily built of selected wood. Brown leatherette covered. Shpg. wt. 6 lbs.

Stock No.	Speaker	M. W. D.	Each
SB-14	6"	8 1/2 x 7 1/2 x 4 1/2"	1.89
SB-15	8"	10 1/2 x 9 1/2 x 5 1/2"	2.85
SB-16	10"	14 x 12 1/2 x 7 1/2"	3.15
SB-17	12"	15 1/2 x 14 x 10"	3.65

WALSCO ORNAMENTAL GRILLE

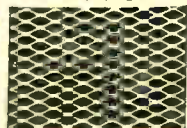

Heavy perforated grille, beautifully "brushed brass" plated and lacquered with gold finish effect. For use over cloth or screening in custom built radios, P.A. Speakers and juke boxes. ML-22—5x7 12" x 18" **1.76**
ML-23—5x7 18" x 24" **3.23**

FLOCKED GRILLE SCREENING

Protective grille for radio, intercom, etc. Won't tear, fray. ML-25—8x11", Brown **56¢**
ML-26—18x24", Brown **1.88**

SPEAKER SHIMS

Non-magnetic Manel shims. 4 each .001", .002", .003", .004", .005", .006", .007", .008", .010" shims. In plastic case with pencil clip. MS-27— **39¢** Each

WALNUT WALL Baffles

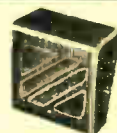

Beautifully polished walnut baffle for Deluxe sound systems. Frieze grille cloth.

SB-10 6 inch	2.79
in lots of 12 each	2.25
SB-11 8 inch	3.23
in lots of 8 each	2.75
SB-13 10" and 12"	4.69
in lots of 4 each	4.10

SPEAKER GRILLE CLOTH



New modern designs and patterns. Replace old grille cloth — patterns fit design of any cabinet. Light or dark shades available. Match walnut-mahogany or blonde.

SB-37 12" x 12"	Net .41
SB-38 24" x 13"	Net .79
SB-39 36" x 36"	Net 3.70

THE GREATEST BARGAINS

Why Pay More for TRANSFORMERS

Lafayette Top Quality TRANSFORMERS

UNIVERSAL OUTPUT



Here is a real bargain in a top make universal output transformer. Will match any single or push-pull output tube. Be ready for any service job by ordering some of each

4 Watt
No. TR-12, ea. 99c,
in lots of 10, 90c ea.

8 Watt
No. TR-13, ea. 1.09,
in lots of 10, \$1.02 ea.

FILAMENT



Top Make
at a Real Price
115V Primary
6.3V at 1 amp.

No. TR-11 \$1.19 **\$1.09**
in lots of 10, ea.



50L6 OUTPUT

Matches 50L6 to 3.2 Ohm Voice Coil
Made by a high quality transformer manufacturer. Matches 50L6, 35L6, 25L6, etc. Lafayette bought a large quantity of a special price and we are passing the saving on to you. You can't go wrong at this price.

Stock No. TR-10,
singly, ea. 59c
Lots of 5 **49c** ea.



SELENIUM BATTERY ELIMINATOR

Converts your battery operated portable for operation on 110 V, 60 cycle AC. Simply plug eliminator into AC outlet and plug your set into proper socket of eliminator. Delivers 1.5 volt "A" and 90 volt "B". Filtered, hum-free reception. Uses no tube. Size 2 1/2" x 4 1/2" x 6 3/4". Shpg. Wt. 5 lbs

Stock No. ML-30, 11.14

VIBRATOR TRANSFORMERS

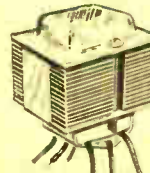

1.49 ea.
in lots of 3
1.59 Ea.

Best quality vibrator transformers at a fraction of their value. 6 leads, tapped primary and secondary. Size 2 1/2" x 1 7/8" x 1 3/4" above chassis. Two screw mt. on 1 1/2" centers. Overall depth 2 1/4".

For 6 Volt Cars

Delivers 200 V DC @ 55 mls.
TR-77 - Net Each 1.59
in lots of 3, Each 1.49

For 12 Volt Cars

Identical to above but 12V primary
TR-78 - Net Each 1.59
in lots of 3, Each 1.49

Lafayette just made a deal with one of the TOP BRAND MANUFACTURERS of transformers in the country to supply us with their regular line of transformers under our own trade mark "Lafayette" at a TREMENDOUS SAVING. Lafayette is PASSING THIS SAVING ON TO YOU. You can now buy your transformer requirements with GUARANTEED TOP QUALITY at a saving from 25% to 50% below the regular prices. Don't pass it up! Individually boxed, with diagram and instructions.



REPLACEMENT POWER TRANSFORMERS

A high-quality line of power transformers for replacement or construction use, offering top quality at low prices. Fully shielded, heavy-duty 50° flexible coded leads. All plates and P.I. 1 windings center tapped. 110-120 V, 50-60 cycle primaries

FOR 6.3 VOLT TUBES

Stock No.	NET EACH	No. of Tubes	Plate Volts	Rect. Ma	Rect. A	Fil. 1 V	Fil. 2 V	Mtg. Centers	Wt. Lbs.
100-01	3.10	4	480	40	5	2.3	2	2 x 2-1/2"	3
100-02	3.19	5-6	650	40	5	2.3	2	2 x 2-1/2"	3
100-03	3.69	6-7	650	70	5	3	3.5	2 x 2-1/2"	6
100-04	3.95	8-10	700	90	5	3	3.5	2 1/2 x 2-19/16"	8 1/2
100-05	4.95	10-11	700	120	5	3	4	2 1/2 x 3-1/8"	7
100-06	6.10	12-15	750	150	5	3	3.5	2 1/2 x 3-1/8"	7 1/4
100-07	6.80	12-15	800	200	5	3	3.5	3 x 3-8/16"	10



STANDARD OUTPUTS

For coupling plate or plate of the output stage to the speaker voice coil.
Designed especially for class A amplifiers.

Stock No.	NET EACH	Primary Imp.	Ma	Sec. Imp.	Audio Watts	Size	Mtg. Ctrs.	Wt. Lbs.
103-01	.75	5,000	40	3-2	3	1-3/16 x 7/16 x 7/8"	1 1/2"	1/2
103-02	.75	2,500	50	3-2	3	1-3/16 x 7/16 x 7/8"	1 1/2"	1/2
103-03	.75	9,000	20	3-5	3	1-3/16 x 11/16 x 1 1/8"	1 1/2"	1/2
103-04	.85	2,000	50	3-4	3	1-5/16 x 2-3/8 x 1-1/16"	2"	1/2
103-05	.89	5,000	40	4	5	1-5/16 x 2-3/8 x 1-1/16"	2"	1/2
103-06	1.12	25,000	10	3.5	5	1-5/16 x 2-3/8 x 1-1/16"	2"	1/2
103-07	.89	7,000	30	3-4	5	1-5/16 x 2-3/8 x 1-1/16"	2"	1/2

CENTER-TAPPED FILAMENT TRANSFORMERS

No.	NET	Volts	Amps	Size	Ctrs.	Lbs.
106-01	1.40	6.3	1	1 1/2 x 2-1/8 x 1 1/2"	3-7/8"	1 1/4
106-02	2.12	6.3	3	2 x 2-1/4 x 1 1/2"	2-1/8"	1 1/4
106-03	2.49	5	6	2 1/2 x 3-1/8 x 1 1/2"	3-1/8"	2 1/4



UNIVERSAL OUTPUTS

Matches single or push-pull tubes to speaker voice coil. CT primary. 6 taps on sec. Universal line (500-3000 ohms) to 3", 8", 16 ohm voice coil

No.	NET	Impedances	Watts	Size	Ctrs.	Lbs.
101-01	1.29	Pr. 4000	4	1 1/2 x 2-3/8 x 1 1/2"	3"	1
101-02	1.42	14,000 ohms	8	1 1/2 x 2-3/8 x 1 1/2"	2 1/2"	1
101-03	1.89	Sec. VC	18	2 1/2 x 2-7/8 x 1 1/2"	2 1/2"	1 1/4

FILTER CHOKES

No.	NET	Hys.	Ma	Ohms	Size	Ctrs.	Lbs.
105-01	.95	5.5	50	330	1-5/8 x 1-1/2 x 3/8"	2 1/2"	1/2
105-02	1.06	8.5	50	490	1-5/8 x 1-1/2 x 1/2"	2-3/8"	1
105-03	1.19	16	50	350	2 x 2-1/4 x 3/8"	2-3/8 x 1 1/2"	1 1/2
105-04	1.55	15	75	400	2-1/4 x 2-1/4 x 1/2"	3-1/8"	2
105-05	2.08	10.5	110	220	2-3/8 x 1-1/2 x 3/8"	2-3/8 x 1 1/2"	2 1/2

AUDIO TRANSFORMERS

No.	NET	Description	Ctrs.	Lbs.
104-01	1.79	Sgl. or dbl. button carbon mike to grid	2 1/2"	1
104-02	1.30	1-3 step-up. Single plate to single grid	3"	1

230 TO 115 VOLT AUTOTRANSFORMERS

A well-built, husky stepdown auto transformer. Reduction of 230 250 volts, 50-60 cycles AC down to 110 125 volts. Designed especially for operating radios, amplifiers, various service and test equipment, etc. Shielded construction. Smooth black enamel finish. 4 hole corner mounting. With N front cord and plug. Female receptacle on side of case.

No.	NET	Watts	Size	Mtg. Ctrs.	Lbs.
107-01	4.75	80	3 1/2 x 2-1/8 x 1 1/2"	2 1/2 x 1 1/2"	4
107-02	6.58	150	3 3/8 x 2-3/8 x 1 1/2"	2 3/4 x 2 1/2"	8
107-03	8.65	250	4 1/8 x 3-1/8 x 1 1/2"	3 x 3"	9 1/4
107-04	10.75	500	4 3/8 x 3-1/8 x 1 1/2"	3 x 3 1/2"	11

STANCOR POWER TRANSFORMERS

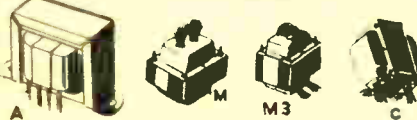

POWER TRANSFORMERS ALL PRIMARIES FOR 117 V., 60 CYCLE A. C.

GENERAL REPLACEMENT

All primaries 117 V. 60 cycle. All secondaries CT, except PS-8415 - has extra 6.3 V. CT. 3 AMP winding * for use with selenium rectifier or 6A55, 6X4 or 6X5. All type M, except EC is Card PS 12 A

POWER TRANSFORMERS

Stan. No.	Plate Vol	Rect. Ma	Rect. A	Fil. A	Fil. Size	Wt. Lbs.	Net Each
PS-8415	125	15	6	3	2 1/2 x 1 1/2 x 2 1/2"	1 1/2	1.85
PS-8416	250	25	6	3	10	2	2.32
PM-8401	470	40	5	2	2 1/2 x 3-1/2"	2 1/2	3.97
PC-8401	470	40	5	2	3 x 3 1/2 x 2 1/2"	2 1/2	3.97
PM-8402	480	35	7	6	2 1/2 x 2 1/2"	2 1/2	4.41
PC-8402	480	35	7	6	3 x 1 1/2 x 2 1/2"	2 1/2	4.41
PM-8419	480	70	6	3	2 1/2 x 2 1/2"	2 1/2	4.41
PC-8419	480	70	6	3	3 x 1 1/2 x 2 1/2"	2 1/2	4.41
PM-8403	500	70	5	2	3 1/2 x 2 1/2"	3 1/2	4.94
PC-8403	500	70	5	2	3 x 1 1/2 x 2 1/2"	3 1/2	4.94
PM-8404	520	90	5	2	3 x 1 1/2 x 2 1/2"	4	5.56
PC-8404	520	90	5	2	3 x 1 1/2 x 2 1/2"	4	5.56
PM-8405	540	120	5	3	3 1/2 x 3 1/2 x 2 1/2"	4 1/2	6.14
PC-8405	540	120	5	3	3 1/2 x 3 1/2 x 2 1/2"	4 1/2	6.14
PM-8406	630	40	5	2	2 1/2 x 3-1/2"	2 1/2	4.06
PC-8407	630	35	5	2	3 x 1 1/2 x 2 1/2"	3 1/2	4.47
PC-8408	630	40	5	2	3 x 1 1/2 x 2 1/2"	3 1/2	4.47
PC-8409	680	70	5	2	3 1/2 x 3 1/2"	4	5.06
PM-8408	680	70	5	2	3 1/2 x 3 1/2"	4	5.06
PM-8409	700	90	5	2	3 x 3 1/2 x 2 1/2"	4 1/2	5.64
PC-8409	700	90	5	2	3 x 3 1/2 x 2 1/2"	4 1/2	5.64
PM-8410	720	120	5	3	3 1/2 x 3 1/2 x 2 1/2"	5 1/2	6.23
PC-8410	720	120	5	3	3 1/2 x 3 1/2 x 2 1/2"	5 1/2	6.23
PM-8411	750	150	5	3	3 1/2 x 3 1/2 x 2 1/2"	5 1/2	7.47
PC-8411	750	150	5	3	4 1/2 x 1 1/2 x 2 1/2"	5 1/2	7.47
PM-8412	800	200	5	3	3 1/2 x 3 1/2 x 2 1/2"	6 1/2	8.41
PC-8412	800	200	5	3	4 x 4 x 2 1/2"	8 1/4	8.41
PC-8414	1200	200	5	3	4 1/2 x 4 1/2 x 2 1/2"	8 1/2	10.61

TV POWER TRANSFORMERS

All primaries 117V 60 cycle. All plate voltages CT, except * for use in voltage doubler circuits. All type M except * is C. * is M 3 is C with 2 sockets. Δ Dual & J windings may be used at 110 V. CT

Stan. No.	Plate Vol	Rect. Ma	Rect. A	Other Filts	Amp.	Size	Wt. Lbs.	Net Each		
P-5059*	675	270	5	CT	3	6.3 CT	5	4 1/2 x 3 1/2 x 4 1/2"	0.6	9.94
P-6115	740	275	5	CT	3	6.3 CT	7	4 1/2 x 3 1/2 x 4 1/2"	0.9	11.47
P-8158	750	205	5	3	0.6	3	2.0	4 1/2 x 4 1/2 x 4 1/2"	9.1	10.88
P-1155	440	90	5	2	6.3	3	5.15	3 1/2 x 2 1/2 x 1 1/2"	4.5	6.53
P-8156	730	295	5	6	0.12	CT	2.0	6 1/2 x 3 1/2 x 1 1/2"	16.5	17.14
P-8157	720	195	5	3	6.3	5.0	7.65	4 1/2 x 3 1/2 x 4 1/2"	11.1	14.70
P-8158	470	105	5	3	6.3	6.3	4.25	4 x 2 x 2 1/2"	6.2	9.32
P-8159	720	250	5	3	0.6	3	2.0	5 1/2 x 3 1/2 x 1 1/2"	10.0	13.82
P-8160	720	185	5	3	6.45	12.0	4	4 1/2 x 3 1/2 x 4 1/2"	9.6	11.91
P-8161	440	70	5	3	6.3	9.0	5.9	5 1/2 x 3 1/2 x 1 1/2"	11.8	15.79
P-8162	760	100	5	CT	3	6.3	9.0	5 1/2 x 4 1/2 x 1 1/2"	9.0	11.32
P-8163	740	190	5	3	6.3	7.75	7.2	5 1/2 x 3 1/2 x 1 1/2"	10.8	14.17
P-8164	600	225	5	3	6.3	9.0	4	4 1/2 x 3 1/2 x 4 1/2"	7.5	11.82
P-8165	700	180	5	3	6.3	2.0	10.0	4 1/2 x 3 1/2 x 4 1/2"	11.1	16.82
P-8166*	680	330	5	6	6.3	3.75	2.5	6.3 x 3 1/2 x 1 1/2"	13.0	17.38
P-8167	500	400	5	6	6.3	4.5	5.0	6.3 x 3 1/2 x 1 1/2"	13.0	16.76
P-8168*	440	330	5	3	6.6	6.5	6.5	4 1/2 x 3 1/2 x 4 1/2"	10.5	15.67
P-8169*	260	220	5	3	6.3	6.3	1.2	5.0 x 2 1/2 x 1 1/2"	10.5	13.91
P-8170*	760	220	5	3	6.3	6.3	2.0	6.3 x 3 1/2 x 1 1/2"	10.5	13.52
P-8171*	600	325	5	6	6.3	2.0	5.0	4 1/2 x 3 1/2 x 4 1/2"	10.0	13.88
P-8331	620	240	5	3	6.3	6.3	6.4	4 1/2 x 3 1/2 x 4 1/2"	9.7	11.07
P-8										

THORDARSON TELEVISION REPLACEMENT COMPONENTS



DEFLECTION YOKES

All yokes have deflection and networks installed, are cosine wound for anti-stigmatic focusing, and have 3 1/8" diameter. Shpg. wt., 1 lb.

THORD. NO.	IND. MM	RES.	HORIZ. VERT.	RESISTANCE HORIZ. VERT.	MAX. SCAN	NET EACH
Y-1	8.3	50	15	68	80"	5.00
Y-2	8	48	15	68	80"	5.29
Y-3	8.3	50	15.5	64.6	83"	5.00
Y-4	13.3	41	23.5	48	70"	5.88
Y-5	8.4	55	11.5	70	70"	5.88
Y-6	10.8	36	13.5	48.7	70"	5.88
Y-7	13.3	41	23.5	48	70"	5.88
Y-8	30	48	45	83	70"	5.29
Y-9	17	44	20	60	70"	5.88
Y-10	20	40	24	60	70"	5.88
Y-11	25	3.3	27	4	70"	5.88
Y-12	30	45	45	60	70"	5.88
Y-13	30	3.5	45	3.5	70"	5.88
Y-14	12	41	14	44	90"	6.47
Y-15	30	42	50	44	90"	6.47
Y-16	19	43	30	50	90"	6.47
Y-17	30	3.5	46	3.5	70"	6.47
Y-18	30	45	45	60	70"	6.76
Y-19	14	38	20	60	70"	6.47
Y-20	20	38	32	50	90"	7.35
Y-21	12	44	15	45	90"	7.64

FILTER CHOKES

All chokes are BAH mounting type except * ones which are mounting type GGV.

THORD. NO.	HYS.	MA	OHMS	SIZE	LBS.	NET EACH
20C49	5	150	58	2 1/2 x 2 1/2 x 4	2.5	2.65
	4.3	200				
	4	230				
20C53	17	60	375	2 x 2 1/2 x 3 1/4	1.5	2.06
	12	80				
	8	100				
20C54*	8	150	145	3 1/2 x 2 1/2 x 3 1/2	3.0	3.82
	8	150				
	4	200				
20C55*	9	150	75	3 1/2 x 2 1/2 x 3 1/4	3.5	4.70
	6	200				
	2	300				
20C56*	8	250	60	3 1/2 x 3 1/4 x 4 1/4	6.75	6.47
	7	300				
	4	300				
26C41	1.5	200	90	1 1/2 x 1 1/2 x 2 1/2	0.75	1.47
26C42	4.2	50	200	1 3/4 x 1 3/4 x 2 1/2	0.5	1.76
26C43	2	200	50	2 x 1 1/4 x 3 1/4	1.0	2.06
26C44	1	300	60	2 x 2 1/2 x 3 1/4	1.5	2.35
26C45*	10	200	140	3 1/2 x 2 1/2 x 4 1/4	4.5	4.70

VERTICAL BLOCKING OSCILLATOR

Unit marked * constructed with two isolated secondaries.

THORD. NO.	TURNS RATIO	MTG. TYPE	SIZE	WT. LBS.	NET EACH
24A87	1:4.14	BAH	1 3/4 x 2 1/2 x 1 1/4	0.5	1.47
24A88	1:4.14	TAV	1 3/4 x 2 1/2 x 1 1/2	0.7	2.35
26A01*	1:0.48	BAH	1 3/4 x 2 1/2 x 1 1/2	1.0	2.35
26A02	1:1.5	BAV	1 3/4 x 1 1/4 x 2	0.5	1.47
26A03	1:4.2	BAH	1-3/16 x 1-2/16	0.5	1.47
26A04	1:4.2	XAV	1-9/16 x 1-3/16 x 1-3/16	0.75	1.88
26A05	1:3.5	BAH	1-3/16 x 1-2/16	0.75	1.53

HORIZONTAL BLOCKING OSCILLATOR

Thord. No.	Mtg. Type	Turns Ratio	Mtg. Ctra.	Size	Wt. Lbs.	Net Each
24A89	BAH	2:1	2	1 3/4 x 2 1/2 x 1 1/4	0.5	1.76
24A90	TAV	2:1	2	1 3/4 x 2 1/2 x 1 1/2	0.75	2.65

WIDTH AND LINEARITY CONTROLS

All controls are type IF except * which are type PR and are designed for "double action" width control circuits. Have one coil in parallel with flyback, the other in series with yoke.

THORD. NO.	IND. MM	RES.	NOTES	SIZE	NET EACH
WC-10	.065-.3	194		2x8/715	.73
WC-11	.065-.3	51		1 1/2 x 2 1/2 x 1 1/8	.73
WC-12	.8-7	17		2 1/2 x 3 1/2	.73
WC-13	4.2-30	22		2 1/2 x 7 1/2	.88
WC-14	5.5-20	34	AGC Winding	2x5 1/2	.73
WC-15	1.7-6	1		2 1/2 x 3 1/2	.59
WC-16	.55-2.3	8.3	Tapped	2-13/16 x 7/16	.73
WC-17	1.3-4.3	7	Tapped	2x5 1/2	.73
WC-18	2.5-17	18		2 1/2 x 3 1/2	.73
WC-19	10-50	40		2 1/2 x 3 1/2	.73
WC-20	2.6-7.0	1.2		2 1/2 x 3 1/2	.88
WC-21*	1.2-1.8	10	AGC Winding Parallel Coil Series Coil	3 1/4 x 5 1/2	1.76
WC-22	1.7-2	8		2 1/2 x 9/16	.88
WC-23	.5-3.5	2.3		2 1/2 x 1 1/2	.73
WC-24*	4.4-29	28	Parallel Coil Series Coil	2 1/2 x 9/16	1.76
	35-2.3	3.5			

VERTICAL OUTPUT TRANSFORMERS

All units are mounting type BAH except those marked * which are CAV. Items marked * are autotformer type.

THORD. NO.	TURNS RATIO	DC RES.	SEC	SIZE	WT. LBS.	NET EACH
24S86	10:1	618	6	3 1/2 x 2 1/2 x 2 1/2	2.5	3.88
26S81	10:1	1800	10.9	2 3/8 x 1 1/4	1.5	2.50
26S82*	11:4	1492	13.4	2 3/8 x 1 1/4	1.5	2.50
26S83	10:1	1053	8.4	2 1/4 x 3 1/4 x 2	2.5	2.94
26S84*	18:1	1960	4.5	2 1/4 x 3 3/4 x 2	2.5	3.23
26S85*	25:1	704	1.5	2 1/4 x 3 3/4 x 2	2.5	3.53
26S86	25:1	715	1.75	3 1/8 x 3 3/8 x 2 1/4	2.5	3.23
26S87	44:1	400	.3	3 x 2 1/2 x 2 3/8	2.25	3.97
26S70	5:1	285	8.2	2 3/8 x 1 3/4	1.5	1.94
26S71	6:1	160	8	2 1/4 x 3 3/4 x 2	2.5	2.66
26S72	8:1	395	6	2 1/4 x 3 3/4 x 2	2.5	2.65
26S73*	8:1	540	10	2 1/4 x 3 3/4 x 1 3/8	2.5	2.94

UNIVERSAL AUDIO OUTPUT

THORD. NO.	PRI-SEC IMPEDANCE	MA	MTG. TYPE	WT. LBS.	NET EACH
24S60	4000/7000/8000/10000/14000 CT/10 To 30	35	4 BHH 2	0.5	1.71
22S87	2000/3500/8000/14000 CT/To 30	10	8 BAH 2 3/8	0.75	2.65
22S88	2000/3500/8000/14000 CT/To 30	10	8 BAH 2 3/8	1	2.94
24S61	4000/7000/8000/10000/14000 CT/10 To 30	40	8 BHH 2 3/8	1	1.82
24S62	1500/2000/2500/3000/4000 CT/To 1 To 30	50	8 BHH 2 3/8	1.25	2.94
22S60	2500/4000 CT/To 1 To 30	60	10 BAH 2 3/8	1.25	2.94
22S58	5000/7000 CT/To 30	45	10 BAH 2 3/8	1.25	2.94
22S56	8000/10000 CT/To 30	35	10 BAH 2 3/8	1.25	2.94
26S46	10000/14000 CT/4000/7000/8000/10000/14000 CT/To 1 To 30	40	18 BHV 2 3/8	1.5	2.06

FIXED AUDIO OUTPUT

Units marked * are humbucking with 3% and 6% taps. All are BRH-BAV mounting types and have 3.2 ohms secondary. 26S59 also has 8 and 16 ohm secondary.

THORD. NO.	PRIMARY IMPEDANCE	WATTS	MTG. CTRS.	WT. LBS.	NET EACH
22S45	1500-2500	5	2	.5	1.76
22S46	6000-7000 CT	5	2	.5	2.06
22S47	6000-7000 CT	5	2	.5	2.06
24S48	4000-5000	5	1 1/2	.5	1.18
24S50	3500	8	2 1/2	.5	1.18
24S50A*	2000	5	2	.5	1.18
24S51	5000	5	2	.5	1.47
24S51A*	5000	5	2	.5	1.47
24S52	7000-1000	5	2	.5	1.18
26S47	14000 CT	12	2 3/4	1.0	1.76
26S48	7000	8	2 3/4	.75	1.47
26S49	5000	8	2 3/4	.75	1.47
26S50	3500	8	2 3/4	.75	1.47
26S58	2500	3	1 1/4	.4	.94
26S59	10000 CT	10	2 1/4	1.0	2.94

FILAMENT TRANSFORMERS

All primaries are 117 Volt 50/60 cycle except * which is 0.3V. All units are designed to RETMA standards and color code.

THORD. NO.	MTG. TYPE	SECONDARY VOLTS	AMPS	SHPG. INSL.	WT. LBS.	NET EACH
21F03	BAV	5 CT	3.0	2500	1.0	2.94
21F08	BAV	6.3 CT	1.0	2500	1.0	1.71
21F09	BAH	6.3 CT	1.2	2500	1.0	1.76
21F10	BAH	6.3 CT	3.0	2500	1.25	2.94
21F11	CAV	6.3 CT	6.0	2500	2.75	4.70
21F12	CAV	6.3 CT	19	2500	3.25	4.41
21F27	BAH	26.5 CT	1.6	3000	1.25	2.94
26F60	BAH	6.3 CT	1.2	5000	1.25	2.65
26F61	BAH	5 CT	3.0	2500	2.5	3.82
26F63	BAV	6.3	3.6	2500	2.0	4.41
26F64	GGV	25	3.0	3000	3.5	5.88
26F65*	BAH	6.3	1.2	3500	1.25	2.35
26F67	BAH	12.6 CT	3.0	2500	1.0	2.94
26F69	HKF	6.3	5	2500	3.0	5.29

SPECIAL QUANTITY PRICE

A special quantity price is available for three of the most popular filament transformers which are described above.

TYPE	Lots of 25	Lots of 50
21F08	1.47	1.32
21F09	1.47	1.32
26F60	1.99	1.84

FOCUS COILS

THORD. NO.	DC RES.	MA	SIZE	WT. LBS.	NET EACH
FC-1	215	200	3 3/4 x 1 1/2	2.0	4.70
FC-2	360	140	3 3/4 x 1 1/2	2.0	4.85
FC-3	470	100	4 1/4 x 1 1/2 x 1 1/2	3.0	6.17
FC-4	1000	75	3 3/4 x 1 1/2	2.0	6.17

REPLACEMENT FLYBACK TRANSFORMERS

Thordarson exact replacement flyback transformers are built to the manufacturers specifications and exactly duplicate electrical and physical characteristics.

THORD. NO.	Original Mfrs. Part Nos.	Net Each
FLY-1	RCA 211T1, 211T3	5.59
FLY-3	GE 77J1	5.88
FLY-4	211-TE	5.88
FLY-6	Admiral 79C30-2, -4 79C38-1, 79D38-1	6.12
FLY-7	Westinghouse V990-1, D204-1 10213-1, 10214-1	5.88
FLY-8	Emerson 73S06, 7380-0, 64	6.17
FLY-10	Admiral 79C80-1, -3	6.17
FLY-11	Philco 32-8555, 32-8572	5.88
FLY-12	RCA 225T1	5.88
FLY-13	Emerson 73S067, 68, 69, 73, 75	6.17
FLY-14	RCA 230T1	5.88
FLY-15	RCA 231T1	6.47
FLY-16	RCA 236T1: CBS PC-10155	6.76
FLY-17	Philco 32-8934	5.88
FLY-19	GE RTO-146, -3	5.88
FLY-20	Motorola 24C730-02, 24K7300-04	6.47
FLY-21	Admiral 79D41-1, -2	5.88
FLY-22	Sylvania 241-0003, 241-0005, 241-0006	4.70
FLY-23	Sylvania 241-0007	4.70
FLY-24	RCA 76795	6.47
FLY-25	Crosley 157B20-5-1, 158481-1, -2, -5, -8-5, 158412-1-3	4.70
FLY-27	Philco 32-8-65, 32-8607	6.47
FLY-29	Motorola 24C711652, 24C701562, 24C701636	6.76
FLY-30	Philco 32-8-09, 32-8465, -2	7.06
FLY-31	Philco 32-8-09-2, 32-8484-2	7.06
FLY-32	Motorola 24A790184, 24C790184, 24K791974	6.47
FLY-33	Motorola 24C701134, 24C710836, 24C792396, D, 24K700588, 24K701099, 24K792753, D	6.17
FLY-38	RCA 232T1	7.35
FLY-40	Motorola 24C792691	3.82
FLY-43	RCA 76501	3.82
FLY-44	RCA 231T1 with AGC	7.06
FLY-45	RCA 75240, 75519, 75585, 6154, 76981	4.12
FLY-46	Emerson 73S034	6.17
FLY-47	Philco 32-8-28, -1, -2	7.35
FLY-48	Philco 32-8453, -3	7.35
FLY-52	Zenith S-16-66, 17140, 17233, 17245, 17566, 17227, 17939, 18128, 18487, 18537	5.88
FLY-53	Zenith S-15-15, 15709, 15911, 15912, 16191, 16204, 17130, 17244, 17265, 17689, 17767, 7812	5.88
FLY-55	Philco 32-3-33, 32-3514	6.47
FLY-57	Motorola 24K735868	

CAPACITORS CORNELL DUBILIER



SPRAGUE "ATOMS" TYPE TVA

Compact, dry electrolytic capacitor designed for radio and TV replacement requirements. Has low leakage and can withstand high temperatures, ripple currents and surge voltages.

CORNELL-DUBILIER "BLUE BEAVER" TYPE BR

Small, handy, dry electrolytic service replacement capacitors. Sealed in aluminum can with wax impregnated cardboard outer sleeve indicating polarity. Conveniently mounted.

AEROVOX "DANDEE" TYPE PRS

Compact, electrolytic tubular for radio and TV applications. Etched foil design and vented for excessive gas pressures. In aluminum can with cardboard insulating sleeve.

MALLORY TYPE TC

Dry electrolytic capacitors for filter and audio bypass applications. Sealed in aluminum tube and having external cardboard insulating sleeve.

SINGLE SECTION

Stock No.	Cap. Mfd.	W.V.	Sprague TVA	C-D BR	AeroVox PRS	Mallory TC	Net ea.	Stock No.	Cap. Mfd.	W.V.	Sprague TVA	C-D BR	AeroVox PRS	Mallory TC	Net ea.
Z60	1000	3				310	1.00	Z118	300	150			PRS		1.50
Z61	2000	4					1.35	Z119	4	250	1501		PRS		.59
Z62	50	6	1100				.56	Z120	5	250			PRS	50X	.62
Z63	100	6	1101				.71	Z121	8	250	1503		PRS		.68
Z64	250	6	1102	H6025	PRS		.79	Z122	10	250	1304		PRS		.82
Z65	500	6	1103	605	PRS	605	.91	Z123	12	250	1505		PRS	54	.73
Z66	1000	6	1104	H810	PRS	610	1.12	Z124	16	250	1507		PRS	54	.76
Z67	1500	6	1105				1.23	Z125	20	250	1508		PRS	55	.79
Z68	2000	6	1106	620	PRS		1.35	Z126	30	250	1510		PRS		.85
Z69	100	12	1130	121	PRS		.71	Z127	4	350	1511		PRS	58	.91
Z70	250	12	1131	H1225	PRS		.85	Z128	60	250			PRS	59	1.00
Z71	500	12	1132	125	PRS		1.00	Z129	60	250			PRS		1.06
Z72	1000	12	1133	1210	PRS		1.32	Z130	4	350	1601		PRS		.62
Z73	2000	12	1134	1220	PRS		1.36	Z131	5	350			PRS	60	.62
Z74	100	15	1160	161	PRS		.73	Z132	8	350	1603		PRS	61	.71
Z75	200	15				1502	.82	Z133	10	350	1604		PRS	62	.73
Z76	250	15	1161	1525	PRS		.91	Z134	16	350	1605		PRS	63	.76
Z77	500	15	1162	1535	PRS	1505	1.03	Z135	16	350	1607		PRS	64	.82
Z78	1000	15	1163	1610	PRS		1.35	Z136	20	350	1608		PRS	65	.85
Z79	2000	15	1164	1520	PRS		1.68	Z137	24	350			PRS		.91
Z80	2	25	1201				.53	Z138	30	350	1610		PRS		.97
Z81	5	25	1203				.59	Z139	40	350	1611		PRS		1.03
Z82	15	25	1204			22	.59	Z140	50	350			PRS		1.09
Z83	16	25		102	PRS		.59	Z141	60	350	1613		PRS	68	1.15
Z84	20	25					.59	Z142	1	450			PRS		.65
Z85	25	25	1205	252	PRS	26	.59	Z143	2	450	1701		PRS		.65
Z86	50	25	1206	502	PRS	29	.65	Z144	4	450	1702		PRS		.68
Z87	100	25	1207	251	PRS	2501	.79	Z145	20	450	1703		PRS	70	.70
Z88	150	25	1208	2525	PRS		1.00	Z146	8	450	1704		PRS	71	.73
Z89	500	25	1209	253	PRS	2505	1.35	Z147	16	450	1705		PRS	72	.76
Z90	1	50	1300			31	.53	Z148	12	450	1706		PRS	73	.79
Z91	2	50	1301			302	.53	Z149	16	450	1708		PRS	74	.82
Z92	5	50	1303	550	PRS	30	.59	Z150	20	450	1709		PRS	75	.81
Z93	10	50	1304	105	PRS	32	.59	Z151	30	450	1711		PRS	77	1.00
Z94	20	50		205	PRS		.59	Z152	40	450	1712		PRS	78	1.06
Z95	25	50	1306	255	PRS	36	.62	Z153	50	450	1713		PRS	79	1.23
Z96	50	50	1308	505	PRS	39	.71	Z154	60	450			PRS		1.38
Z97	100	50	1310	501	PRS	3501	.82	Z155	80	450	1716		PRS	80	1.55
Z98	150	50	1311	H5015	PRS		.91	Z156	100	450			PRS		1.88
Z99	250	50	1312	H5025	PRS	50025	1.03	Z157	10	475	1802		PRS		.79
Z100	500	50	1400	5050	PRS		1.41	Z158	20	475	1804		PRS		.94
Z101	4	150	1402	415	PRS		.59	Z159	4	500			PRS		.71
Z102	6	150				40	.59	Z160	8	500	1902		PRS		.76
Z103	8	150	1405	815	PRS	41	.62	Z161	10	500			PRS	81	.82
Z104	10	150	1406	1015	PRS	42	.62	Z162	12	500			PRS		.86
Z105	12	150	1407	1215	PRS	43	.68	Z163	16	500	1905		PRS		.88
Z106	15	150	1408	1615	PRS	44	.68	Z164	20	500	1906		PRS	83	.94
Z107	20	150	1410	2015	PRS	45	.71	Z165	30	500			PRS	84	1.03
Z108	24	150					.73	Z167	8	600			PRS		.82
Z109	25	150		2515			.73	Z168	10	600			HV610		.85
Z110	30	150	1412	3015	PRS	47	.76	Z169	12	600			PRS		.88
Z111	40	150	1413	4015	PRS	48	.79	Z170	16	600			PRS		.97
Z112	50	150	1414	5015	PRS	49	.82	Z171	20	600			PRS		1.00
Z113	60	150		6015	PRS		.88	Z172	8	700			PRS		.88
Z114	80	150	1418	8015	PRS	492	.94	Z173	10	700			PRS		.91
Z115	100	150	1420	10015	PRS		1.03	Z174	12	700			PRS		.94
Z116	150	150	1422	15015	PRS	495	1.12	Z175	16	700			PRS		1.03
Z117	200	150			PRS		1.28								

DUAL SECTION - COMMON NEGATIVE

Stock No.	Cap. Mfd.	W.V.	Sprague TVA	C-D BBRD	AeroVox PRS	Mallory TCD	Net ea.	Stock No.	Cap. Mfd.	W.V.	Sprague TVA	C-D BBRD	AeroVox PRS	Mallory TCD	Net ea.		
Z200	10-10	25	2210		PRS		.82	Z220	100-100	150			PRS		1.68		
Z201	20-20	25		2202	PRS		.82	Z221	8-8	200			PRS		.86		
Z202	25-25	25			PRS	26	.82	Z222	8-16	200			PRS		1.00		
Z203	10-10	150	2315	115	PRS		.88	Z223	16-16	200			PRS		1.15		
Z204	8-8	150	2416		PRS		.91	Z224	30-30	200			PRS		1.26		
Z205	8-16	150			PRS		1.06	Z225	8-8	250			FD25		.94		
Z206	16-16	150	2420		PRS		.94	Z226	10-10	250			PRS	52	.97		
Z207	20-10	150		2115	PRS	45	.91	Z227	16-8	250			PRS		.97		
Z208	20-12	150	2425		PRS		1.00	Z228	16-16	250			16D25		1.73		
Z209	20-20	150	2428		PRS		1.06	Z229	20-20	250	2515		2225	PRS	55	1.09	
Z210	30-20	150	2421		PRS		1.00	Z230	30-30	250			3525	PRS	1.32		
Z211	30-30	150	2434		PRS	47	1.06	Z231	40-10	250	2520				1.21		
Z212	40-20	150	2438		PRS	48.5	1.03	Z232	75-20	250			TV225		1.53		
Z213	40-30	150	2442		PRS		1.06	Z233	80-10	250	2525				1.50		
Z214	40-40	150	2445		PRS	48	1.06	Z234	10-10	350					1.00		
Z215	50-30	150	2450		PRS		1.15	Z235	20-20	350					1.32		
Z216	50-50	150	2453		PRS		1.29	Z236	8-8	450	2720			RD45	PRS	73	1.00
Z217	80-30	150	2460		PRS		1.29	Z237	10-10	450	2722			PRS	72	1.09	
Z218	80-40	150		8415	PRS	498	1.38	Z238	15-15	450				PRS	74	1.29	
Z219	80-50	150			PRS		1.68	Z239	16-8	450	2725			16R45	PRS	74	1.18
Z220	100-100	150		101015	PRS		1.88	Z240	16-16	450				16D45	PRS	75	1.47
Z221	8-8	200			PRS		.86	Z241	20-20	450	2730			2245	PRS	75	1.76
Z222	8-16	200			PRS		1.09	Z242	30-30	450	2735			3345	PRS	1.76	
Z223	16-16	200			PRS		1.15	Z243	40-20	450				PRS		1.76	
Z224	30-30	200			PRS		.65	Z244	40-40	450	2740			4443	PRS	78	2.00
Z225	8-8	250			PRS		.65	Z245	50-30	450				PRS		2.00	
Z226	10-10	250			PRS		.68										
Z227	16-8	250			PRS		.71										
Z228	16-16	250			PRS		.72										
Z229	20-20	250	2515		PRS		.72										
Z230	30-30	250			PRS		.73										
Z231	40-10	250	2520		PRS		.74										
Z232	75-20	250			PRS		.81										
Z233	80-10	250	2525		PRS		.77										
Z234	10-10	350			PRS		.78										
Z235	20-20	350			PRS		.79										
Z236	8-8	450	2720		PRS		1.38										
Z237	10-10	450	2722		PRS		1.55										
Z238	15-15	450			PRS		1.88										
Z239	16-8	450	2725		PRS		.79										
Z240	16-16	450			PRS		.94										
Z241	20-20	450	2730		PRS		.71										
Z242	30-30	450	2735		PRS												

SPRAGUE AEROVOX MALLORY

Lafayette

LAFAYETTE

MOLDED BY-PASS CONDENSERS

LAFAYETTE

TUBULAR ELECTROLYTICS

EVERY CONDENSER SOLD ON MONEY BACK GUARANTEE

For general replacement service, extremely durable and very compact. Have high insulation resistance. Molded in extra hard, non-flammable plastic, resistant to moisture, high temperature and shock. Extra strong copper weld leads eliminate breakage during installation. Temperature range -40° to 90° C. Made by a leading condenser manufacturer.

The New Lafayette electrolytic capacitors are specifically designed for service replacement application. All are sealed in aluminum cans. All have wax impregnated cardboard outer insulating sleeves, have solid tinned copper wire leads with negative terminal grounded to can. Guaranteed for operation as high as 85° C. ONE OF THE BEST CONDENSERS ON THE MARKET TODAY, AND AT A CONSIDERABLE SAVING TO YOU!



Stock No.	Mfd.	Voltage	Price Ea.	Price in lots of 10	Box of 100
C500	.001	600	9¢	8¢ Each	5.95
C501	.002	600	9¢	8¢	5.95
C502	.005	600	9¢	8¢	5.95
C503	.01	600	10¢	9¢	6.95
C507	.02	600	10¢	9¢	6.95
C508	.03	600	11¢	10¢	7.50
C505	.05	600	11¢	10¢	8.50
C506	.1	600	16¢	14¢	11.95
C525	.005	1600	12¢	11¢	8.50
C526	.008	1600	14¢	12¢	9.50
C527	.01	1600	15¢	13¢	9.95
C528	.05	1600	24¢	21¢	19.00

Stock No.	Mfd.	W. V.	Net Each	Price in lots of 10
C-128	10	25	29¢	27¢ Each
C-129	25	25	31¢	29¢
C-100	20	150	33¢	31¢
C-101	40	150	36¢	24¢
C-113	8	450	37¢	34¢
C-130	20	450	47¢	45¢
C-131	40	450	55¢	52¢
C-127	20-20	150	42¢	39¢
C-125	30-30	150	45¢	42¢
C-126	40-40	150	49¢	45¢
C-102	50-30	150	49¢	45¢
C-106	50-50	150	55¢	52¢

MOLDED TUBULAR CAPACITORS

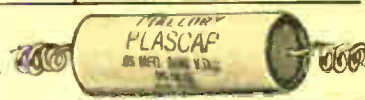
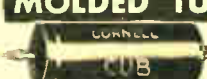

SPRAGUE BLACK BEAUTY TELECAP

CORNELL-DUBILIER CUB TYPE

AEROVOX DURANITE TYPE P88N

MALLORY PLASCAP TYPE PT

Stock No.	Cap. Mfd.	Sprague Type 2TM	C-D Type 2Cub	Aerovox Type P88N	Mallory Type PT	Net Ea.
Z500	.02	S2	2S2	P88N		.15
Z501	.047	S47	2S47	P88N		.15
Z502	.05	S5	2S5	P88N		.15
Z503	.1	P15	2P15	P88N		.21
Z504	.15	P15	2P15	P88N		.21
Z505	.22	P22	2P22	P88N		.24
Z506	.25	P25	2P25	P88N		.24
Z507	.33			P88N		.29
Z508	.47	P47	2P47	P88N		.35
Z509	.5	P5	2P5	P88N		.35
Z510	1.0	M1	2M1	P88N		.53

Stock No.	Cap. Mfd.	Sprague Type 6TM	C-D Type 6Cub	Aerovox Type P88N	Mallory Type PT	Net Ea.
Z578	.068	S68	6S68	P88N		.24
Z579	.075			P88N		.26
Z580		P1	6P1	P88N	601	.26
Z581	.15	P15	6P15	P88N		.29
Z582	.2	P2	6P2	P88N		.32
Z583	.22	P22	6P22	P88N		.32
Z584	.25	P25	6P25	P88N	6025	.32
Z585	.47			P88N	6017	.47
Z586	.5	P5	6P5	P88N	605	.47
Z587	1.0			P88N	61	.73

Stock No.	Cap. Mfd.	DC Working Volts	Sprague	Cornell-Dubilier	Net Ea.
Z675	.0005	6000	TVM-356	60T5	.78
Z676	.001	6000	TVM-216	60D1	.79
Z677	.005	6000	TVM-256	60D5	.79
Z678	.0005	10,000	TVM-461	100T5	.88
Z679	.00025	12,500	12TVM-325	125T25	1.00

Stock No.	Cap. Mfd.	Sprague Type 4TM	C-D Type 4Cub	Aerovox Type P88N	Mallory Type PT	Net Ea.
Z520	.001			P88N		.15
Z521	.0068			P88N		.15
Z522	.0075			P88N		.15
Z523	.01	S1	4S1	P88N	411	.15
Z524	.015	S15		P88N		.15
Z525	.02	S2	4S2	P88N	412	.15
Z526	.022	S22	4S22	P88N	4122	.15
Z527	.025	S25		P88N		.15
Z528	.03	S3		P88N	413	.18
Z529	.033			P88N	4133	.18
Z530	.04	S4		P88N		.18
Z531	.047	S47	4S47	P88N	4147	.18
Z532	.05	S5	4S5	P88N	415	.18
Z533	.068	S68	4S68	P88N	401	.21
Z534	.1	P1	4P1	P88N	4015	.21
Z535	.15	P15	4P15	P88N		.21
Z536	.2	P2		P88N	402	.24
Z537	.22	P22	4P22	P88N	4022	.24
Z538	.25	P25	4P25	P88N	4025	.24
Z539	.47	P47	4P47	P88N	4037	.35
Z540	.5	P5	4P5	P88N	403	.35
Z541	1.0	M1	4M1	P88N		.53

Stock No.	Cap. Mfd.	Sprague Type 10M	C-D Type 10Cub	Aerovox Type P88N	Mallory Type PT	Net Ea.
Z600	.0005	T5		P88N		.29
Z601	.001	D1		P88N		.29
Z602	.0015	D15		P88N		.29
Z603	.002	D2		P88N		.29
Z604	.0022	D22		P88N		.29
Z605	.003	D3		P88N		.29
Z606	.0033	D33		P88N		.29
Z607	.0047	D47		P88N		.29
Z608	.005	D5		P88N		.29
Z610	.006			P88N		.29
Z611	.0068	D68		P88N		.29
Z612	.0075			P88N		.29
Z613	.01	S1		P88N		.29
Z614	.015	S15		P88N		.29
Z615	.02	S2		P88N		.29
Z616	.022	S22		P88N		.29
Z617	.025	S3		P88N		.29
Z618	.03			P88N		.29
Z619	.033			P88N		.35
Z620	.035	S35		P88N		.35
Z621	.04	S47		P88N		.35
Z622	.047	S5		P88N		.35
Z623	.05	S5		P88N		.35
Z624	.06	S68		P88N		.35
Z625	.065	P1		P88N		.38
Z626	.1			P88N		.44



SPRAGUE TYPE 68P MIDGET TUBULARS

Small size paper capacitors with humidity protection and operating at 85° C. Suited for use in electronic assemblies that require high temperature operation, good humidity performance, minimum size and moderate cost. Ideal replacements for midget radios and auto radios.

Stock No.	Cap. Mfd.	Sprague Type 6TM	C-D Type 6Cub	Aerovox Type P88N	Mallory Type PT	Net Ea.
Z550	.0001	T1	6T1	P88N		.15
Z551	.00025	T15	6T15	P88N		.15
Z552	.0004	T4	6T4	P88N		.15
Z553	.0005	T5	6T5	P88N		.15
Z554	.001	D1	6D1	P88N	621	.15
Z555	.0015	D15	6D15	P88N		.15
Z556	.002	D2	6D2	P88N	622	.15
Z557	.0022	D22	6D22	P88N	6222	.15
Z558	.003	D3	6D3	P88N	623	.15
Z559	.0033	D33	6D33	P88N	6233	.15
Z560	.004	D4	6D4	P88N	624	.15
Z561	.0047	D47	6D47	P88N	6247	.15
Z562	.005	D5	6D5	P88N	625	.15
Z563	.006	D6	6D6	P88N	626	.15
Z564	.0068	D68	6D68	P88N		.15
Z565	.007			P88N		.15
Z566	.0075			P88N		.15
Z567	.01	S1	6S1	P88N	611	.18
Z568	.015	S15	6S15	P88N	6115	.18
Z569	.02	S2	6S2	P88N	612	.18
Z570	.022	S22	6S22	P88N	6122	.18
Z571	.025			P88N		.21
Z572	.03	S3	6S3	P88N	613	.21
Z573	.033	S33	6S33	P88N	6133	.21
Z574	.04	S4	6S4	P88N	614	.21
Z575	.047	S47	6S47	P88N	6147	.24
Z576	.05	S5	6S5	P88N	615	.24
Z577	.06	S6	6S6	P88N	616	.24

Stock No.	Cap. Mfd.	Sprague Type MB	C-D Type Cub	Aerovox Type P88N	Net Ea.
Z640	.005	T5	16T5		.38
Z641	.0091	D1	16D1	P88N	.38
Z642	.0015	D15	16D15	P88N	.38
Z643	.002	D2	16D2	P88N	.38
Z644	.0022	D22	16D22	P88N	.38
Z645	.003	D3	16D3	P88N	.38
Z646	.0033	D33	16D33	P88N	.38
Z647	.004	D4	16D4	P88N	.38
Z648	.0047	D47	16D47	P88N	.38
Z649	.005	D5	16D5	P88N	.38
Z650	.006	D6	16D6	P88N	.38
Z651	.0068	D68	16D68	P88N	.38
Z652	.007	D7	16D7	P88N	.38
Z653	.0075	D75	16D75	P88N	.38
Z654	.008	D8	16D8	P88N	.38
Z655	.01	S1	16S1	P88N	.41
Z656	.015	S15	16S15	P88N	.41
Z657	.02	S2	16S2	P88N	.41
Z658	.022	S22	16S22	P88N	.41
Z659	.025			P88N	.41
Z660	.03	S3	16S3	P88N	.41
Z661	.033			P88N	.41
Z662	.04	S4	16S4	P88N	.41
Z663	.05		16S5	P88N	.41

No.	Type	Mfd.	Size	Each
Z700	68P10	.25	1 5/32x1 1/8"	.41
Z701	68P20	.5	5/8x1 1/8"	.47

Stock No.	Cap. Mfd.	Type	Size	Each
Z702	68P11	.005	1 4/41x1 1/16"	.21
Z703	68P12	.006	1 4/41x1 1/16"	.21
Z704	68P14	.01	9/32x1 1/16"	.26
Z705	68P15	.02	9/32x1 3/16"	.26
Z706	68P16	.05	5/16x1"	.29
Z707	68P17	.1	13/32x1"	.35
Z708	68P18	.2	15/32x1 1/8"	.38
Z709	68P24	.25	1 7/32x1 1/8"	.41
Z710	68P25	.5	5/8x1 1/8"	.47

Stock No.	Cap. Mfd.	Type	Size	Each
Z711	68P1	.001	1 4/41x1 1/16"	.21
Z712	68P3	.003	1 4/41x1 1/16"	.21
Z713	68P4	.004	1 4/41x1 1/16"	.21
Z714	68P5	.005	1 4/41x1 1/16"	.21
Z715	68P6	.006	1 4/41x1 1/16"	.21
Z716	68P8	.01	5/16x1 3/16"	.24
Z717	68P9	.02	5/16x1"	.26
Z718	68P10	.05	13/32x1"	.29
Z719	68P21	.1	15/32x1 1/8"	.38
Z720	68P38	.2	5/8x1 1/8"	.41
Z721	68P22	.25	5/8x1 3/8"	.44
Z722	68P23	.5	5/8x2 1/8"	.47

Stock No.	Cap. Mfd.	Type	Size	Each
Z723	68P26	.001	1 4/41x1 1/16"	.21
Z724	68P27	.002	1 4/41x1 1/16"	.21
Z725	68P28	.003	9/32x1 1/16"	.21
Z726	68P29	.004	9/32x1 3/16"	.21
Z727	68P30	.005	9/32x1 3/16"	.24
Z728	68P31	.006	5/16x1 3/16"	.24
Z729	68P32	.008	5/16x1"	.24
Z730	68P34	.01	5/16x1"	.26
Z731	68P34	.02	11/32	

* PORCELAIN CASED TUBULAR CAPACITORS *

New!

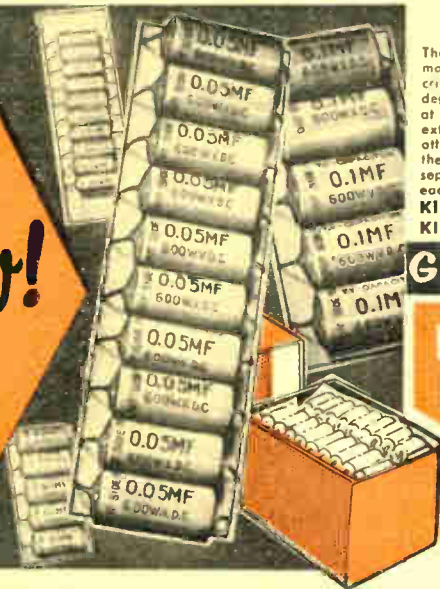

- TESTED AT 3 TIMES WORKING VOLTAGE
- EXCEPTIONALLY RESISTANT TO HIGH TEMPERATURES AND MOISTURE
- SURPASSES PERFORMANCE OF MOLDED PLASTIC TUBULARS

They're new, they're different, and they're better! Now, at a price far less than that of ordinary plastic molded tubulars, Lafayette brings you, for every day service work, a condenser that was designed for critical industrial applications. The case is of durable gleaming porcelain, a ceramic known for its high degree of imperviousness to moisture and resistance to heat. The capacitor is of finest quality, tested at 3 times the rated voltage with much closer capacity tolerance. It maintains its characteristics under extreme conditions of heat and humidity. It's mechanical construction is excellent, the leads are firmly attached and sealed — they won't twist or break off. We've selected the most popular values and put them up in two serviceman designed kits. Each condenser is plainly marked. Each value is mounted on separate handy strips. All are conservatively rated at 600 DC working volts. See chart for contents of each kit.

KI-51 Kit of 50 **2.95**
 KI-52 Kit of 100 **5.45**

Greatest Condenser Value Ever Offered!

KIT OF 100
 600V W V DC

QTY	MFD
10	.001
10	.002
10	.005
20	.01
20	.02
20	.05
10	.1

List Value **\$32.00**

\$5.45

SPECIAL NET

KIT OF 50
 600V W V DC

QTY	MFD
5	.001
5	.002
5	.005
10	.01
10	.02
10	.05
5	.1

List Value **\$16.00**

\$2.95

SPECIAL NET

stock up on this Terrific Condenser Value!

- Guaranteed
- Brand New

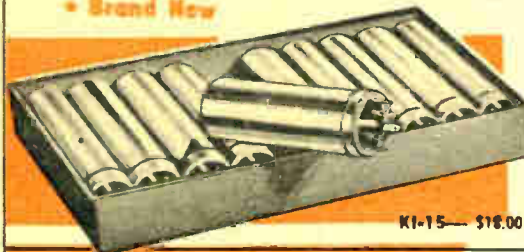

KI-15—\$18.00 Value For Only

Kit of 10 aluminum can, twist prong, plug-in and screw neck electrolytics — Contains single, dual and triple section units in assorted values and voltages. Regular value \$15.00. All 10 cost you less than the normal price of just two if bought regularly. Quantities are limited—suggest you stock up now, as at this remarkably low price they will go fast.

KIT OF 10 ELECTROLYTICS

2.45

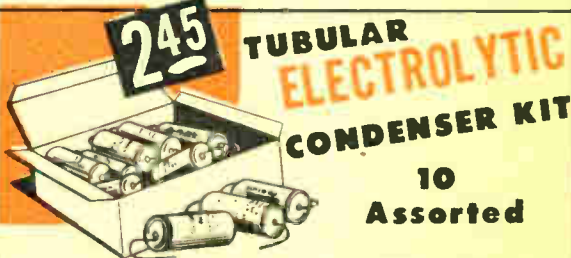

TUBULAR ELECTROLYTIC CONDENSER KIT

10 Assorted

Now's the time to save on this top-quality electrolytic tubular condenser kit. Consists of single, dual and triples of the most popular sizes used in all service repair work. Every condenser brand new, finest quality, and guaranteed to be worth at least twice as much!

STOCK No. KT-14, Kit of 10 Assorted

Tubular Electrolytics **\$2.45**

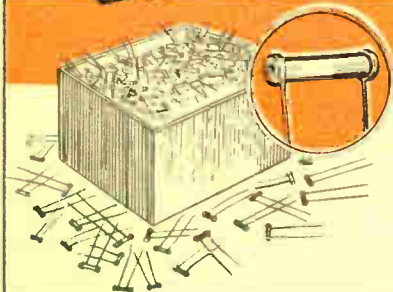

TUBULAR CERAMIC COND. KIT 100 PIECES

Compare the price of this kit with any other you see advertised anywhere. You pay only 1/2¢ each for this assortment of color coded top quality ceramics. Shpg. Wt. 1 lb.

KI-47.....Net **1.49**

KIT OF 25 TUBULAR BY-PASS CONDENSERS

An assortment of 25 tubular by-pass condensers made by the leading condenser manufacturers in the country. Top quality, brand new. Consist of the most popular capacities and voltages. With long leads for easy connections. Meet all RMA standards. Lafayette has sold thousands of these kits and orders keep on pouring in! Guaranteed to be worth at least twice as much as our price.

STOCK No. KI-14, Kit of 25 Tubular By-Pass Condensers



69¢



MICA KIT 50 CONDENSERS

Big Savings

99¢

In lots of 3

A kit of the most popular mica capacitors for servicemen. Contains 50 popular sizes. A handy assortment for any service shop or experimenter.

Stock No. KI-10, single, each **1.19 ea.**

CERAMICON KIT

25 ASSORTED
 STOCK NO. KI-13



Here is a real buy! Genuine CRL and Eric assorted tubular and disc ceramicon condensers. All condensers popular sizes, used in TV and FM sets. At Lafayette's low price every service shop should have at least one of these kits.

Complete kit of 25 **89¢ ea.**
 In lots of 6 **79¢ ea.**

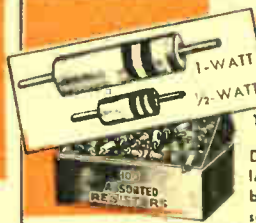

INSULATED RESISTOR KIT

100 Pieces—RMA Color Coded Regular List Price 15.80

Do not confuse with non-insulated foreign makes, etc., offered by others. Contains a carefully selected assortment of 100 insulated resistors. Standard RMA color code. Included are 70—1/2 watt; 20—1 watt end 10—2 watt resistors.

Stock No. KI-11
\$159
 SPECIAL! **ea.**

Handsomely packed.



TRADE STARTLED AT Lafayette's PRICES!

UNIVERSAL 6 and 12 V. VIBRATORS



6 VOLT—4 PRONG
Standard 4 prong non-synchronous. Replaces Mallory 294, 859, 901M, Radiart 5300, 5301 etc. Shpg. Wt. 1/2 lb.
MS-14—In lots of 100, Each .99
In lots of 10, Each 1.19
Singly, Each 1.29

12 VOLT—3 PRONG
Replaces Buick Olds, Pontiac, and G.M. part 1220155, Mallory G874, CD6330 and Voker 3129. Shpg. Wt. 1/2 lb.
MS-127—In lots of 100, each 1.39
In lots of 10, each 1.59
Singly, each 1.70

12 VOLT—4 PRONG
Replaces Motorola 488522000, Philco and Mopar 83-0025-1, Mallory G-859, Voker 4124. Shpg. Wt. 1/2 lb.
MS-128—In lots of 100, each 1.29
In lots of 10, each 1.42
Singly, each 1.55

A GREAT BUY!

LRG & ALLEN-BRADLEY Resistors

Lafayette leads again with a great buy on LRG & Allen Bradley RMA color coded insulated resistors. These resistors are not surplus; they are BRAND NEW, purchased direct from the factory and for the first time at a price that enables laboratories, industrials and servicemen to use the finest resistor made for ordinary use.

VALUES AVAILABLE AT ±10% TOLERANCE

Ohms	Ohms	Ohms	Ohms	Meg	Megs	Megs
10	100	1,000	10,000	0.1	1.0	10
12	120	1,200	12,000	0.12	1.2	12
16	150	1,600	16,000	0.15	1.5	15
18	180	1,800	18,000	0.18	1.8	18
22	220	2,200	22,000	0.22	2.2	22
27	270	2,700	27,000	0.27	2.7	—
33	330	3,300	33,000	0.33	3.3	—
39	390	3,900	39,000	0.39	3.9	—
47	470	4,700	47,000	0.47	4.7	—
56	560	5,600	56,000	0.56	5.6	—
68	680	6,800	68,000	0.68	6.8	—
82	820	8,200	82,000	0.82	8.2	—

5206A—1/2 watt
10% tolerance
Net 5c each
lots of 10.....45c
lots of 100.....3.99

5207A—1 watt
10% tolerance
Net 7c each
lots of 10.....60c
lots of 100.....5.50

5263A—2 watt
10% tolerance
Net 12c each
lots of 10.....1.10
lots of 100.....10.00



FREE
Here is your chance to get absolutely FREE a Transparent Plastic Utility Box with hinged cover size: 8 1/4" x 4 1/4" x 1-3/16" for storing your resistors FREE with purchase of 100 assorted resistors.



455 KC UNIVERSAL I.F. TRANSFORMER
While they last—Lafayette made a buy on brand new, first quality 455 KC — I.F. transformers, excellent for replacement in most sets. Aluminum shield 1 1/4" x 1 1/4" x 2 1/2" high — Top brand make—Trimmer adjustment top of can.
MS-17.....Net 29c ea.
In lots of 10—2.50

A FABULOUS BUY! GENUINE LRG and ALLEN-BRADLEY Resistor Kit



10% TOLERANCE
1/2 Watt RMA Color Coded
100 INSULATED RESISTORS

with PLASTIC HINGED BOX!

QUANT.	OHMS
3	100
3	470
3	1,000
3	2,200
3	4,700
4	10,000
4	22,000
4	27,000
4	33,000
4	47,000
10	1 meg
4	.15 meg
4	.27 meg
10	.47 meg
4	1 meg
4	2.2 meg
4	Other popular values
20	

\$4.50

Lafayette leads the field with a genuine Allen Bradley and LRG 1/2 watt, 10% tolerance, molded resistor kit with a Transparent Plastic Utility Box (built in parts) size: 8 1/4" x 4 1/4" x 1-3/16". The finest resistors on the market. Molded in finest composition, including salt water. Humidity and high humidity tests.
Stock No. K1-23—Total 100 molded resistors with Transparent Plastic Case.....NET **4.50 100 TOTAL**

SELENIUM RECTIFIER



Most popular sizes for radio and TV. Famous brand. All fresh, new stock. Input voltage 130 volts. You can't go wrong at these prices.

Stock No.	Mill	Each	Lots of 10
RE-12	65 MA	.57	.55
RE-14	75 MA	.67	.64
RE-10	100 MA	.80	.75
RE-15	150 MA	.92	.85
RE-16	200 MA	1.19	1.08
RE-11	250 MA	1.29	1.19
RE-17	300 MA	1.39	1.29
RE-18	350 MA	1.57	1.50
RE-13	400 MA	1.75	1.68
RE-19	450 MA	1.77	1.70
RE-20	500 MA	1.85	1.75



7 PIN MIN SOCKET .05 QUANTITY LIMITED

Saddle mounted bakelite socket for 7 pin miniature tubes. Mounting centers 1/4".
SP-91—Each .05
10 for .39
100 for 3.00



455 KC UNIVERSAL I.F. TRANSFORMER 49c ea. Only 1/4" Square

The most popular replacement I.F. at half the regular price! Exceptionally high gain powdered iron core, compression tuned, 455 KC midrange—only 1/4" square by 1 1/2" high. For both input and output circuits. Supplied with mounting clip and adapter plate to replace both midrange and larger size cans. Shpg. Wt. 4.0ss.
Stock No. MS-22, singly, ea. 59c
Lots of 10, ea. 49c

TV TUBE CHECKER

- CHECKS ALL TV TUBES
- CHECKS PICTURE TUBES
- CONTINUITY CHECKER
- CHECKS ELEC. APPLIANCES

2.75



Gives immediate positive check of burned out filament on all triode, octal and miniature tubes. Continuity test on picture tubes. Also checks continuity on fuses, resistors, line cords, appliances, motors, etc. Neon indicator, Metal case. Complete with Test Leads.
GC No. 9270 2.75
FS-105-ac interlock cord for above .29

LONG SHAFT CONTROL WITH SWITCH



FAMOUS BRAND
VC-10, 1 Meg. } Audio Taper
VC-11, 1/2 Meg. }
Each .49c

Lots of 10, **39c**

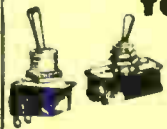

TOGGLE SWITCH Special!

Approved type with nickel-plated metal parts. Fast action—excellent for appliances, radio receivers, etc. Underwriters Approved.

Stock No.	Type	Amp.	Volt	Each
SW-10	SPST	6	125	.36
SW-11	SPDT	6	125	.48
SW-12	DPST	6	125	.66
SW-13	DPDT	6	125	.76

AND DON'T FORGET LAFAYETTE'S MONEY BACK GUARANTEE

STOCK UP NOW AT THESE LOW PRICES!

NEUTRALIZING TOOL KIT

SALE

REGULAR VALUE ~~4.50~~

WHILE THEY LAST **1.95**

14 INSULATED TOOLS

Here's what you get in this deluxe kit. Screwdriver with flexible shaft; 6" screw driver with metal nib; alligator side wrench; 1/2" and 3/4" nut wrench; 1/4" hex metal side wrench; 1/4" square nut wrench; 2 1/2" screwdriver with metal nib; 1/4" hex slotted wrench; 1/2" hex nut wrench; metal screw driver; 5" and 6" screwdrivers, and leatherette case. Shpg. wt. 1 lb.

SP-84 Net 1.95

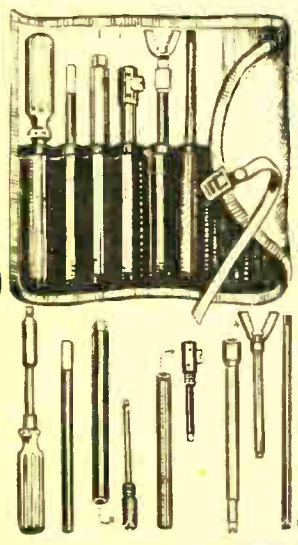

Big Savings ON CERAMICON DISCS

FAMOUS BRAND
1000 V.D.C. WORKING

65% OFF

Brand new highest quality general purpose ceramic disc type condensers at over 65% off list. Stock up now! Available in following sizes.

MMF	MMF	MMF	MMF	MMF	MFD	MFD
5	22	50	150	330	.001	.0027
6.8	25	56	180	390	.0012	.003
10	27	68	200	470	.0015	.0033
12	30	75	220	500	.0018	.004
15	33	82	250	560	.002	.0047
18	39	100	270	680	.0022	.005
20	47	120	300	750	.0025	.0068

Specify Stock No. C401 and capacity.

Lots of 10 **84¢**

Singly, each **9¢**

50 PIECE T.V. KNOB KIT

• A GREAT VALUE

• LESS THAN 4¢ EACH

Just a few of these knobs are worth more than the price of the entire kit! Selection contains 50 assorted TV knobs including such types as channel selector, fine tuning, volume, etc. Useful and attractive. Many with gold lettering or gold inserts. Shpg. Wt. 3 lbs.

KI-45 **1.95**

MASTER SERVICE KIT

175 PIECE KIT

- 100 RMA Color Coded Insulated Resistors
- 25 BY-PASS Condensers
- 25 CERAMICONS
- 25 MICAS

with **4 STEEL MULTI-Drawers**

4.95 ea.

The handiest Kit for the Service Shop or Experimenteer. THIS 175 PIECE KIT contains 100 insulated R.M.A. color coded resistors, consisting of 1/2, 1 and 2 Watt resistors; 25 assorted tubular by-pass condensers, of the most popular capacities and voltages; 25 assorted Erie and CRL Ceramicon disc and tubular, all popular capacities and voltages; and 25 Aerovox, Sprague, Cornell-Dubilier, etc. assorted mica condensers. With 4 Multi Metal Drawers, ALL AT A PRICE worth many times our Selling Price of \$4.95. And don't forget Lafayette's Money Back Guarantee.

KI-33—175 Master Kit with 4 Multi Drawers. NET 4.95

FAMOUS MAKE 3 BUTTON TIMER SWITCH

BELOW JOBBERS COST

Another Lafayette Scoop! A radio manufacturer, making clock radios, over-purchased on electric clocks—needed the cash—liked our green-backs, and Lafayette got the deal. Automatically turns on radios, television sets, toasters, coffeemakers, etc.—at any pre-set time within 12 hour period; also tells time. Built-in single-pole switch handles up to 15 amps, 115 volt. Requires 3/2" diameter round hole. Depth behind dial face 2 1/4". UL ap proved. For 105-125V, 60 cycle AC. Shpg. Wt. 1 1/2 lbs.

\$3.95

Stock No. **MS-123**

RCA PM SPEAKERS

QUANTITY LIMITED

Brand new RCA PM speakers for replacement use. Voice coil 3-4 ohms.

4" PM

SK-63 In lots of 3, Ea. **1.05**
Singly, Each **1.15**

5" PM

SK-64 In lots of 3, Ea. **1.10**
Singly, Each **1.20**

RECORD CHANGER MOTOR

95¢

Shaded 2-pole fan-cooled motor with rubber rimmed idler wheel. Operates on 110-120V 60 cycles AC. Shpg. Wt. 3 1/2 lbs.

SP-89 **95¢**

PHONO TIP PLUG AND JACK

79¢

10 PAIR

Single prong shielded plug used extensively for mike or phono pickup, other connections. Phono jack mounts in rear of panel through 3/8" hole and is 1/2" between centers.

KI-49 10 Pair Net .79
MS-167 Plug Only Net ea. .05
MS-168 Jack Only Net. ea. .08

AC LINE CORD

6 ft. AC line cords, fine quality slip cord with sturdy plug.

EL-13 **19¢**

POWER RESISTOR KIT

20 PIECES

Kit of 20 high wattage resistors. Assorted vitreous enamel and cement coated types from 5 to 25 watts. Shpg. Wt. 1 lb.

KI-43 Net **1.49**

VICTOREEN RADIATION COUNTER TUBES

5.45 1B85

Here's a chance to get the most popular tubes used in Geiger Counters at a substantial saving. All brand new, fully guaranteed.

TYPE 1B85: beta-gamma aluminum wall. Active length 2.75"; wall MG-UM=30; operating voltage 900; threshold voltage 800; plateau length 20%; plateau slope per 100V=2%; life=10.9; coaxial base.

Type 1B85 NET **5.45**

1.75 WESTINGHOUSE 417A KLYSTRON

In lots of 3, ea.

Covers frequency range of 2650 to 3330 mc/sec. Can take up to 75 watts input with forced air cooling. Frequency adjustable by means of screw (coarse) and knob (fine). Ratings: Beam V = 1000 at 40 ma. R.F. Power = 400, Filament V = 6.3 v, at 3 amp. Reflector voltage=250.

SP-13—In lots of 3, each NET **1.75**
Singly, each NET **1.95**

BARGAIN SALE!

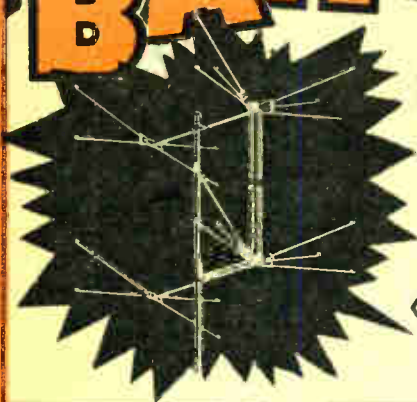

\$4.95
ea.

In Lots of 3

singly, each
\$5.25

← a "Best Buy"

TRY TO BEAT THESE ANTENNA PRICES!

FULL 20 ELEMENT STACKED CONICAL

With Matching Q Bars and High Frequency Stubs

There may be many conicals but there is still only one D-X — champion of its class. The predominating favorite of discriminating service dealers and installers over the years. Made of genuine aircraft aluminum tubing. The best all-around antenna for FRINGE AREAS. Easy to assemble. Works on all channels.

The regular list price of this antenna is \$19.30. Lafayette made a deal with one of the leading antenna manufacturers in the country — and Men, what a deal! Lafayette knocked the price down so low it defies competition. Don't delay! Stock up now. At this price they won't last long. Consists of 2 conical bays and a pair of matching Q bars and high frequency stubs, less mast. Stock No. AN-10, singly, each..... 5.25



SNAP OPEN 20 ELEMENT STACKED CONICAL ALL ALUMINUM NO LOOSE HARDWARE

- FASTEST INSTALLATION!
- HIGHEST QUALITY!
- LOWEST PRICES!
- TOP PERFORMANCE!

The best antenna deal yet for every serviceman, installer, and service dealer. All the most wanted features at the lowest possible prices! No loose hardware! New dipole head locks in elements without tools! Internal aluminum dowel reinforced elements. "Quick-as-a-wink" assembly! Perfect, unbroken electrical continuity from elements thru dipole head. Famous conical design for metropolitan and suburban areas. Two complete conical bays with Q-bars and hi-freq. stubs, less mast. Shpg. wt. 8 lbs. AN-28

\$6.42

NET **6.42** each
each **5.78** in lots of 3

ECONOMY 3 SECTION VHF INDOOR ANTENNA

99¢
ea.

All-channel; all-way orientation. Indoor adjustable antenna, aluminum staffs, mirror finish. Attractive crackle finish base. Completely assembled and ready to use with 300 ohm twin lead. Priced by Lafayette as a loss-leader! Shpg. Wt. 2 1/2 lbs. Stock No. AN-12, singly, each \$1.15



In lots of 6..... 99c

VHF PACKAGE ANTENNA ACCESSORY PACKAGE



2.85

In lots of 3 Complete antenna accessory package. Contains everything you need. Includes 5 ft. steel mast, 1/4" O.D.; all-angle base mount; twining lighting erector; 75 feet of 300 ohm polyethylene twinline; 6 insulated screw eyes; 2 insulated mast standoffs. Complete; nothing else to buy. Stock No. KT-12 Shpg. Wt. 7 lbs. Singly, each special 2.95

UHF ANTENNA ACCESSORY PACKAGE



Complete UHF antenna accessory package. Contains everything you need. Includes 5 ft. steel mast, 1/4" O.D.; all-angle base mount; UHF lighting erector for tubular and open line; 100 ft. of 300 ohm open line; 8 insulated 7/8" screw eyes; 2 insulated mast standoffs. Complete—nothing else to buy. Shpg. wt. 7 lbs. **Special 4.25** KT-21..... Same as above—but with 100 ft. tubular twin lead. KT-22..... **Special 4.95**

ALL ALUMINUM 8 ELEMENT CONICAL

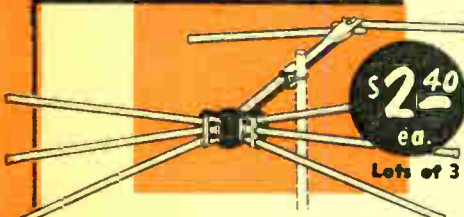

\$2.40
ea.
Lots of 3

Jabbers pay more for this all-aluminum 8 element conical. Full size rugged insulator block. Aircraft aluminum elements and cross arm. Designed for rapid assembly to assure quick, easy installation. Fan front of 6 full length elements for best response of all VHF channels. The best antenna value Lafayette has offered. Just look at the price! Shpg. wt. 4 lbs. AD-11

Singly **2.60** each
Lots of 3 **2.40** each

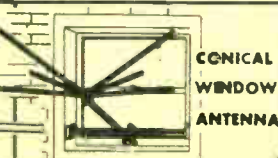

CONICAL WINDOW ANTENNA

Ideal for locations where roof antennas are prohibited. 4 full-sized conical elements, plus 2 high frequency dipoles, deliver powerful all-channel performance. Install simply and swiftly by placing ends of base against window frame and tightening wing nuts. Easily adjustable base spans up to 44 inches to fit most wood or casement window frames. Durably constructed of light weight, weather-resistant, seamless aluminum elements. Direct match to 2, 15.0 or 300 ohm lead-in. Adjustable in all directions for maximum signal pick-up. Shpg. wt. 3 lbs. List \$12.75.

AN-22 NET **4.50**
AN-23—Ext. Bar for 5' wind **1.18**
AN-24—Ext. Bar for 6' wind **1.47**



ALL ALUMINUM CORNER REFLECTOR 3.30

Solid aluminum construction throughout — permanent rust and corrosion resistance. Flip open design for rapid, easy installation. High front-to-back ratio — maximum UHF gain. Extremely rigid design for vibration proof operation. Properly engineered to create necessary dipole — reflector wave length relationship. Shpg. wt. 5 lbs. AN-30 Net **3.30**



ECONOMY UHF CORNER REFLECTOR

2.59

A factory pre-assembled efficient corner reflector at an economy price. Factory preassembled for fast, easy dual U-bolt installation. All welded heavy duty reflector screens. Diamond embossed aluminum elements. Covers all UHF channels 14-83. Shpg. Wt. 3 1/2 lbs. AN27 Net **2.59**

NEW ECONOMY UHF BOW TIE

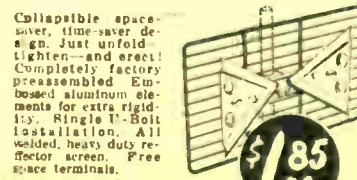

Collapsible space-saver, time-saver design. Just unfold—tighten—and erect! Completely factory preassembled. Embossed aluminum elements for extra rigidity. Single U-Bolt installation. All welded, heavy duty reflector screen. Free space terminals. **\$1.85** ea. AN-26 .NET **1.85**

• ALL CHANNEL ANTENNAS •



Money Back Guarantee

UNCONDITIONAL ABSOLUTE YOU BE THE JUDGE

The confidence of the manufacturer in his product is reflected in this unheard of guarantee. Every all-channel antenna must perform to your satisfaction, or return the antenna within 30 days for a full refund of the purchase price, with no questions asked.

FOR THE FINEST IN PICTURES

- COMBINING THE MOST POWERFUL INDOOR TV ANTENNA EVER DEVELOPED WITH UNMATCHED BEAUTY.
- GUARANTEED TO OUTPERFORM ALL OTHER INDOOR ANTENNAS ON ALL CHANNELS 2-83 BOTH IN COLOR AND BLACK-WHITE.
- GUARANTEED TO ACTUALLY EQUAL ROOF ANTENNA PERFORMANCE IN METROPOLITAN AREAS.
- GUARANTEED TO ELIMINATE OR DRASTICALLY REDUCE ALL GHOSTS IN PRACTICALLY ALL LOCATIONS. UTILIZES A 9 POSITION ORIENTATION SWITCH, NOT JUST AN IMPEDANCE MATCHING SWITCH.

All Channels REMBRANDT antenna utilizes a radically new patented principle. It selectively directs circularly polarized electro-magnetic loops and inductively couples them to resonant dipoles, resulting in the sharpest, strongest signal up to 10 times more powerful than other indoor antennas. Each dipole has brass sections. The 9 position switch has raised luminous materials, and dial face that is clearly viewable in a darkened room. The entire design is tasteful and attractive. Gold finished knob, choice of colors on base. Size of base 1 1/2" W x 5 3/4" D. Unextended dipoles are 18" high. Shpg. Wt. 3 1/2 lbs.

MODEL M-100—Mahogany Finish Base—List 11.95.....	Net, each	9.95
MODEL I-100—Ivory Finish Base—List 11.95.....	Net, each	9.95
In lots of 6, either of above, each.....		8.95

ONE INSTALLATION FOR UHF-VHF-FM RECEPTION

MONEY BACK GUARANTEE

Reg. ~~22.85~~ **UNTIL SEPT 10 ONLY 17.95**

ALL CHANNEL'S "RIVIERA" WORLD'S MOST POWERFUL ULTRA-FRinge VHF—UHF—FM ANTENNA

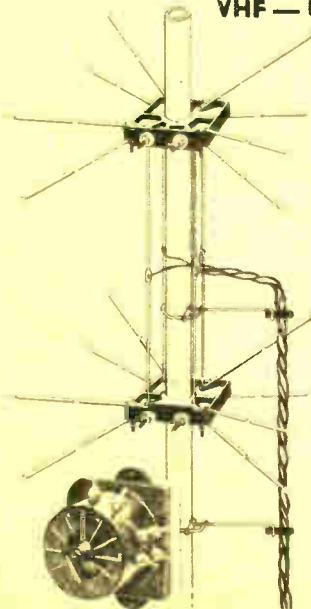

GUARANTEED 200 MILE VHF RECEPTION OR YOUR MONEY BACK

- Receives channel 2-83 from all directions without a rotor
- Broadband UHF-VHF and FM, motorless all direction reception
- All aluminum flip-out assembly

Field tests reception on VHF of up to 200 miles has made possible this unprecedented guarantee. Here is an antenna with one transmission line for all UHF, VHF and FM stations in all directions without the use of a rotor. The nine position selector switch connected at the set electronically rotates antenna beam instantly without physically moving the antenna. Gain on channels 2-6 comparable to 4-bay conicals; on channels 7-13 comparable to stacked 10-element single channel yagis; on 14-83 comparable to bow-tie reflector. 16 1/2" doweled aluminum elements are 60 inches long. Complete with switch, coupler, 45" stacking bars and 2 7/2" angle type mast insulators for Polymicalene line listed below. Shpg. Wt. 10 lbs. **ALL CHANNEL RIVIERA LESS MAST Net 17.95**

THE RIVIERA MUST BE USED WITH THE LOW LOSS LEAD IN WIRE LISTED BELOW

ALL CHANNEL'S MODEL AD2-8 FRINGE AREA ANTENNA

MONEY BACK GUARANTEE

22 Db gain UNTIL SEPT 10 ONLY 13.95

over a tuned dipole

- Receives channel 2-83 from all directions without a rotor

The performance of the AD2-8 is exceeded only by its big brother the Riviera. Following the same basic principles as the Riviera it is designed for the same fine rotorless reception in fringe and near fringe areas. Uses 45" long 3/8" elements. The 9 position switch located at this set gives you a choice of nine antennas, 2 or more types for each direction. Comes complete with two stacked 8 element antenna array, 9 position switch, completely wired stacking harness and automatic impedance matching coupler. Requires all channel lead in wire listed below. Less mast. Shpg. wt. 7 lbs.

MODEL AD2-8—List 36.50 Net **13.95**

ALL CHANNEL LEAD-IN WIRE FOR USE WITH RIVIERA AND AD2-8



Special All-Channel 4-Conductor Matched Impedance Transmission Line. Low-loss mica filled POLYMICALENE insulation and COPPERWELD conductors.

WR-18, per foot 10c per 100 ft. **9.90**

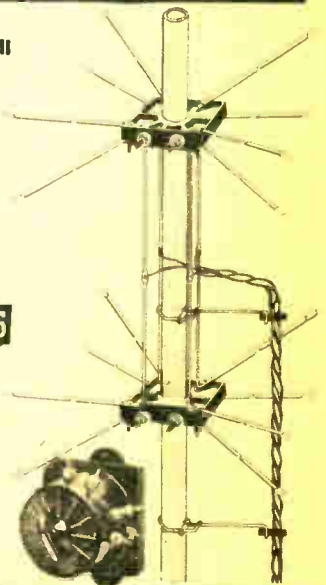

ALL CHANNEL COMPONENT PARTS

TS-229	9 Position Switch	Net 5.93 Ea.
TS-230	Switch to Set Coupler	Net .62 Ea.
TS-231	Stacking Harness	Net 2.87 Ea.

New! SUPER FRINGE AREA ANTENNAS

JFD STAR HELIX

A VHF antenna for both black and white and color. New Hi-Plex folded dipole design transforms low band collector into 3 half wave length antennas that develop highest in-phase current on high band. This results in sustained high signal magnitude on all low and high band channels—plus sharp forward unidirectional response. Consistent flat gain across spectrum, uniform high signal to noise ratio, narrow beam width and close 300 ohm impedance match essential for fidelity in color reception. Gain up to 18 db on high band and to 11 db on low band (over a 1/2 wave reference dipole). Completely preassembled. Just flip elements into place. No tools—no screws. All aluminum. Supplied complete less mast. Shipping weights: SX711—9 lbs., SX711S—18 lbs. Stacked model supplied with high gain stacking transformers.

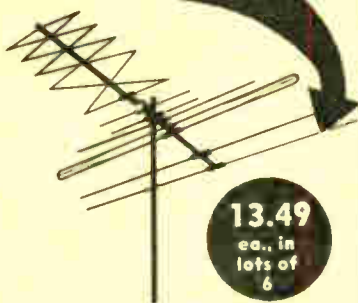

13.49
ea., in
lots of
6

- | | |
|--|------------------|
| SX711—Single Star Helix—List \$25.50 | Net 14.99 |
| In Lots of 6, each..... | 13.49 |
| SX711S—Stacked Star Helix—List \$52.50 | Net 30.87 |
| In Lots of 6, each..... | 27.78 |

JFD FIREBALL ANTENNA

VHF-UHF FRINGE AREA BROAD BAND INLINE

An economically priced broad band array with a sensational 11.5 db gain in a compact assembly that features high directivity, front-to-back and front-to-side rejection of unwanted signals for cross interference—free reception in both color and black and white on all channels. Wide spaced booster and parasitic elements assure maximum pick-up. All aluminum. Fast installation—flip-lock elements. Stacked array has special open-end booster transformer permitting close stacking for maximum high band response and electrical wide stacking for optimum low band. Shpg. Wt. single 5 lbs., stacked 10 lbs.

- | | |
|---------------------------|------------------|
| FB500—Single—List 17.35 | Net 10.20 |
| In Lots of 6, each..... | 9.18 |
| FB500S—Stacked—List 36.65 | Net 21.55 |
| In Lots of 6, each..... | 19.39 |

FINCO F-4 with "FIDELITY PHASING" 27⁰⁵

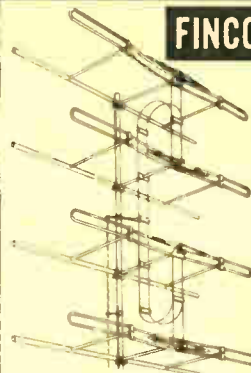

- Super Fringe Area Reception!
- Up To 200 Miles On Both Low And High Band
- Unconditional Warranty!

Latest VHF design — with exclusive "Fidelity Phasing" top performance on both low and high bands — channel 2 thru 13. Extremely high directivity — sensitivity — and color acceptance. Unbelievable reception at distances up to 200 miles from TV station. Employs four driven, low band in-phase folded dipoles and twelve driven, high band in-phase folded elements. Eliminates complicated delicate harnesses—produces in-phase colinear currents. Extremely flat response—engineered for color! Completely preassembled — all aluminum — light weight — rugged construction. Less Mast. Shpg. wt. 13 lbs.

- | | | |
|-----------|------------|------------------|
| FINCO F-4 | List 46.00 | Net 27.05 |
|-----------|------------|------------------|



FINCO GEOMATICS

MODEL B-8 TWIN-DRIVEN

The first broad-band antenna ever to obtain absolute maximum front-to-back ratio for the elimination of venetian blinds, back ghosts, etc. with no sacrifice of gain in either low-band or high-band. Accomplished by twin-driving of TWO FIDELITY PHASED elements; "QUAD-TRI-QUAD" drive — true quadrature twin-drive on low-band and tri-quadrature twin-drive on high-band; and "INTERLEAVED ELEMENTS." These are added to FIDELITY PHASING — combining the proved superiority of driven folded dipole impedance matching on low-band with the acknowledged extra-high gain of three-element colinear operation on high-band. Multiple reflectors and directors, including combination and colinear elements, also, increase the sharp directivity. Oversize, extra-heavy gauge square aluminum tube boom. Shipping Weight: 9 1/2 lbs. List Price: **37.50** Net **22.05**

- | | |
|---|---|
| MODEL NO. 5-830: STACKING KIT favors low band. Shipping Weight 1/2 lb. | List Price: 2.00 Net 1.18 |
| MODEL No. 5-860: STACKING KIT favors high band. Shipping Weight 3/4 lb. | List Price: 3.00 Net 1.76 |

MODEL B-5

MAXIMUM FRINGE AREA
The absolute ultimate in broad-band, high-gain VHF Antenna design — Oversize extra heavy gauge square aluminum tube boom. All element brackets are of "Box Girder" aluminum construction. Exclusive "FIDELITY PHASING" combines the proved superiority of driven folded dipole impedance matching on low band together with the acknowledged extra high gain of three element colinear operation on high band. Multiple low band reflectors and directors, high band colinear reflectors and directors, as well as combination elements, combine with "FIDELITY PHASING" TO PRODUCE FOR THE FIRST TIME ACROSS THE FULL VHF BAND (ch. 2-13), the Ultra High Gain and sensitive directivity previously found only in twelve (12) element Yagis cut to single channel. This makes possible reception and picture clarity heretofore considered impossible to obtain in maximum fringe areas up to 200 miles or more. Shipping Weight: 9 1/2 lbs. List: **\$32.00** Net: **\$18.82**
MODEL NO. 5-5: STACKING KIT TO STACK TWO OF MODEL B-5 Shipping Weight: 3/4 lb. List Price **\$2.50** Net **\$1.47**

NEW! JFD POWER HELIX

A new concept in driven element design. Extremely high front-to-back ratios — up to 27 db minimize co-channel and adjacent channel interference. Poly-phase triple resonator flat dipole system steps up gain across entire VHF spectrum. Helical section of non-linear additive collectors — each separately tuned for gain and directivity. Uniformly high signal-to-noise ratio — narrow beam width — uniform 300 ohm impedance match. All aluminum — completely pre-assembled. Hi-tension elements flip into place. Shpg. wt., 6 lbs.

- | | | |
|---------|--------------------------------|-----------------------|
| PX-911 | List 32.50 | Net Ea. 19.11 |
| | In lots of 6, Each, Net | 17.20 |
| PX-911S | Stacked Power Helix List 67.50 | Net. Ea. 39.59 |
| | In lots of 6, Each, Net | 35.93 |

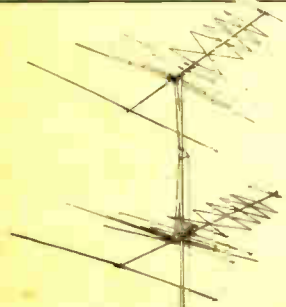

JFD DOUBLE DRIVE UHF TWIN CORNER REFLECTOR

Designed for supersensitive deep fringe performance. Features twin angled multi-grid reflectors to trap 100% of the signal and bounce it back into the curved in-line bow-tie dipoles. "Double Drive" gives sharp directivity with high front-to-back and front-to-side ratios to eliminate co-channel and adjacent channel interference. Completely preassembled, entire array flips open. Durable all-welded construction resists hurricane winds. Triply reinforced grids. Grids, bowties, brackets and hardware are cadmium and clear Iridite plated for corrosion protection. Less Mast—Shpg. Wt. 6 lbs. UHF-2411—List 11.65.....Net **6.85**
In Lots of 6, each.....**6.16**

6.85

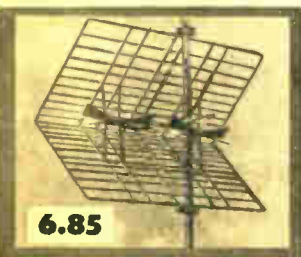

JFD "DO DO"

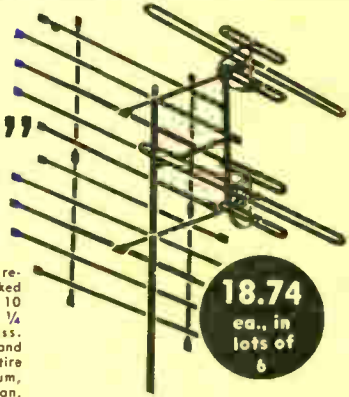

18.74
ea., in
lots of
6

The "DO-DO" is a remote fringe VHF stacked array of 6 dipoles and 10 reflector elements with 1/4 wave jumper harness. Very sharply directive and high gain over entire VHF band. All aluminum, rust proof construction. Partially pre-assembled for speedy installation. Shpg. Wt. 14 lbs. Less mast.

- | | |
|-----------------------------|------------------|
| JFD C3025 DO-DO, List 35.40 | Net 20.82 |
| In Lots of 6, each..... | 18.74 |

SUPER "DO-DO"

- | | |
|---|------------------|
| Similar to above but with 15 reflector elements and 1/2 wave jumper harness for real deep fringe areas. 17 lbs. | |
| JFD SC3025 — Super DO-DO, List 47.25 | Net 27.78 |
| In Lots of 6, each..... | 25.00 |

LAFAYETTE Is Headquarters For

TV ACCESSORIES

NEW ALLIANCE TENNA ROTORS



Faster — Smoother — Better than ever! Redesigned and restyled to provide the most in efficiency, durability and decorator styling. Rotation speed has been boosted to a full 2 r.p.m. Fastest change from station to station. New **MAGNETIC BRAKE** affords instantaneous stop. No drifting! New guy wire attachment has been provided on the clamp plate. Full 360° rotation. Factory lubricated for life.

MODEL U-98 Fully automatic! Just set control knob — antenna rotates to desired position and stops automatically. Indicator shows position of antenna. Shpg. wt. 12 lbs.
U-98 List \$ 39.95

MODEL T-12 Manually operated with direction indicator. Needle indicates position of antenna on control panel.
T-12 List \$ 29.95

MODEL K-22 Economy model — 1 r.p.m. motor. Full 360° rotation, gear brake. Start-stop-reverse switch. WRh remote control, less direction indicator.
K-22 List \$ 19.95

THRUST BEARING BRACKET Increases capacity of Tenna Rotors up to 300 lbs. Shpg. wt. 3 lbs.
TBB List \$4.95

CONDUCTOR FLAT CABLE for above. NET 2.81

WR-24 Per Foot 30

Thompson Products SUPEROTOR



- FULLY AUTOMATIC
- SILENT-ELECTRONIC CONTROL
- VERNIER PRECISION TUNING

Completely electronic — silent — automatic. Electronic tuning rotates antenna smoothly to exact position chosen — not in steps of 6° to 10° as most automatics do. Gives high degree of accuracy necessary for Fringe — UHF — and Color reception. Dial automatically illuminated during rotation. Heavy duty rotor has easily detached power drive unit. Rugged tubular support takes masts from 1" to 1 1/2". Unit mounts on masts up to 2" in diameter. Built in 3-jaw most aligner — built in vertical and horizontal thrust bearings. Rotates through 365° at 1 RPM — instantly reversible. Unique mount for most or chimney mounting. Shpg. wt. 15 lbs.
Superotor A-100 List \$4.95 Net 33.60
In Lots of 6, Each Net 32.19

NEW "SKY-LOK" MAST

- Interlock Sections—won't pull out!
- Hot Dip Zinc Galvanized—inside and out!
- Husky thumb bolts lock section automatically at any weight!
- Bell shaped bottoms and curled top interlock snugly.
- Completely preassembled—simply add matched guy rings.
- Complete with all guy rings, clamps and hardware necessary for installation.

Heavy Duty 16 Gauge .067 Wall	
TM 12-20 (20 ft.)	Base Sec. 10 ft. 1 1/4" O.D. Top Sec. 10 ft. 1 1/4" O.D. 6.53
TM 123-30 (30 ft.)	Base Sec. 10 ft. 1 1/4" O.D. Cent. Sec. 10 ft. 1 1/4" O.D. Top Sec. 10 ft. 1 1/4" O.D. 10.94
TM 1234-40 (40 ft.)	Base Sec. 10 ft. 2" O.D. Cent. Sec. 10 ft. 1 1/4" O.D. Top Sec. 10 ft. 1 1/4" O.D. 15.67
TM 12346-50 (50 ft.)	Base Sec. 10 ft. 2 1/4" O.D. Cent. Sec. 10 ft. 2" O.D. Top Sec. 10 ft. 1 1/4" O.D. 20.43

ALL ANGLE BASE AND ROOF MOUNT

ZUB2 1/2. All Angle Base and Roof Mount Most popular swivel base mount in use today. Works on any surface. — But stand, rack or wall. Heavy gauge weatherproofed steel. Takes any mast up to 2 1/4" O.D. Complete with hardware.
T8-37 List 3.05 NET 1.79



ROTOR QUEEN
13.30
R-55
M-55

Here is a rotor that is engineered with outstanding quality features but without any fancy dood-dad to add to cost. Weather sealed all aluminum housing with maximum mast support—antenna sets 3" into drive unit. Full 370° rotation in each direction with instant braking for pinpoint accuracy. Direct gear drive for high torque—no worm gears. Lifetime allite bronze side thrust bearing, rustproof parts. Guy wire supports and Ragnolla type base for easy installation. Control unit of mahogany polystyrene only 3 1/4" x 3 1/4" x 3 1/4". Finger-tilt control. Shpg. wt. 7 lbs.
RMS R-55 Rotor Net 13.30
3-wire cable for above per hundred ft. 1.50
WR-49 per ft. .02

ACCESSORIES
Thrust bearing for R-55 and M-55 Net 2.91
Directional Indicator Model. Same high quality. Low cost features as above — Plus a Directional Master Indicator to pinpoint direction antenna is facing. Shpg. Wt. 7 lbs. RMS M-55 NET 17.30
4 Cond. cable for above WR-24 per ft. .03



BLONDER-TONGUE VHF BOOSTER
27.74

Blonder-Tongue Model HA-3 is a fully automatic booster. Powerful, broadband, 3-tube, 3-stage cascade push-pull circuit. Provides signal gain of 16 db on all 12 TV VHF channels. Goes on and off automatically with the TV receiver by means of an automatic thermal relay. Employs three 6J6 low-noise dual-triode tubes. Excellent signal-to-noise ratio. For 300 ohm line. In attractive mahogany finish hamper-tone metal cabinet, 5" x 5 1/2" x 4". Complete with instructions. For operation from 105-120 volts, 50-60 cycles AC. Shpg. wt. 4 lbs.
MODEL HA-3 BOOSTER. NET 27.74
List 47.00



Blonder-Tongue UHF Converter
The only converter for "Class A" signal areas with these exclusive features. Tuned input tracks with oscillator, rejects spurious signals, suppresses oscillator radiation. Precise impedance match gives maximum signal conversion—no line ghosts—no picture smear. Drift-free performance is achieved by use of a thermally compensated oscillator circuit. One knob tuning; no VHF channel switching; output on channel 4, 5, or 6. Complete with tubes and instructions. Shpg. Wt. 4 lbs.
Model 99—List \$19.95.....Net 14.66

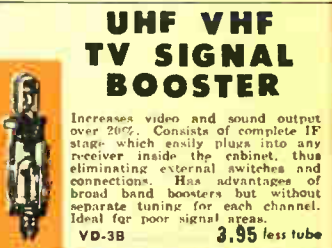

UHF VHF TV SIGNAL BOOSTER
Increases video and sound output over 200%. Consists of complete IF stage which easily plugs into any receiver inside the cabinet, thus eliminating external switches and connections. Has advantages of bond boosters but without separate tuning for each channel. Ideal for poor signal areas.
VD-3B 3.95 less tube



JFD INTERFERENCE ELIMINATOR
2.65
CAT. NO. HPSO

Gets rid of all interference below 50 megs — ham — diathermy — industrial — etc. No effect on signal strength. No ground needed. Mounts on back of set. For 300 ohm line. Shpg. Wt., 1/2 lb.
TS-235 NP-50 List 4.50 Net Each 2.65



JFD MATCHING TRANSFORMER
2.65

Matches any 72 ohm TV set to any 300 ohm antenna. Permits use of noise free 72 ohm coax line with 300 ohm antenna. Sealed in col-plast for climate proof permanency. Transfers maximum signal strength. Shpg. wt., 1/2 lbs.
TS-236 AC-50 List 3.50 Net Eo. 2.06

JFD OUTDOOR SET COUPLERS

- NO MESSY INDOOR WIRING
- NO LONG "LOSSY" LEADS

New outdoor set couplers — encapsulated in col-plast for maximum weather proofing. Minimum insertion loss due to network of bifilar coils. Optimum isolation and impedance match between sets. All elements sealed in air tight case mounted in a butyrate housing.
Shpg. wt., 1/2 lb

	List	Net
TS-232 AC 40 2 set 300 ohm	3.50	2.06
TS-233 AC-60 3 set 300 ohm	4.00	2.35
TS-234 AC-70 4 set 300 ohm	4.50	2.65

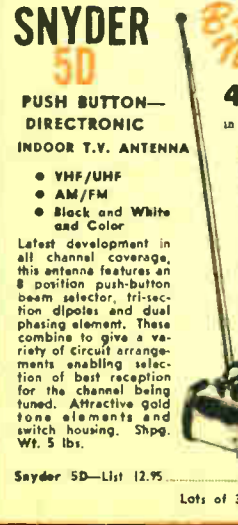

SNYDER 50
4.98
12 lots of 3

PUSH BUTTON—DIRECTRONIC INDOOR T.V. ANTENNA

- VHF/UHF
- AM/FM
- Black and White and Color

Latest development in all channel coverage, this antenna features an 8 position push-button beam selector, fringed dipoles and dual phasing element. These combine to give a variety of circuit arrangements enabling selection of best reception for the channel being tuned. Attractive gold tone elements and switch housing. Shpg. Wt. 5 lbs.
Snyder 5D—List 12.95
Lots of 3, each 4.98

ALL CHANNEL DELTA BEAM

ALL CHANNEL DELTA BEAM
4.90
VHF
UHF
FM

Combines principles of Helix coil, folded dipole, straight dipole and Delta match transformer. 6-position switch matches line impedance and resonates antenna to match receiver input circuit. Covers all channels 2-83. Half ball swivel on clear plastic base to beam antenna in best direction. Mounted on rubber. Shpg. Wt. 4 lbs. List 9.95.
DELTA BEAM Antenna.....Net 4.90

JFD NEW DIALAMATIC VHF UHF COLOR TENNA

JFD NEW DIALAMATIC VHF UHF COLOR TENNA
3.43

First indoor antenna designed with color TV in mind. Futuristic design C-position recessed switch electronically phases special channel resonant or for maximum fullness—on VHF—on UHF —in full fidelity color. Velvet action, 3 section telescoping polished and lacquered brass dipoles. Heavy weighted "Tip-proof" base with selector switch completely recessed. Harmonizes tastefully with interiors of any decor. Three decorator colors to choose from—Mahogany, Ebony and Ivory. Specify color. Shpg. Wt. 3 lbs.
TA-147—List 9.95—Net 3.43

SNYDER Directronic PORTABLE ANTENNA 3D

SNYDER 3D
2.98
List 7.95 NET 2.98

Newest indoor antenna Features the famous Snyder Directronic 6-position Beam Selector Switch! Gives the clearest picture on every channel—instantly—no waiting! Covers all channels from 2 to 83! New cross-phasing element gives high variety of circuit arrangements. Aids in impedance matching, ghost elimination and orientation. Two 3-section gold tone brass shafts. Brass plated phasing bar. Shpg. wt. 2 1/2 lbs.

MORE LAFAYETTE SCOOPS!

BIG SAVINGS

SCREW-EYE INSULATORS 98¢

3/4" wood screw type with genuine polyethylene universal insert for T.V. line.

BOX OF 50

5.95



TV TUBE "BRITENER"

.79 each
In lots of 10

A startling new discovery in the TV field! Absolutely no tools or soldering needed for installing this handy inexpensive tube rejuvenator. You simply attach two plugs as directed in the instructions. For magnetic tubes and PARALLEL CIRCUITS only. Restores brightness contrast. Stock No. MS-12 in lots of 10



.79 each
singly **.89**

UNIVERSAL TV TUBE BRIGHTENER

1.29 ea.
In Lots of 6
Singly **1.39**

Restores brightness to dim TV picture tubes. Operates on all types—magnetic or electrostatic—and in all circuits—parallel or series. TS-170—In lots of 6 each **1.29** singly **1.39** each **1.39**



OCTAL TEST ADAPTER

1.03



Test Adapter does the trick. Just replace a tube with the Test Adapter. Plug Tube into Test Adapter. Press all socket connections are tight—within instant reach of your test probe. Just one job pays for this Test Adapter. For 8 Pin Octal Tubes.

MS-85 **Net 1.03**

UNIVERSAL YOKE EXTENSION HARNESS

Used in conjunction with the tube harness and the anode harness to facilitate servicing. Provides extension from yoke and coil assembly to chassis. For any make or model using octal plug and sockets as extension. TS-137 **Net 1.32**



UNIVERSAL TV & CRT EXTENSION CORD

Permits testing of picture tube outside of chassis. Fits any duodecyl based tube. 5 color coded leads—10" long. Male and female bakelite sections with full socket and 6 leads for electrostatic as well as magnetic tubes. TS-138 Shpg. wt. 1 lb. **NET 1.26**

PEAK ROOF MOUNT

A heavy gauge steel peak roof mount. Heavily plated to resist corrosion. Will accommodate masts up to 2" in diameter. Fully adjustable can be easily rotated. Complete with all necessary hardware. Shpg. wt. 5 lbs. Stock No. TS-41 **1.32** Lot of 6, ea. **1.47** Singly, ea.



NEW UNIVERSAL STANDOFF INSULATORS

Latest polyethylene insert will accommodate twin-lead, open line, hollow and tubular lines, round lines, oval lines, double lines, etc.

SCREW-FAST STANDOFF

First choice for fast secure anchoring. TL-10 — 3 1/2" 3¢ ea. 10 for 25¢ TL-11 — 5" 5¢ ea. 10 for 45¢ TL-12 — 7 1/2" 6¢ ea. 10 for 54¢



DRIVE-IN STANDOFF

Made of galvanized steel TL-20 — 3 1/2" 5¢ ea. 10 for 45¢



ADJUSTABLE STRAP-TYPE STANDOFF

Fits any size mast TL-16 — 3 1/2" 11¢ ea. 10 for 79¢ TL-17 — 7 1/2" 15¢ ea. 10 for 99¢



"CLIP-ON" STANDOFF

Attach to mast instantly—"Click" and they're on. 3 1/2" long. TL-22 — for 1 1/4" Mast 6¢ ea. 10 for 54¢



3 1/2" WALL BRACKET

One of the most popular and practical antenna mounts. Securely grips all masts from 1" to 1 1/2" O.D. Made of rust-resistant steel. Supplied with hardware. Shpg. wt. 2 lbs. Stock No. MS-13, singly, ea. 49¢ In lots of 6 ea. 39¢

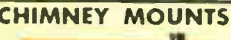

CHIMNEY MOUNTS

Can be erected in minutes; without special tools or drilling. Adjustable, two-section design permits unlimited spacing between brackets for maximum support of masts 1/2" to 1 1/2" O.D. Complete with two 12-ft. lengths of 3/4" galvanized steel bands and hardware. Shpg. wt. 3 lbs. Stock No. TS-82. Lots of 3, Each **.99** Singly, Each **1.15**

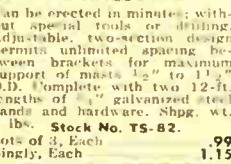

QUICK CLIP

10 FOR 99¢

This clip provides a simple, speedy method of attaching antenna lead-in to TV set. Can be instantly connected or disconnected. Can't short out. Works in any position. Shpg. Wt. 4 oz. Stock No. TS-10, Net, ea. **12¢** Lots of 10 **99¢**



PERMA POWER TV VOLTAGE REGULATOR

Engineered to insure maximum performance of any TV set. Retains full height and width when low line voltage distorts picture. Reduces tube failures—increases set sensitivity. Handles full 300 watts—up 10 volts or down 10 volts. Turns on or off with set or appliance. 10 second installation.

TR-20 **Net 3.97**
TR-20 **NET 3.97**



DUO-DECAL TV SOCKET

Laminated Duo-Decal Television Socket with plastic cover for complete insulation. Pins Nos. 1, 2, 10, 11 and 12 wired for quick installation. For use with standard Cathode Ray tubes. Stock No. MS-19, Each **25¢** In lots of 6 **each 22¢**

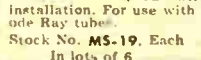

BAKELITE KNIFE SWITCH

Quantity limited. Excellent for TV antenna switching. Heavy metal parts mounted on bakelite base. Double pole, double throw, 2 1/2" long. TS-100 **33¢**

INTERLOCK LINE CORD-A

Replacement cord for RCA, Philco, GE, Admiral, and others. It has regular mold-ered plug on one end and special rubber plug on the other to fit TV sets. Underwriter's Laboratories approved. A very handy thing to have in your service kit or on the workbench. TS-105—6 ft. brown cord **29¢**

INTERLOCK LINE SOCKET-B

Conventional male interlock socket. Standard type used on all television receivers. Heavily plated contact pins. 1 1/2" mounting centers. TS-106 **9¢**

TWIN LEAD SPLICE

Speeds splicing without need for twisting or soldering. TS-104 **11¢** 10 for **99¢**

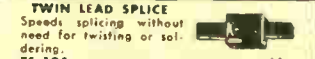

2-SET COUPLER

Uses one antenna for two sets. Compact electronic set coupler assures performance of two TV sets on one installation. Easy to connect. Nothing to go wrong. MS-18 **each 90¢** In lots of 3 **each 85¢**



RCA 240A1 TV SET COUPLER

Operates two or more sets from a single antenna. Easy to install—self-contained wood screw. There's no need to cut or splice the lead because connections are automatically made when the screw caps are tightened. Installation is a matter of minutes. RCA 240A1 **Net 1.15**



PRINTED CIRCUIT 2-SET COUPLER

Provides perfect matching of both sets to any antenna. Actually improves reception where poor match exists. Permits operation of FM radio and TV set from one antenna. Uses wound section of copper ribbon on fiberglass. Easy to install. Operates 2 TV or FM sets. Effectively isolates each set. Shpg. wt., 6 oz. TS-228 **Net Ea. 1.98**



JUMBO UHF-VHF LIGHTNING ARRESTOR

TAKES TWIN, TUBULAR AND OPEN LINE • LESS THAN JOBBER COST • U.L. APPROVED
A real giant sized arrestor to afford maximum protection. JUMBO UHF-VHF LIGHTNING ARRESTOR and static charge eliminator for twin, tubular and open line transmission wires. Cobalt blue porcelain base. Supplied with strap for mast mounting and with screws for flat mounting. Also has ground strap and 4 ft. of aluminum ground wire. U.L. approved. Lot of 10 **TS-175** — Lots of 10, ea. **39¢** Singly, ea. **49¢**



MOUNTING ACCESSORIES

Leg screw expansion shield. 100% rust proof. Stock No. TS-50 **NET .09** ea., 10 for **.81**
Leg bolts. 1/4" diam. shank. 1/2" long. Stock No. TS-51 **NET .04** ea., 10 for **.36**
Star drill. 1/2" x 8" for drilling in concrete, brick or stone. Stock No. TS-52 **NET .49** ea.

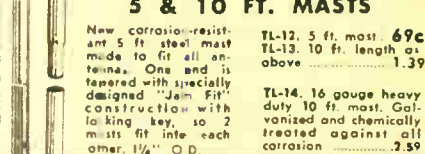
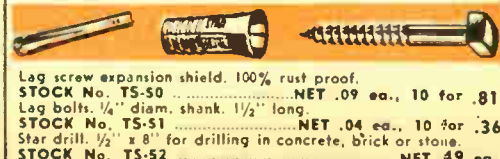

5 & 10 FT. MASTS

New corrosion-resistant 5 ft steel mast made to fit all antennas. One end is tapered with specially designed "Join Fit" construction with locking key, so 2 masts fit into each other. 1 1/2" O.D. TL-12, 5 ft. mast **69¢** TL-13, 10 ft. length above **1.39** TL-14, 16 gauge heavy duty 10 ft. mast. Galvanized and chemically treated against all corrosion **2.59**

UNIVERSAL EBY TV TESTING KIT

Makes possible testing sets with picture tube electrically connected in circuit, but removed from chassis. Reduces danger of contact with high voltage terminals and tube breakage. Consists of anode extension harness, yoke extension harness, tube socket extension harness and sturdy plastic carrying case. CRY EXTENSION is for both ELECTROSTATIC and MAGNETIC tubes. TS-91 Shpg. wt. 2 lbs. **NET 3.53**



RMS-BM-25 CAST ALUMINUM BASE MOUNT

Rugged cast base mount supplied in two sizes to accommodate all commonly used masts. Swivel-type mast connection permits swinging up mast after it is assembled to the base and giving accessories are installed. Base mounts to all surfaces but is particularly ideal as a flat mounting. Takes all masts up to 2 1/2" Shpg. Wt. 3 lbs. List **\$3.88** TS-92—Lots of 6, each **79¢** singly, each **89¢**



NO RUST BARGAIN MOUNT

The ideal chimney mount for life-long satisfactory service under the most severe conditions. Hot dip galvanized steel "Y" mount. Two 12 ft. stainless steel straps and stainless steel seals. And at Lafayette's bargain prices. Shpg. wt. 4 lbs. TS-90, Ea. 2.08 Lot of 3, ea. 1.88

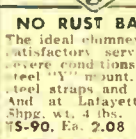

PENN SUPER DUTY MOUNT

A super-heavy pair of chimney mounts made of aluminum alloy. Extra strong and durable. Will withstand the most severe weather conditions. Two 12 ft stainless steel straps and stainless steel seals. Six aluminum corner brackets to protect chimney bricks. The most ideal and permanent installation for those who want quality and durability. Will hold masts up to 2" O.D. Shpg. wt. 5 lbs. TS-91, Ea. 5.20. Lots of 3, ea. 4.68



6" WALL BRACKET

Heavy gauge aluminum. Carriage bolts throughout. Full thread hex head lag screws. Masts just "snap-in" for easy handling. Tripod legs. TS-156 **Per Pair 1.62**



ALUMINUM MAST

10-foot durable aluminum mast. 1 1/2" gauge—heavy wall—high tensile strength. Rust and corrosion proof. TL-17, Each **2.59** Lots of 3, each **2.35**



ALUMINUM GUY WIRE

Rust-proof—specially tempered—7/16" gauge strands—wires—high tensile aluminum alloy. Breaking strength 500 lbs. WR-33—Per 100 ft. Roll **1.79** Lots of 5, ea. **1.69**

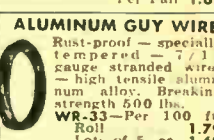

STAND-OFF INSULATORS

Aluminum 3/4" Screw Eye Standoff. TL-24, Ea. 4¢. Lots of 10, ea. 3/3¢ Stainless Steel 3/4" Adjustable Standoff TL-25, Ea. 9¢. Lots of 10, ea. 8/3¢

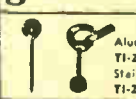

WALL GRIPS

Hollow Wall Screw Anchors
A quick positive wall anchor. Ribbed wings for positive stop. Holds at "knees" allow expansion with less screwdriver torque. No marring of walls. 2 1/2" long. 3/8" body. 5/8" sleeve. With 10-24 screw. TS-207—Net **12¢** Lots of 10, **95¢**



MORE LAFAYETTE SCOOOPS!

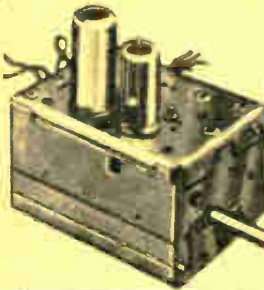

7.25
ea.
In lots
of 3
single, each
7.95

G.I. VHF CASCODE TUNER

TURRET TYPE COMPLETE 6BK7A AND 6J6 TUBES

Brand new turret type complete front and VHF tuner with snap out type channel strips. Used in thousands of Sylvania, Westinghouse and other leading set manufacturers. Has extra 13th position for insertion of VHF strip if needed. For 42 MC sets. Shpg. Wt. 5 lbs. TL-30..... Net **7.95**

QUANTITY LIMITED



CHANNEL MASTER SINGLE CHANNEL T.V. BOOSTER

For areas that have a problem with one particular TV channel, these units are ideal. Cascode type circuit with 6BQ7 tube and selenium rectifier gives exceptionally high gain (12x or 22 db on low band, 8 1/2x or 18.6db on high band). Extremely low noise figure of 4.5 db on low and 6.5 db on high. Uses high Q double tuned transformers specially wound for the specific channel. Undoubtedly the finest single channel booster made. Simple installation. Booster plugs into wall, set plugs into booster. Completely self powered. Has connections for 300 and 72 ohm line, by-pass switch to cut booster out of circuit and thermal-relay that turns booster on with T.V. set. Attractive gray metal case. Hinges to mount on back of set if desired. Size 4 1/2" W x 5 1/2" H x 2 1/2" D. Shpg. Wt. 5 lbs. Available only for channels 11, 12.

QUANTITY LIMITED!

CHANNEL MASTER BOOSTER—SPECIFY CHANNEL..... 4.95

WESTINGHOUSE UHF "MATCHBOX" CONVERTERS

- WITH 6AF4 TUBE AND IN82 DIODE
- 5 UNITS COVER ALL CHANNELS

For LESS than the price of the TUBE! Designed to plug into many Westinghouse 41mc TV sets, the matchbox converter consists of 2 lumped-constant preselection circuits, a 6AF4 local oscillator, IN82 crystal mixer, and tuned output. 5 units cover all channels 14-82. Each unit marked for channel at which it is peaked, but may be varied by tuning wheel to cover ranges listed below. Tuning wheel operates tiny variable condenser. Power supplied by set. In metal can 3 1/4" x 1 1/4" (to base of tube). Complete with 6AF4 tube and tube shield. Shpg. Wt. 1/2 lb.

- TS-195—covers channels 14-29
- TS-197—covers channels 28-43
- TS-198—covers channels 43-58
- TS-199—covers channels 58-73
- TS-192—covers channels 73-83

YOUR COST ANY TYPE

1.59

QUANTITY LIMITED

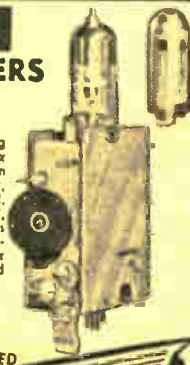

WESTINGHOUSE H803 ALL CHANNEL UHF TV TUNER

- Complete with 6J6 and IN82 Diode

The Westinghouse All Channel UHF TV Tuner covers all UHF channels 14-82. Contains an oscillator and mixer circuit, converts the UHF signal to IF frequency of TV set (center IF 44mc) to feed into a VHF tuner where desired to make a combined VHF-UHF set. Bracket and dial scale supplied to fit thousands of Westinghouse sets for a custom installation, but tuner itself may be used for general UHF applications, the basis of a UHF converter, etc. Individually boxed with complete installation, service notes and technical data. Basic tuner including drum size 5/4" H x 6 1/2" L x 2 1/2" W. Shpg. Wt. 6 lbs.

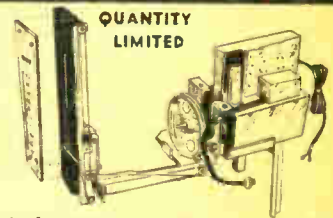

QUANTITY LIMITED

TL-27..... In lots of 3, each **4.45**
Singly..... **4.95**

TV REMOTE CONTROL

18.75



The Controlmaster is a remote control that turns the set on or off, controls the volume, selects the channel, and operates the contrast control—all at a distance from the set and all from a small handisized control unit. A simple powerful solenoid operates the tuner. Easy to install. Comes complete with 25 ft. cable. Designed only for sets using the Standard Coil Tuners. Illustrated as it appears mounted on your tuner. Shpg. Wt. 5 lbs.

TL-23.....

Net **18.75**

WHEELER SOUND-POWERED PHONE

Ideal for TV Installation

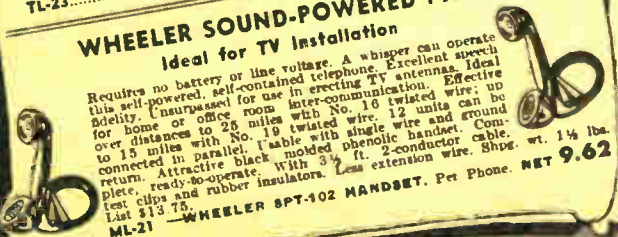

Requires no battery or line voltage. A whisper can operate this self-powered, self-contained telephone. Excellent speech fidelity. Unsurpassed for use in erecting TV antennas. Ideal for home or office room. Later-communication. Effective over distances to 25 miles with No. 16 twisted wire; up to 15 miles with No. 19 twisted wire and ground connected in parallel. Cable with single wire and ground. Attractive black molded phenolic handset. Complete, ready-to-operate. With 3 1/2 ft. 2-conductor cable, test clips and rubber insulators. Less extension wire. Shpg. Wt. 1 1/4 lbs. List \$13.75.

ML-21—WHEELER SPT-102 HANDBET. Per Phone. NET **9.62**

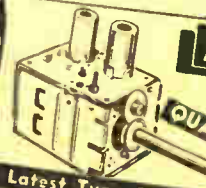

A LAFAYETTE SPECIAL AT THIS LOW PRICE SARKES TARZIAN VHF TUNER

QUANTITY LIMITED

5.45

Latest Type Complete With 2 Tubes
Brand new—covers entire VHF spectrum. It is an exact duplicate of thousands now in use in many chassis including the Sylvania 510 and 520 series. Has 7" long concentric shafts. Excellent gain, noise factor, image and I.F. rejection. For 40 mc IF systems. Complete with 6BC5 and 6X8 tubes and shields. Shpg. Wt. 4 lbs. Worth 3 times the price!

TL-24—In lots of 3 each

Singly each

5.45
5.95

MALLORY INDUCTUNERS

1.59



QUANTITY LIMITED

VHF INDUCTUNER

3 Gang Mallory inductuner for VHF and FM. Provides noise free, continuous tuning in TV and FM receivers and boosters. Tunes 52 to 216 Mc. Eliminates need for band switches—plug in coils—turret at-TV Tuner or booster—FM tuner or booster. Original list \$15.00. Brand new and guaranteed. 4 1/4" x 2 x 2 1/4" overall. Shpg. Wt. 4 lbs.

TL-22.....

Net **1.59**

1.49



QUANTITY LIMITED

UHF INDUCTUNER

A fine Mallory 3 gang UHF Inductuner. Tunes 470 to 890 Mc. Three section inductuner assures accurate, noise free tuning. Complete shielding between sections. Basic unit for tuner-converter—booster. Original list price of \$15.00. All brand new and guaranteed. Shpg. Wt. 2 lbs.

TL-20.....

Net **1.49**

★ STAR VALUES in RCA & STANDARD COIL TUNERS

TYPE XM-752 SOUND TAKE-OFF COIL



For use with Cascade Tuner for T.V. Sets having separate video, and sound I.F.'s. Shpg. wt., 2 oz. XM-752 Net 1.12

THE STANDARD CASCODE TUNER

tops 'em all!

Latest 12 channel VHF turret type cascode tuners made by Standard Coil — the tuner that has been used in more TV sets than any other. These are latest production, brand new and are complete with tubes, parallel heater type. Shafts may be cut if desired. Shpg. wt., 4 lbs.

21 MC CASCODE TUNERS

Complete with 6J6 and 6BQ7A tubes.

TL-11 In lots of 3, Each **13.25**
Singly, Each **13.75**

41 MC CASCODE TUNERS

Complete with 6AT8 and 6BQ7A tubes.

TL-18 In lots of 3, Each **14.25**
Singly, Each **14.95**

13.25

Each
In lots of 3

Singly
13.75
Each



QUANTITY LIMITED

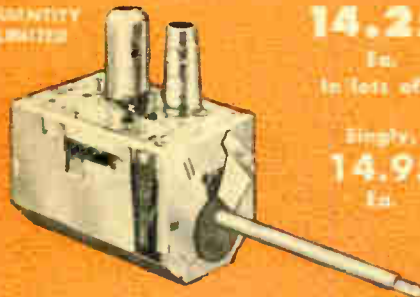

14.25

Each
In lots of 3

Singly
14.95
Each

THESE TUNERS LIST AT UP TO \$50.00 EACH! STOCK UP WHILE THEY LAST

NEW STANDARD COIL CASCODE AND PENTODE SERIES — STRING TUNERS

There is already a big replacement market for these tuners and its growing fast. A high percentage of the sets made in the last 2 years used the new series string tubes and most of the current production uses them. Only a series-string tuner will replace them. You'll pay up to 30.00 dealer net for many of these, so stock up now! All tuners are brand new, complete with tubes. The CASCODE tuners have one 5AT8 and one 4BQ7A tube; the pentode have one 5AT8 and one 3BC5. Both are for 41 MC circuits and cover all 12 VHF channels. They are exact duplicates for the sets listed below, but of course, shafts can be cut to fit other makes and models. Shpg. wt., 4 lbs.

STOCK NO.	SET MFR.	MFR. PART NO.	SHAFT LENGTH	TUBES	CIRCUIT
TL-32	EMERSON	470823	5 3/4"	5AT8-4BQ7A	41 MC CASCODE
TL-33	EMERSON	470851	5 3/4"	5AT8-4BQ7A	41 MC CASCODE
TL-34	EMERSON	470841	3 1/4"	5AT8-4BQ7A	41 MC CASCODE
TL-35	EMERSON	470824	1 3/4"	5AT8-4BQ7A	41 MC CASCODE
TL-36	EMERSON	470867	6-7/16"	5AT8-4BQ7A	41 MC CASCODE
TL-37	CBS-COLUMBIA	63000721	1 3/4"	5AT8-4BQ7A	41 MC CASCODE
TL-38	EMERSON	470818	4 3/4"	5AT8-3BC5	41 MC PENTODE
TL-39	EMERSON	470857	3 3/4"	5AT8-3BC5	41 MC PENTODE
TL-40	CBS-COLUMBIA	69000642	1-3/16"	5AT8-3BC5	41 MC PENTODE

*Has pulley on shaft

Any type

In lots of 3, Each **14.25**
Singly, Each **14.95**

STANDARD COIL PENTODE TUNERS

as low as

7.95

QUANTITIES LIMITED

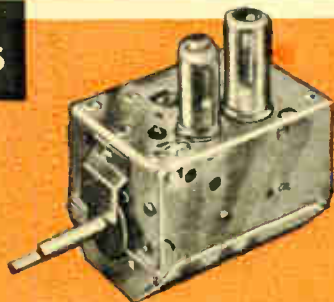

Latest type "T" Standard Coil pentode tuners complete with 2 tubes. All brand new. Shpg. wt., 4 lbs.

41MC PENTODE TUNER

Complete with 6AT8 and 6BC5 tube. Shaft 3-15/32" long.

TL-42 Net **9.95**

21MC PENTODE TUNERS

Complete with 6J6 and 6BC5 tube. Exact duplicate Olympic part CL-3856-2. Shaft 1 1/4" long.

TL-41 Net **7.95**

SPECIAL TRANSFORMER

Primary 115V AC. Secondaries 6.3V at .3 amp and 180V at 20 ma. Mtg. centers 2 3/8". Shpg. wt., 1 lb.

TR-89 **69c**

VIDEO DETECTOR COIL WITH IN105 DIODE

The IN105 Diode which just snaps out of its holder is worth more than the price of the whole assembly. Exact replacement for Sylvania part 57-73869-1. Shpg. Wt., 6 ozs.

SP-90—In lots of 10, each..... **35c**
Singly, each..... **39c**

WIDTH OR LINEARITY CONTROL



Replacement for thousands of Sylvania and other sets. For use as width or linearity control. Adjustable over wide range from 875 uh to 7.3 M.H. Shpg. wt. 4 ozs.

TS-214—In lots of 10, each..... **25c**
—Singly, each..... **29c**

RCA VHF AND UHF TUNERS

QUANTITIES LIMITED

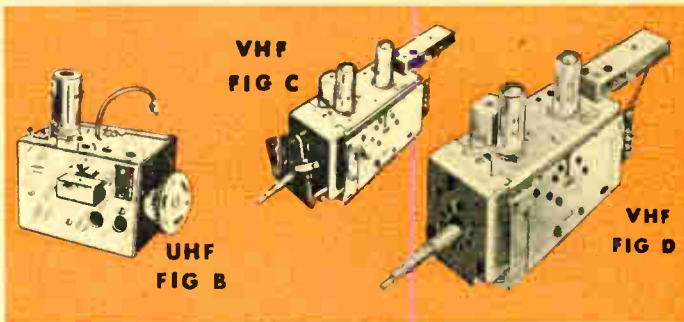

RCA TUNER MODEL	RCA STOCK NUMBER	TYPE	TUBES & DIODES	FIG.	IN LOTS		
					SHPG. WT.	SINGLY EA.	OF 3 EACH
KRK-11A	77150	VHF	1 Ea. 6BQ7A, 6x8	D	7	5.95	5.45
KRK-11B	77662	VHF	1 Ea. 6BQ7A, 6x8	D	7	5.95	5.45
KRK-22A	77845	VHF	1 Ea. 6BQ7A, 5x8	D	7	5.95	5.45
KRK-29	78230	VHF	1 Ea. 6BQ7A, 6x8	C	7	5.95	5.45
KRK-29A	78416	VHF	1 Ea. 6BQ7A, 5x8	C	7	5.95	5.45
KRK-27	78251	UHF	1 Ea. 6AF4, 1N82	B	4	4.95	4.45

MALLORY UHF INDUCTUNER

Here's a buy! Each unit contains the famous Mallory 3 gang UHF inductuner covering 470 to 890MC—the entire UHF TV band. The manufacturer who used these never completed his sets, so in addition to the inductuner there are miscellaneous other parts. The inductuner alone lists at \$15.00. Shpg. Wt. 4 lbs.

TL-28.....Net **1.49**

95c



YOU CANT BEAT LAFAYETTES LOW WHOLESALE PRICE

COPPER SHIELDED TV POWER TRANSFORMERS

QUANTITIES LIMITED

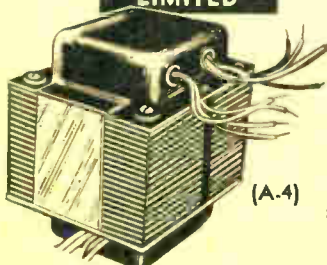

300 MIL POWER (A-4)

Exact replacement for Sylvania part 55-83618-1 and for general replacement in thousands of other sets. Plate voltage 600 volts C.T. at 300 mill, rectifier 5 V. at 6 amps, F11 #1-8.3 V. at 12 amps, F11 #2-8.3 V. at 1.25 amp. Mtg centers 3 1/4"x3". Shpg. Wt. 13 lbs.
TR-71—In lots of 3, each... **3.75** Singly, each... **3.95**

250 MIL POWER (A-4)

Exact replacement for Sylvania part 55-83403-1 and for many GE, Westinghouse sets. Plate voltage 650 V.C.T. at 250 mill, rectifier 5 V. at 3 amp, F11 #1-6.3 V. at 10 amp, F11 #2-6.3 V. at 1.25 amp. Mtg centers 3 1/4"x3". Shpg. Wt. 11 lbs. TR-72—In lots of 3, each... **3.95** Singly, each... **3.75**

T.V. POWER WITH DUAL H.V. AND DUAL RECT. (A-4)

Multiple H.V. and rectifier windings make this a fine unit to have on hand for hard to find replacements. Exact duplicate Sylvania 55-83418-1 and usable in thousands of other sets. Plate voltage #1-650 V.C.T. at 150 mill, plate voltage #2-290 V.C.T., rectifier #1-5V at 3 amp, rectifier #2-5V at 3 amp, F11-8.3 V. at 13.5 amp. Mtg centers 3 1/4"x3". Shpg. Wt. 12 lbs.
TR-73—In lots of 3, each... **3.25** Singly, each... **3.50**

GERMANIUM DIODES

SALE-QUANTITY LIMITED

WESTERN ELECTRIC

TYPE 1N22

Reg. 5.00. Great value for experimenters.
SP-83..... ea. 19c
10 for 1.75



TV FOCUS AND PICTURE CENTER



Used in 17 to 21 inch TV sets. Screw-driver slotted shaft for simple focus adjustment. Lever for centering picture vertically and horizontally. Can be used in thousands of sets using permanent magnet focusing and centering. Original Telesling LF-9 replacement. Shpg. wt., 1 lb

T5225 Net 1.10
in lots of 3, each .98

VERTICAL OUTPUTS QUANTITY LIMITED



8.5:1 RATIO

Vertical output transformer. Ratio 8.5:1. Exact replacement Emerson part 738068. Good general replacement. Mtg. centers 3 1/4". Shpg. wt. 2 lbs.

TR-35..... Singly, Ea. .49
In Lots of 3, Ea. .39



FOR 90° SETS

Crosley part C1559-66-1-1 used in 24" and 27" sets in circuits from 6S4 to 90° yoke. Exact replacement for thousands of Crosley series 411, 412, 414 and 416 chassis. Ratio 15:2:1. Shpg. Wt. 2 lbs.

TR-44—Lots of 3, each..... 85c
Singly, each..... 98c



45:1 RATIO

You can afford to stock up at this price. 45:1 ratio vertical output. Exact replacement for Sylvania part 56-91569, replaces Hallcrafters and many others. 2 3/4" mtg centers. Shpg. Wt. 1 1/2 lbs.

TR-74—In lots of 3, each..... 39c
Singly, each..... 49c



18:1 RATIO

Another good general replacement. Vertical output with ratio of 18:1. Primary 10 mil, DC. Replaces Stancor A8141 and similar units. Auto transformer type. Mtg centers 3 1/4". Shpg. Wt. 2 lbs.

TR-75—In lots of 3, each..... 59c
Singly, each..... 69c



44.4:1 RATIO

Vertical output transformer. Ratio 44.4:1. Exact replacement Hallcrafters part 55C192. Auto transformer type. Mtg. centers 2-13/16". Shpg. wt. 1 1/2 lbs.

TR-39..... In lots of 3, Each .39
Singly, Each .49



TV CONTROLS WITH SWITCH

Front section 1500 ohms, rear 1 meg topped of 250,000. Shaft lengths from bushing 1 1/2" and 1 1/4".

VC-16..... In lots of 5, each 39c
Singly, Each 45c

SERVICEMAN'S SPECIALS

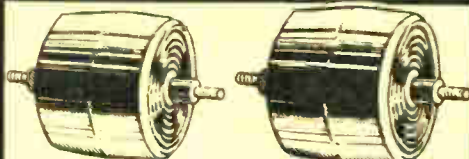

20,000 VOLTS 30,000 VOLTS 25,000 VOLTS

500 MMF TV CERAMICS

500 MMF 20 K.V. 1 end threaded. 1 end tapped	STOCK NO. C-600 49c ea. in lots of 5 singly ea. 56c	500 MMF 30 K.V. Both ends threaded	STOCK NO. C-605 58c ea. in lots of 5 singly ea. 68c
---	---	--	---

500 MMF-25KV STOCK NO. C607—In lots of 5, each... 55c
Singly, each... 65c

4 WATT WIRE WOUND FOCUS CONTROL



Replacement for majority of TV sets. 4 watt 1500 ohm with knurled shaft.

VC-12..... each, 78c
Lots of 5, ea., 69c
2 watt focus control
Rated 2 watt 1500 ohm, S.D. 3/4" shaft.
VC-13..... each, 19c
Lots of 5, ea., 15c

T.V. CONTROLS



QUANTITIES LIMITED

2 watt wire wound 1,000 ohms. Standard bushing 3/4" long and 3" shaft with split knurled end. 1 1/4" diam. Illustration A.

VC-21—In lots of 10, each..... 15c
Singly, each..... 19c

Contrast control 300 ohms. 3/8" diam. Bushing and shaft 1/2" long. Illustration B

VC-22—In lots of 10, each..... 15c
Singly, each..... 19c

Vertical synch. control. Resistance 2.2 meg. 3/4" diam. 1/2" shaft. No bushing. Mounts by metal tabs on back. Illustration B

VC-23—In lots of 10, each..... 15c
Singly, each..... 19c

TV

CHOKES

QUANTITIES LIMITED



240 MIL
Rated 1.2 HY at 240 mil. DC resistance 28 ohms. Shpg. Wt. 1 1/2 lbs.

TR-67—Lots of 3, each..... 49c
Singly, each..... 59c

180 MIL
Rated 1.4 Hy at 180 mil, DC Resistance 83 ohms. Shpg. Wt. 1 lb.

TR-68—Lots of 3, each..... 45c
Singly, each..... 49c

PP 6V6 OUTPUT

45c ea. in lots of 3

STOCK NO. TR-66 Singly, 49c
Strap mount standard 5 lead PP 6V6 output 3.2 ohm secondary. Good quality general replacement. Shpg. Wt. 1 lb.

PP 6V6 OUTPUT

SPLIT PRIMARY

Dual purpose. Use as standard push-pull 6V6 output by coupling the split windings; or for excellent response with elimination of phase inverter circuit, use all 6 leads. 3.2 ohm secondary. Shpg. Wt. 1 lb.

TR-65—Lots of 3, each..... 39c
Singly, each..... 45c

OUTPUT XFRS



TYPE "A"

Matches 6K6 to 3.2" voicecoil. Mtg centers 2"x1 1/4" high. Shpg. wt. 8 ozs.

TR-55—In lots of 3, each 39c
Singly, each..... 45c

TYPE "B"

Primary 6500 ohms. Matches 6K6, 6AQ5, 6F6 to 3.2 ohm V.C. 1500V insulation. Mtg centers 2"x1 1/4" high. Shpg. wt. 1 lb.

TR-69—In lots of 3, each 39c
Singly, each..... 45c

VERTICAL BLOCKING OSCILLATOR XFRS

QUANTITY LIMITED

RATIO 1:4.2

One of the most universal replacements for thousands of popular sets. Similar to Stancor A8111. Height 1 1/4" mounting centers 2". Shpg. Wt. 1/2 lb.

TR-70..... Lots of 3, each 69c
Singly, each... 79c

VERTICAL OUTPUTS 99c QUANTITY LIMITED

Exact duplicate transformers usable in thousands of sets in addition to the ones listed. Average shpg wt. 2 lbs.

Stock No.	Turns Ratio	Original Mfg Part	Mounting Centers
TR-35	8.5:1	Emerson 738066	3-1/8
TR-38	18:1	Avrin C2490-1	3-1/8
TR-39	44.4:1	Hallcrafters 55C192C	2-13/16
* auto			

Your cost—lots of 5 assorted singly each 39c
49c

You'll Talk About These Lafayette T.V. Values

TALK ABOUT YOKES



COSINE YOKES

Stock up on this assortment of popular yokes at give-away prices! Most popular replacements for hundreds of thousands of sets. Quantities limited.

70° DIRECT DRIVE REPLACES RCA 74952

Most popular replacement yoke. Newest cosine type. Used in RCA, Emerson, Motorola, Capehart and other sets with direct drive system. Exact replacement for RCA 74952, Stancor replacement for RCA MD-30, Chicago JY4, DY-10, Merit MD-30, Chicago JY4, Ram Y70F30/5. With leads and network. Shpg. Wt. 1 lb.

TS-20 Net 2.95

70°—8/50 MH

Cosine yoke with horizontal inductance of 8.5 MH and vertical inductance of 50 MH. Replaces Stancor DY2A, Merit MDF-72, Ram Y70F08, DY-8A, Merit MDF-71, Ram 74925 or DY12A, Merit MD-71. Complete with Chicago TY-2. Complete with leads and network. Shpg. Wt. 1 lb.

TS-181 Lots of 3, ea. 2.75
Singly, ea. 2.95

70°—30/50 MH

Cosine yoke with horizontal inductance of 30 MH and vertical inductance of 50 MH. Replaces Stancor DY12A, Merit MD-71, Ram 74925 or DY12A, Merit MD-71. Complete with Chicago TY-2. Complete with leads and network. Shpg. Wt. 1 lb.

TS-19 Lots of 3, ea. 2.75
Singly, ea. 2.95

70°—10/50 MH

Cosine yoke with horizontal inductance of 10 MH and vertical inductance of 50 MH. Replaces Stancor DY2A, Merit MDF-70, Ram Y70F10 or Chicago TY5. Complete with leads and network. Shpg. Wt. 1 lb.

TS-190—Lots of 12, ea. 1.69
Lots of 6, ea. 1.95
Singly, ea. 2.15

70° DUMONT YOKE

Dumont Part Y2A3, 70° cosine yoke with horizontal inductance of 10MH and vertical inductance of 50MH. Will replace yokes rated 8/50. Less heads and network. Shpg. Wt. 1 lb.

TS-191—Lots of 6, ea. 1.59
Singly, ea. 1.75

53°—8/50 MH

Popular replacement for thousands of 10 and 12 inch sets. Horizontal inductance 8 MH, vertical inductance 50 MH. Replaces Stancor DY1A, Ram Y70108, or Chicago TY-1. Complete with leads and network. Shpg. Wt. 1 lb.

TS-184 98c

COPPER SHIELDED TV POWER XFERS

QUANTITIES LIMITED
HUSKY BRUTES
AT HALF PRICE



PHILCO POWER XFR

Plate voltage 432 V.C.T. at 310 mil, rectifier 5 volts at 6 amp, Fil #1—6.7 volts at 10 amp, Fil #2—6.4 volt at 1.6 amp. Exact replacement Philco part 32-8556. Shpg. Wt. 18 lbs.

TR-47 5.95

CAPEHART POWER XFR

Plate voltage 600 V.C.T. at 310 mil, rectifier 5 volt at 6 amp, Fil #1—6.3 volts at 10 amp, Fil #2—6.3 volts at 4.5 amp. Exact replacement Capehart 7503958-3. Shpg. Wt. 13 lbs.

TR-49 5.25

GENERAL ELECTRIC TV POWER XFR

A sensational buy in this copper shielded GE power transformer! Of course, Lafayette, passes the savings down to you! GE part K119J15-3, replacement in many GE 17 and 21 inch TV sets.

Plate voltage 560 V.C.T. at 340 mil, rectifier 5 volts at 6 amp. Filament 12.6 V.C.T. at 10 amp. (Used for two 6.3 volt 5 amp.) Primary 117 V.A.C., with 110 V.A.C. tap.

TR-76 Net 4.95
in lots of 3, each 4.50



PM FOCUS COIL

With Nylon Focusing rod and centering device

Here's a real value in a powerful PM focus coil. Has flexible nylon focusing shaft and built in lever operated centering device. Triangular 3 hole mounting plate. Will replace majority of P.M. focus coils. Quantity limited. Shpg. Wt. 4 lbs.

TS-202 Lots of 3, each 1.75
Singly, each 1.98



90° FLYBACK AND YOKE

TERRIFIC VALUE



90° YOKE:

Original Sylvania part 51-79079-1. Used in 24" and 27" TV sets. Complete with leads and network. Shpg. Wt. 3 lbs.

TS-212—Lots of 3, each 2.50
Singly, each 2.95

4.50

90° FLYBACK

For use with 24" and 27" picture tubes in sets employing 68G6G or (68Q6), 1B3GT and 6W4GT or similar tubes. Shpg. Wt. 3 lbs.

TS-213—Lots of 3, each 4.25
Singly, each 4.50



6.3 VOLT FILAMENT TRANSFORMER

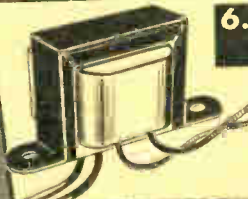

PRIMARY 115V, secondary 6.3V at .4 amp. Mounting centers 2 1/2". Shielded case. Long insulated leads. Shpg. wt. 6 oz.

TR-90 in lots of 5, Each 45¢
Singly, Each 49¢

14 KV FLYBACK

EXACT REPLACEMENT FOR ADMIRAL SETS

Exact duplicate of Admiral part 79C38-1 used in Chassis 20C1 and 20V1. Delivers 14KV in typical 14" circuits employing 6BQ6GT, 1B3GT and 6W4GT. Shpg. Wt. 2 lbs.

TS-210—Lots of 3, each 1.75
Singly, each 1.98



10 KV FLYBACK



Excellent general replacement for 12" sets. Exact replacement for Admiral part 79C28-1 used in 20Y1 and 20Z1 chassis. Delivers 10KV in circuits using 68G6G, 1X2 and 6W4GT tubes. Shpg. Wt. 3 lbs.

TS-211—Lots of 3, each 1.50
Singly, each 1.69

90° FLYBACK AND YOKE KIT

• CONVERT TO A LARGER SET

Here's a handy package to convert small size sets to use the new 90° tubes of any size up to 27". For sets employing 68G6 (or 68Q6), 1B3GT and 6W4 or similar tubes. With complete instructions. Shpg. wt. 5 lbs.

TS-194 Net 8.25

90° Yokes

Yoke only for replacement purposes. Shpg. wt. 2 lbs.

TS-195 Net 5.75



TV CHOKES: QUANTITIES LIMITED STOCK UP WHILE THEY LAST

Ind. Hy.	Curr. Ma.	DC Res. Ohms	Exact Replacement Mfr. & Part No.	Stock No.	Singly	Lots of 3 Each
1.5	140	76	TELEPHONE TTR1781D	TR-29	.59	.49
1.5	150	62	Philco 32-8479	TR-51	.65	.59
2.0	20F	34	CAPEHART 650587C1	TR-30	.89	.79
1.0	25H	60	CAPEHART 650215A3	TR-31	.79	.69
2.5	25H	67	DUMONT 21005213	TR-32	.98	.88
1.4	29H	60	FADA 42-60	TR-33	.79	.69
1.15	290	41	Westinghouse V12170-1	TR-52	.79	.69
2.3	360	46	Philco 32-8514	TR-53	1.10	.98



MAGNAVOX FLYBACK

• Delivers 19-20 KV

MAGNAVOX Part No. D360552-1A used in model CT-358, and 107 series and similar sets with 90° picture tubes in circuits using the typical 6CD6, 1B3GT and a pair of 6AX4 tubes. Has built in width control. Replaces RAM X093. Shpg. wt. 2 lbs.

2.25

lots of 3, ea. singly each 2.50

TS-193 lots of 3, ea. net 2.25
singly each 2.50



LAFAYETTES NEW UNBEATABLE PRICES!

Triple Purpose Slim Crystal Microphone



COMPLETE SET
MICROPHONE
SWEIVEL ADAPTER
LAVALIER CORD

NEW

5.95



HAND
HELD



STAND
MOUNTED



LAVALIER
CORD

- UNIVERSAL DESIGN — MAY BE HAND-HELD, STAND-MOUNTED OR SUSPENDED BY LAVALIER CORD. ALL ACCESSORIES FURNISHED.
- FREQUENCY RESPONSE 60-10,000 CPS • ON-OFF SWITCH

Here is a unique design in a high quality crystal microphone. It is slim in design, measuring only 6" long including cable connector. Mike itself measures only 4 3/8" L x 1 1/4" max. diam. and weighs only 6 oz. The special swivel stand adaptor fits an all standard 3/8"-27 stands and clamps to body of mike. Clamp is rotatable through 180°. The lavalier cord fits comfortably around neck, is adjustable for proper length and terminates in a bracket to hold microphone in proper position. This makes it ideal for lectures, demonstrators, etc., who must move about with both hands free. Has wide range smooth response for both music and voice and omnidirectional polar pattern. Locking type on-off slide switch is built-in. Attractive brushed satin-finish. Nothing like this has ever been offered before for less than about 3 times our price. Complete package consists of microphone, 7 ft. detachable cord, with cable connector, swivel stand adaptor and lavalier cord with bracket. Shpg. wt. 2 lbs.

PA-31

PA-32—DESK MICROPHONE STAND

Singly, Each 5.95 In Lots of 3, Each 5.65

\$1.49

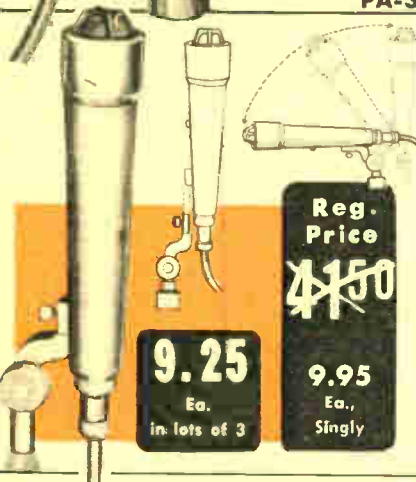

Reg.
Price

4.50

9.25

Ea.
in lots of 3

9.95
Ea.,
Singly

NEW! EXCLUSIVE!

SLIM DYNAMIC MICROPHONE

- DUAL IMPEDANCE 50,000 AND 250 OHMS
- HIGH OUTPUT • 50-11,000 CYCLES
- USE ON STAND OR AS HAND MIKE

Again Lafayette leads the field with the latest design in slim type microphones. Here is a high-output dynamic mike of exceptional quality packed with both electrical and mechanical features at a price 1/3 that of any comparable microphone on the market today. Has very smooth response from 50-11,000 cycles. Built in external switch gives you choice of either high impedance (50,000 ohms) or low impedance (250 ohms). Omni-directional tiltable head. Bracket has standard 3/8"-27 thread for use on stand. This bracket is instantly removable so mike can be handheld. Has cast case with satin-chrome finish and acoustically treated grille head. Ruggedly constructed. Size: 8" long, 1 1/4" diam. barrel. Shpg. wt. 2 lbs.

PA-29

In lots of 3, Each 9.25

Singly, Each 9.95

MICROPHONE VOLUME CONTROL ADAPTER

4.09



Designed to reduce or increase relative volume at the microphone. Used in high impedance circuits using shielded single conductor cable only. Reduces volume to workable level—reduces feedback noises. Employs standard microphone connectors—one off-center for easy mounting on mikes used with stands. Shpg. Wt. 8 ozs.

SWITCHCRAFT—329.....Net 4.09

MICROPHONE SWITCH



Attaches between male and female of 75 series connectors. Push-to-talk or slide switch for permanent connection.

Amphenol 75-MC15.....1.09

ATLAS "FULL GRIP" MICROPHONE STANDS

The "full-grip" clutch mechanism and smooth-acting telescoping tube, permit fast, quiet adjustments at all times without wear or slipping. Height adjustment from 35" to 64". Gray shrivel base gives maximum stability and includes self-leveling, shock-absorbing base pads plus three additional "anti-tip" points located between the base pads. Full chrome plated tube assemblies for lifetime wear. Base diameter 10". All models terminate in a 3/8"-27 thread. Shpg. wt. 9 lbs.

Atlas Model MS-10C.....5.73

Same as above except heavier and with tube extension to 65". Shpg. wt. 12 lbs.

Atlas Model MS-12C.....6.17

Same as above except full chrome finish on base and tube.

Atlas Model MS-11C.....7.64

ATLAS "VELVET ACTION" DESK STANDS

A decorative and fine appearing stand suitable for use on a banquet table. Uses "full-grip, velvet action" control adjustable from 18" to 32". Full chrome finish base and tube assembly. Base diameter 8". Supplied with base pads.

Atlas Model TS-6—Shpg. wt. 5 lbs.....5.29

MODEL DS-5 FIXED. Same finish and workmanship as floor models. 6" fixed height. Base diameter 6". Felt base pads included.

Atlas Model DS-5—Shpg. wt. 2 lbs.....1.76

MODEL DS-7 ADJUSTABLE. From 8" to 13". Uses heavy duty 3/8" and 1/2" tubing.

Atlas Model DS-7—Shpg. wt. 3 lbs.....2.94

AMPHENOL MICROPHONE CONNECTORS



SERIES 75. PRESSURE TYPE—SINGLE CONTACT
Polished chrome plated brass fittings with 3/8"-27 threads

Type	Fig.	Description	Each
75-MC1F	A	Female with coupling ring	.31
75-MC1M	B	Male. Fits above connector	.21
75-PC1M	C	Male. Non-shorting, chassis mount. Fits MC1F	.23
75-CL-PC1M	D	As above, except closed circuit	.33
75-MC1F-A	E	Angle type, female connector coupling ring. Use with PC1M, etc.	.62
75-MC1P	F	Adaptor. Connects MC1F to standard phone plug	.30



"Y" CONNECTOR

Has 2 male and 1 female. For use when using more than 1 mike or speaker from single circuit.

MS-84.....Net .85



FLEXIBLE GOOSENECK

Attaches to any mike stand. Can be used where moderate adjustment is required. 3/8"-27 thread; male and female ends. Chrome finish.

ATLAS GN-13—13" long.....1.62

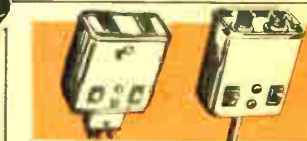

SWITCHCRAFT "MINI-MIX"

Miniature 2 Input Audio Mixer
Accommodates 2 high impedance inputs. Separate gain controls for mixing. Connected directly to equipment. No external cables. Minimum lead-length inside shielded housing minimizing "stray-pickups". Ideal for use with tape, wire, or disc recorders, amplifiers, musical instruments, etc. Size: 2-1/16" x 1-15/16" x 1-1/16".

NO. 320—WITH MICROPHONE CONNECTOR INPUTS AND OUTPUTS.....4.67

NO. 310—WITH PHONE JACK INPUTS AND PHONE PLUG OUTPUT FITTING.....4.67

No. 315—With phone jack inputs and microphone connector output mating with standard mike connectors.....\$4.67

No. 325—For recorders or amps using Jones connectors including recessed type in Webster Tape Recorders.....\$5.85

No. 8266—cable assembly with plug and jack to use No. 310 where equipment jack is recessed.....\$2.20

MICROPHONES

*Fine Quality
At History Making Prices!*

A BUY OF A LIFETIME HIGH QUALITY TOP NOTCH CRYSTAL MICROPHONE



COMPARE IT WITH
ANY MIKE AT
2 TO 3 TIMES
THE PRICE

3.95 each
in lots of 3
Singly, ea. 4.25

Lafayette makes history with a high quality CRYSTAL MICROPHONE at a price that is 60% less than any comparable Crystal Microphone on the market today. Excellent for PA systems, home recorders and general applications. Frequency response 30 to 10,000 cycles. Output level—52 db. Provides ample output for use with low gain amplifiers. Uses quality moisture sealed crystal. Die cast case in rich green baked enamel finish, with chrome grill. Completely equipped with 5 feet of shielded cable. Mike may be used on any stand with 3/4" x 27 thread. Grill diameter 2 3/4", depth 4/4", height 4 1/2". Shpg. Wt. 3 1/2 lbs.

STOCK NO.
PA-24

3.95
4.25

PA-24—In lots of 3, each
Singly, each

STUDIO CRYSTAL MICROPHONE

- DUAL CRYSTAL CARTRIDGES
- ALL DIRECTIONAL
- FINE QUALITY
- HIGH OUTPUT

6.95
ea. in lots of 3,
single, each
7.25



Here is a microphone with a 360° pickup, and the added power and sensitivity of two individually shock mounted and phased crystal cartridges. This arrangement assures you of maximum pickup from all sides. Swivel mounted to give fuller flexibility. Case is chrome plated. Standard 3/4" x 27 thread. Overall size 7" H x 3" W complete with 4 ft. cable. Shpg. wt. 4 lbs. PA-17—

In lots of 3, each **6.95**
Singly, each **7.25**

CRYSTAL MICROPHONE CARTRIDGE

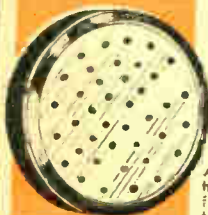

- REPLACEMENT FOR
ASTATIC SHURE, AND
MANY OTHER POPULAR
MICROPHONES

1.95

A universal crystal microphone cartridge with heavy flexible rubber cushioned rim designed for speedy, economical repair. Fits tens of thousands of the most popular microphones such as the astatic JT 30 etc. Overall diameter 2 1/4", depth 1/2". Output—52 db. Excellent frequency response. Shpg. wt. 8 oz.

PA-27—In lots of 3, each **1.75**
Singly, each **1.95**

A Fantastically Low Price!

HIGH OUTPUT DYNAMIC MICROPHONE WORTH MANY TIMES ITS PRICE

List Price
~~547.00~~



12.45 ea.
In Lots of 3
Single, ea.
12.95

AT LAST! A HI-FI Dynamic Mike for Public Address etc. at a price you'd expect to pay for a good crystal mike!

Lafayette went abroad to obtain a high quality DYNAMIC MICROPHONE at a price that is 66% less than any comparable dynamic microphone on the market today. Exceptionally fine for public address, recording and other general purpose use. Substantially flat response, 60-10,000 cps. assures faithful reproduction of speech, music, and voice. Die cast metal case finished in light grey and fine chromium. Compact and light weight. Net Wt. 1 lb. Head at fixed tilt of 15°, equipped with 5 ft. well shielded low-loss special vinyl-jacketed cord. Standard 3/4" x 27 thread. Dimensions 1-23/32" high, 2" wide, 1 1/2" deep. Shpg. Wt. 3 lbs.

STOCK NO
PA-19

LAFAYETTE'S OWN LAPEL MICROPHONE

- FULL —55 db. OUTPUT LEVEL! Reg. 16.00 Value
- IDEAL GENERAL PURPOSE MIKE!



Most compact—specially engineered crystal microphone. Attaches to the lapel. Only 1 1/4" in diameter. Fantastically light weight—weighs only 1 1/2 ozs. including 3 feet cord! Exceptional frequency responses provides high level speech intelligibility. Output level —55db. "Sealed-in" moisture proof crystal—pressure actuated. Handsome, heavily chrome plated case and clip for attaching to lapel. Ideal for inexpensive P.A. systems—hams—home recording—general purpose. High impedance. Includes 5 ft. of extra light weight shielded single conductor cable. Shpg. Wt. 1 lb.

PA-18
Net 2.95

Never Before
At This
History Making
Price!

A LAFAYETTE SCOOP!

Top Quality

CRYSTAL
MIKE

2.95



New, attractively styled crystal microphone for all general applications—public address, home recordings etc. Frequency response 30 to 10,000 cycles. Output level—52 db; tilting head. Chrome grill. Completely equipped with 5 feet of shielded cable. Grill dia. 2 1/4", depth 3/4", height 4". Shpg. wt. 3 lbs. One of the best buys in the country.

PA-28
Each **2.95**

MINIATURE CRYSTAL MICROPHONE



1.95

Here's a typical Lafayette special for the experimenter, student or dealer. An extremely sensitive and small crystal microphone used in hearing aids and other small apparatus. Can be used as lapel mike—miniature transmitter mike—far concealed locations, etc. Its size and performance gives it joint versatility. Brand new. Size only 1 1/4" Diam. x 5/16" deep. Imported to save you money.

MS-196.....Net 1.95

10 Watt Permanent System

This is the same high quality, low-cost system that's especially engineered for all those mail-order permanent installations. Covers audiences up to 1,200 and seats up to 5,000 sq. ft. The complete system includes the famous PA-10-watt amplifier (15 watts peak output) and a 10-watt speaker with four 2 1/2" drivers. The speaker can be removed and the stand can be designed for high response audio work with 35 ft. of speaker cable and plug. The theatre-covered wall panel is ready to be operated for 100-150/500 cycles AC. And as covering defective parts or workmanship on the amplifier.

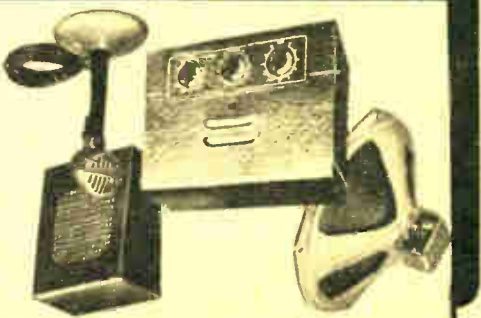

Stock No. PA-10—Complete 10-Watt Permanent System.....Net 36.50

Net coverage of 275,000 square feet and up to 40,000 persons with use of trumpet type speakers. Meets all requirements of typical industrial installation. TECHNICAL SPECIFICATIONS—TUBES: 1-6X4, 1-6X5, 1-6X6, 1-6X7, 1-6X8, 1-6X9, 1-6X10, 1-6X11, 1-6X12, 1-6X13, 1-6X14, 1-6X15, 1-6X16, 1-6X17, 1-6X18, 1-6X19, 1-6X20, 1-6X21, 1-6X22, 1-6X23, 1-6X24, 1-6X25, 1-6X26, 1-6X27, 1-6X28, 1-6X29, 1-6X30, 1-6X31, 1-6X32, 1-6X33, 1-6X34, 1-6X35, 1-6X36, 1-6X37, 1-6X38, 1-6X39, 1-6X40, 1-6X41, 1-6X42, 1-6X43, 1-6X44, 1-6X45, 1-6X46, 1-6X47, 1-6X48, 1-6X49, 1-6X50, 1-6X51, 1-6X52, 1-6X53, 1-6X54, 1-6X55, 1-6X56, 1-6X57, 1-6X58, 1-6X59, 1-6X60, 1-6X61, 1-6X62, 1-6X63, 1-6X64, 1-6X65, 1-6X66, 1-6X67, 1-6X68, 1-6X69, 1-6X70, 1-6X71, 1-6X72, 1-6X73, 1-6X74, 1-6X75, 1-6X76, 1-6X77, 1-6X78, 1-6X79, 1-6X80, 1-6X81, 1-6X82, 1-6X83, 1-6X84, 1-6X85, 1-6X86, 1-6X87, 1-6X88, 1-6X89, 1-6X90, 1-6X91, 1-6X92, 1-6X93, 1-6X94, 1-6X95, 1-6X96, 1-6X97, 1-6X98, 1-6X99, 1-6X100.

Net 89.50

WHERE—NO WIRES REQUIRED
• TAKE IT ANYWHERE • USE IT ANY.
• JUST PLUG-IN AND TALK
• NEW NOISE SILENCING CONTROL

MASCO TWO-STATION WIRELESS INTERCOM

Top Quality CRYSTAL MIKE

52 db output level • Range 30 - 10,000 cps
• 10 ft. cable and locking base
• Use for amateur broadcasting, public address and home recording. Can be used with floor stand. Shpg. wt. 2 1/2 lbs.

PA-21

PORTABLE PA CASE

NET 13.95

MIKE ADAPTERS

NET 1.62

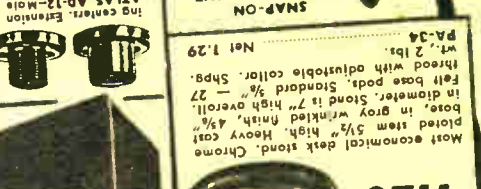
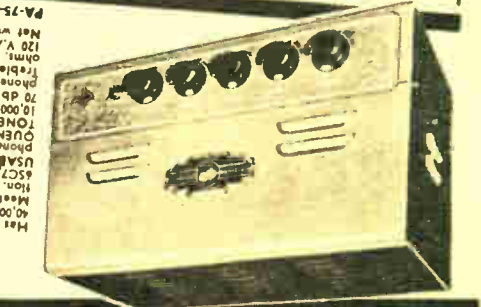

MIKE ATTACHMENT

NET 1.62

TRUMPETS

University REFLEX PROJECTORS

UNIVERSITY DRIVER UNITS

WIDE ANGLE PAGING SPEAKERS

3 WATT COBRA

PAGING - TALK BACK SPEAKERS

LOW POWER UNIT

WIDE RANGE HI-FI COAX SPEAKER

ELECTRO-VOICE COMPOUND DIFFRACTION PROJECTOR

NET 40.87

NET 9.70

NET 10.29

NET 9.70

NET 9.70

NET 1.62

NET 1.62

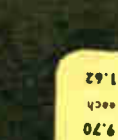
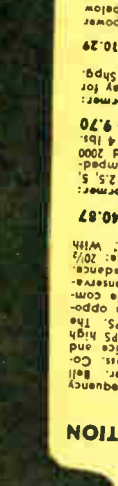
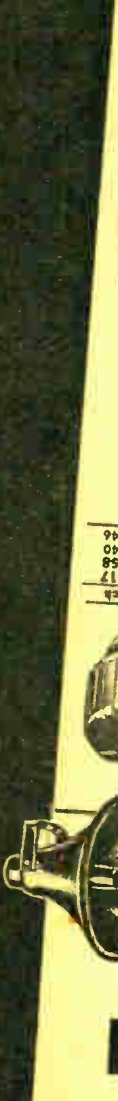

GREAT LAFAYETTE BUYS!



MASCO "BALLYHOO" 6 WATT SYSTEM

- LOW COST — HIGH PERFORMANCE.
- PERFECT FOR GROUPS UP TO 100 PEOPLE.

Especially recommended for Carnivals—Demonstrators—Garages—Stock—Auctioneers—Bingo—Small Clubs and Taverns. Provides enough sound power for groups of 100 people or more. Built in 3 speed manual phonograph. Voice and Music may be mixed. Heavy duty 8" PM high quality speaker built into acoustically designed carrying case. Covered in two toned grey pigskin and tweed leatherette. All controls and sockets are accessible from the back with the cover in place. Complete system includes: 6 watt amplifier with tubes, crystal microphone with 15 ft. of cable, 8" P.M. Alnico 5 speaker, carrying case and back, 3 speed phonograph with turnover crystal cartridge, web strap for carrying microphone. Size 12 3/4" x 6 1/2" x 17" high. Shpg. Wt. 21 lbs.

CS-6P-3 Net 64.68
CS-6—Complete Ballyhoo System, less built-in phonograph 44.10

6 Watt Amplifier

Separate inputs for Phono and Microphone. Separate volume and tone controls. 4 and a 4 ohm taps for any speaker. Characteristics rated for long life. Tubes: 12AN7, 6X5GT, rectifier. Power consumption 35 watts at 117 volts AC—100 cycles only. Frequency response—30 to 12,000 cps ± 2 db. Gray hammer-tone finish. Size 9 1/2" x 6 1/2" x 17". Complete with tubes. Shpg. Wt. 7 lbs.

C-6.....Net 19.55

Bogen 30-WATT AMPLIFIERS & SYSTEMS



CH30X

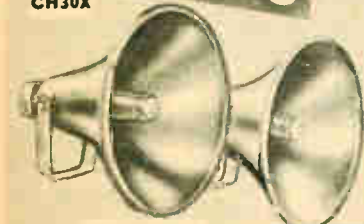

UNIVERSITY PH



CH18P

Serves admirably for those installations requiring medium power, more inputs and/or built-in phono. Three inputs. Two speaker outlets plus speaker terminal strip outlets. 4 position tone control. Power output: 30 watts. Response: 30 to 12,000 cps. ± 2 db. Gain: Mikes, 118 db. Phono, 85 db. Output Impedances: 4, 8, 15 ohms, 70V. Tubes: 2-6SC7, 6SL7GT, 2-6L6, 5U4G. Dimensions: CH30, 15" W x 10" D x 8" H.

CH30Y, 15" W x 10" D x 10" H.
CHALLENGER CH30 with Tubes and Cage 58.05
CHALLENGER CH30Y with Tubes and Built-in 3-speed Phono Top. 77.55

CHALLENGER CH30P: Complete Portable System. CH30 amplifier, 2-12" Alnico V PM speakers each with 25 ft. cable and plug, mounted in split portable speaker baffle which also carries the amplifier. Plus 1 Astatic JT-30 Crystal Microphone with handle, interlocking base, 15 ft. cable and plug. 106.68

CHALLENGER CH30YP: Complete Portable System. Same as CH30P except 3-speed phono top (CH30Y) is supplied. 126.18

CHALLENGER CH30B: Complete Indoor System. CH30 amplifier, 2-12" Alnico V PM speakers, each with 25 ft. cable and plug, mounted in 12" hand-finished wall baffles. Plus 1 Astatic JT-30 Crystal Microphone with handle, interlocking base, 15 ft. cable and plug. 99.60

CHALLENGER CH30YB: Complete Indoor System. Same as CH30B except 3-speed phono top (CH30Y) is supplied. 119.10

CHALLENGER CH30T: Complete Outdoor System. CH30 amplifier, 1 University PH trumpet with MA25 driver unit. Plus 1 Astatic JT-30 Crystal Microphone with handle, interlocking base, 15 ft. cable and plug. 103.32

CHALLENGER CH30YT: Complete Outdoor System. Same as CH30T except 3-speed phono top (CH30Y) is supplied. 122.82

18-WATT AMPLIFIER & SYSTEMS

An all purpose amplifier which meets the requirements of the majority of installations such as churches, small factories, small outdoor mass meetings, etc. Two inputs and 2 speaker plugs plus terminal strip outlets. 4 position tone control. Power output: 18 watts. Response: 30 to 12,000 cps ± 2 db. Gain: Mike, 118 db. Phono, 78 db. Output impedances: 4, 8, 15 ohms, 70V. Tubes: 2-6SF5, 1-6SL7GT, 2-6V6GT, 1-6Y3GT. Dimensions: 14" x 8" D x 8" H. Shipping weight 20 lbs.

CHALLENGER CH18 with Tubes and Cage 48.90

CHALLENGER CH18B: Complete Indoor System. 1-CH18 amplifier, 2-12" Alnico V PM speakers each with 25 ft. cable and plug, mounted in 12" hand-finished wall baffles. Plus 1 Astatic JT-30 Crystal Microphone with handle, interlocking base, 15 ft. cable and plug. 90.90

CHALLENGER CH18P: Complete Portable System. CH18 amplifier with cage, 2-12" Alnico V PM speakers, each with 25 ft. cable and plug, mounted in split portable speaker baffle which also carries the amplifier. Plus 1 Astatic JT-30 Crystal Microphone with handle, interlocking base, 15 ft. cable and plug. 98.10

Challenger



SYSTEM 1—One master and up to 5 remote stations. Master can call all remotes simultaneously. (Requires 3 conductor cable)

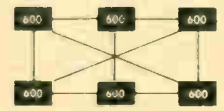

SYSTEM 2—All Master System. Maximum of 6 masters, if each must talk with every other master. Otherwise, more than 6 may be used.

CHALLENGER INTERCOM SYSTEM

The Challenger "600" master station will operate in a system using a single master and up to five remote stations, or in an all master system of six stations. When used in a single master — multiple remote installations, the "Mute" position silences the background noise at the remote stations, yet the remote can still initiate a call to the master. The "ALL" position permits a master station in either type system to call all other stations simultaneously. The "600" Master station is housed in a sturdy polystyrene cabinet, 6 x 6 1/2 x 7" D. Has press-to-talk switch, 7 position selector switch and volume control, on off. The "60R" remote station has a matching cabinet and is equipped with an initiating call bar. During conversation with the master, the remote does not operate any control. Master station complete with tubes, operates on 117 volts AC DC Underwriter's Laboratories approved Shpg. wt 600, 6 lbs., 60R 3 lbs.

600 Master Station, Each NET 23.43
60R Remote Station, Each NET 7.76
P16055 — System 1, 3 Cond. Cable 100 Ft. 4.06; Per Ft. 49¢
P16056 — System 2, 7 Cond. Cable 100 Ft. 7.35; Per Ft. 8¢

MASCO E-Z TALK 2 Station Intercom System



- First Time at a Price to Fit Everybody's Purse!
- For Home Intercom or Baby-Sitter

12.75

A complete 2 station intercom system that is easy to install and simple to operate. Master station has volume control with on-off switch. Remote can answer calls from a distance as there is no switch to operate on remote. Remote is always "open", making its use as a "baby-sitter" ideal. Low hum and noise. Alnico V PM speakers. Metal cabinets—size: 6 1/2" x 3 3/4" x 4 1/2" H. System is complete with 2 stations, 50 ft. of cable and instructions. Shpg. Wt. 6 1/2 lbs.

MASCO E-Z TALK SYSTEM NET 12.75

MASCO 2-STATION INTERCOM SYSTEM



Complete with 50 ft. cable

Easy to Install—Simple to Operate. This extremely low cost complete two-station system makes it possible for every home and every office to enjoy the convenience of two-way intercommunication. For restaurants, homes, nurseries, offices, bookstores, factories. FEATURES: Volume control with on-off switch. Separate "press-to-talk" switch. On-Off pilot light. Remote can be left "open" for baby-sitting or dictation, or "closed" for privacy but still able to receive calls from the Master. Voltage: 117 volts AC or DC. Power Output 1 1/2 watts. Power Consumption—30 watts. Tubes 1-6Y3GT, 2-6V6GT, 1-6Y3GT, 2-6V6GT, 1-6Y3GT, 2-6V6GT, 1-6Y3GT. Speakers in Master and remote are 1" Alnico V, 1 inch voice coil. Pilot Light N1-2. Low Hum, Low Noise. All stations finished in attractive brown lacquer. All Metal equipment—unbreakable. Ample Sensitivity. Natural Voice Reproduction. Dimensions Master and Remote 6 1/2" x 3 3/4" x 4 1/2" high. Shpg. wt. of system 6 1/2 lbs.

MASCO "SMALL TALK" List \$29.95.....Net 17.64

SIZZLING P.A. PRICES!

Guaranteed For One Full Year

FAMOUS 10 WATT P. A. AMPLIFIER

\$24.50

COMPLETE WITH TUBES

Top Quality - Fully Guaranteed



Provides extensive coverage up to 20,000 square feet when used with trumpet speakers. Unit is applicable to store demonstrations, clubs, churches, offices, classrooms, auction sales, entertainment, etc. Incorporates latest circuit features for improved 10 watt performance. Separate controls for microphone, phono and tone permits blending or mixing microphone and phono. Two-speaker output sockets on chassis for use with portable systems. Removable escutcheon plate for added convenience. Cabinet is finished in baked hammerloid blue-gray enamel.

Technical Specifications

Tubes: 1-6SC7, 1-6L6, 1-5Y3GT.
Usable Wattage: 12 Watts
Input Gain: Microphone 105 db 2.2 Meg., Phono 65 db 1/2 Meg.
Frequency Response: 70 to 10,000 cps, ± 2 db.
Tone Control Attenuation: Treble 15 db at 10,000 cps.
Controls: 3; Microphone, Phono or Radio, Tone.

Output Impedances: Four and Eight Ohms.
Hum and Noise: 60 db below maximum output
Power Consumption: 70 Watts, 110/120 V. A. C. 60 Cycles.
Size: 7 3/4" H, 10 3/4" W, 5 3/4" D.
Net Weight Approx.: 10 lbs.

PA-11—Complete with Tubes **24.50**

15 WATT P.A. AMPLIFIER

For The Finest Sound System

New improved circuit features insure top performance. Designed to give wide range response and meet power requirements of shops, clubs, schools, restaurants and industrial plants. Covers up to 20,000 square feet when used with trumpet type speakers. Chassis equipped with 2-speaker output sockets for use with portable systems. Housed in well ventilated case of all steel construction. Removable escutcheon plate for added convenience. Large instrument control knobs. Cabinet is finished in baked hammerloid blue-gray enamel.

Technical Specifications

Tubes: 1-6SJ7, 1-6SC7, 2-6V6GT, 1-5Y3GT.
Usable Wattage: 15 Watts.
Input Gain: Microphone 115 db 3.3 Meg., Phono 70 db 1/2 Meg.
Frequency Response: ± 2 db from 40 to 10,000 cps on Phono and Microphone channels.
Tone Control Attenuation: Treble 15 db at 10,000 cps.

Hum Level: 70 db below rated output.
Controls: 4; Microphone, Phono, and Tone Control.
Power Consumption: 75 Watts, 110/120 V. A. C. 60 cycles
Size: 8" H, 14" W, 8" D.
Net Weight Approx.: 12 lbs.

PA-16—Complete with Tubes . . . Net **35.50**

3-SPEED PHONO TOP

For above amplifier. Fits in place of cover. Plays all speeds—78, 33-1/3 and 15 RPM. Has constant 3-speed motor, with turner cartridge, complete with two precious metal needles. Has arm-rest and plug connection, for 110 Volt 60 cycle

PA-50—3-speed Phono Top

\$35.50

WITH TUBES



Net **17.25**



\$44.25

WITH TUBES

30 WATT P.A. AMPLIFIER

Sound At Its Best

New improved model of the extremely popular and economical 30 watt amplifier. Ideal for use in churches, schools, small theaters, lecture halls and industrial plants. Priced extremely low to give extra profits to rentals and sales. Continuous variable tone control permits adjustments to meet all acoustic requirements. Provides coverage up to 200,000 square feet when used with trumpet type speakers. Chassis is equipped with 2-speaker output sockets for use with portable systems. Unit is housed in sturdy steel constructed, well-ventilated cabinet. Available with or without phonograph top. Finished in baked blue gray hammerloid enamel. Removable escutcheon plate for added convenience.

Technical Specifications

Tubes: 2-6SC7, 1-6SQ7, 2-6L6, 1-5U4G.
Usable Wattage: 30 Watts.
Input Gain: Microphone 120 db 3.3 Meg., Phono 80 db 1/2 Meg.
Frequency Response: 20 to 20,000 cps, ± 2 db
Tone Control Attenuation: Treble 15 db at 10,000 cps
Hum Level: 75 db below rated output.

Controls: 4; Microphone-1, Microphone and Phono-2, Phono-1, and tone.
Output Impedances: 3-4 8-16-20-500 Ohms.
Power Consumption: 190 Watts, 110/120 V. A. C. 60-60 cycles
Size: 8" H, 14" W, 8" D.
Net Weight Approx.: 17 lbs.

PA-26—Complete with Tubes . . . Net **44.25**

3-SPEED PHONO TOP

For above amplifier. Fits in place of cover. Plays all speeds—78, 33-1/3 and 45 rpm. Has constant 3-speed motor, with turner cartridge, complete with two precious metal needles. Has arm-rest and plug connection, for 110 Volt 60 cycle

PA-50—3-speed Phono Top

Net **17.25**

30 WATT MOBILE P.A. AMPLIFIER

6V OR 12V BATTERY AND 110V AC OPERATION
SEPARATE BASS AND TREBLE CONTROLS

Powerful new 30-watt Mobile Amplifier designed for sound trucks and other outdoor application as well as indoor use. Operates from any 6 or 12 volt storage battery or from 110V A.C. Efficient, hum-free or ripple-free operation on all power sources. Has economizer switch to save power during stand-by periods. Wide flexibility of microphone and phono inputs with provisions for mixing and fading and wide selection of speaker output impedances. Quick change from mobile to indoor operation by simple switch of power cable. Changeover from 6 or 12 volt operation is accomplished by the flip of a switch. Built-in converter permits operation of the 3-speed phono, which is supplied from 6 or 12 volt DC source, as well as from 110V AC source. Provides low distortion coverage up to 100,000 sq. ft. when used with trumpet-type speakers. Two speaker outlets for use with portable systems. A dependable, rugged, versatile mobile amplifier!

TECHNICAL SPECIFICATIONS

TUBES: 3-12AX7, 2-6L6GB, 2-6X5GT and 6V6B
Vibrator
USABLE WATTAGE: 30 Watts
INPUT GAIN: Microphones 125 db 4.7 meg.
Phono 80 db .5 meg.
FREQUENCY RESPONSE: ± 1 db, 20-20,000 cps
BASS: +15 to -15 db
TREBLE: +15 to -15 db
HUM LEVEL: 65 db below rated output
CONTROLS: 5; MICROPHONE 1, MICROPHONE 2, PHONE, BASS, TREBLE

SWITCHES: Dual Purpose AC ON-OFF and VIBRATOR ON-OFF; FILAMENT ON-OFF; 6V-12V SELECTOR
OUTPUT IMPEDANCE: 3.2, 4, 8, 16, 500 ohm plus 70 volt line.
POWER CONSUMPTION: 130 watts, 117V 50/60 cycle AC; 6V battery 24A; 12V battery 12A; fused separately
PHONO TOP: 3-speed motor and dual stylus ceramic pickup
POWER CABLES: 1 AC cable and 1 DC cable
SIZE: 8 1/2" H, 16" W, 10" D
SHPG. WT.: 45 lbs.

PA-33 Amplifier Complete with Tube and Phono Top

Net **99.50**



\$99.50

With Tubes and Phono Top

COMPARE ANYWHERE-

Lafayette

SOUND SYSTEMS

YOU GET MORE FOR YOUR DOLLAR!

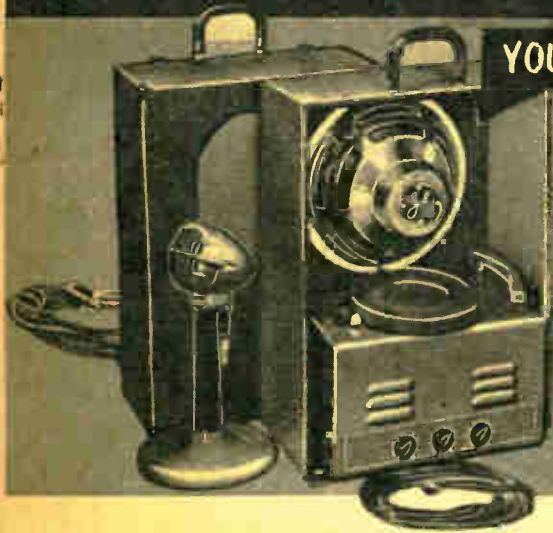

DUAL SPEAKER 15-WATT PORTABLE SYSTEM

Here is a complete 15-Watt Dual Speaker (Two G.E. 25-Watt 12" PM Speakers) Portable System, that gives you more watts and greater performance, packed with the latest features, at a price that beats all competition. Ideal for lectures, auctions, taverns, traveling orchestras; excellent as a rental system. And don't forget LAFAYETTE'S MONEY BACK GUARANTEE. If you don't agree that Lafayette's Sound System meets every claim we make for it, send it back—anytime within 15 days—and Lafayette will refund every penny—less only transportation charges.

Complete Portable System ready to operate includes: Two G.E. 25-Watt 12 Inch PM speakers. The 15-Watt PA-16 Amplifier complete with tubes packed with its many features described on next page; includes the popular Astatic Model JT-30 Crystal Microphone, with hand stand and 10 feet of mike cable and plug; 70 feet of speaker cable (4 1/2 ft. for each speaker) and plugs. Handsome portable case with compartment provides a secure place for every component. Case is covered with high quality dark blue leatherette. Size: 22 1/2" H x 16 1/2" W x 15" D. For 110-130 Volt, 50-60 cycle operation. Carrying weight 30 lbs. Shpg. wt. 35 lbs.

Any of the Systems available with any other mike desired at additional cost. For other mikes see Mike page.

PA-105—15-Watt Portable System Less Phone Top..... Net **73.50**
 PA-106—With 3-speed Phone Top..... Net **89.95**



DUAL SPEAKER 15-WATT PERMANENT SYSTEM

Astaire Model JT-30 Crystal Microphone and table stand with 10 ft. cable and plug. For 110-130 Volt, 50-60 cycle AC operation. Shpg. wt. 70 lbs.

PA-107—Complete System less 3-speed Phone Top..... Net **66.50**

PA-108—Complete System with 3-speed Phone Top, Net **83.75**

Either system is available with any other type Mike desired at additional cost.

- ★ 1 Year Guarantee on Amplifier
- ★ Quality Construction Throughout
- ★ G.E. 25 Watt-12" Speakers



30 Watt Portable and Permanent Systems

DUAL SPEAKER 30-WATT PORTABLE SYSTEM

The 30-Watt System is one of our most popular models. Big enough for practically any purpose—used in thousands of school auditoriums, churches, theatres, dance and lecture halls, etc. These systems have been sold to hundreds of dealers. REMEMBER OUR MONEY BACK GUARANTEE AND OUR PRICE!

DUAL SPEAKER-30-WATT PORTABLE SYSTEM. Complete portable system includes: The famous 30-Watt Model PA-26 Amplifier complete with tubes packed with its many features described on next page; Two G.E. 25-watt high quality PM speakers each with 35 feet of cable and plugs; One Astaire Model JT30 crystal microphone with 10 ft. cable and plug and table stand; Handomely designed carrying case. Size 22 1/2" H x 16 1/2" W x 15" D, with compartment, provides a secure place for everything—case covering high quality dark blue fabric. For 110-130 Volt 50-60 cycle AC operation. Shpg. wt. 60 lbs.

PA-109—Complete Portable System less Phone Top..... Net **81.50**

PA-110—Complete System with 3-speed Phone Top Net **98.75**

DUAL SPEAKER 30-WATT PERMANENT SYSTEM

This permanent sound system especially designed for large halls, schools, gymnasiums, etc. Fills a wide variety of requirements for medium power. The Heavy Duty Model PA-25-30 watt amplifier will give you exceptional results and assures top-quality performance under all operating conditions. For low price and our One Year Guarantee makes this system one of the best buys in P.A.

COMPLETE SYSTEM CONSISTS OF: The PA-26 30-watt power amplifier with tubes described on next page; 2 G.E. 25-

watt 12" PM speakers, each speaker with 35 feet of cable and plugs; 1 Astaire Model JT30 crystal Microphone with 10 feet of cable, plug and table stand; 2 handsome wood wall baffles finished in walnut. Easy to install and operate. For 110-130 Volt 50-60 cycle AC. Shpg. wt. 70 lbs.

PA-111—Complets System less Phone Top... Net **74.50**

PA-112—Complete System with 3-speed Phone Top, Net **91.75**

THE GREATEST VALUES in SOUND!



30 WATT MOBILE 6V — 12V — 110V SOUND SYSTEM

PROVIDES COVERAGE OF AREAS UP TO 100,000 SQUARE FEET.

Two sound systems for the price of one, with plenty of power for any job—whether mobile or indoor. Operates from any 6 volt or 12 volt automobile storage battery or from 110-130 volt 60 cycle A.C. at full 30 watts from either supply. Change from battery to A.C. operation merely by changing power cables. Quick change from 6 to 12 volt is accomplished by switch at rear of chassis. Equipped with 3-speed phono top for playing either standard or LP records. Amplifier is unconditionally guaranteed against defects in material and workmanship for one full year... and compare our price!

COMPLETE MOBILE SYSTEM INCLUDES: 30-watt Mobile Amplifier PA-30 with tubes and Phono Top as described on the adjoining page; AC and Battery cables; 2 University Type PH all-metal reflex trumpets complete with 25 watt driver units; 1 Shure Model 505C reluctance microphone with cable; also 70 feet of speaker cable. Nothing else to buy! Operates from 6 or 12 Volt D.C. or 110-130V 60 cycle A.C. Shpg. wt., 145 lbs.

PA-114 Complete System with Tubes and Phono Top..... Net **198.50**

ELECTRIC DRILL ATTACHMENTS

MAKE YOUR DRILL DO A 1000 & 1 JOBS

ALL PURPOSE 1/4" UTILITY DRILL



9.95

- Rugged — Dependable
- Efficient
- 1/4" capacity in steel
- 1/2" in wood
- 1600 RPM no load speed
- Full 90 day Guarantee

Highest possible quality at this lowest possible price. UL and CSA approved. Die cast aluminum housing — trigger switch with "lock" and instant release. Lightweight — easy to handle. Light motor. High efficiency. 1.3 amp motor. For 110-120V. AC/DC. Positive "hand-lit" chuck. Shpg. wt. 4 lbs. **Net 9.95**

FAMOUS 1/4" DRILL WITH JACOBS GEARED CHUCK



- Specially wound Hi-Torque motor.
- Ball-thrust bearing.
- Jacobs keyed chuck.

Powerful, lightweight drill, for home or shop. Capacity: 1/4" in steel, 1/2" in hard wood. Speed at full load: 1,500 r.p.m. Heavy duty trigger switch with "lock" and instant release. With Jacobs Geared key chuck. For 115 volts AC/DC. Shpg. Wt. 4 lbs. **Net \$13.39**

HI SPEED COPE SAW DRILL BIT DRILL-SAW-CUT-REAM



Four jobs with one bit. Use with any electric drill or drill press. Cuts circles, ovals, squares, etc. Withstands severe continuous use. Cuts wood, plastic, bronze, steel, brass, copper, etc. **HD-74 All Purpose Bit Net 1.59**
HD-75 Wood Bit Net 1.59

HI-SPEED DRILL KIT WITH JACOBS GEARED CHUCK



A complete kit for shop or home use. 39 Air-Blower blown sandblast away from pieces for drilling-grinding-polishing-buffing-sanding-mixing. Contains 1600 r.p.m. 3/4" drill with Jacobs geared chuck, 4 bits with holder, rubber disc, buffing disc, polishing bonnet, 12 sanding discs, grinding wheel, adaptor, drill stand, unbreakable plastic chest. UL approved. 110-120V. AC/DC. Shpg. wt. 6 lbs. **Net 16.98**

ROTO AUTOMATIC HACKSAW



- Small, Compact, Powerful
- Nothing To Wear Out!

Fits any 1/2" Electric Drill. Cuts any wood, metal or plastic up to 3/4". There are no gears or bearings to wear out. Saw blade is only exposed working part. Fits in 1 1/4" x 1 1/4" hole. Fits any tool box. Less standard hacksaw blades. Handle covers and protects saw blade when not in use. Shpg. wt. 1 lb. **NET 3.72**

ROTO SANDER ATTACHMENT

Attaches to Roto Hack Saw above. 3" x 5" surface sands with grain. Does every job from rough to fine. Shpg. wt. 1 lb. **Net 2.93**

ROTO HOLESAW



- 4 Different Size Holes With One Hole Saw!
- Cuts Through Any 3/4" Stock... Wood, Plastic Or Metal.

Cuts 1", 1 1/4", 2" and 2 1/2" holes in any 3/4" stock. Works with any pilot drill or drill press. Light, rugged aluminum high-carbon steel. Complete with arbor and 4 saws. Shpg. wt. 1 lb. **NET 3.72**

ARCO SAW WITH DADO-ARBOR

Cuts 2 x 4's in one cut



9.75

New No. 456 "ARCO-SAW" with revolutionary Adjustable "Dado-Arbor" cuts any size groove up to 1" wide by 1" deep at any angle from 0 to 45° — in ONE CUT! Amazing Swivel Action of Arbor cuts large groove with little power, no heavy duty drill is necessary; assures accurate and parallel cuts with no torn or ragged edges. No sanding necessary! "Dado-Arbor" is easily and quickly removed to use the saw for straight or angle cuts. Precision Graduated Depth & Bevel Gages adjust for cuts to 1 1/2" in depth, bevels from 0 to 45°; Adjustable Rip Gage for accurate strips; Adjustable Visual Guide to follow line. 5" (ARCO SAFE CUT) Blade, Strong Safety-Yoke & Worm Drive Clamp; Right Angle Gear Drive with Steel Gears; Self-Lubricating Lifetime Bearings. Fits any 1/2" drill. Complete with "Dado-Arbor", Depth-Bevel-Rip Gages & "Arco Safecut" Blade. With instructions and 90-Day Factory Guarantee. Shipping weight 4 lbs.

- HD-197** — Safecut Blade **Net 9.75**
- HD-115** — Hycarbon Crosscut Blade **Net 1.30**
- HD-117** — Hycarbon Rip Blade **Net 1.30**
- HD-118** — Hycarbon Combination Blade **Net 1.30**

ARCO JIG SAW

With Circle Cutter and Rip Gage



8.95

Cuts perfect circles any size up to 20" diameter; rips accurate widths any size up to 10" wide. An especially desirable home workshop tool because of its versatility. Does work of Jig, Keyhole, Coping, Rip, Crosscut, Band and Hacksaw for intricate patterns. The Jig Saw is simply guided over the cutting line while the Automatic Air-Blower blows sawdust away from blade. Cuts plywood, plastic, wallboard, metal — even lumber up to 2 x 4's! Starts inside holes without boring. Has Right Angle Drive, strong Safety-Yoke and Worm Drive Clamp. Self-lubricating Lifetime Bearings. Blades are easily changed in seconds with ordinary screwdriver. Complete with Circle-Cutter & Rip Gage. Jig Saw Blade, Instructions and 90-day Factory Guarantee. Shipping weight 4 lbs. **Net 8.95**

- HD-196** Jigsaw—Loss Circle Cutter and Rip Gage. Shipping weight 4 lbs. **Net 8.95**
- HD-56** Replacement Blades—Package of 6 Ass'd. **Net 7.50**
- HD-57** **Net 1.46**

POWER BORING BITS

• 8 PIECE SET



1.69

Designed for longer life — faster cutting — another boring in wood — plastics — hardened pressed board. Blades of high grade hardened tool steel. Ground to size for smooth — no burning hole. Faster boring — no clogging — no burning. Interchangeable cutters with a single shank. Quite less power because they develop minimum friction. Fit any 1/4" drill. Size include 3/8", 1/2", 5/8", 3/4", 7/8", and 1". Shpg. wt. 1 lb. **NET 1.69**

HD-181

NEW! IMPROVED MODEL!

Screw-Drill Countersink Kit

2.32



Twist reduces chip clogging

Does 4 operations in one! Countersinks for screws in wood or metal—Drills clean clearance hole—Drills accurate pilot hole—Drills to correct depth, prevents splitting. Do four complete operations in the time it takes to do one. Hole and countersink are always the proper size and depth. Fits all 1/4" chucks. Use in any electric drill—drill press—or hand drill. Kit of 5 contains one each 1/4" x 7/16", 1" x #8, 1 1/4" x #8, 1 1/2" x #10 and 1 3/4" x #12 Screw-Drills. Shpg. Wt. 1/2 lb. **Net 2.32**

HD-93

Net 2.32

NEW VERSAMATIC POWER TOOL

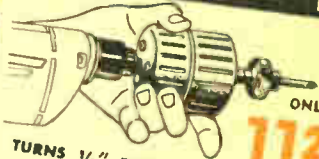

ONLY

11.25

- TURNS 1/4" DRILL INTO HIGH POWER TOOL!
- REVERSES — INCREASES POWER — REDUCES SPEED!

Seven to one speed reduction develops tremendous torque! Hand clutch control for easy, instant stop-start action! Handles largest screws—reverses! Power screw driver—Perfect for concrete or any kind of masonry drilling! Low speed and high power for hole saw attachments! Low speed driver bit—Phillips bit—1/4" socket set adaptor—wrench **HD-193** **Net 11.25**

Thor SPEED TOOLS

THOR HI-SPEED — HI-QUALITY DRILL

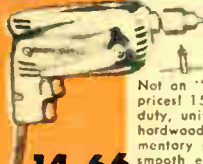

- FAMOUS MODEL 201J 1/4" DRILL
- SPECIALLY WOUND HI-TORQUE MOTOR
- JACOBS GEARED CHUCK WITH KEY
- BALL THRUST BEARING

Not on "off" brand — but famous Thor quality at famous Lafayette prices! 1500 RPM at full load — 2400 — RPM no load speed. Heavy duty, universal, series wound motor. 1/4" capacity in steel — 1/2" in hardwood. Fully UL approved — including 6 ft. SJ cord and momentary switch with locking pin. Self aligning oilless bearings for smooth efficient operation. 9" overall length — for 115V AC/DC. Shpg. wt., 4 1/2 lbs.

14.66

THOR 201-J List 19.95

Net 14.66

THOR HI-POWER 3/8" SPEED DRILL



- HEAVY DUTY — CONTINUOUS OPERATION!
- RATED FULL 3 AMPS!
- 3/8" JACOBS GEARED CHUCK!
- DESIGNED FOR MAINTENANCE AND INSTALLATION!

More power for service work — production lines — mechanics — or anyone requiring a continuous duty drill. 3/8" capacity in steel — 1/2" capacity in hardwood. Highly polished cast aluminum housing — ball thrust bearings — oilless bearings oilless anti-friction bronze. 1000 RPM no load speed — 650 RPM full load speed. Trigger switch with locking pin. 10 ft. 3 conductor SJ cord grounds motor housing. Geared chuck takes shanks up to 3/8". Universal series wound motor. For use on 110-120V AC DC. Shpg. wt., 6 lbs.

25.48

THOR 325 List 32.50

Net 25.48

THOR HEAVY DUTY 1/2" SPEED DRILL



- THE STANDARD FOR SERVICE — CONSTRUCTION — GARAGE — MAINTENANCE!
- CAST-IN FRAME AIR COOLING AND LUBRICATING!
- 1/2" GEARED CHUCK WITH KEY!

The perfect combination of power — rugged construction — lightweight — and ease of handling. Die cast polished aluminum housing. Removable side handle. Capacity 1/2" in steel — 1" in hardwood. Heavy duty radial and end thrust ball bearing on spindle — self aligning bronze bearings elsewhere. 6 ft. 3 conductor SJ cord. UL approved. Trigger switch with locking pin. 650 RPM no load — 425 RPM full load. Heavy duty, universal, series wound motor. 13" overall length. Use on 110-120V AC/DC. Shpg. wt. 12 lbs.

28.95

THOR 40B—List 39.50

NET 28.95

WEN ELECTRIC POWER SAW

A truly universal power saw for the home workshop. Cuts 2x4's easily in seconds! Safe to use, easy to handle. Does the work of a rip saw, a rip saw or a band saw. Operates as coping, crosscut, scroll, hack or keyhole saw. Makes its own starting hole on inside cuts. Saws wood, plastics, metal, composition, hard rubber, etc. Cuts straight lines, curves, circles and intricate designs. Air stream blows sawdust off guide line. Well balanced, light weight. 115V AC-DC 1.6 amp motor. 2650 heavy gauge steel. Wren ute. Length of stroke 3/4". 6 1/2" L x 5" H. 6" UL approved cord. Supplied with 3 assorted blades. Shpg. wt. 4 lbs.

WEN MODEL 505 In lots of 3, Each 19.57

Singly, Each 22.01

BLADES FOR WEN SAW

WEN 50-A-35 —Pkg. of 3 Coarse cutting blades .70

WEN 50-A-36 —Pkg. of 3 Med. cutting blades .70

WEN 50-A-37 —Pkg. of 3 Fine cutting blades 1.26

WEN 50-A-34 —Pkg. of 3 Assorted blades .84



19.57 Each

In lots of 3

Singly,

Each 22.01

WEN SAW TABLE

- MAKES THE WEN 505 SAW YOUR MOST VERSATILE TOOL!
- CUT CIRCLES! MITRE! SCROLL SAW! DOVETAIL!

Precision features not found on any saw table near this price. Saws any angle — rip — cut perfect circles — use as scroll saw — square with perfect accuracy. Make dovetail joints and other deluxe cuts made only on expensive machinery. Table is 5" x 15" x 7 1/2" heavy gauge steel. Wren 505 Saw snaps and locks into place at once. Includes protractor, protractor fence, circle cutting device, jointer and 5 blades. 14 pitch blade for wood — 8 pitch blade for joints — knife blade for leather, rubber, paper, etc. — 32 pitch high temper blade for bakelite, farmica and sheet steel. Shpg. wt., 12 lbs.

WEN 5T1

Net 9.52



14.91

PET PORTABLE SPRAY OUTFIT

- Powered by any 1/4" Electric Drill.

- Compact—Sturdy—Light weight. • Twice-as-larger

This is the newest tool attachment for your 1/4" electric drill! Anyone can do a professional job on furniture—autos—cabinets—equipment. Twin cylinder compressor delivers .5 cu. ft.—25 PSI at 1500 RPM. Adjustable bracket permits any 1/4" drill to serve as power source. Includes adjustable nozzle to handle various liquids—one quart capacity siphon type spray gun threaded for standard mason jars—10 ft. rubber hose—50 lb. capacity air gauge—three adapters to fit practically any air inlet valve—twin cylinder compressor with 0-80PSI pressure regulator. Only 14"x7 1/2"x7 1/2". Shpg. Wt. 8 lbs.

HD-134.....Net 14.91

THOR 15T SPEED SANDER



Here's Our Hot Sander Special

- PROFESSIONAL PERFORMANCE! • MOTOR DRIVEN — 3450 RPM!
- SANDS — SMOOTHS — BUFFS — POLISHES — RUBS!
- USE SHEET OR FREE (WET) ABRASIVES!

Get this new top quality sander for all sanding uses. Here's an orbital motion, motor driven finishing sander (no load speed 3450 RPM) that sands, smooths, buffs, polishes, or rubs with both sheet abrasives or wet (free) abrasives. Sanding area — 4 1/2" x 5 1/8". Features all sealed ball bearings; direct-connected air-cooled motor. Rugged blue hammerlaid cast aluminum body. Handy switch prevents accidental starting. UL approved. Use on 110-120V 60 cycle AC only. Shpg. wt., 7 lbs.

THOR 15T—List 24.95

NET 17.47

THOR 3509—Lambswool polishing pad

NET .85

THOR 5-106—18 sheets assorted sandpaper

NET .85

THOR BENCH SPEED GRINDER



- HUSKY 1 1/2 HORSE POWER MOTOR
- 3450 RPM NO LOAD SPEED

The perfect grinder for the small shop — garage — maintenance man. Twin 4 1/2" x 3/8" wheels. 1 — 60 grit and 1 — 120 grit. 3/8" arbor hole. Light weight die cast aluminum case. Rubber feet for operation anywhere. Can be bolted to bench or service truck. Self aligning oilless bearings. 6 ft. heavy duty cord. 7 1/2" overall length. Blue wrinkle finish. Use on 110-120V. 60 cycle AC only. Shpg. wt., 9 lbs.

THOR 117 List 16.50

Net 12.94

TWIST DRILL SET

Set of 13 high quality chrome vanadium twist drills. Sizes 1/16" to 1/4" by 64ths. Less index. Shpg. Wt. 6 oz. HD-114.....

98c

As above but complete with metal index. Shpg. Wt. 8 oz. HD-113.....

1.59

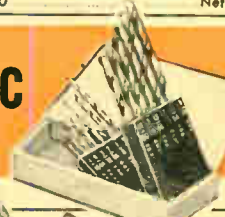

ROTO-TRIM



8.29

Here's the drill attachment you've been looking for. Keep your whole yard neatly trimmed. Converts any 1/4" electric drill into an easy handling-keen cutting Hedge Trimmer. Trims shrubs, hedges and grass easily and smoothly. Rugged steel and aluminum construction. Hardened steel gears and cam. 10" cutting blades designed for maximum efficiency. Light weight—precision balanced for easier handling. Handle turns blade to any angle. Shpg. Wt. 3 lbs.

HD-97

Net 8.29

UNIVERSAL DRILL PRESS

- Converts Elec. Hand Drill To Drill Press



Here is a handy accessory item which acts as a drill stand and converts any 1/4" electric hand-drill into a drill press. Maximum length of travel is 2 1/2". Overall height is 16 1/2". Sturdily constructed. Powerful spring holds drill in place when not in use. Shpg. Wt. 9 lbs.

HD-120.....Net 8.19

SAW-MATIC 8" TILT ARBOR SAW

DOES EVERYTHING

SAWS COSTING

3 TIMES

AS MUCH

CAN DO

A mechanical marvel, this TILT-ARBOR SAW gives fast, accurate, key-hole performance. Blade tilts to 45° cutting angle. You can mitre, bevel or saw any length at any angle, set table and work saw level. Cuts joints, sliding rafters, foam, joints, slots, dados and moldings. Takes any bench saw attachment. Does all types work—resaw rip, level, mitre. Other features include steel safety guard, self-aligning rip fence, large polished stainless blade, accurate tilt scale, adjust to any angle, removable depth gauge, arbor mounted in double self-lubricating bearings. Cuts up to 2 1/2" thick hard or soft wood. Precision built of cast iron. Table size 13" x 14". Cast iron extensions (not supplied) 8" x 14". Shpg. Wt. 55 lbs. List 20.50

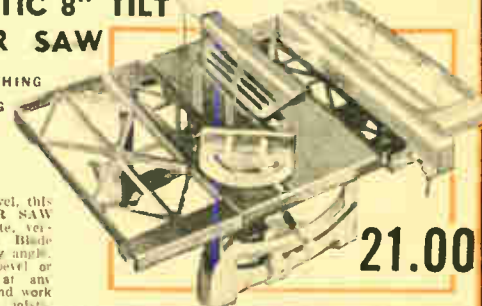

21.00

HD-127.....Net 21.00

ACCESSORIES

HD-128—EXTENSIONS—Wt. 5 lbs.Net 2.95
 HD-129—V Roll and PulleyNet 1.59
 HD-130—Extra 8" Saw BladesNet 1.49
 ML-47—3/4" H.P. 1725 RPM Split Base Motor.Net 17.50

.... SPECIAL TIME & MONEY SAVERS

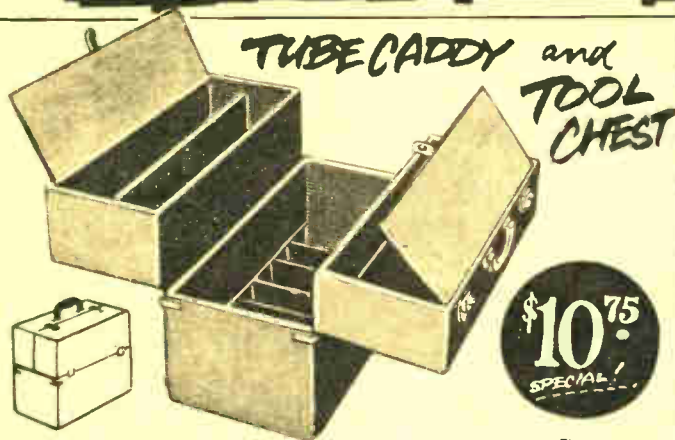

TUBE CADDY and TOOL CHEST

\$10.75
SPECIAL!

Designed with the serviceman in mind. Center section has 6 sections. Three hinged swing-out sections each with its own button-down cover. One top section undivided for larger items, other top section divided lengthwise. Made of heavy wood, with 4 metal braces at hinge corners. Lever-action snap locks. Plastic carrying handle. All hardware nickel plated. Size 16 1/2" L x 13 1/2" H x 8 1/4" W. Covered with tough wear resistant material. Shpg. Wt. 10 lbs.

ML-58

Net 10.75

TV TUBE CADDY 6.75

Here's a real value in a portable caddy. Holds up to 130 tubes. Unique break-away section makes everything quickly available. Has compartment designed for carrying instruments and large tools and a 3 section compartment for smaller tools wire solder, etc. Wood case with plastic coated fabric covering measures 16" W x 12 1/2" H x 8" D. Shpg. wt. 13 lbs.

ML-75.....Net 6.75

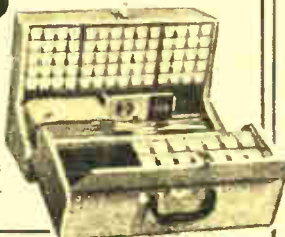

PRECISION SOLDERING INSTRUMENTS



- WORLDS LIGHTEST — ONLY 1/4 OUNCE!
- PRODUCTION — SERVICE — RESEARCH!
- INCOMPARABLE FOR TRANSISTOR WORK!
- ONLY 6" LONG!

Heats in 30 seconds — long life — low voltage element. Prevents damage to small assemblies — pin point heat concentration. Sturdy — no ceramic or mica formers. Particularly recommended for soldering transistors — diodes — r.f. coils — hairpins. — printed circuits — hearing aids — etc. Operate from any 6 volt source including dry cells, wet cells, filament or step down transformer.

TYPE	WATTS	TIPS	DIA.	NET
6A	6	Fixed	1.125"	4.95
6B	6	B	3.32"	4.95
9-6	8.3	A	5.32"	4.95
11*	10	A	5.32"	6.95
12-6	12	C	3.16"	4.95

* High temperature model 400 C.

TIPS—Special Alloy—nickel plated

TYPE A—5/32" for Model 6A, 9

and 11

TYPE B—3/32" for Model 6A and 9

and 11

TYPE C—3/16" for Model 12

Net .40

Net .40

Net .50



LENK LP TORCH

- INSTANT LIGHTING — INSTANT HEAT!
- THROW-AWAY FUEL CONTAINER!
- SELF SEALING SAFETY VALVE!

An all purpose liquefied petroleum torch. Does regular soldering — sweat fittings — silver soldering — remove finishes, paints and putty. Self sealing valve permits safe removal of torch head. Lights instantly — no priming, no waiting. Clean — sootless — odorless flame. More than 2200° F. Shpg. wt., 1 1/2 lbs.

LENK 295 LP — SPECIAL! Two burners — needle point and blast! Complete with two tanks of fuel. No extras to buy! Shpg. wt. 3 lbs.

LENK 77 LP — SPECIAL! Two burners — needle point and blast! Complete with two tanks of fuel. No extras to buy! Shpg. wt. 3 lbs.

LENK 77 LP REPLACEMENT FUEL TANK — for all Lenk LP Torches. Shpg. wt. 1 lb.

LENK 77-1

NET 3.40

NET 3.40

NET 5.9

FAMOUS WELLER SOLDERING IRONS



LATEST WELLER-SOLDER GUNS
New High Wattage Guns—These latest model guns have everything! Increased wattage—dual spalltites—rugged plastic case—featherweight balances. Come equipped with cord, plug and one tip. 110-120 volts AC 60 cycles.

PROFESSIONAL SOLDER GUNS STANDARD DUTY GUNS

Model S400. Single-heat type. 135 watts. Shpg. wt. 3 lbs.	List \$12.15. NET	8.77
Lots of 3, EACH		7.89
Model D440. Dual-heat type. 100-150 watts. Shpg. wt. 3 lbs.	List \$14.90. NET	10.73
Lots of 3, EACH		9.65

HEAVY-DUTY GUNS

MODEL S-500. Single-heat type. 250 watts. Shpg. wt. 3 1/2 lbs.	List \$11.50. NET	9.75
Lots of 3, EACH		8.77
MODEL D-550. Dual-heat type. 200-275 watts. Shpg. wt. 3 1/2 lbs.	List \$14.25. NET	11.71
Lots of 3, EACH		10.53

REPLACEMENT TIPS

No. 7135. For light-duty models S400 and D440. PKG. OF 2 28¢
No. 7258. For models WS-200, WD-250, S-500 and D-550. PKG. OF 2 38¢
No. 7300. Chisel tip. For use only in older models S-107 and D-207. Not interchangeable with tips used in guns listed above. PKG. OF 2 28¢

WELLER 8100-K SOLDERING KIT



5.83

A complete soldering set. Weller soldering gun delivers over 100 watts and heats in 5 seconds. Gun has trigger switch control and dual spalltites to illuminate work. Uses long life inexpensive replaceable tips. Kit also includes soldering aid to make tight wire twist and help open old soldered joints, and brush to insure clean connections. Shpg. wt. 4 lbs.

WELLER 8100-K.....List 7.95.....Net 5.83



WELLER SOLDERING KIT

Here's everything you need for hundreds of homecraft and hobby jobs. Does all the many electrical soldering jobs around the home and shop—plus plenty of heat for sheet metal—pot—pans—can—etc. Cut plastic files—repair plastic toys. Kit includes 250 watt instant heat—dual spalltite Weller gun—ample supply of Kester solder—soldering tip—smoothing tip—cutting tip—tip interchange wrench—two instruction booklets—sturdy metal case for convenient storage. Shpg. Wt. 5 lbs.

WELLER 8250-AK.....Net 10.99

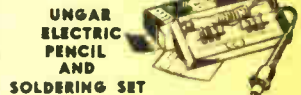

UNGAR ELECTRIC PENCIL AND SOLDERING SET

One complete set for home craftsmen and hobbyists. Set contains six interchangeable tips; four for burning and embossing of wood, plastic, leather, cork, etc., and two for soldering. Five sheets of embossing foil, abrasive cloth, complete set of instructions for working wood, plastic, leather and cork. Illustrated catalog of plaques and projects. Heating unit is UL approved and guaranteed for 10,000 hours.

MODEL 217.....EACH 1.96

Lots of 6, ea. 1.59 Lots of 12, ea. 1.47

SPECIAL SOLDERING KIT

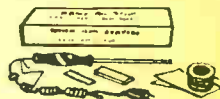

The "Mighty Mite" soldering kit — does the work of many larger irons. Includes 35 watt iron — steel scraper — pool of solder — iron stand — sandpaper — soldering instructions and date. Shpg. wt. 1 lb.

HD-198.....Net 1.10



Clear vinyl plastic tool pouch with snap closure. 9" x 6" size — to hold those few most used tools. Protects pockets — protects tools. Shpg. wt. 8 oz.

HD-199.....In lots of 10, Ea. .39

Singly, Each .44

WELLER POWER SANDER

10.99



- Positive Straight Line Action Sands with The Grain
- Large Sanding Area Full 25 sq. inch
- Powerful High Speed Cool Motor
- 14,400 Strokes Per Minute

Power-packed reciprocating type motor in easy-grip case only 2 1/2" high with push-button on-off fingertip control. No torque, bucking or twisting. Positive straightline action. Tension-lock paper holders. Rubber insulators between motor and housing minimizes noise. 25 sq. in. sanding area. Complete with 8 ft. cord, 6 sheets essl sandpaper and polishing cloth. Shpg. Wt. 3 1/2 lbs.

WELLER 700

Net 10.99

UNGAR SOLDERING PENCILS



Latest model. Check these improvements: Cooler handle of molded plastic. Perfect balance. Form fit cork grip. Spring action rivet for positive contact. Ceramic insulation for double safety. Extra-flexible cord. 7" overall length.

MODEL 776, Cord, Handle Only.....1.10¢

Lots of 10.....each 89¢

REPLACEMENT TIPS

New "Elkato Tiplets". Super versatility — greater economy! You no longer have to discard the heating unit—it can be used with tip after tip. Threaded "Tiplets" screw into heating unit. Standard element and tip are 20 watts. "Extra hot"—37.5 watts. Heat to 400° in 60 seconds.

Standard Tips

Fig.	Type	Descrip.	Ea.	10, Ea.
F	539	Standard Chisel	98¢	79¢
E	1236*	Pyramid Chisel	1.18	96¢
F	1237*	Chisel		

* "Tiplets" and Heating Units

B	331	Pencil	16¢	13¢
A	333	Chisel	98¢	79¢
D	535	Hi. Unit	98¢	79¢
D	1235*	Hi. Unit	1.18	96¢

New 776 Handle and 536 Tip.....2.08

Lots of 10.....1.68

New 776 Handle and HI Heat.....2.28

1234 Tip.....1.85

Lots of 10.....1.85

UNGAR SUPER HI-HEAT TIPS

850° and 1,000° tip temperature—only 6 1/2 watt! Specially engineered for Production and Heavy Duty. Machined from Tantalum-Copper with special pure silver and iron plating.

Fig.	Type	Descrip.	Ea.	10, Ea.
E	4038	Chisel	1.25	1.91
D	4030	Heat Unit	2.85	1.91
F	4036	Pyramid	1.35	1.91
E	4039	Heavy Chisel	2.35	1.91

...LAFAYETTES *Leading Tool Values!!!*

HANDY VERSATILE PLIERS

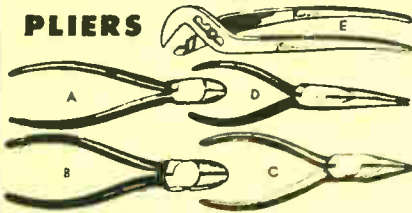

Precision made of finest drop forged tool steel. Ground and polished heads.

No.	Type	Description	Price
HD-48	A	4 1/2" Diagonal Cutters	.69
HD-49	B	6 1/4" Diagonal Cutters	.89
HD-50	C	4 1/2" Stubby Side Cutters	.69
HD-51	D	8" Long Nose Side Cutters	.99
HD-52	E	8 1/2" Water Pump Pliers	.79

Complete set of above pliers.

HD-53..... ONLY 3.65

69¢ 6 PIECE MAGNETIC SCREW DRIVER SET



Five interchangeable — hardened and tempered — tool steel blades; unbreakable, shockproof, chuck-type amber handle. Consists of: 1—4 x 1/8" blade, 1—4 x 1/4" blade, 1—6 x 1/4" blade, 1—4" #2 Phillips head, 1—4" #2 Phillips head, 1—amber handle with chuck. Shpg. Wt. 1 lb.

Stock No. HD-10. Complete with plastic case 69¢

7-PIECE SUPER NUT-DRIVER SET

Most popular socket sizes—polished, hardened steel detachable shafts. Plastic handle with precision clutch. Contains: 1—A hex nut shaft, 1—1/4" hex nut shaft, 1—5/16" hex nut shaft, 1—11/32" hex nut shaft, 1—3/8" hex nut shaft, 1—7/16" hex nut shaft, 1—amber handle with chuck. Shpg. Wt. 2 lbs.



Stock No. HD-14 1.49



6 PIECE RATCHET SCREW DRIVER SET

89¢

Threeway ratchet with brass gear mechanism. Five interchangeable fully polished, hardened and tempered tool steel blades. Unbreakable, shockproof, non-inflammable amber handle. Consists of: 1—3/8 x 3/4 cabinet, 1—3/8 x 1/2 cabinet, 1—5/16 x 1/2 mechanic, 1—Phillips #1 3/8 x 3/16, 1—Phillips #2 4/8 x 3/4, 1—amber ratchet handle with chuck. In plastic roll up kit. Shpg. Wt. 1 lb.

HD-158..... Net 89¢

10 PIECE NUT AND SCREW DRIVER SET



Fully polished, hardened, tempered, tool steel blades and hex-drivers fine chrome plated for long life. Six nut drivers—3/16", 1/4", 5/16", 11/32", 3/8", 7/16". Three screw driver blades—8" x 3/8", 3 1/2" x 3/8", Phillips #2 3/8" x 3/4". Unbreakable, shockproof, non-inflammable amber handle with danged chuck. Complete with heavy plastic roll up kit. Shpg. Wt. 1 lb.

HD-160..... Net 1.59

ADJUSTABLE WRENCHES



Malleable steel, hardened jaws, polished nose.

HD-43.	4 1/2"	NET 55¢ ea.
HD-44.	6 1/2"	NET 63¢ ea.
HD-45.	8"	NET 88¢ ea.
HD-193	10"	Net 98¢ ea.
HD-46.	Set of 4	NET 2.69

ADJUSTABLE COUNTERSINK — PILOT DRILL



- COUNTERSINK — COUNTERBORES — DRILLS
- FOR EVERY STANDARD SCREW LENGTH
- FOR POWER OR HAND TOOLS

Adjustable drill for hand and power tools. Pre-drills a precision hole — countersinks and counter bores in one simple operation. Stops automatically at correct depth. Fully adjustable thread depth, shank depth, countersink and counter bore. Speeds assembly and prevents splitting. Use in any electric drill or hand drill. Cuts in wood — plastic — fibre. Shpg. wt., 8 oz.

HD-206	#6	Net .74
HD-207	#8	Net .74
HD-208	#10	Net .74
HD-209	#12	Net .74
HD-210	Set of 3 #8, #10, #12	Net 1.97

HEAVY DUTY TUBULAR HACKSAW



- REGULAR \$3.00 LIST

Fine quality hacksaw frame. Adjusts for 8" — 10" — 12" blade. Die cast alloy hand contoured handle. Thumb rest for firm grip and comfort. Chromium plated tubular steel for strength. Shpg. wt. 2 lbs.

HD-211		Net 1.35
HD-212	10" Blade 24 teeth per in.	Doz. .59
HD-213	12" Blade 24 teeth per in.	Doz. .69

29 PIECE DRILL SET AND STAND

- CHROME VANADIUM TWIST DRILLS
- PRECISION GROUND — HARDENED — SHARPENED
- 1/16" to 1/2" by 64ths

6.89



A superior grade of chrome vanadium twist drills. Full jobbers length. Will give long lasting use under the most rugged conditions. Full range of sizes. 1/16th to 1/2" by 64th. Convenient metal stand, each receptacle clearly marked. Shpg. wt., 4 lbs.

HD-214..... Net 6.89

VERNIER SLIDING CALIPER

95¢



Sharp pointed projections for accurate dividing, scribing, etc. Lock nut insures against errors caused by sliding gauge. Rule graduated in 16th and 32nds plus 5" depth gauge. Precision-made. Shpg. wt., 1 lb.

HD-221..... Net .95

HANDY WARDING FILE SET



- 6 INDIVIDUAL FILES
- SPECIAL STEEL-DEEP CUT-HARDWOOD HANDLES

First quality German made file set. Perfect for shop — home — hobby work. Kit consists of flat, half round, triangular, square, round and taper files. All with individual hardwood handles. Sturdy plastic pocket case included. Shpg. wt., 1/2 lb.

HD-215..... Net 1.05

PLASTIC ELECTRICAL TAPE

- 2 — 30 FT. ROLLS FOR 69¢!

Guaranteed first quality. Resist effects of acid — water — alkali and abrasion. Hi-dielectric strength. Use to wrap tool handles for insulation and comfort. 3/4" wide.

HD-216..... 2 Rolls for 69¢

FOLDING WORK BENCH AND CABINET



- PERFECT FOR THE CROWDED WORK-SHOPI
- PRICED LOWER THAN EVER!
- USE AS HIDE-A-WAY HOBBY CENTER!

23.95

Truly compact home workshop — fits on back of door — against wall — save space in garage — apartments — or crowded workshop. Measures 21 1/4" x 35 1/4" x 6". Door lets down to form work table 21 1/4" wide by 35 1/4" long. Surface with tough, tempered masonite. All steel construction. Perforated back board and hooks for hanging all your tools. Includes built-in gooseneck lamp — electrical outlet — line cord for AC — steel hooks — mounting hardware. Less tools. Blue gray finish. Shpg. wt., 50 lbs.

HD-217..... Net 23.95

LENK INSTANT FIRE EXTINGUISHER



- YOU CAN'T AFFORD TO BE WITHOUT ONE!

Extinguishes all types of fires safely and quickly. Electrical — oil — grease — etc. A must in the shop — home — auto — boat — camp — office. Full control valve — turns on and off. Includes mounting bracket. Shpg. wt. 2 lbs.

Lenk 72..... Net 1.28

MAGNAGRIP CABINET LATCH

- POSITIVE — QUIET — SECURE!
- USE ON HI-FI CABINETS AND CONSOLES!



For cabinets — doors — gates — screens. Use in workshop — kitchen — garage — den — any place you have a door — requires a simple, positive, quiet latch. Magnetism lasts a lifetime. Simple to install — costs no more than old fashioned friction catches. Shpg. wt., 6 ozs.

HD-218..... Set of 3 — Net .79
Singly, Each .29

TRI-TAP TOOL



1.95

- SERVICEMEN — CRAFTSMEN — MECHANICS
- ONE TOOL TAPS THREE SIZE THREADS
- 6/32 — 8/32 — 10/32

Cleans — cuts — taps any of the three most common thread sizes used in electronic and electrical work. Three sizes on one tool — saves time — eliminates searching. Hardness is 59 to 60 Rockwell on scale C material. Shpg. wt., 1 lb.

HD-219..... Net 1.95

PIN-UP WORKSHOP UNIT

- THE MOST CONVENIENT TOOL STORAGE!
- 12 SQ. FEET OF STORAGE SPACE!
- SET UP IN SHOP — GARAGE — HOME!



5.87

One handy package provides approximately 12 square feet of storage space. Four squares of tempered perforated hard-board for complete flexibility of design in hanging. 62 special fixtures plus small parts — jars — shelf brackets — screwdriver holder — exclusively designed for holding the largest variety of tools. Mounts easily on any flat surface. Pre-coated hardboard is 1/4" thick — may be painted to suit. Unique self-locking fixtures can't "give" or twist out. Supplied complete with fixtures — mounting screws — spacers — and instructions. Shpg. wt., 1.5 lbs.

HD-220..... Net 5.87

LAFAYETTE can save you up to 50% on **DRAFTING** and **DRAWING** Essentials

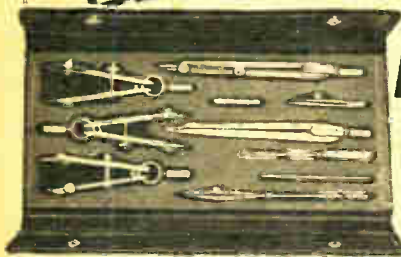

DRAFTING SET
new!
2.35

Made in Germany of hard rolled, nickel plated brass. All instruments are nested in a fitted, velvet lined case. Contains three side wheel $3\frac{3}{4}$ " bow instruments—one a divider, one a pencil and one a pen. All have reversible needle point. $5\frac{1}{4}$ " compass with pen and pencil parts—and lengthening bar. $5\frac{1}{4}$ " divider with straightening device. 5" ruling pen. Extra handle for use with pen and pencil parts. Capsule with extra leads. This is one of the finest values Lafayette has ever offered. Perfect for schools, labs, industrial or wherever precision drawing sets are used. Your money back if you do not agree that this set is worth twice our low, low price!

DRAFTING ENGINEERS DRAFTSMEN ARTISTS

THIS IS IT!!

- ECONOMY • PRECISION • RUGGED
- COMPACT • VERSATILE • QUALITY



2.70

Approved by top engineers, designers, draftsmen, etc. Requires no special training to operate. Clamps to drawing board or sketch pad. Designed to operate on an 11" x 17" board — folds like a jackknife — slips into drawer or briefcase. Eliminates clutter of T-square, ruler, protractor, triangles. All aluminum — jet black with white filled numbers — machine calibrated to $\pm .0005$ of an inch! Sturdily constructed to withstand normal hard usage. 101 practical uses in work — studies — hobbies. For laying out chassis — diagrams — sketches — design detail — surveys — etc. Costs far less than other drafting machines. Complete with instructions. Shpg. wt., 1 lb.

F-221

Net 2.70



PROFESSIONAL GIANT BOW DRAFTING SET

- 6" Size with Center Wheel Adjustment
- Finely Balanced—Professional Type

Professional quality utility set in a fitted, velvet lined case. Made in Western Germany of nickel plated, hard-rolled brass. 6" giant bow has preferred center wheel adjustment. Makes circles from $\frac{1}{8}$ " to over 10" in diameter. Set includes 6" giant bow, interchangeable pen and pencil parts, extra needle for using bow as divider, handle for use with pen and pencil parts, lead, lead box and repair parts. Quality features make this set worth many times our low price—You must agree—or your money back!

F-44

Net 2.95

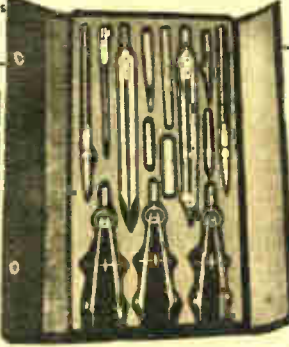

A fine set of imported nickel plated brass instruments priced far below the usual price for this quality. Contains $6\frac{1}{2}$ " self-centering compass, one leg knuckle joint with divider, pencil, pen parts and lengthening bar; $6\frac{1}{4}$ " self-centering divider; spring bow divider $4\frac{1}{2}$ ", center wheel adjustment with interchangeable needle points; spring bow pencil and spring bow pen, both $4\frac{1}{4}$ " with center wheel adjustment and interchangeable needle point; two $5\frac{3}{4}$ " ruling pens; extra handle for pen and pencil parts; adjustment tool; lead case and leads; end spare parts kit, all in velvet lined snap closing case. Shpg. Wt. $1\frac{1}{2}$ lbs.

F-65

Net 5.95

"DIAL-A-MATIC" ADDING MACHINE



ADDS UP TO 99,999 — SUBTRACTS — MULTIPLIES.
Fast—accurate—precision engineered. Moving parts made of DuPont Nylon. Just dial your numbers—read your answers! Great for general daily calculations—small business—and homework. Fits pocket or purse—mechanically guaranteed. With dialing stylus. Shpg. wt., $\frac{1}{2}$ lb.

F-100

Lots of 3, each 1.35
Singly, each 1.50

LETTERING GUIDE SET



Made of transparent plastic that's pliable yet rigid—a must for good lettering. Simple to use with either sharp pencil or ink. Each guide has undercut to prevent ink smears when moved. Each has complete alphabet, all numbers plus commonly used signs. Most letters formed with one operation. Set consists of six guides. Sizes $\frac{1}{8}$ ", $3/16$ ", $1/4$ ", $5/16$ ", $3/8$ " and $1/2$ ". Shpg. Wt. $\frac{1}{2}$ lb.

F-78—Complete Set.....

Net 5.98

INDIVIDUAL GUIDES					
No.	Size	Each	No.	Size	Each
F-79	$\frac{1}{8}$ "	69c	F-82	$\frac{1}{4}$ "	1.19
F-80	$3/16$ "	85c	F-83	$5/16$ "	1.35
F-81	$1/4$ "	98c	F-84	$3/8$ "	1.65

Sale!

LETTERING PEN

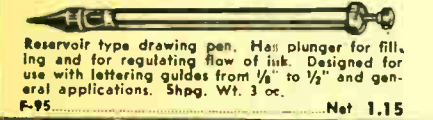

Reservoir type drawing pen. Has plunger for filling and for regulating flow of ink. Designed for use with lettering guides from $\frac{1}{8}$ " to $\frac{1}{2}$ " and general applications. Shpg. Wt. 3 oz.

F-95

Net 1.15

GIANT BOW BEAM COMPASS

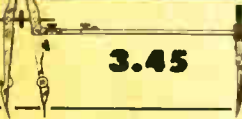

3.45

- Telescoping extension bar.
- Draws circles up to 28" in diameter.
- Center wheel adjustment.

Made in Germany of nickel plated, cold rolled brass. Divider is 6" long—has knuckle joint—interchangeable pen and pencil parts—telescoping beam—variable needle point—center wheel acts as micrometer. Makes circles from $\frac{1}{8}$ " to 28" with extension bar. A professional instrument with a wide range of utility.

F-116

Net 3.45

INDOOR OUTDOOR THERMOMETER

- EASY TO READ.
- MAGNIFYING CASE.
- ACCURACY GUARANTEED.

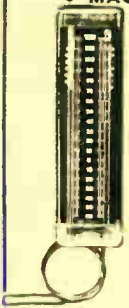

Instant comparison of room and outdoor temperature. "Inside" location ideal for quick, easy reading. Tells at once if air-conditioner or furnace is operating properly. Magnifying case and single centered scale permits easy reading from any position or distance in the room. Guaranteed accuracy as specified by the U. S. Bureau of Standards. No moving parts to become worn. Easily, quickly installed. Attractive charcoal gray background—white scale—red fluid tubes. Complete with instructions and mounting hardware.

F-166

Net 2.79

8" ADJUSTABLE TRIANGLE

Handiest device ever! Transparent plastic. Trace any angle from 0 to 90 degrees. Inner row of graduations on arc give angle, outer row give complementary angle. Has four openings for drawing circles $\frac{1}{2}$ ", $\frac{3}{4}$ ", 1" and $1\frac{1}{4}$ " diam. Tapered holes $\frac{1}{4}$ " apart on two sides to divide any line into equal parts by swinging angle. Useful for cross hatching, architectural stairway drawings, speeds up letter spacing. No protrusions to tear tracing paper. Shpg Wt. 6 oz.

F-77

Net 1.98

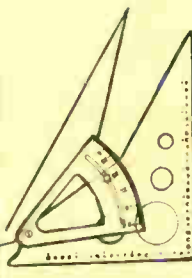

1.98

ILLUMINATED MAGNIFIER

- 5X MAGNIFICATION — 2" FIELD
- REGULAR 10.95 VALUE!



A fine, fixed-focus illuminated magnifier — magnifies work 5 times. Field of vision is 2" at $1\frac{1}{2}$ " working distance. Unlimited usage in industry — shop — hobbies. For checking tool and dies — castings — forgings — welds — etc. Inspection of meter movements — fine soldering electronic repairs. Magnified area easily accessible through cut out invaluable in hobbies such as stamp or coin collecting, photography, entomology — mineralogy — etc. Excellent map reader. Completely portable — uses two No. 2 cells for power. Weight $\frac{3}{4}$ lbs., length $8\frac{1}{2}$ " overall. Shpg. wt. $1\frac{1}{2}$ lbs.

F-193

Net 4.49

MICROBE HUNTERS! YOU SAVE IMPORTERS PROFITS

LAFAYETTE IMPORTS DIRECT



3 LENS TURRET MICROSCOPE

100X-200X-300X
At a Microscopic Price

We made a deal with a bio importer. He needed cash—Fast! So he came straight to big-buying Lafayette—made us a hard-to-believe offer—and we closed the deal then and there! You get the lowest prices ever on a truly fine instrument—precision built for accuracy and long lasting service. Triple position turret holds 3 achromatic color-corrected objectives for magnification of 100X, 200X and 300X power! Heavy base and stand—inclines through 90°. Dual knob focusing by rack and pinion. Adjustable plano sub-stage mirror. High grade microspices used throughout! Complete with fitted wood-carrying case and slides. Shpg. Wt. 4½ lbs.

F-10.....NET 4.75

QUADRUPLE TURRET REVOLVING MICROSCOPE

7.45

500 Power

8 ¼" HIGH

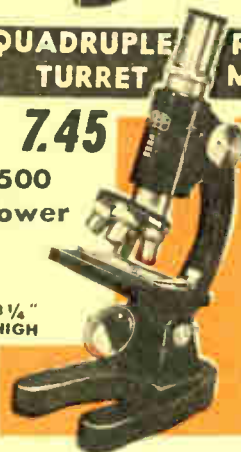

NEVER BEFORE OFFERED TO THIS MARKET!

RANGE OF 500X-300X-150X-75X! EXCLUSIVELY LAFAYETTES AT THIS HISTORY MAKING PRICE!

CHECK THESE FEATURES

One of the greatest optical values Lafayette has ever offered! New four lens turret offers greater range and facilitates micro-observation. Turret holds four achromatic objective lenses giving range of 75 x 150 x 300 x and 500 x! All metal construction—heavy horseshoe base. Black satin professional finish — high lighted with brushed chrome. Finely machined rack and pinion gear, dual knob focusing. Ocular lens is the widely accepted Huygenian type. Professional type inclination joint — inclines to 90°. Substage plano mirror. The most practical instrument possible for the high school student, amateur biologist and botanist, hobbyists, or as inexpensive second instrument for the professional. Backed by Lafayette's famous "Moneyback" guarantee! Includes dove-tailed wooden carrying case and sample slides. Shpg. wt. 5 lbs.

F-168.....NET 7.45

MECHANICAL SLIDE HOLDER

- CENTERS SUBJECT MECHANICALLY.
- SAVE TIME—NO FUMBLING.
- PREVENTS "OVERSHOOT" OF SUBJECT.

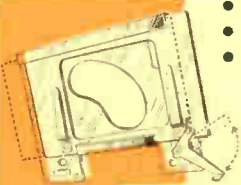

1.50

An ingenious, inexpensive device to aid in centering—positioning—and shifting slide mounted subjects. Designed to work with our F-10 and F-43 microscopes—or others having no larger stages. Made entirely of plated brass. Will accommodate slides up to 1"x3". An indispensable accessory for the careful study of mounted micro-subjects.

F-122.....Net 1.50

MICROSCOPE SLIDE KIT

Compartmentalized fine wood hinged case with individual slots for slides. Contains 25 glass slides 3" x 1", 25 cover glasses, and bottle with ample supply of balsam fixative. Shpg. Wt. 1¼ lbs.

F-89.....Net 1.59

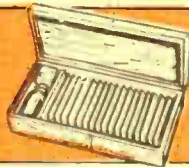

HUNTING WITH THE MICROSCOPE

• NEW EDITION

Guide for beginners and advanced users of microscopes. How the microscope works. How to prepare and study cultures — set up a microscopic zoo and garden — grow micro organism — perform micro surgery. Profusely illustrated with photographs and drawings. 14 chapters of easy-to-read, highly informative text.

F-222—136 pages 5½"x8"

Net .89

900X LABORATORY MICROSCOPE

- The most practical instrument for Botany—Zoology—Pharmacology — Bacteriology — and general Laboratory use.
- Highly efficient—exceptional construction.
- Huygenian Oculars — Achromatic Objectives.

Only Lafayette's policy of importing direct makes it possible to offer an instrument of this quality at this price. Mechanically and optically one of the finest instruments Lafayette has ever offered. A truly fine dry system microscope suitable for a wide range of laboratory—professional—and college use. Dual-knob monocular tube—spiral rack and pinion focusing mechanism. Revolving disc substage diaphragm. Triple revolving nosepiece with achromatic objectives of 5X—10X—and 60X. Two Huygenian eyepieces of 10X and 15X give a range of 50X—100X—150X—600X and 900X. Plano-concave reflex mirror 1½" in diameter. Bending device permits 90° inclination. Approx. 11" high retracted. Complete with fitted hardwood case and slides. Shpg. Wt. 8 lbs.

F-107.....NET 49.50



49.50

PRECISION TRIPLE-TURRET MICROSCOPE

- 100X — 150X — 200X — 300X — 400X — 600X!
- Interchangeable Huygenian Eye-pieces!
- Achromatic Micro-optics!
- Revolving Disc Diaphragm!
- All Metal Construction!



The most popular all around instrument available. A high grade dry system microscope suitable for schools, colleges, biologists and hobbyists. Monocular tube design focused by dual knob, fine rack and pinion gear. Fixed square stage is 3¼" x 2¼". Revolving disc type substage diaphragm for light control. Two sided plano-concave mirror 1½" in diameter. Achromatic objectives of 10X—20X—40X. Interchangeable Huygenian eyepieces of 10X and 15X. Heavy cast horseshoe base—all solid metal construction. Inclines up to 90°. Height is 9½" fully retracted. Complete with fitted wood case and sample slides. Shpg. Wt. 7 lbs.

F-106.....NET 17.95

PREPARED MICROSCOPE SLIDES

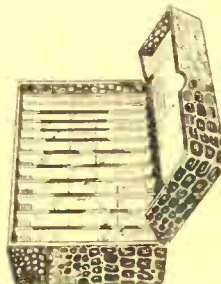

- SPECIALLY SELECTED MICRO-SUBJECTS.
- ADD TO THE ENJOYMENT OF YOUR MICROSCOPE.
- PROFESSIONALLY PREPARED.

Specially selected slides of universal interest. Carefully prepared—cleaned, dissected, embalmed, stained, mounted and covered. Slides are professional size. Set includes 12 prepared slides and slotted, covered box for filing and storing.

F-123—Parts of Insects	Net 1.39
F-124—Spiders and Disease Carriers	Net 1.39
F-125—Tiny Creatures found around House	Net 1.39
F-126—Sea Life	Net 1.39
*F-128—Structure of Blood	Net 1.15
F-130—Life cycle of Insects	Net 1.39
F-131—Bacteria	Net 1.79
F-132—Pond, Marsh and Sea Life, Plankton	Net 1.59
F-134—Micro-Animals	Net 1.29
F-135—Micro-Organisms	Net 1.29
*F-136—Substance of Cells	Net .89
*—Set of 6 slides.	

**EXCLUSIVE
OPTICAL VALUES**

IMPORTED TO SAVE YOU MONEY



8.39

A WORKING SCALE MODEL

GIANT

MT. PALOMAR TELESCOPE

- BAUSCH & LOMB REFLECTOR LENS
- SEE THE MOON'S CRATERS — JUPITER — SATURN

Working scale model of the 200 inch Mt. Palomar telescope. Bausch and Lomb prime focus reflector lens — optically ground and polished. Rigid design — sturdy operating controls to better enable the young astronomer to study the Moon — Saturn — Jupiter — and all the wonders of the night sky. More than a toy — an accurate, powerful optical instrument. Educational — interesting — and fun to use! A natural for today's space minded youngsters — suitable for the amateur astronomer. Complete kit including easy to follow instructions and illustrated "Star Guide". Shpg. wt. 5 lbs.

F-223 List 11.95 Net 8.39
Fully assembled — Ready to use. Exactly as described above but completely assembled. Shpg. wt. 5 lbs.
F-224 List 14.95 Net 10.49

NEW 30 POWER 60mm SPOTTING SCOPE

- Binocular type focusing! • Prismatic Lens system!
- All Metal Construction Weighs only 11 ozs.
- 12 1/2" long!
- Coated optics!



Complete with tripod and Case!

17.95

Not just another spotting scope — but a prismatic telescope using the same fine features as expensive binoculars! Fine prismatic lens systems eliminates distortion, gives sharper detailed definition and a greater field of view. Field of view is 85 feet at 1000 yds! Both front and rear optics are coated. High relative brilliance due to great 60mm (almost 3 in.!) objective lens. Threaded metal dust cover screws into position over front lens when not in use. Exceptionally small and light — weighs only 1 1/2 lbs. including metal tripod! Tripod has adjustable tension mount which permits sighting up, down, across or at any angle. The perfect companion for shooting — hunting — viewing — naturalists — and hobbyists. Comes equipped with 1 1/2" tripod and mount and zippered leather carrying case for both scope and tripod. Shpg. wt. 2 1/2 lbs.

F-149.....NET 17.95

SALE!

REFRACTING ASTRONOMICAL TELESCOPE

IMPORTED WITH TRIPOD AND FITTED WOODEN CASE

- Three Eyepieces—40X, 64X, 89X
- 800-mm Focal Length
- 2 1/2" Objective Lens
- Regularly \$125.00

Professional instrument for the amateur astronomer. Fully corrected and coated lenses for maximum brilliance and clarity. White enameled duraluminum tube. Moving parts of heavily chrome plated brass. Fine toothed rack and pinion focusing. Includes 4X cross hair view finder; 3 eyepieces—20 mm, 12.5 mm and 9 mm, erecting prism for terrestrial viewing, star diagonal for convenient right angle viewing. Revolving power 1.93. Fork type altazimuth mounting with tension adjustments. Objective lens is 60 mm in diameter—large dew caps prevent condensation on lens and restricts stray light. Three section collapsible wooden tripod has chain brace. Complete in compact, fitted wooden cabinet. Weight of telescope, tripod and case, approx. 8 lbs. Total shipping weight 25 lbs.

F-102—Complete set Net 69.50



NEW REDUCED PRICE \$69.50

30 POWER TELESCOPE

- Weighs only 8 ounces!
- All metal—chrome trimmed!
- With plush-lined leather case!



5.95

Precision machined body. Hand ground, hard coated, achromatic lenses. Sharp, clear, brilliant images in the same manner as fine binoculars. Used in hunting—sports—vacationing. For long distance or close up views. Brings objects 30 times closer! Highly polished plated tubes for smooth, easy sliding focusing. Collapses to 7"—extends to 14 1/2". Not a cheaply made toy telescope. But one of Lafayette's finest optical bargains. As always you must be satisfied—or return for immediate refund. Shpg. Wt. 2 lbs.

F-59.....Net 5.95

30X ALL PURPOSE TELESCOPE

New

- WITH TRIPOD AND WOODEN CASE
- 40mm COATED ACHROMATIC OBJECTIVE!
- 59' FIELD AT 1000 YDS.!
- BODY OF DURALUMINUM AND BRASS!



11.95

See the craters on the moon! Watch planes—ships—birds and animals. Spot .22 calibre bullet holes at 200 yds.!

Just in time for vacationists—hikers—campers—boating—bird watching—any of the many outdoor activities. A typical Lafayette buy! Full two feet long—closed—27 1/2" extended. Achromatic coated objective is 40mm in diameter—clear aperture is 38mm—or 1 1/2". Body diameter is 1 1/4". Lens erecting system gives upright image. Focuses from 40 feet to infinity. Adjustable horizontal swing tension and adjustable azimuth tension knob. Can be used with camera tripod. Smooth sliding draw tube focusing—with coated ocular lens. Complete with 1 1/2" tripod—bracket—Shpg. Wt. 5 lbs.

F-139.....Net 11.95

HAND SIGHTING LEVEL



1.98

- Rack And Pinion Focusing
- New Brass Bound Army Type!
- Requires No Complicated Calculations!

Indispensable to home owner—students—engineers—gardeners—plumbers—masons. Fits in the palm of your hand and sighted like a telescope. Enables user to quickly and accurately project a level line of sight. Replaces expensive surveying equipment for laying out garden—fences—patios—drains—ditches—piers—roads—etc. So simple and accurate, anyone can use it. Nicely finished in baked on enamel—brass bound. Directions included with each instrument. Shpg. Wt. 1/2 lb.

F-60.....Net ea. 1.98

LOCKE HAND LEVEL



4.45

- Precision Survey Instrument!
- More Than 50% Below Regular Price!

A precision manufactured sighting level — made entirely of brass. Adjustable focus by means of draw tube. Securely mounted prismatic system. Bubble is magnified 4 times for sighting ease. Virtually dust proof. For laying foundations—grading—fences—roads—drains—etc. All preliminary surveys. 5 1/4" long closed. Includes heavy leather case and strap. Shpg. Wt. 2 lbs.

F-137.....Net 4.45

ABNEY CLINOMETER LEVEL



8.95

A finely made surveying instrument of professional quality. Made entirely of brass. The Abney topographic level enables the user to determine ground elevation—measures degrees of slope or inclination—run a level line—etc. Permits preliminary surveying with little or no experience. Fine prismatic system. Arc scale is divided into 60 degrees both sides of zero. Vernier scale reads 1 to 10 minutes. Arc swings from 0 to 96 degrees. Used by farmers—builders—gardeners—caretakers—maintenance men—etc. Particularly useful in laying out drains—retaining walls and fences—driveways—fields—etc. Includes leather case and strap. Imported to save you 50% of regular cost. Shpg. Wt. 3 lbs.

F-138.....Net 8.95

LAFAYETTE CAMERA DIVISION

**WE INVITE COMPARISON!
WE DEFY COMPETITION!!!**

**ALL MERCHANDISE SOLD ON A MONEY
BACK GUARANTEE—YOU BE THE JUDGE.**

ELECTRONIC STROBE FLASH

- LIFETIME FLASH TUBE!
- NO DUDS—NO MISSES!
EVERY TIME!
- COMPACT—ONE PIECE—AC UNIT!
- SUPER-FLASH STOPS FAST ACTION!
- TUBE GUARANTEED FOR LIFE!

Get brilliant Color — sparkling Black and White pictures — every time — with no flash bulb bills! Thousands and thousands of flashes — recycles in 5 seconds! Compact — lightweight — less than many battery units. Fits any camera having standard tripod socket. Supplied with PC cord tip.



F-211 In lots of 3, each **19.95**
Singly, each **21.95**
F-213 — ASA Adaptor tip — In lots of 3, **.29**
Each **.35**
Singly, each **.35**

PORTABLE POWER PACK

Have the advantage of AC operation and complete portability! The Power Pack — using low cost, lightweight flashlight batteries permits flash picture taking anywhere — any time — when used in conjunction with Electronic Strobe Flash F211. Uses four #2 batteries.

F-212 — In lots of 3, each **13.75**
Singly, each **15.00**

BATTERIES FOR POWER PACK

Burgess #2 or RCA V5036 **Net Each .10**

TREMENDOUS TRIPOD VALUE

- REGULAR \$6.95 VALUE!
- LIGHTWEIGHT — LOW COST — STURDY!

Five section sturdy tripod. Extends to 45" — telescopes down to 12 1/2". Weighs a scant 16 oz. Chrome trimmed — head has tension adjust screws for each leg. Fits all tripod sockets. Positive locking action. A "must" to take the "jiggle" out of those special shots. Shpg. wt., 2 lbs.

F-214

\$3.69

FAMOUS MAKE POCKET TRIPOD

- WEIGHS ONLY 10 OZ.!
- ONLY 9" COLLAPSED!

Automatic stop in head prevents overspread. Use with American or foreign cameras by means of a reversible screw. Dural alloy for strength and lightweight. Positive locking action on each section — can't slide in or out! Rubber tipped feet — black ribbed covering. Extends to 45". Shpg. wt., 1 1/2 lbs.

F-219

Net 7.60

PANHEAD — SPECIAL PURCHASE

- INCOMPARABLE AT THIS PRICE!
- PAN TILT WITH A SINGLE MOTION!



1.66

Sturdy brass construction — high polished chrome finish. Camera retaining screw rotates — makes turning camera unnecessary. Weighs only 4 oz. Handle is detachable for compactness. Twist of handle locks both pan and tilt. Pans 360° tilts approx. 145°. Shpg. wt., 8 oz.

F-215

Net 1.66

35 mm Viewer



- Self Illuminating!

Uses the largest lens of any hand held viewer! Lights automatically when slides are inserted. Adjustable magnification—dial controlled telescoping lens. Accommodates all 2x2 slides. Designed for easier handling. Sturdily built to withstand constant use. Our low price includes long-lasting batteries and bulb! Shpg. Wt. 1/4 lb.

F-22

Net 4.85

IMPORTED RANGE FINDER



Leave it to Lafayette! A precision built range finder—for all cameras—extremely accurate! Uses Kodak type-vertically crossed systems. Gives 40% brighter image as compared to super-and meters. Reads from 3 ft. or 1 meter to infinity. Compact—shock-proof—durable construction. Ingenious adapter "foot" to fit accessory shoe on most all cameras. Only 2 1/4 x 1 1/2 x 1/4. Complete with instructions and heavy plastic snap lock case. Shpg. Wt. 12 oz.

F-108

Net 2.49

15 Second Self Timer

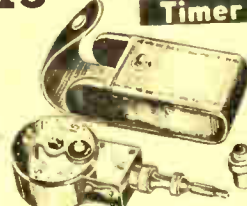

The most popular of all self timers—Fits at Lafayette's popular prices! Fits all cameras and also has special adaptor for Leica-type release sockets. Plug-length adjustable to protect shutter mechanism. Automatically retracts after picture has been taken—permitting film advance and shutter operation without removal. May be used for 15 seconds or less. Extremely compact. Beautiful chrome finish. Individually boxed in genuine leather case.

F-25

Net 1.98

DESK TYPE ELECTRIC SLIDE VIEWER



- For all size slides—from 35 mm to 2 3/4 x 2 3/4.

Makes slide viewing a pleasure! Variable built in adaptor centers all slides for correct magnification. Transparencies are brilliantly illuminated and enlarged through a fine optically ground and polished lens. Electrically operated—equipped with bulb socket on-off switch, 6 ft cord and plug. All steel construction—finished in platinum gray enamel. Shpg. Wt. 2 lbs.

F-26

Net 3.75

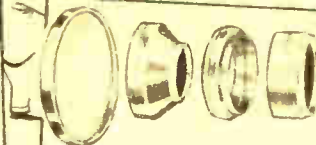

FAMOUS MAKE LENS ACCESSORIES FOR BETTER PHOTOS—AT LOWER COST

PATENTED ADAPTER RINGS

Permits use of any lens accessory in same series. Fits all standard cameras. RANGE B — for lens mounts from 23 to 30.5 mm — Series 5 accessories.

F-225 Range C — for lens mounts from 31 to 36 mm — Series 5 accessories. **Net 1.22**
F-226 Range D — for lens mounts from 36 to 42 mm — Series 6 accessories. **Net 1.22**
F-227 **Net 1.67**

CLOSE-UP LENS

No. #1 for 18" to 38" away, #2 for subjects 12" to 19" away.
F-229 — #1 for Series 5 **Net 2.03**
F-230 — #1 for Series 6 **Net 2.43**
F-231 — #2 for Series 5 **Net 2.03**
F-232 — #2 for Series 6 **Net 2.43**

FILTERS

"A" for using indoor color film outdoors. "F" for using new type "F" Ektachrome indoor film outdoors. "Skylight" (haze) use with color film to reduce haze. "K2" for contrast — cloud effect.

F233 "A" Series 4 **Net 1.29**
F234 "A" Series 5 **1.62**
F235 "A" Series 6 **2.03**
F236 "F" Series 4 **1.29**
F237 "F" Series 5 **1.62**
F238 "F" Series 6 **2.03**
F239 "Skylight" (Haze) Series 4 **1.29**
F240 "Skylight" (Haze) Series 5 **1.62**
F241 "Skylight" (Haze) Series 6 **2.03**
F242 "K2" Series 4 **1.29**
F243 "K2" Series 5 **1.62**
F244 "K2" Series 6 **2.03**

LENS HOODS

Acts as sunshade — reduce glare.
F-245 Series 4 **Net 1.11**
F-247 Series 5 **1.43**
F-247 Series 5-A for Min. Cameras **1.43**
F-248 Series 6 **1.62**

WRITE FOR FREE LITERATURE ON LENS ACCESSORIES

CLAMP — LATEST "GADGET"



- MAKES ANY SURFACE A TRIPOD!
- INGENIOUS; PRECISION PRODUCT OF GERMANY!

Fastens securely to any surface up to 1 1/2" thick. Extra screw for fastening to trees — fences — etc., that are too large for clamp. Head revolves and tilts in all directions. Tripod socket permits use as tilt top on standard tripod. Weighs a scant 6 oz. Slips into pocket. Eliminates need for tripod in many applications. Shpg. wt., 1/2 lb.

F-220

Net 3.29

35mm SLIDE FILE



Portable all steel 35mm slide file. Store 150 2x2 glass slides or 300 2x2 cardboard slides. Includes index card and numbered strips for quick, easy identification. Metal handle and 2 snap catches. Finished in platinum gray enamel. Shpg. Wt. 3 lbs.

F-161

Net 1.98

TILT-TOP



only
1.39

Precision made—all brass—heavily chrome plated. All-angle "Tilt-Top" fits German and American Tripods and Cameras. Positive locking action at every possible angle. Inexpensive — indispensable accessory. Shpg. Wt. 8 oz.

F-160

Net 1.39

LAFAYETTE MAKES PHOTO HISTORY

TWIN-LENS FOCUSING REFLEX CAMERA LATEST MODEL! — LOWEST PRICE!

TWO F3.5/80 HARD COATED LENSES • FLASH SYNCHRONIZED SHUTTER!
• 9 SPEEDS: to 1/200 SEC.!

• ACCEPTS 120 ROLL FILM
• FINGERTIP FOCUSING! • DOUBLE EXPOSURE PREVENTION!

An outstanding-precision mode reflex camera for brilliant color or black and white! Shutter speeds of 1/200, 1/100, 1/50, 1/25, 1/10, 1/5, 1/2, 1 sec. and Bulb. 12 large 2 1/4" x 2 1/2" prints on 120 roll film. Built in flash synchronization — PC terminal precision coupled focusing-never on out of focus picture. Brilliant ground glass viewfinder highly corrected F3.5/80 coated lenses give superb definition. One flip erects or shuts hood — F22. Has etched depth of field and distance scale easily visible from above. Standard cable release socket. Rugged all metal covered body has tripod socket. Focuses from 3 1/2 feet to infinity. The genuine leather Eveready case includes both end and shoulder straps. Built in strap guider on camera for suspending when not in case. Of course Lafayette's usual "Satisfaction or your money back" guarantee applies to this fabulous value 4 lb. Lens mount is 36 mm. Lens Case, Shpg. wt. F-205

F-206 — Leather Eveready Case Net 19.49

Three Piece Outfit—camera above— Net 3.95

Leather Eveready Case — Collapsible

flash gun.

F-207

Net 26.39



FOLDING BC POCKET FLASH

• LAFAYETTE SPECIAL PURCHASE!
• FOLDS LIKE A FAN TO 4" x 2"
• EFFICIENT B-C OPERATION!

Brand new — unique — pocket size — completely folding. Flash unit of Lafayette's famous low-cost Efficient 4 1/2" diameter metal reflector has pebbled finish to eliminate hot spots. B-C combination for surefire and hi voltage. Heavy molded battery case with built in test lamp — bulb ejector — extension socket. Standard shoe bayonet base adjust fits accessory clips. Uses standard bayonet base flash bulbs. Novel, useful exposure guide built in on rear of case. Complete with cord for PC fitting and condenser. Shpg. wt. 1 lb.



Net 3.99

F-209 Complete with leather case.

COLLAPSIBLE FLASH GUN

• USE WITH ANY SYNCHED CAMERA • FLASHLIGHT BATTERY OR B-C

Mounts on any camera — use with accessory clip or bracket included. Made in Germany of light weight aluminum — collapses to fit gadget bag with ease. Use with two #1 cells or B-C pack plus 22 1/2 Volt battery. Shpg. wt. 1 lb.

F-145 with ASA Tip Net 3.59

F-146 with PC Tip Net 3.59

F-147 BC Pack Net 1.89

Burgess U-15 or RCA VSO84 22 1/2 Volt BC Battery .98

Burgess #1 or RCA VSO35 1 1/2 Volt Battery .10



PHOTO ELECTRIC EXPOSURE METER

• Typical West German quality at Lafayette's typical down-to-earth prices!

Here is a versatile, easy to use high quality exposure meter produced with jewel-like precision by skilled craftsmen. Complete range of shutter speeds—from 1/1000 second to 2 min., stops from F2 to F22, speed ratings from 10 to 100 ASA. One control to set-point meter at subject—needle indicates correct exposure time—diaphragm reading appears in same window. Simultaneous movie reading of 8-16-32 and 64 frames. Designed for outstanding speed and simplicity of operation. Extremely sensitive and accurate. Net weight less than 4 ozs. Inlaid panels of leather—satin chrome trim. Compact 3 1/4" x 2 1/4". You must agree our price is half the cost of other meters of such fine design and construction. Ever-ready leather carrying case and flexible metal neck chain are available optionally. Shpg. Wt. 1/2 lb.

F-27 EXPOSURE METER Net 8.75

F-28 Leather case. Net 1.79

F-29 Neck chain Net 1.59



AMPLEX PHOTOFLASH FLASH BULBS



• LOWEST PRICES—HIGHEST QUALITY GUARANTEED FOR PERFORMANCE

• ALL STANDARD BAYONET BASE

• "MY-T-MYTE" AND "SYNCHRO SURE" PHOTOFLASH BULBS

• THE CHOICE OF PROFESSIONALS — A MUST FOR AMATEURS

LAMP TYPE	CLASS	CARTON QUAN.	PER CTN.	EA. IN LOTS 3 CTNS.	EA. IN LOTS 6 CTNS.	COMPARABLE LAMP TYPE
PF2*	M	12	.84	.80	.75	
SM	F	10	1.02	.97	.92	
5	M	10	.90	.84	.78	SF
5B**	M	10	1.12	1.05	.93	Press 25
6	FP	10	1.12	1.05	.93	25B FP-26

*New super midget — no adapter needed.

**For use with daylight color film without filters.

STEREO CAMERA

Complete Outfit

3 DIMENSION HI-FI PHOTOS

Reg. List
29.95

• Takes single pictures - or Stereo
• Ruggedly constructed - Simple to use
• Complete with Flash Unit - 3D Viewer - Frames - Leather Case - Straps!

Leave it to Lafayette! Never before — a complete 3-D Camera Kit at a price as low as ours! Now anyone can capture the fullness — depth — detail — and vivid colors of life-like stereo pictures. 3-Dimensional precision add Hi-Fidelity to Photography! Uses standard size 127 film — takes 4 stereo pairs or 16 single pictures. Matched, coated 15mm lenses — fixed focus, F8 and F16 stops. Built-in flash synchronization. Speeds 1/20th and bulb. Shutter cocking lever prevents double exposure. Lightweight body covered with black leatherette — trimmed with brushed aluminum. Genuine leather eveready case and straps. Collapsible optical viewer folds flat to fit pocket — purse — or gadget bag. As simple to use as a box camera. You get the 3-D Camera - leather case - straps - flash gun - 3-D Viewer - and frames. Shpg. wt. 3 lbs.

F-179

Net 9.95

F210 — Frames for Stereo Viewing. Pkg. of 12

Set .39



9.95

Lafayette CAMERA DIVISION Saves you more than 50%
 WORLD WIDE PURCHASING POWER Imported Direct to save YOU Money!



Exclusive!

F2.8 Lens

ONLY \$34.95

Coupled 'RANGEFINDER 35'

- MORE QUALITY FEATURES THAN CAMERAS SELLING FOR DOUBLE THIS PRICE!
- REGULAR VALUE \$69.50

- ✓ BRILLIANT COMBINED VIEW-RANGE FINDER! ✓ SINGLE STROKE RAPID FILM TRANSPORT!
- ✓ NINE SHUTTER SPEEDS TO 1/300!
- ✓ MXF SYNC-ALL SPEEDS — ALL BULBS — PLUS STROBE!
- ✓ F2.8 45mm COATED LENS!
- ✓ HI-SPEED REWIND!
- ✓ STANDARD PC FLASH TERMINAL!
- ✓ DOUBLE EXPOSURE PREVENTION!
- ✓ BUILT-IN SELF TIMER!

Lafayette's outstanding camera value! Precision-made to order for the camera fan who is a wise buyer. Check the features — then compare Lafayette's price with any other brand. Fast F2.8 coated anastigmat lens and extra-wide lens aperture for brilliant, sharper full color or black and white even in poor light. Sight and focus through combined range-view finder. Fully synchronized at all speeds for class F, M and electronic flash. Speeds from 1 sec to 1/300th. Rapid advance s-rs shutter, counts exposure and transports film. Built-in delayed action timer — automatic exposure counter and film stop. Hi-speed rewind with folding lever. Standard accessory shoe on top-film type indicator. All metal body with brushed chrome trim-block leatherette covering. 20 or 36 exposures on black and white or color 35mm film. PG flash terminal. Lens mount diam. 35.7 mm. Shpg. wt. 3 lbs.

- F-196 Less case. Net 34.95
- F-197 Leather Eveready Case. Shpg. wt. 1/2 lb. Net 3.95
- Three piece outfit — camera above — Eveready case — and folding BC flash gun. Shpg. wt. 4 1/2 lbs. Net 41.85
- F-198. Net 41.85

Completely NEW! Exclusive Import
SAVE \$33.00 SPECIAL PURCHASE

- DOUBLE EXPOSURE PREVENTION
- F3.5 HARD COATED LENS
- SHUTTER SPEEDS TO 1/200th
- BUILT IN FLASH SYNCHRONIZATION
- AUTOMATIC FILM STOP AND EXPOSURE COUNTER
- OPTICAL EYE LEVEL VIEWFINDER
- RAPID FILM ADVANCE

Has everything you need for fast, accurate shooting. Designed to fit your needs — priced to fit your budget. Many features found in the most expensive cameras. Quality design coupled with ease of operation. Fast F3.5 hard coated anastigmat lens for full color or black and white. Speeds of 8, 1/25, 1/50, 1/100 and 1/200 sec. Synchronized for flash unit. Automatic exposure counter. No double exposure — film advance pre sets shutter. Cable release socket. Depth of field scale permits easy snapping of objects at different distance within the "in focus range". Detachable back, accessory shoe. Tripod socket. All metal body finished in brushed chrome and black "Morroco". PC flash terminal. Lens mount diameter 31.8 mm. Less case. Shpg. wt. 2 1/2 lbs.

- F-199 Net 19.50
- F-200 Leather Eveready Case. Shpg. wt., 1/2 lb. Net 2.95
- Three piece outfit — camera above — Eveready case — and folding BC flash gun. Shpg. wt. 4 lbs.
- F-201 Net 25.49

\$19.50



Latest Model LOWEST PRICE EVER!

FAMOUS BEAUTY 35

ONLY \$22.95

- NINE SPEEDS—FROM 1 SEC TO 1/300 PLUS BULB!
- RAPID TRANSPORT LEVER!
- BUILT-IN FLASH SYNC!
- BUILT IN SELF TIMER!
- LEICA TYPE CABLE RELEASE!
- DIRECT OPTICAL "TRIMMING TYPE" VIEW FINDER
- 45mm F3.2 COATED ANASTIGMAT LENS!
- FOLDING FILM REWIND LEVER!

- DOUBLE EXPOSURE PREVENTION!

Lafayette invites comparison of this camera to any selling at twice our price! You must be satisfied or your money will be refunded! An outstanding example of precision design and simplicity of operation. F 3.2/45 coated triplet lens. Front type 5 blade shutter has speeds of 1, 1/2, 1/3, 1/10, 1/25, 1/50, 1/100, 1/300 sec and bulb. One easy motion of this transport lever sets the shutter, counts the exposure, prevents double exposure, and transports film! You can shoot time after time — without taking your eye from the view finder. Also features accessory clip, body shutter release, film indicator depth of field scale, completely opening back, lens cap, focus down to 3.5 ft weighs only 18 oz. Black leather and satin chrome trim, 36 exposures, PC Terminal. Lens mount 29mm. Less case. Shpg. wt., 2 1/2 lbs.

- F-202 Net 22.95
- F-203 Leather Eveready Case. Shpg. Wt., 1/2 lb. Net 3.95
- Three piece outfit — camera above — Eveready case — and folding BC flash gun. Shpg. wt., 4 lbs. Net 29.39
- F-204 Net 29.39



OUTSTANDING VALUES

SPORTSMAN'S COMBINATION KNIFE

3.25

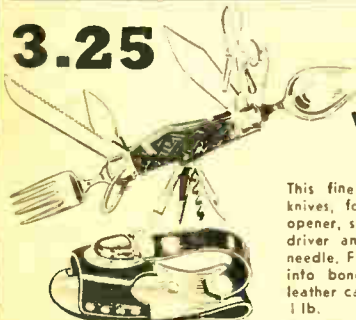

in genuine leather case

**A COMPLETE
12 PIECE
CAMPING KIT
WORTH 3 TIMES
THE PRICE**

This fine imported camping kit contains 2 knives, fork, spoon, scissors, can and bottle opener, saw and fish scaler, awl punch, screw driver and file, corkscrew, and a sailmaker's needle. Fine steel blades. All tools fold neatly into bone handle 4 1/2" long complete with leather carrying case with belt loop. Shpg. wt. 1 lb.

F-148..... Net 3.25

IMPORTED MARCHING COMPASS



2.45

Made in Germany by the leading European compass manufacturers. Indispensable for campers, hikers, hunters, tourists, etc. Same type as those extensively used by the armed forces to determine one's position in unknown country. Jeweled needle—luminous cardinal points—rotating twin scale, 0-64 and 0-360—sighting line and mirror for accurate bearings—locking device—setting edge calibrated in millimetres—rugged, ebony finish case. Can also be used to measure the width of an objective. Complete with instructions.

F-115..... Net 2.45

SWISS ARMY KNIFE

**A 12.50 VALUE
FOR**

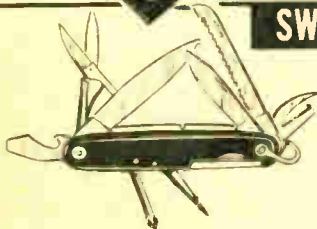

3.75 only

Made in Solingen, West

Germany, of super fine steel. Holds edge sharp enough to shave with! Finest hunting, fishing, and all 'round sporting AID made! Includes a 2 3/4" saber type blade, 1 3/4" utility blade, standard screw driver, Phillips screw driver, 3" compound toothed saw blade, reamer-punch-awl blade, can opener, bottle opener, and pair of fine quality scissors. Withstands the roughest treatment. Fine Solingen Steel assures years of dependable service. Shpg. wt. 1 lb.

F-121..... Net 3.75

POCKET GENERATOR FLASHLIGHT

- NO BATTERIES — EVER!
- ALWAYS READY TO OPERATE!

The perfect pocket flashlight for home—car—or to carry with you. Plenty of bright light just by successive activation of generator level. No batteries to carry or go dead. Balanced flywheel generator for ease of operation. Only 2 3/4" x 1 1/2" x 1 1/2", slips easily into pocket or purse. Never wears out. Ideal for campers—tourists—motorists. Weighs only 6 ozs. Made in Germany.

F-169..... Shpg. wt. 1 lb. NET 3.79



BINOCULAR MOUNTING CLAMP

Indispensable accessory for high powered binoculars. Fits all sizes—individual or central focus. Used with standard camera tripod. Cannot scratch or damage finest binoculars. Holds binoculars steady for long range—extended period use. Light alloy construction—satin black finish. Shpg. wt. 1/2 lb. F-187

NET 1.85

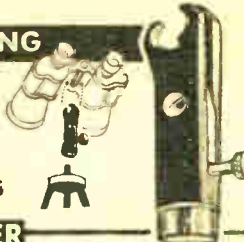

MAP MEASURER & COMPASS

- Not a gadget—but a real instrument.
- Measures distances on any size map.
- Measures curved or irregular shapes.

Exclusive at Lafayette! A map measurer with built-in compass! For the motorist—camper—hunter—boating enthusiast. An indispensable unit of equipment. Just trace along route on map and multiply miles—per inch factor by reading on dial. Also reads directly in inches up to 39". Built-in magnetic compass has cardinal and secondary points—full 360° markings; in tenths. Accurate and dependable. Complete with leather sheath. Shpg. Wt. 8 oz.

F-47..... Net 1.59



IMPORTED BINOCULARS

With Coated Achromatic Lenses and Prisms

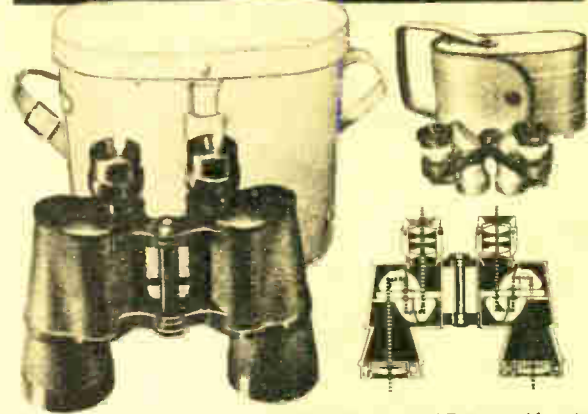

Lafayette has gone "all-out" to present these fine, imported Zeiss type binoculars at heretofore unheard of prices! Each of these extremely precise optical instruments have coated lenses—clamped in (not just glued!) prisms—light weight alloy all metal bodies—weather proof, tear proof outer coverings—maximum light transmission—minimum distortion. Made by leading optical manufacturers to our own rigid specifications. Whether you are a yachtman—hunter—hiker—sports fan—or a bird watcher—you'll find the binoculars you need in Lafayette's great selection. And Lafayette's famous money-back guarantee applies as always.

Quality Guaranteed for One Year
AGAINST MECHANICAL AND OPTICAL DEFECTS.

FOCUS—mechanism is either central focus (C.F.) by means of a single wheel and one adjustable eye piece, or individual focus (I.F.) wherein both eye pieces are separately adjustable.

POWER—is the number of times an image is magnified through your binoculars. For example 7X (7 power) means the object will appear 7 times larger (or closer) than with the naked eye. The second number used (i.e. the "50" in 12X, 50) is the diameter in millimeters of the objective lens.

COATED LENSES—tend to reduce reflection and pass up to 50% more light than uncoated lenses.

F-182	— 8x, 15 I.F.	Includes Hard Peshkin case	Shpg. Wt. 2 lbs.	NET 10.75
F-105	— 8x, 30 I.F.		Shpg. Wt. 3 lbs.	NET 14.95
F-15	— 7x, 35 I.F.		Shpg. Wt. 3 lbs.	NET 17.95
F-183	— 7x, 35 C.F.		Shpg. Wt. 3 lbs.	NET 20.95
F-184	— 7x, 35 C.F.	Wide Angle—Shpg. Wt. 3 1/2 lbs.		NET 29.50
F-103	— 7x, 50 I.F.		Shpg. Wt. 3 1/2 lbs.	NET 21.50
F-164	— 7x, 50 C.F.		Shpg. Wt. 3 1/2 lbs.	NET 24.95
F-104	— 12x, 50 C.F.		Shpg. Wt. 4 1/2 lbs.	NET 27.95
F-118	— 16x, 50 C.F.	Extra Light Weight—Shpg. Wt. 3 1/2 lbs.		NET 31.50

Add 10% Fed. Tax to Above Prices

NAUTICAL BRASS BAROMETER

REGULAR
\$10.00
VALUE

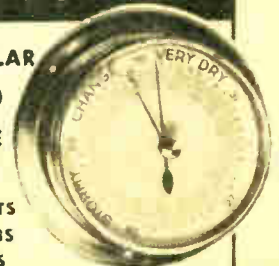

- BOATS
- CLUBS
- DENS

Fine, imported brass barometer—specifically designed for boats—equally at home in your living room or den. Silvery dial with fine black markings. Reads "Stormy—Change—Very Dry"—measures from 27" to 32" with subdivision of 0.1. Has third scale divided from 900 to 1065 millibars. Beveled crystal face 3/4" in dia., 4" dia. back flange with three mounting holes, 1 1/2" deep overall. Highly polished nautical brass case. Adjustable for local height above sea level by means of screw at rear. Shpg. Wt. 1 lb.

F-165..... Net 4.75

JEWELLED NEEDLE & COMPASS

Here's a precision compass by a famous compass manufacturer—each compass is made by precision craftsmen and assures dependable accuracy. Heavy brass case is nickel plated and highly polished. Hinged cover, 1 3/4" beveled crystal face, swivel carrying ring. Metal scale fully calibrated, has luminous marking at cardinal points. Needle is suspended on a jeweled bearing—has luminous tip. Locking device holds needle in position—highly polished inner band permits reading from any angle.

F-12..... NET 9.94



LAFAYETTE'S EASY TO BUILD KITS

Enjoy the VERY BEST and YOU save more!

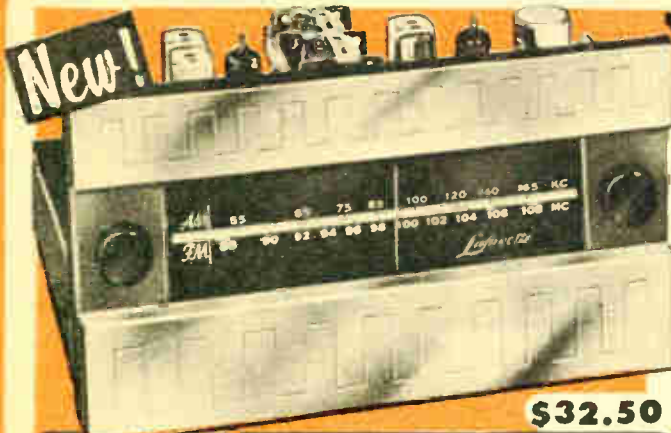

FM-AM TUNER KIT

- AFC DEFEAT CIRCUIT WITH FRONT PANEL CONTROL
- FOSTER-SEELY DISCRIMINATOR CIRCUIT
- GROUNDED GRID TRIODE AMPLIFIER • 20-20,000 CPS RESPONSE

Choose this 7 tube compact high-fidelity FM-AM tuner whose characteristic features are found in units costing many times as much, and whose performance is unheard of at this low price. There are two front panel controls, a function control for AM, FM, PHONO and a tuning AFC defeat control. Automatic frequency control for fast accurate tuning can be momentarily disabled to allow tuning weak stations adjacent to stronger ones. Features Armstrong FM circuit with limiter and Foster-Seely discriminator. The low noise front end consists of triode grounded amplifier and separate mixer and oscillator. The AM superheterodyne receiver has a low noise built-in ferrite loopstick and high impedance terminal for external antenna. Simplified tuning with slide-rule dial and flywheel counterweighted mechanism, high impedance phono input and high impedance audio output.

SPECIFICATIONS

FREQUENCY RANGE: FM, 88-108MC, AM, 530-1650 KC, ANTENNA INPUT: FM, 300 ohms, AM, Ferrite loopstick and high impedance external antenna. DISTORTION: Less than 1% of rated output. FREQUENCY RESPONSE: FM, \pm .5 DB 20 to 20,000 cps, AM \pm 3 DB 20 to 5000 cps. SENSITIVITY: FM, 5 UV for 30 DB quieting, AM, Loop sensitivity 80 UV meter. SELECTIVITY: FM, 200 KC bandwidth, 6 DB down; 375 KC FM discriminator peak to peak separation, AM, 8 KC bandwidth, 6 DB down. IMAGE REJECTION: 30 DB minimum. HUM LEVEL: 60 db below 100% modulation. TUBE COMPLEMENT: 2-12AT7, 1-6BE6, 1-6BA6, 2-6AU6, 1-6AL5 plus selenium rectifier. SIZE: 5 1/2" high x 9 3/4" deep (excluding knobs). CONSUMPTION: 30 watts. For 110-120V 60 cycles AC. Attractive copper plated and lacquered finish. Less metal case. Shpg. wt., 9 lbs.

KT-100

ML-100 Metal case for above. Shpg. wt., 3 lbs.

Net \$32.50

5.00

\$32.50

BASIC FM-AM TUNER HAVING OUTSTANDING SPECIFICATIONS AND DELIVERING ASTONISHING PERFORMANCE — ALL AT A BUDGET PRICE IN EASILY ASSEMBLED KIT FORM

NON-RESONANT PROFESSIONAL TRANSCRIPTION TONE ARM

A TONE ARM DESIGNED FOR OPTIMUM PERFORMANCE ON BOTH MICROGROOVE AND STANDARD RECORDS

- SOLDERLESS INSTANT PLUG IN CARTRIDGE CHANGE FOR PICKERING, GE, FAIRCHILD, AND MOST STANDARD CARTRIDGES
- SENSITIVE TRACKING FORCE ADJUSTMENT
- HEIGHT AND COUNTERBALANCE ADJUSTMENT
- PERFECT TRACKING OF LONG PLAYING AND STANDARD RECORDS WITH A MINIMUM NEEDLE PRESSURE

A new tone arm characterized by the absence of low frequency tone arm resonance, perfect tracking, high compliance, elimination of record and stylus wear and ease of handling. The center of gravity is located at the precise ball bearing horizontal revolution shaft which minimizes the vertical mass and permits the arm to work smoothly and lightly. A dynamically balanced pivot enables free vertical movement resulting in perfect tracking with minimum needle pressure on either LP or standard records. The effect of shocks is minimized and groove jumping and skipping is virtually eliminated. Badly warped records can be played with excellent results. Slide-in cartridge holders simplify the insertion and removal of all standard cartridges, with spring clip contacts eliminating soldering. A weight and tracking force adjustment permit variations in needle pressure. Height adjustments of both the tone arm and pickup rest are possible. The base has built-in self leveling screw adjustments. Complete with cordidge adapters and an adjusting weight. Less cartridges. Distinctive harmonics finish. A regular \$51.50 value, this item is imported to save you money. Shpg. wt., 3 lbs.

PK-104

Net \$3.95



Reg Value \$51.50
Net \$3.95

Lafayette Radio

FAMOUS IN RADIO FOR 36 YEARS

To Speed Shipment on Your Order Please Mention

CATALOG 5-56

Include sufficient money for postage. We refund unused amounts.

NEW YORK 13, N. Y., 100 Sixth Ave.

Receptor 2-8600

BRONX 58, N. Y., 542 E. Fordham Rd.

Fordham 7-8013

NEWARK 2, N. J., 24 Central Ave.

Market 2-1661

PLAINFIELD, N. J., 139 West 2nd St.

Plainfield 6-4718

BOSTON 10, MASS., 110 Federal St.

Hubbard 2-7850

Our Big Showrooms Open Evenings:

BRONX } open Thursdays
PLAINFIELD, N. J. } till 9:00 P.M.

NEWARK, N. J. — open Wednesdays till 9:00 P.M.
BOSTON — open, Mondays till 9:00 P.M.

New!

TRIPLE PURPOSE SLIM CRYSTAL MICROPHONE

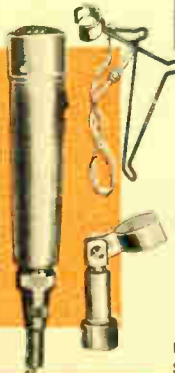

- May be hand-held, stand mounted or suspended by lavalier cord!
- Frequency 50-10,000 CPS
- On-Off Switch

A tremendous value! Unique design, only 4 1/2" L x 1 1/8" diam. Comes complete with swivel adapter to fit all standard mike stands, and lavalier cord and bracket which leaves both hands free. Smooth wide range response. Locking type on-off slide switch. Detachable 7 ft. cable and connector. Shpg. wt. 2 lbs.

PA-31

Each in lots of 3 5.65
Singly, Each 5.95

LAFAYETTE RADIO

100 SIXTH AVE., NEW YORK 13, N. Y.

Return Postage Guaranteed

BULK RATE

U. S. POSTAGE

PAID

New York, N. Y.

Permit No. 8486

LAWRETT V. TACKETT
42 SHOPPING COURT
DAYTON 3 OHIO

HC-6-55

FORM 3547 REQUESTED